



PLUMBING SPECIALTIES

PASCO has been manufacturing and distributing high quality plumbing specialty items since 1936. We were the originator of what are now considered to be common specialty items. These items include packaged closet bolt sets, first introduced to the trade in 1956. In 1966 PASCO was the sole driving force to get rubber dishwasher drain hose written into the plumbing codes throughout the United States. Since that time, this product alone has saved plumbers countless hours of labor in the installations of dishwashers. More recently we have brought to the market another time saving item for the plumber, the patented Quick Ring which repairs broken closet flanges.

The professional plumber requires professional products. PASCO has for years been committed to providing items which the plumber demands.





PLUMBING SPECIALTIES INDEX

Add-a-shower Riser Brackets	B-43
Add-a-shower	B-41
Adjustable Shower Arm	B-38
Aerators	B-25,26
Amstan Style Lavatory Hanger	B-31
Anchor Sets	B-48
Anti-siphon Ballcocks	B-16
Ballcock Coupling Nut	B-17
Ballcock Shank Washer	B-19
Basket Strainers	B-27,28,29
Bath & Tub Waste Shoe	B-40
Bath Supplies	B-34
Bathcock Coupling	B-34
Bead Chain	B-40
Branch Tailpieces	BT-9
Brass Closet Bolt Sets	B-4
Brass Pop-up Assemblies	B-22
Brass Twin Ell	B-34
Brass Utility Drain	B-44
Brass Waste Connectors	B-23,24
Candle Wicking	B-21
Cast Swivel Trap	BT-10
Cast Tees W/ Tailpieces	BT-3
Ceiling Supports	B-43
Closet & Urinal Spuds	B-16
Closet Bolts, Screws, Nuts, Washers	B-6,7
Closet Bowl Wax Gasket	B-8
Closet Ells	BT-9
Closet Flange Extension Kit	B-8
Closet Flange Extension	B-8
Cloth Inserted Rubber Washers	B-9
Commercial Lav Drain	B-22
Compression Rings	B-24
Concrete Anchors	B-48
Cone Filter Washer	B-19
Cone Slip Joint Washers	B-21
Continuous Wastes	BT-4
Copper Supply Tubing	B-24
Copper Thermocouples	B-51
Crumb Cup Strainer	B-22
Cut Length Oakum	B-48
Dishwasher Air Gap	B-3
Dishwasher Connector Kit	B-3
Dishwasher Drain Hose	B-3
Disposer Kit	BT-9

Diverter Spout Lift Replacement	B-38
Diverter Spout	B-34
Douglas Flush Valve Washer	B-20
Drive Screws	B-48
Dryer Duct Clamp	B-47
Dryer Duct	B-47
Earthquake Strap	B-51
Extension Tube	BT-6,7,8
Face Bushings	B-38
Faucet Hole Covers	B-30
Faucet Stem Washer Assortment	B-21
Felt Pipe Wrap	B-48
Flanges	B-43
Flappers	B-13,14
Flat Head Woodscrews	B-48
Flex-a-Flange	B-8
Float Rods	B-15
Flush Valve Guides	B-15
Flush Valve	B-15
Four Way Key	B-51
Friction Rings	B-18
Garbage Disposer Shield	B-21
Garden Hose Washer	B-19
Garden Hose	B-3
Generic Replacement Parts for Price-Pfister Faucets	B-52,53,54,55
Granulated Carbon Filter	B-56
Graphite Packing	B-21
Handicap Style Lav Drain	B-22
Heater Furnace Loglighter Keys	B-51
Hex Nut	B-9
Hex Screw & Nut Setter	B-50
High Rise Shower Arm	B-37
Hose Clamps	B-3
Hose Faucet Anchor	B-2
Ice Maker Hook Up Kits	B-56
J Nail	B-50
J-Bends	BT-2
Kitchen Sink & Spray Head	B-26
Lav Drain	BT-10
Lavatory Coupling Nuts	B-17
Lavatory Hanger	B-31
Lavatory Legs	B-30
Lift Wires	B-15
Lock Nuts	B-17

Los Angeles Code Sink Trap	BT-3
Mack Washer	B-20
O-ring Kit	B-21
Overflow Plate & Bolt	B-39
Overflow Plate	B-40
Overflow Tubes	B-15
Pipe Straps	B-50
Plastic Dryer Vent Hood	B-47
Plastic Louver Dryer Vent Hood	B-47
Plastic Shower Drain	B-44
Poly Washers for Tailpieces	B-19
P-Traps	BT-1
Quick Ring	B-1
Quick Set Shower Drain	B-44
Quick Valve Plate	B-39
Repair Couplings & Ells	BT-8
Replacement Strainers	B-22
Replacement Toilet Tank	B-10
Rod Couplings	B-48
Rosettes	B-30
Seat Hinges	B-15
Self Nailing Protection Plate	B-50
Self Piercing Needle Valve	B-56
Self-drilling Screws	B-48
Semi Cast Traps	BT-10
Setting Tools	B-48
Sheet Metal Screws	B-48
Shower Arm Ells	B-34
Shower Arm Flanges	B-38
Shower Arm Shut Off	B-37
Shower Arms	B-37
Shower Curtain Pins	B-43
Shower Heads	B-37
Shower Rods	B-42
Shower Valve Rebuild Kits	B-35,36
Sillcock Key	B-51
Sink Tailpieces	BT-6
Sink Traps	BT-2
Slip Joint Elbows	BT-9
Slip Joint Nut Sets	B-18
Slip Joint Nuts	B-18
Slip Joint Repair Traps	BT-9
Slip Joint Washers	B-19
Soap Dispenser	B-21
Solder Collars	B-17
Split-one Floor/ceiling Plates	B-46
Sponge Rubber Closet Bowl Gaskets	B-8
Spud Friction Rings	B-20
Spud Washers	B-20
Steel Closet Bolt Sets	B-5
Steel Eye Sockets	B-50
Stove Bolts	B-48
S-trap W/ Flanges	BT-3
Sure Grip Flanges	B-45
Tailpiece Washer	B-19
Tank Floats	B-15
Tank To Bowl Bolt Sets	B-9
Tank To Bowl Bolts	B-9
Tank To Bowl Connector Kit	B-9
Tank-to-bowl Gaskets	B-19
Toggle Bolts	B-48
Toilet Stabilizer Shim	B-9
Toilet Tank Trip Levers	B-11,12
Tub Spouts	B-32,33
Tub Strainer	B-40
Urinal Outlet Spud	B-16
Wall Bend For P-Trap	BT-1
Wall Hung Urinal Spud Washer	B-20
Waste & Overflow Washers	B-20
Waste Arm Cover Tube	B-24
Waste Arms	BT-5
Wire Pipe Hooks	B-50
Z Hanger	B-31





QUICK RING

Replaces ANY Closet Ring!

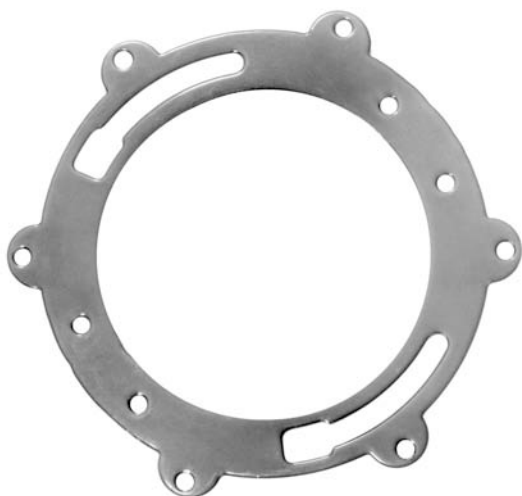

United States Patent 5,890,239
Unique screw tabs attach to wood or concrete.
Plastisol coat provides corrosion protection.
Slotted for 1/4" or 5/16" closet bolt.
Old closet ring does not need to be present.
Replaces any and all closet rings.

INSTALLATION INSTRUCTIONS

FOR SOLVENT WELDED STEEL/PLASTIC COMBO AND PLASTIC CLOSET RINGS

Remove portion of broken ring, if remaining portion cannot be removed, Quick Ring will mount on top.

Apply a bead of butyl rubber caulk to the underside of the Quick Ring that will mount on top of the old ring.

Set Quick Ring on top of remaining portion of old ring. Note location of old toilet bolt slots. The length of the bolt slots in the Quick Ring allows for some centering of toilet. Secure the Quick Ring to wood or concrete sub floor with screws or anchors.

FOR CAST IRON RINGS

The Quick Ring can be mounted directly on top of an old cast iron closet ring. Drill holes in any remaining portion of cast iron ring that corresponds with holes in Quick Ring. Before securing the Quick Ring with screws, apply a bead of butyl rubber caulk to its underside. Large gaps or spaces around or underneath the closet ring, can be filled with any quicksetting type grouts, cements, etc.

PLEASE NOTE:

When setting the toilet use a wax bowl ring with plastic flange.

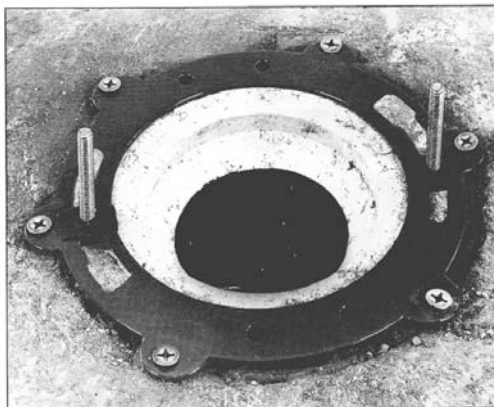

**PART
NUMBER**

21013



A QUICK, EASY, LONG LASTING
solution to loose exterior faucet's
HOSE FAUCET ANCHOR

There's never been a quick, easy lasting way to secure an exterior faucet till the patented Hose Faucet Anchor.

- Works with any wall material (brick, concrete, vinyl, or stucco)
- Repair or new home applications
- 5 Minute installation that lasts
- Fits all exterior or faucet water lines
- Corrosion free

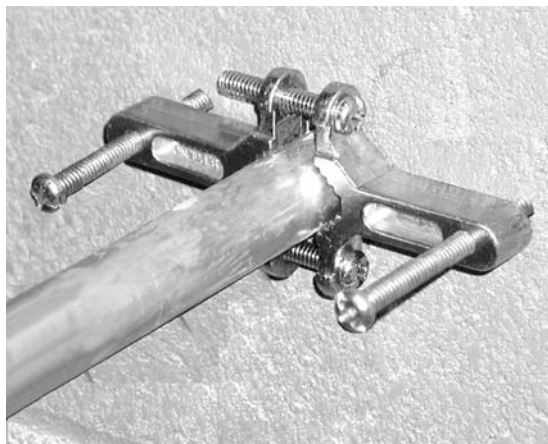

How to mount your Hose Faucet Anchor

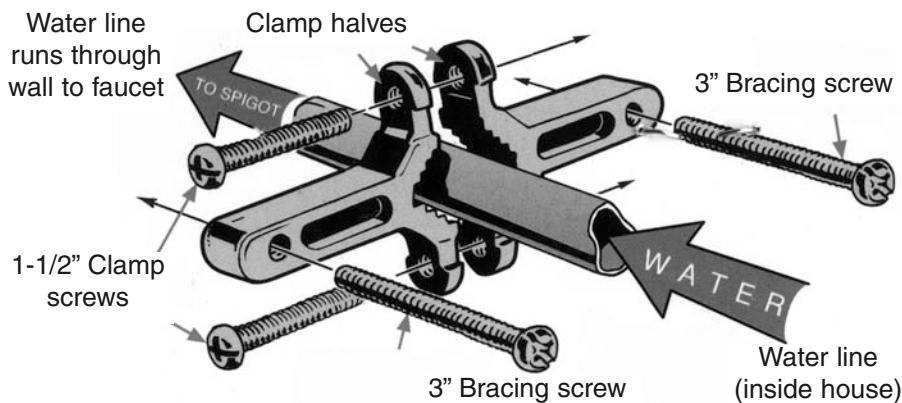

Loosely assemble clamp halves around the hose faucet water line on the inside of the wall using the shorter (1 1/2") screws. Slide the clamp on the pipe approximately 1" from the wall and tighten the 1 1/2" clamp screws securing the clamp to the pipe.

Thread the 3" bracing screws into the "wing" ends' threaded holes facing you. Run these screws in until they contact the wall with equal pressure

Tighten these screws alternately and equally until the faucet is secure. The screws may dig into the wood or masonry material behind the house faucet anchor. This prevents any twisting action of the house faucet when turning it on and off. Now go outside and enjoy trouble free hose faucet security

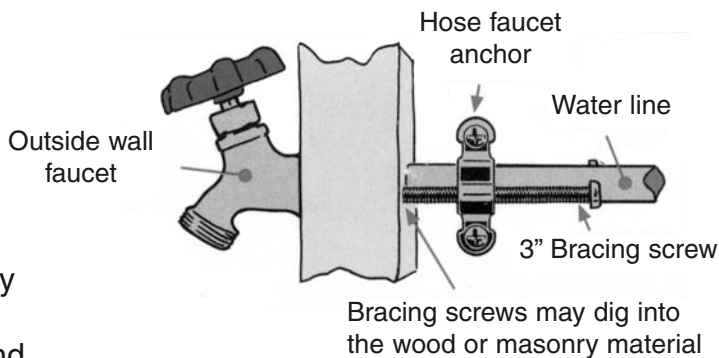

PART NUMBER
5023



DISHWASHER DRAIN HOSE

PASCO Invented Dishwasher Drain Hose!

SINCE 1966

Our hose is made of braided rubber with a rayon tire grade cord. It is an extremely durable hose and resists kinking.

Meets AHAM Standard DW-1
Listed in Table A of the UPC



PART NUMBER	SIZE	LENGTH
50650	5/8"	50'
50750	7/8"	50'

Order by the roll

KINK-FREE GARDEN HOSE

Water flows always - Heavy duty



PART NUMBER	SIZE	LENGTH
560	5/8"	50'

REINFORCED GARDEN HOSE

3 Ply - Nylon Vinyl - Braided
Retains full flexibility down to 0° F.



PART NUMBER	SIZE	LENGTH
531	5/8"	50'
532	5/8"	75'
536	3/4"	50'
555	5/8"	50' 2 ply

GARDEN STANDARD HOSE

Unbraided
Uniform thickness & strength

PART NUMBER	SIZE	LENGTH
514	1/2"	50'

DISHWASHER AIR GAP

White polypro body with chrome plated ABS top
UPC listed
*Contains air gap, 7/8" x 24" dishwasher drain hose and 3 clamps



PART NUMBER	SIZE
50710	Air Gap Alone
50712	Air Gap w/ Hose*

DISHWASHER CONNECTOR KIT



Rigid construction
Will not collapse

PART NUMBER
496

HOSE CLAMPS



Apply with # 558
Hose Clamp Pliers
Self tightening

PART NUMBER	SIZE
A-15	5/8"
A-20	7/8"



PART NUMBER	SIZE
60010	5/8"
60016	7/8"



PACKAGED **BRASS** CLOSET BOLT SETS

Brass Bolts With Nuts & Washers

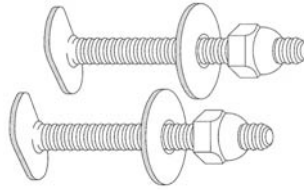

PART NUMBER	s2 Brass Bolts 2 NP Brass Nuts 2 Plated Steel Washers
100	1/4" x 2-1/4"
94	1/4" x 3-1/2"
82	5/16" x 2-1/4"

Brass Bolts With Nuts, Washers & Steel Speed Nuts

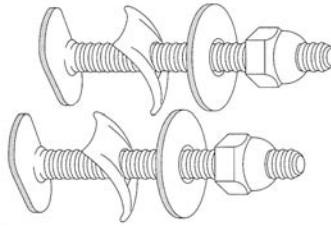

PART NUMBER	2 Brass Bolts 2 NP Brass Nuts 2 Plated Steel Washers 2 Steel Speed Nuts
102	1/4" x 2-1/4"
107	1/4" x 3-1/2"
59	5/16" x 2-1/4"

Brass Bolts With Nuts, Washers & "Push On" Speed Washers

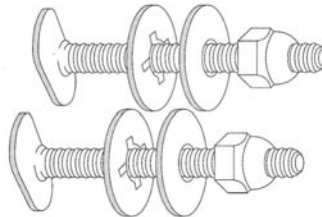

PART NUMBER	2 Brass Bolts 2 NP Brass Nuts 2 Plated Steel Washers 2 Plastic Speed Washers
102-SN	1/4" x 2-1/4"
107-SN	1/4" x 3-1/2"

Brass Bolts With Nuts, Washers, Speed Nuts & Round Plastic Bolt Caps

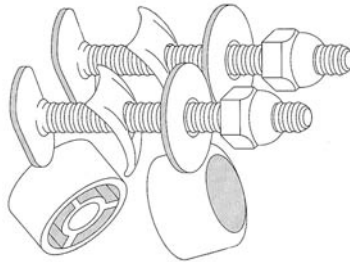

PART NUMBER	2 Brass Bolts 2 NP Brass Nuts 2 Plated Steel Washers 2 Steel Speed Nuts 2 Round Plastic Bolt Caps
106	1/4" x 2-1/4"

Break-Away Brass Bolts With Nuts, Washers & Brass retainer washer

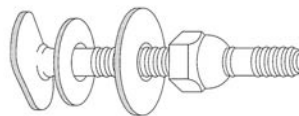

PART NUMBER	2 Brass Break-Away Bolts 2 NP Brass Nuts 2 Plated Steel Washers
100-BB	1/4" x 2-1/4"
82-BB	5/16" x 2-1/4"

Brass Bolts With Nuts, Washers & Hex Speed Nuts

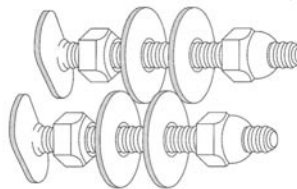

PART NUMBER	2 Brass Bolts 2 NP Brass Nuts 4 Plated Steel Washers 2 Plated Steel Hex Nuts
28	1/4" x 2-1/4"
30	1/4" x 3-1/2"

Brass bolts made in the U.S.A.

PASCO has cataloged the most popular bolt sets. Please contact us to package any set you require from other componets listed on the following pages.



PACKAGED *STEEL* CLOSET BOLT SETS

**Steel Bolts Standard
With Nuts & Washers**

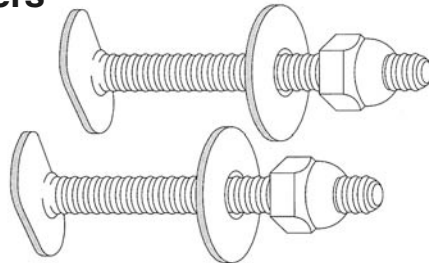

PART NUMBER	2 Plated Steel Bolts 2 Plated Steel Nuts 2 Plated Steel Washers
101	1/4" x 2-1/4"
95	1/4" x 3-1/2"
90	5/16" x 2-1/4"

**Steel Bolts With
Nuts, Washers &
Steel Speed Nuts**

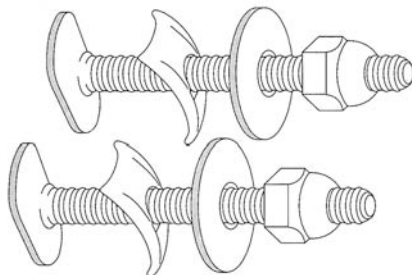

PART NUMBER	2 Plated Steel Bolts 2 Plated Steel Nuts 2 Plated Steel Washers 2 Steel Speed Nuts
105	1/4" x 2-1/4"
46	1/4" x 3-1/2"
90-TN	5/16" x 2-1/4"

**Steel Bolts With
Nuts, Washers, &
"Push On" Speed
Washers**

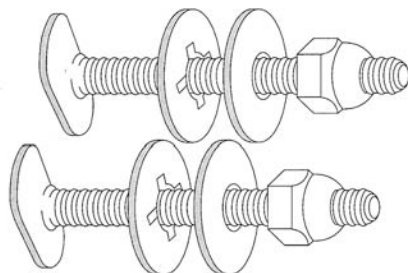

PART NUMBER	2 Plated Steel Bolts 2 Plated Steel Nuts 2 Plated Steel Washers 2 Plastic Speed Washers
105-SN	1/4" x 2-1/4"
46-SN	1/4" x 3-1/2"

**Steel Bolts
With Nuts,
Washers, Steel
Speed Nuts &
Round Plastic
Bolt Caps**

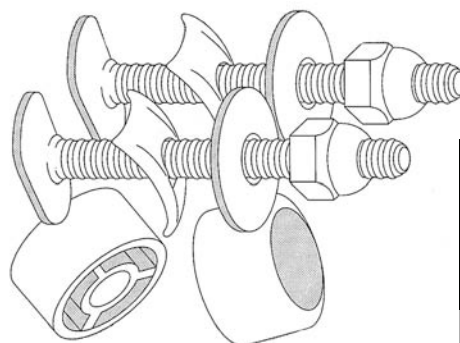

PART NUMBER	2 Plated Steel Bolts 2 Plated Steel Nuts 2 Plated Steel Washers 2 Steel Speed Nuts 2 Round Plastic Bolt Caps
119	1/4" x 2-1/4"

PASCO has cataloged the most popular bolt sets. Please contact us to package any set you require from other components listed on the following pages.



CLOSET BOLTS, SCREWS, NUTS & WASHERS
Bulk Packed in 100's

Closet Studs - Brass



PART NUMBER	SIZE
108	1/4" x 2-1/4"

Closet Bolts - Brass or Steel

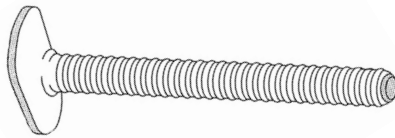

Brass Bolts are Made in U.S.A.

BRASS		PLATED STEEL	
PART NUMBER	SIZE	PART NUMBER	SIZE
110	1/4" x 2-1/4"	114	1/4" x 1-3/4"
111	1/4" x 3-1/2"	115	1/4" x 2-1/4"
112	5/16" x 2-1/4"	116	1/4" x 3-1/2"
113	5/16" x 3-1/2"	88	5/16" x 2-1/4"

Closet Screws - Brass or Steel

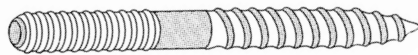

Brass Screws are Made in U.S.A.

BRASS		PLATED STEEL	
PART NUMBER	SIZE	PART NUMBER	SIZE
120	1/4" x 2-1/2"	125	1/4" x 2-1/2"
121	1/4" x 3-1/2"	126	1/4" x 3-1/2"
122	5/16" x 2-1/2"		
123	5/16" x 3-1/2"		

BreakAway Bolts - Brass

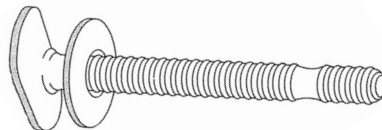

Brass Bolts are Made in U.S.A.

PART NUMBER	SIZE
110-BB	1/4" x 2-1/4"
112-BB	5/16" x 2-1/4"

Speed Nuts - Steel



PART NUMBER	SIZE
136	1/4"
143	5/16"

Open Head Bolt Nuts - Plated

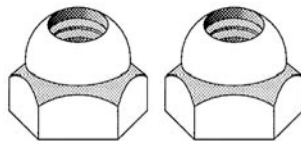

BRASS		PLATED STEEL	
PART NUMBER	SIZE	PART NUMBER	SIZE
132	1/4"	131	1/4"
133	5/16"	144	5/16"

Closed Head Screw Nuts - Plated

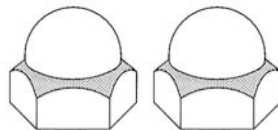

BRASS		PLATED STEEL	
PART NUMBER	SIZE	PART NUMBER	SIZE
134	1/4"	137	
135	5/16"	--	

Closet Bolt Washers

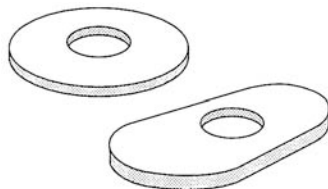

ROUND WASHER		OVAL WASHER	
PART NUMBER	MATERIAL	PART NUMBER	
138	Plated Steel	145	
--	Stainless Steel	146	
140	Heavy Stainless Steel	147	
142	Heavy NP Brass	149	

Plastic Bolt Caps

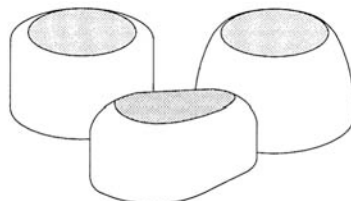

PART NUMBER	SIZE	SHAPE
912	1/4"	Oval
913	1/4"	Round
917-PR*	1/4" or 5/16"	Round

* With snap on washer



CLOSET BOLTS, SCREWS, NUTS & WASHERS
Bulk Packed in 100's

Combo Brass Closet Screws, Nuts & Washers

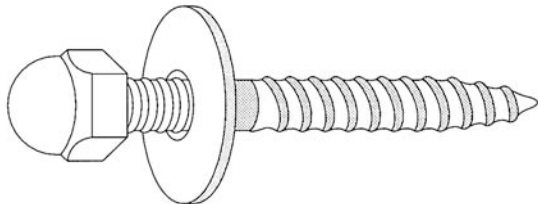

PART NUMBER	SIZE	ROUND WASHER
152	1/4" x 2-1/2"	Plated Steel
153	1/4" x 3-1/2"	Plated Steel
156	1/4" x 2-1/2"	Stainless Steel
157	1/4" x 3-1/2"	Stainless Steel
162	1/4" x 2-1/2"	Plated Brass
163	1/4" x 3-1/2"	
164	5/16" x 2-1/4"	
165	5/16" x 3-1/2"	

Combo Plated Steel Closet Screws, Nuts & Washers

PART NUMBER	SIZE	ROUND WASHER
168	1/4" x 2-1/2"	Plated Steel
169	1/4" x 3-1/2"	Plated Steel

Combo Brass Closet Bolts, Nuts & Washers

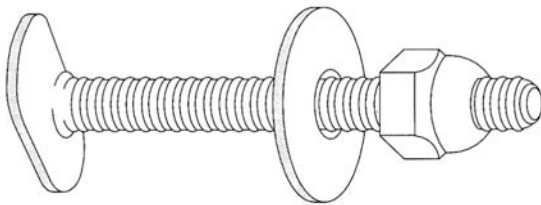

PART NUMBER	SIZE	ROUND WASHER
180	1/4" x 2-1/4"	Plated Steel
180-BB*		
181	1/4" x 3-1/2"	Stainless Steel
184	1/4" x 2-1/4"	
185	1/4" x 3-1/4"	Plated Brass
188	1/4" x 2-1/4"	
189	1/4" x 3-1/4"	Plated Steel
204-BB	5/16" x 2-1/4"	

*Breakoff Bolts

Combo Plated Steel Closet Bolts, Nuts & Washers

PART NUMBER	SIZE	ROUND WASHER
251	1/4" x 1-3/4"	Plated Steel
210	1/4" x 2-1/4"	
211	1/4" x 3-1/2"	
253	5/16" x 2-1/4"	

Combo Brass Closet Bolts, Nuts & Washers

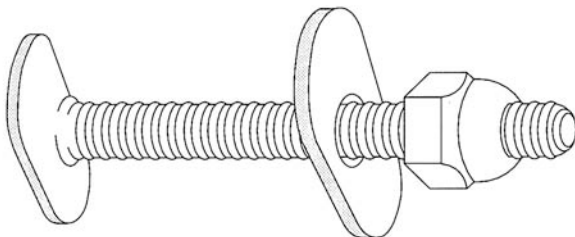

PART NUMBER	SIZE	OVAL WASHER
192	1/4" x 2-1/4"	Plated Steel
193	1/4" x 3-1/2"	
196	1/4" x 2-1/4"	Stainless Steel
197	5/16" x 3-1/2"	
202	1/4" x 2-1/4"	Plated Brass
203	1/4" x 3-1/2"	
204	5/16" x 2-1/4"	
205	5/16" x 3-1/2"	

Combo Plated Steel Closet Bolts, Nuts & Washers

PART NUMBER	SIZE	OVAL WASHER
222	1/4" x 2-1/4"	Plated Steel
226		Plated Brass



CLOSET BOWL WAX GASKET

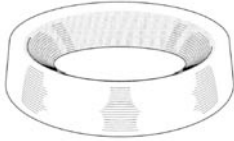

PART NUMBER	DESCRIPTION
268	Gasket
269	Gasket w/ #102 Brass bolt sets

Made in U.S.A.

CLOSET FLANGE EXTENSION

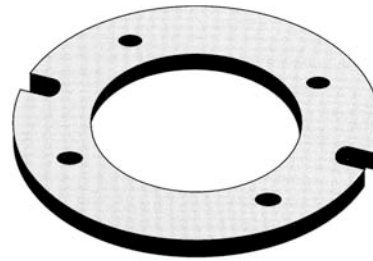

1/4" thick
Durable ABS
Made in U.S.A.

PART NUMBER
1018

FLEX - A - FLANGE

Closet Bowl Wax Gasket With Plastic Flange

For 3" or 4" cast iron, brass, plastic and steel/plastic combo closet rings.

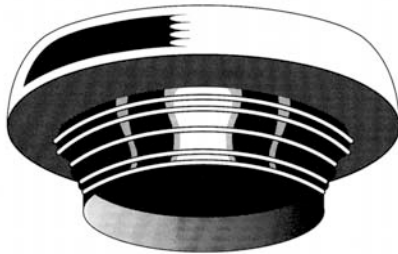

PART NUMBER	DESCRIPTION
270	Flange
271	Flange w/ #102 brass bolt sets

Made in U.S.A.

CLOSET FLANGE EXTENSION KIT

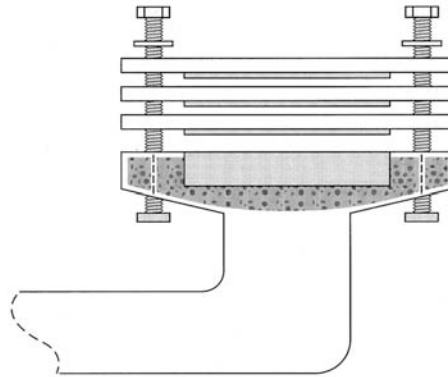

Kit Contains:

3 Self-sealing extenders
With 1/4" X 3-1/2" closet bolts, nuts & washers

Made in U.S.A.

PART NUMBER	BOLT SET
1018-K	Steel
1018-BR	Brass

SPONGE RUBBER CLOSET BOWL GASKET



Resists mold, mildew and fungus
Made in U.S.A.

PART NUMBER	THICKNESS & DIAMETER
2228	9/16" x 5-1/4"
2230	3/4" x 5-1/4"

SPONGE RUBBER CLOSET BOWL GASKET
Covers Entire Width of Closet Ring



Resists mold, mildew and fungus
Has holes for closet bolts
Made in U.S.A.

PART NUMBER	THICKNESS & DIAMETER
2227	3/8" X 6-3/4"
2231	3/4" x 6-3/4"



BRASS TANK TO BOWL BOLT SETS

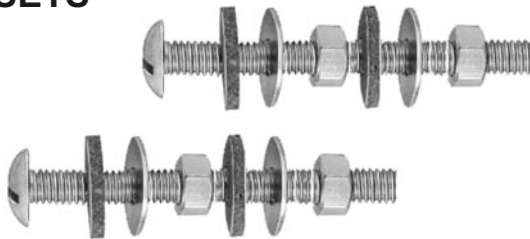

EACH SET CONTAINS:

- Brass Bolts
- Brass Hex Nuts
- Cloth Inserted Rubber Washers
- Plated Brass Washers
- Made in U.S.A.

PART NUMBER	SIZE	WASHERS	
		RUBBER	PLATED BRASS
235	5/16" x 3"	2	2
237		4	4

TANK TO BOWL CONNECTOR KIT With Rubber Gasket



Made in U.S.A.

EACH SET CONTAINS:

- 1 Rubber gasket
- 2 Bolts - Brass or steel
- 4 Heavy washers - Brass or Steel
- 4 Rubber washers
- 4 Hex nuts - Brass or Steel

KIT PART NO. WITH BRASS BOLTS	GASKET TYPE	KIT PART NO. WITH STEEL BOLTS
437	Regular	438
439	Amstan	440
441	Crane	442
443	Gerber	444

TOILET STABILIZER SHIMS

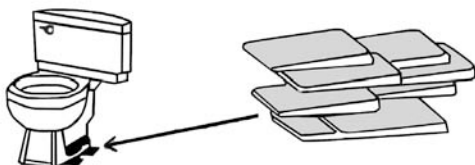

Plastic
10 Per bag

PART NUMBER
234

STEEL TANK TO BOWL BOLT SETS



EACH SET CONTAINS:

- Plated Steel Bolts
- Steel Hex Nuts
- Cloth Inserted Rubber Washers
- Steel Washers

PART NUMBER	SIZE	WASHERS	
		RUBBER	STEEL
239	5/16" x 3"	2	2
241		4	4

CLOTH INSERTED Rubber Washers

FOR TANK TO BOWL BOLT

Made in U.S.A.



PART NUMBER
242

HEX NUT For Tank to Bowl Bolt



PART NUMBER	MATERIAL	SIZE
243-B	Brass	5/16"
243	Steel	

TANK TO BOWL BOLTS



PART NUMBER	MATERIAL	SIZE
232	Brass*	5/16" x 3"
233	Steel	

*Made in U.S.A.



**PASCO'S
all new
items**

PASCO'S PLUMBERS AIR PUMP



We drove our truck over this pump and it
STILL WORKS!

- Made of virtually unbreakable polyethylene
- 1-1/4" one piece barrel permits a large volume of air
- 48" Non-kinking hose
- Quick connect thumb valve
- Large easy grip handle
- 2" 0-150PSI gauge
- Easy to read RED pressure range arrow.

**PART
NUMBER
1424**



TOILET TANK TRIP LEVERS

PREMIUM QUALITY

8" Flat brass arm
 CP Die cast handle
 Die Cast lock nut

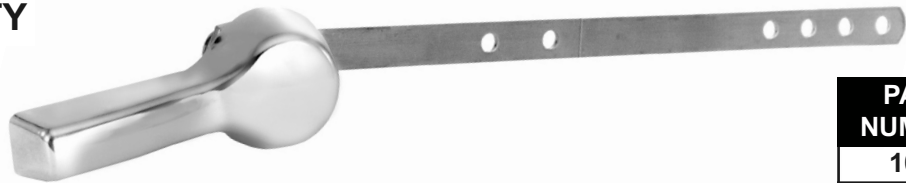

PART NUMBER
1055

ECONOMY

8" ABS Plastic arm
 CP ABS Plastic handle



PART NUMBER
1047

ECONOMY

8" Round brass arm
 CP Die cast handle
 Die cast spud
NEW finger tight locknut



PART NUMBER
1040
1040-PB

PB = POLISHED BRASS HANDLE

ECONOMY

8" Round brass arm
 CP Die cast handle
 Plastic spud
NEW finger tight locknut



PART NUMBER
1041

ECONOMY

4" ABS Plastic arm
 CP ABS handle
 Replaces American Standard
 #3521-136



PART NUMBER
1046

FITS ALL

8" Brass arm
 CP ABS Plastic handle
 Fits almost any toilet tank lever
 Snap with pliers at appropriate
 score marks
 Connects to any flapper



PART NUMBER
1044



TOILET TANK TRIP LEVERS

INDEX STYLE

8" Round brass arm
 CP Die cast handle
 Plastic spud
 Plastic lock nut



PART NUMBER
1057

MANSFIELD

9" White plastic arm
 CP Die cast handle
 Plastic spud
 Plastic lock nut



PART NUMBER
1045

WESTERN POTTERY & TOTO

10" Round brass arm
 CP Die cast handle
 Plastic spud
 Plastic locknut
 Side mount



1058 Western Pottery

1059 Toto

PART NUMBER
1058
1059

KOHLER WELLWORTH II

8" Plastic arm
 CP Die cast handle
 Plastic spud
 Plastic locknut



PART NUMBER
1053

ELJER

10" Brass arm
 CP Die cast handle
 Plastic spud
 Plastic locknut
 Side mount



PART NUMBER
1054

OFFSET - PREMIUM QUALITY

9-1/2" Offset flat brass arm
 CP Die cast handle
 Modern styling
 High Quality
 Die cast locknut



PART NUMBER
1056



korky[®]

Universal replacement flapper
Preferred by plumbers for superior quality and reliability since 1954.



**PART
NUMBER**
54

korky plus[®]

Premium quality Chlorazone material withstands
chloramine and toilet tank cleaners
5-Year guarantee
Universal replacement flapper



**PART
NUMBER**
2001

korky 1.6[®]

Fits most 1.6 gallon toilets
The adjustable water-saver
saves up to 50% more water
when used in conventional toilets.



**PART
NUMBER**
16

korky classic[®]

For older, 5 and 7 g.p.f. toilets
Original design for brass flush valves



**PART
NUMBER**
50

korky[®] **MAX FLUSH**

Stays open longer for maximum flush
Specially designed for low boy
style toilets
Fits slanted plastic flush valves



**PART
NUMBER**
92

KOHLER

With styrofoam float
This flapper includes the styrofoam float
and is adjustable for the perfect flush.



**PART
NUMBER**
2004



RUBBER FLAPPER
Stainless Steel Chain



High quality rubber
Resistant in tank bowl cleaners

PART NUMBER
1026

3 WAY FLAPPER
Plastic Chain



DISCONTINUED
Substitute 1028-S

High quality vinyl

PART NUMBER
1028

RUBBER FLAPPER
8" Chain



For Kohler
Resistant to tank bowl cleaners

PART NUMBER
1031

TANK BALL



Resists chlorinated water
Never swells
One ball for all sizes
High quality rubber

PART NUMBER
1032

3 WAY FLAPPER
Stainless Steel Chain



High quality vinyl

PART NUMBER
1028-S

PLASTIC FLUSH VALVE FLAPPER
Stainless Steel Chain



High quality vinyl

PART NUMBER
1033

AMERICAN STANDARD FLAPPER
With Float

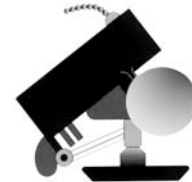

PART NUMBER	REPLACES AMSTAN #	DESCRIPTION
1038	#5	Low profile
1039	#6	High profile
1042	Repair kit with chain rubber grommet & clip	

DISK SEAT FLAPPER
For American Standard



PART NUMBER	DESCRIPTION
1035	Combo Fit-All
1036	Screw-On
1037	Snap-On



DOUGLAS FLUSH VALVE

Rubber washer
Solid ring guide
Locknut
Overflow tube



PART NUMBER	DESCRIPTION
1025	Die cast locknut
1027	Brass locknut
1029	White plastic flush valve, with flapper

BRASS OVERFLOW TUBES



Made in U.S.A.

PART NUMBER	DIAMETER	LENGTH
870	1"	10"
873	1" X 1-1/8"	10"

BRASS FLUSH VALVE GUIDES



1" Adjustable
Heavy pattern

PART NUMBER
1023



1" Adjustable
Heavy pattern deluxe

PART NUMBER
1024

TANK FLOATS

Copper or Plastic



Made in U.S.A.

PART NUMBER	SIZE	TYPE	FLOAT ROD
1060-12	4" X 5"	Oval Copper	1/4"
1067	3"	Round Copper	
1068	4"		
1069	5"		
1070	6"		
1072	8"		3/8"
1073	4" X 5"	Oval Plastic	1/4"

LIFT WIRES - BRASS



Order in packs
of 25 or 100

Made in U.S.A.

PART NUMBER	DESCRIPTION
850	4-1/2" Lower lift wire
851	5-1/2" Lower lift wire
856	9" Upper Lift wire

BRASS FLOAT RODS
1/4" - 20 Threads



Made in U.S.A.

PART NUMBER	LENGTH
882	8"
883	9"
884	10"
886	12"

BRASS SEAT HINGES



PART NUMBER	DESCRIPTION
1215	Polished Brass
1218	CP Brass



BRASS URINAL OUTLET SPUD
IPS or Sweat Connection

With studs, washers and nuts and # 2096 sponge type gasket



PART NUMBER	DRAIN CONNECTION	URINAL TYPE	BOLT HOLE CENTERS
94700	2" IPS	Crane	5-1/2"
94701	2" Sweat	Crane	5-1/2"
94702	2" IPS	Crane Hex Bolts	5-1/2"
94703	2" IPS	UR	4-1/2"
94704	2" IPS	Eljer	4-1/4"
94705	2" Sweat	Eljer	4-1/4"
94706	2" IPS	Amstan	4"

CLOSET & URINAL SPUDS



PART NUMBER	TYPE	SIZE	LOCKNUT
956	Closet	2"	Brass
956A	Closet		Die Cast
957	Closet	2" X 1-1/2"	Brass
958	Closet	2" X 1-1/4"	Brass
959	Closet	1-1/2"	Brass
959A	Closet		Die Cast
960	Closet	1-1/4"	Brass
961	Urinal	1" X 3/4"	Brass
962	Urinal	1-1/4"x3/4"	Brass
963	Closet	1-1/2"x1-1/4"	Brass

ANTI - SIPHON BALLCOCKS



Reliable - Quiet
 Brass float rod
 Adjustment screw

PART NUMBER	DESCRIPTION
1009	8-1/2"
1010	10"
1011	12"
1014	Ballcock repair kit includes valve seat plunger, with O-ring diaphragm brass screw bonnet with arm
1015-N	Diaphragm & adjustable screw
1320	Plastic coupling nut
2099	Shank washer



LOCK NUTS



PART NUMBER	SIZE	MATERIAL
1294	1/2"	Die Cast
1295	3/4"	Die Cast
1296	15/16"	Die Cast Ballcock
1298	1"	Die Cast
1300	1-1/4"	Die Cast
1301	1-1/2"	Die Cast
1303	2"	Die Cast
1306	1-1/4"	Brass
1307	1-1/2"	Brass
1309	2"	Brass
1312	3-3/8"	Brass Basket Strainer
1316	3-3/8"	Die Cast Basket Strainer

LAVATORY COUPLING NUTS

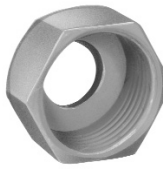

PART NUMBER	SIZE	MATERIAL
1322	1/2" X 7/16"	Brass
1322-C		CP Brass
1326-C	1/2" X 3/8"	CP Die Cast
1327-C	1/2" X 7/16"	CP Die Cast
1327-P		Die Cast
1328-C	1/2" X 1/2"	CP Die Cast
1328-P		Die Cast
1329-C	3/4" X 1/2"	CP Die Cast Bathcock
1329-P		Die Cast Bathcock
1335	1/2" X 1/2"	Brass
1335-C		CP Brass

BALLCOCK COUPLING NUT

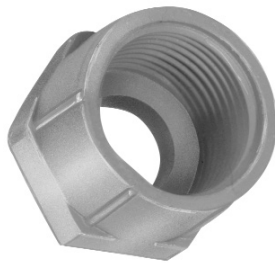

PART NUMBER	MATERIAL
1320	Plastic
1321	Brass

BRASS SOLDER COLLARS



Threads fit slip joint nuts

PART NUMBER	SLIP JOINT	FOR USE WITH
1314	1-1/2"	Tubular
1315		CWT

PASCO
SMART PLUMBING
STARTS HERE



DIE CAST SLIP JOINT NUTS



PART NUMBER	SIZE	FINISH
1324-C	2" x 1-1/2"	Chrome
1330-C	1-1/4"	Chrome
1331-C	1-1/2" x 1-1/4"	Chrome
1331-P		Plain
1332-C	1-1/2" x 1-3/8"	Chrome
1333-C	1-1/2"	Chrome
1333-P		Plain
1334-C	2"	Chrome

BRASS SLIP JOINT NUTS



PART NUMBER	SIZE	FINISH
1336	1-1/4"	Rough
1336-C		Chrome
1337	1-1/2" x 1-1/4"	Rough
1337-C		Chrome
1338	1-1/2"	Rough
1338-C		Chrome
1339	2"	Rough
1339-C		Chrome

CHROME SLIP JOINT NUT SETS WITH WASHER, FRICTION RING

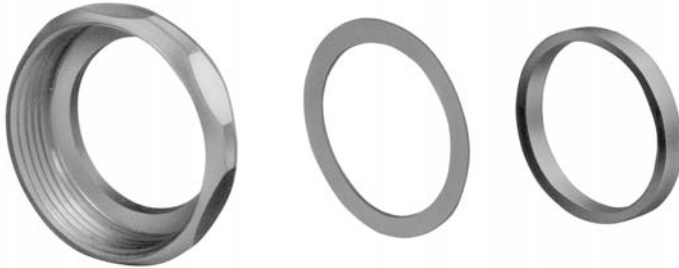

PART NUMBER	SIZE	MATERIAL
1346-C	1-1/4"	Brass
1347-C	1-1/2" x 1-1/4"	Brass
1348-C	1-1/2"	Brass
1349-C	1-1/4"	Die Cast
1350-C	1-1/2" x 1-1/4"	Die Cast
1351-C	1-1/2"	Die Cast

**PLASTIC SLIP JOINT NUTS - PVC
REGULAR OR TWO PIECE**

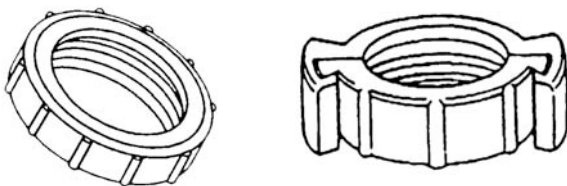

PART NUMBER	SIZE	STYLE
1352	1-1/4"	One Piece
1353	1-1/2"	Piece
1354	1-1/4"	Two
1355	1-1/2"	Piece

BRASS FRICTION RINGS



PART NUMBER	SIZE
1385	1/2" x 3/8"
1387	3/4" x 7/16"
1388	1/2" x 7/16"
1389	1/2" x 1/2"
1390	3/4" x 1/2"
1391	1-1/4"
1392	1-1/2" x 1-1/4"
1394	1-1/2"
1397	3/4" x 3/8"



TANK-TO-BOWL GASKETS

Sponge Rubber



Made in U.S.A.

PART NUMBER	DESCRIPTION
2095	Crane
2096	Regular
2097	Recessed for American Standard
2098	Gerber

SLIP JOINT WASHERS

Square Cut Washers

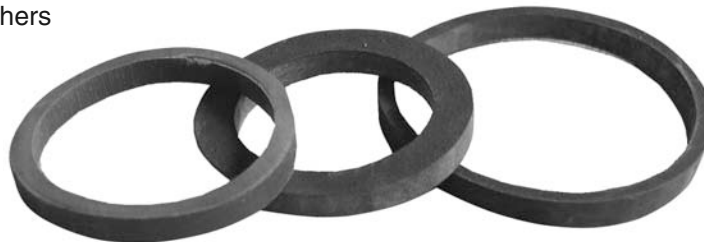

Made in U.S.A.

PART NUMBER	SIZE
2201	2" x 1-1/2"
2202	2"
2204	1-1/2"
2208	1-1/2" x 1-1/4"
2209	1-1/4"

POLY WASHERS FOR TAILPIECES



Made in U.S.A.

PART NUMBER	SIZE	DESCRIPTION
2214	1-1/2"	Beveled
2218	1-1/2" x 1-1/4"	
2219	1-1/4"	
2222	1-1/2"	Flanged

TAILPIECE WASHER

Cloth Inserted Rubber

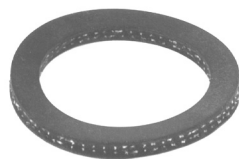

Top quality,
excellent seal
Made in U.S.A.

PART NUMBER	SIZE
2211	1-1/2" x 1-1/4"

BALLCOCK SHANK WASHER

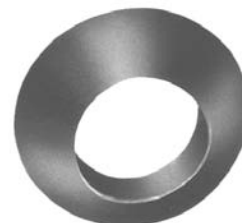

Beveled rubber

PART NUMBER
2099

GARDEN HOSE WASHER

Fits 3/4" FHT

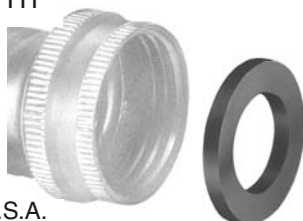

Made in U.S.A.

PART NUMBER
2224

CONE FILTER WASHER

Fits 3/4" FHT

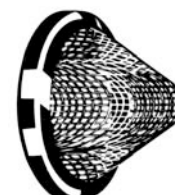

PART NUMBER
2244



SPUD FRICTION RINGS
Galvanized



PART NUMBER	SIZE
2075	2"
2076	2" x 1-1/2"
2077	2" x 1-1/4"
2078	1-1/2"
2079	1-1/4"
2080	1" x 3/4"

Made in U.S.A.

1-1/4" MACK WASHER
For Pop-Ups

Rubber

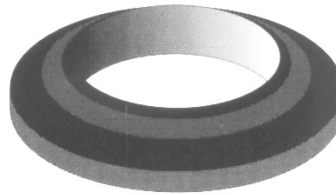

PART NUMBER
2074

Made in U.S.A.

WALL HUNG URINAL SPUD WASHER

Large style for additional sealing surface
4-3/8" OD x 2-7/8" ID
1/2" Thick
Sponge rubber



PART NUMBER
2083

Made in U.S.A.

SPUD WASHERS

Rubber



PART NUMBER	SIZE
2085	2"
2086	2" x 1-1/2"
2087	2" x 1-1/4"
2088	1-1/2"
2089	1-1/4"
2090	1" x 3/4"

Made in U.S.A.

WASTE & OVERFLOW WASHERS

Sponge Rubber



PART NUMBER	DESCRIPTION
2091	2-1/8" X 3-7/16" x Beveled
2092	1-7/8" x 2-7/8" x 3/8"

DOUGLAS FLUSH VALVE WASHER

Sponge Rubber
Fits urinal outlet spuds



PART NUMBER
2093

Made in U.S.A.



GARBAGE DISPOSER SHIELD



PART NUMBER
1358

PLUMBERS PACK O-RING KIT
Popular O-ring sizes in a reusable box



PART NUMBER
2250

Made in U.S.A.

O-RING PICK



PART NUMBER
5200

CONE SLIP JOINT WASHERS



2276 2277 2277-A 2285 2286 2287

PART NUMBER	SIZE		USAGE
	I.D.	HT.	
2276	3/8"	3/8"	1/2" Nut 3/8" Tube
2276-T			1/2" Nut Thread 3/8" Tube
2277			1/2" Nut 3/8" Tube
2277-A	7/16"	7/16"	1/2" Nut 7/16" or 1/2" tube
2285	11/32"	11/32"	3/8" Tube Ballcock
2286	3/8" Supply X Lav - Sq. Cut		
2287	3/8" Supply X Ballcock - Sq. Cut		

CANDLE WICKING & GRAPHITE PACKING



Seals bonnet nuts
Lubricates stems
Random length

PART NUMBER
2872

GRAPHITE PACKING

1/16" x 24" Length

PART NUMBER
2290

FAUCET STEM WASHER ASSORTMENT - FLAT

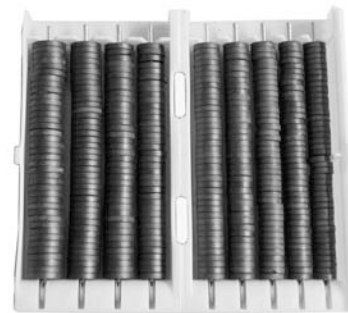

00-1/2" Trade Size
350 Pieces
Eight common sizes
fit most stems
manufactured

PART NUMBER
2870

Made in U.S.A.

SOAP DISPENSER

THROUGH THE COUNTER



2" Spout
10" Length
Chrome plated brass pump
Mounts through counter
Unbreakable poly bottle
Holds 7 oz.

PART NUMBER	DESCRIPTION
2042	Complete dispenser
2042-B	Bottle Only
2042-F	Chrome Flange
2042-N	Brass Nipple With Nut & Friction Ring Washer
2042-P	Chrome Pump & Plastic stem



COMMERCIAL LAV DRAIN
WITH TAIL PIECE
Highest Quality



Chrome plated brass
1-1/4"x 6" tailpiece
17 Gauge tube
Brass locknut
Rubber gasket
with overflow

PART NUMBER
1176

HANDICAP STYLE LAV DRAIN
Highest Quality



Chrome plated brass
1-1/4"x 9" waste elbow
17 Gauge tube
Brass locknut
Rubber gasket
with overflow

PART NUMBER
1177-TP

HANDICAP STYLE LAV DRAIN
LESS WASTE ELBOW
Highest Quality



Chrome plated brass
Threaded 1-1/4" for
waste elbow
Brass locknut
Rubber gasket

PART NUMBER
1177

REPLACEMENT STRAINERS
Snap - in stainless steel



PART NUMBER	STRAINER SIZE	FITS
1205	3"	2" DWV
1206	4"	3" DWV
1207	5"	4" DWV

CRUMB CUP STRAINER



Chrome plated brass
1341 - 1-7/8" x 1"
1344 - 1-1/4" x 11/16"

PART NUMBER	FITS
1341	Sink
1344	Lavatory less post

BRASS POP-UP ASSEMBLIES



Chrome plated brass
Brass locknut
Highest quality

*plastic

PART NUMBER	TYPE
11701	Moen*
11702	Price Pfister
11703	Gerber



BRASS WASTE CONNECTORS (DESANKO FITTINGS)

The charts below let you choose the type of slip joint nut, either chrome plated die cast or plain brass and the type of compression ring, either brass or poly. To order waste connectors with chrome plated brass nuts, add **CP** to waste connector part number.

**TUBULAR X MALE PIPE
THREAD (OUTLET)
FEMALE COPPER SWEAT
UNDER MPT**



PART NUMBER	TUBULAR X MPT	SLIP NUT	COMPRESSION RING
1892	1-1/4"	Chrome Die Cast	Brass
1893	1-1/4" x 1-1/2"		
1894	1-1/2"		
1942	1-1/4"	Rough Brass	
1943	1-1/4" x 1-1/2"		
1944	1-1/2"		
1904	1-1/4"	Chrome Die Cast	Poly
1905	1-1/4" x 1-1/2"		
1906	1-1/2"		
1944-S with stops*	1-1/2"	Rough Brass	Brass

*Complies with UPC

**TUBULAR X FEMALE PIPE
THREAD (OUTLET)**



PART NUMBER	TUBULAR X FPT	SLIP NUT	COMPRESSION RING
1895	1-1/4"	Chrome Die Cast	Brass
1896	1-1/4" x 1-1/2"		
1897	1-1/2"		
1945	1-1/4"	Rough Brass	
1946	1-1/4" x 1-1/2"		
1947	1-1/2"		
1907	1-1/4"	Chrome Die Cast	Poly
1908	1-1/4" x 1-1/2"		
1909	1-1/2"		
1947-S With Stops*	1-1/2"	Rough Brass	Brass

*Complies with UPC

FEMALE COPPER SWEAT (OUTLET)



PART NUMBER	TUBULAR X COPPER	SLIP NUT	COMPRESSION RING
1898	1-1/4"	Chrome Die Cast	Brass
1899	1-1/4" x 1-1/2"		
1900	1-1/2"		
1948	1-1/4"	Rough Brass	
1949	1-1/4" x 1-1/2"		
1950	1-1/2"		
1910	1-1/4"	Chrome Die Cast	Poly
1911	1-1/4" x 1-1/2"		
1912	1-1/2"		

Continued on following page



BRASS WASTE CONNECTORS (DESANKO FITTINGS)

The charts below let you choose the type of slip joint nut, either chrome plated die cast or plain brass and the type of compression ring, either brass or poly. To order waste connectors with chrome plated brass nuts, add **CP** to waste connector part number.

MALE COPPER SWEAT (OUTLET)



PART NUMBER	TUBULAR X COPPER	SLIP NUT	COMPRESSION RING
1901	1-1/4"	Chrome Die Cast	Brass
1902	1-1/4" x 1-1/2"		
1903	1-1/2"		
1951	1-1/4"	Rough Brass	
1952	1-1/4" x 1-1/2"		
1953	1-1/2"		
1913	1-1/4"	Poly	Poly
1915	1-1/2"		

WASTE ARM COVER TUBE

6" x 22 Gauge chrome plated brass tubing
Covers 1-1/2" or 2" IPS galvanized or brass waste arm nipples
Also available to cover 1-1/2" copper

DISCONTINUED

PART NUMBER	FITS
17995	1-1/2" IPS
17996	2" IPS
17997	1-1/2" CWT

CHROME PLATED COPPER SUPPLY TUBING



"Spaghetti"
3/8" x 6 Foot - soft
50 Per case

PART NUMBER
17990

COMPRESSION RINGS ONLY



PART NUMBER		
BRASS	POLY	SIZE
1990	2219	1-1/4"
1992	2214	1-1/2"



AERATORS

Quality recognized for years throughout the industry!

PREMIUM QUALITY

Chrome plated brass
 Special stainless steel screen
 Stylized appearance
 NSF listed Santoprene® washer
 All aerators are individually bagged
 Meets ANSI A-112.18M
 2.2 GPM at 60 PSI
 2.5 GPM at 80 PSI



Made in U.S.A.

SLOTTED

PART NUMBER	THREADS
2100	Male 15/16"-27
2103	Female 55/64"-27
2105	Dual 15/16"-55/64"-27

NON-SLOTTED

PART NUMBER	FINISH	THREADS
2105AB	Ant. Brass	Dual 15/16"-55/64"-27
2105PB	Polish. Brass	55/64"-27

SLOTTED WATER SAVER

PART NUMBER	THREADS
2104	Dual 15/16" - 55/64" - 27

ECONOMY QUALITY

Chrome plated brass
 Stylized appearance
 NSF listed Santoprene® washer*
 All aerators are individually bagged
 Meets ANSI A-112.18M
 2.2 GPM at 60 PSI
 2.5 GPM at 80 PSI



Made in U.S.A.

NON-SLOTTED

PART NUMBER	THREADS
2120	Male 15/16" - 27
2122	Female 55/64" - 27
2124	Dual 15/16"-55/64"-27
2130	Male 13/16" - 27
2131	Female 3/4" - 27

NON-SLOTTED WATER SAVER

PART NUMBER	THREADS
2132	Male 15/16" - 27
2133	Female 55/64" - 27
2134	Dual 15/16"-55/64"-27

SWIVEL SPRAY

Chrome plated brass
 Special stainless steel screen
 Superior quality
 NSF listed Santoprene® washer*



Made in U.S.A.

Santoprene® is a registered trademark of The Monsanto Company.

PART NUMBER	THREADS
2114	Dual 15/16" - 55/64" - 27



AERATOR COUNTER DISPLAYS

**24
Tubes
6 Aerators
per tube**



Slotted premium quality

PART NUMBER	DUAL THREADS
2106	Contains 144-2105
2107	Contains 144-2104 Water Saver

Non-slotted economy quality

PART NUMBER	THREADS
2125	Contains 144-2124
2136	Contains 144-2134 Water Saver

Made in U.S.A.

These displays are guaranteed to trigger an impulse purchase by the plumber!

*Small display generates **BIG** profits!*

KITCHEN SINK HOSE AND SPRAY HEAD

Replaces existing units



PART NUMBER	DUAL THREADS
1366	COMPLETE UNIT
1367	HOSE, COUPLING
1367-W	WHITE COMPLETE UNIT
1368	HEAD ONLY
1368-W	WHITE-HEAD ONLY
1369	HOSE GUIDE

FIT ALL KITCHEN BASKET STRAINER- STAINLESS STEEL

Fits most styles of kitchen basket strainers



CP brass lift post
Rubber stopper

PART NUMBER
21926



JUNIOR BASKET STRAINER

For 2" - 2-1/2" Outlets

Stainless steel body and basket
Complete with washers and nuts



PART NUMBER	LOCKNUT	SLIP JOINT NUT
1361	Die Cast	Plated Die Cast
1361-BN	Brass	Brass
1361-B	BASKET ONLY	

JUNIOR DUO STRAINER

For 2" - 2-1/2" Outlets

Stainless steel body and basket
Complete with washers and nuts



PART NUMBER	LOCKNUT	SLIP JOINT NUT
1365	Die Cast	Plated Die Cast
1365-BN	Brass	Brass
1365-B	BASKET ONLY	

TRAY PLUG

For 2" - 2-1/2" Outlets

Stainless steel body
Complete with washers and nuts



PART NUMBER	LOCKNUT	SLIP JOINT NUT
1370	Die Cast	Plated Die Cast
1370-BN	Brass	Brass

FLAT DUPLEX STRAINER

For 2" - 2-1/2" Outlet

Stainless steel body and strainer
Complete with washers and nuts



PART NUMBER	LOCKNUT	SLIP JOINT NUT
1371	Die Cast	Plated Die Cast
1371-BN	Brass	Brass



Specification Grade Stainless Steel Basket Strainer - 2 Styles

Heavy duty - cup style
 3-1/2" to 4" Sink drain opening
 304 Stainless steel bodies
 Stainless steel basket
 Die cast locknut and slip joint nut
 Poly tailpiece washer
 # 21915 Specification basket strainer
 has brass locknut and slip joint nut

Equal to:
 Watts 644003
 Dearborn 14
 *Watts 652003



PART NUMBER	DESCRIPTION
21914	Complete Unit
21922	Basket Only
21915*	Ball lock stick post Complete Unit
21924	Basket Only

*21915 has 1-3/4" tail piece

Heavy Duty Commercial Grade Chrome Plated Brass Basket Strainer

Highest quality
 3-1/2" to 4" Sink drain openings
 Cast brass body
 Stainless steel basket
 Cast brass slide post and stopper
 Brass slip joint nut and locknut
 Poly tailpiece washer

Equal to:
 Dearborn 16
 Kohler K-8801
 Amstan 4331.013
 McGurire 151



DISCONTINUED
 Substitute 21907

PART NUMBER	DESCRIPTION
21916	Complete Unit
21925	Basket Only

Spin Lock Chrome Plated Brass Basket Strainer

3-1/2" to 4" sink drain openings
 Stainless steel screw in basket
 Brass locknut and slip joint nut
 Poly tailpiece washer

Equal to:
 Dearborn 17
 Watts 653003



PART NUMBER	DESCRIPTION
21917	Complete Unit
21923	Basket Only



Quick Tite Stainless Steel Basket Strainer



DISCONTINUED
Substitute 21901

3-1/2" to 4" sink drain opening
Triangular threaded flange with three thumb screws
Stainless steel stick post basket
Die cast slip joint nut
Poly tailpiece washer

Equal to:
Dearborn 3 BN
Watts 646443

PART NUMBER	DESCRIPTION
21903	Complete Unit
21921	Basket Only

Plumber Quality Chrome Plated Brass Basket Strainer



3-1/2" to 4" sink drain openings
Stainless steel stick post basket
Die cast slip joint nut and locknut
Poly tailpiece washer

Equal to:
Dearborn 16
Watts 2-8-3
Sanitary Dash SS250
Garvin 2250

PART NUMBER	DESCRIPTION
21906	Complete Unit
21921	Basket Only

Economy Stainless Steel Basket Strainer



3-1/2" to 4" sink drain openings
Stainless steel stick post basket
Die cast slip joint nut and locknut
Poly tailpiece washer

Equal to:
Dearborn 10
Watts 2-9-3
Sanitary Dash P100

PART NUMBER	DESCRIPTION
21910	Complete Unit
21921	Basket Only



LAVATORY LEGS

Adjustable To Fit a Variety of China and Enamel Lavatories

Chrome plated
2" Adjustment
30" overall length
Boxed by the pair
Installation instructions with each pair

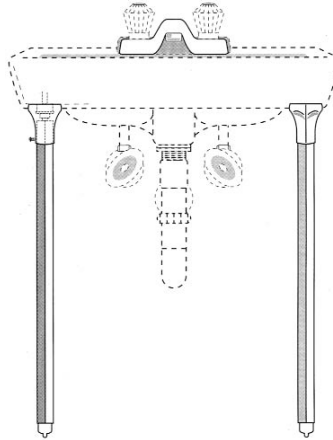

PART NUMBER
1250

DEEP BASIN ROSETTE

Stamped steel



PART NUMBER
1266

FLAP BASIN ROSETTE

Stamped steel



PART NUMBER
1268

FAUCET HOLE COVERS



PART NUMBER	SIZE
1274	2"
1275	1-3/4"

SNAP-IN FAUCET HOLE COVER

Chrome plated
Fits 1-1/2" hole

Holes in china or stainless steel fixtures vary in diameter. This cover fits most but not all manufacturers
Made in U.S.A.



PART NUMBER
1279



Brass Tubular



Since 1936 PASCO has manufactured and distributed high quality plumbing specialty items. In keeping with that tradition, we are now offering a complete line of brass tubular products to the plumbing trade.

PASCO's new line of brass tubular products is manufactured to the specific requirements of the professional plumber. Our chrome plated brass tubular products are triple plated with the application of copper, nickel and chrome. We take a further step to highly buff the surface, which provides a superior shine.

Finally, in accordance with plumbing codes throughout the United States, PASCO will only offer 20 or 17 gauge brass tubular products. All of our 17 gauge tubular which require nuts will only be offered with brass nuts. We won't however, be offering 22 gauge or "budget" grade tubular or will we offer a "satin" or budget chrome finish.

Professional plumbers demand that the items they install be of professional quality. PASCO has committed itself to provide that quality in this line of brass tubular products.

Brass Tubular

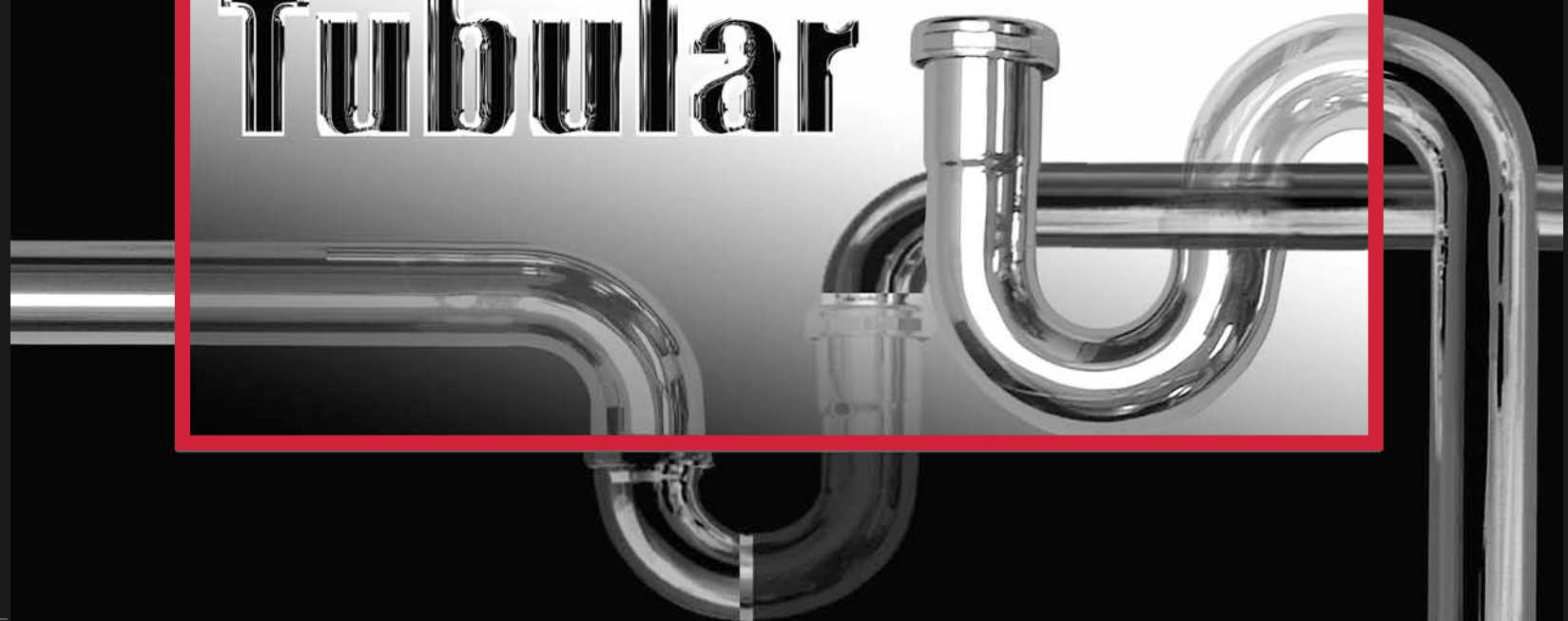



P Traps

All 17 gauge P Traps have CP brass nuts.
All 20 gauge P Traps have CP die cast nuts.



LESS CLEANOUT - 8" WALL BEND - CHROME

Beaded with slip joint washers or ground joint

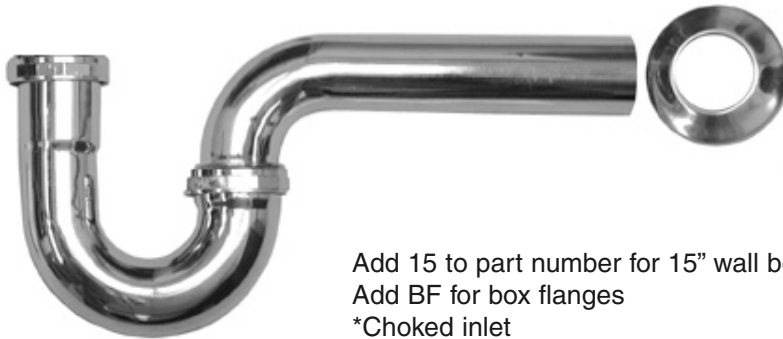

Add 15 to part number for 15" wall bend
Add BF for box flanges
*Choked inlet

30 Pieces per case

PART NUMBER	SIZE	GAUGE
34100	1-1/4"	20
*34102	1-1/2"X1-1/4"	
34104	1-1/2"	
34106	1-1/4"	17
*34108	1-1/2"X1-1/4"	
34110	1-1/2"	

Rough Brass

34105	1-1/2"	20
34107	1-1/2"	17

Ground Joint - Chrome

34109	1-1/2" x 1-1/4"	17
34111	1-1/2"	

WITH CLEANOUT - 8" WALL BEND - CHROME

Beaded with slip joint washers or ground joint



Add 15 to part number for 15" wall bend
Add BF for box flanges
*Choked inlet

30 Pieces per case

PART NUMBER	SIZE	GAUGE
34116	1-1/4"	20
*34118	1-1/2"X1-1/4"	
34120	1-1/2"	
34122	1-1/4"	17
*34124	1-1/2"X1-1/4"	
34126	1-1/2"	

Ground Joint

*34127	1-1/2" x 1-1/4"	17
34129	1-1/2"	

WALL BEND FOR P TRAP - CHROME



PART NUMBER	SIZE	GAUGE	CASE QTY
34128	1-1/4" X 8"	20	60
34130	1-1/2" X 9"		50
34132	1-1/2" X 15"		40
34134	1-1/4" X 8"	17	60
34136	1-1/2" X 9"		50
34138	1-1/2" X 15"		40



BRASS TUBULAR



Sink Traps

All 17 gauge Sink Traps have CP Brass nuts.
All 20 gauge Sink Traps have CP Die Cast nuts.

SINK TRAPS WITH CAST BRASS OUTLET ELBOW - CHROME



PART NUMBER	SIZE	GAUGE	CASE QTY
34172	1-1/4"	20	40
34174	1-1/2"		40
34176	1-1/4"	17	40
34178	1-1/2"		30

IPS cast elbow ONLY

34171	1-1/4"
34173	1-1/2"

J BENDS FOR SINK TRAPS WITH CAPTURED NUT - CHROME



50 Pieces per case

PART NUMBER	SIZE	GAUGE
34180	1-1/4"	20
34182	1-1/2"	
34184	1-1/4"	17
34186	1-1/2"	

J BENDS FOR P TRAPS - CHROME

Without Cleanout *Reducing washer

PART NUMBER	SIZE	GAUGE
34188	1-1/4"	20
34190	1-1/2"	
*34191	1-1/2" X 1-1/4"	17
34192	1-1/4"	
*34193	1-1/2" X 1-1/4"	
34194	1-1/2"	

Low Inlet

34195	1-1/4"	17
34197	1-1/2"	

Choked Inlet

34201	1-1/2" x 1-1/4"	20
34205	1-1/2" x 1-1/4"	17

High Inlet ‡

34209	1-1/4"	17
34211	1-1/2"	17



50 Pieces per case
‡30 Pieces per case

Rough Brass

34213	1-1/2"	20
34215	1-1/2"	17

With Cleanout - Chrome

PART NUMBER	SIZE	GAUGE
34196	1-1/4"	20
34198	1-1/2"	
34199	1-1/2" X 1-1/4"	17
34200	1-1/4"	
34202	1-1/2"	
34203	1-1/2" X 1-1/4"	



LOS ANGELES CODE SINK TRAP - CAST BRASS ELBOW - GROUND JOINT

Brass nuts and 1-1/2" x 1-1/4" reducing washer



50 Pieces per case

Complete

PART NUMBER	SIZE	FINISH	GAUGE
34140	1-1/2"	Chrome	17
34142		Rough	

"J" bend ONLY for LA trap

PART NUMBER	SIZE	FINISH	GAUGE
34137	1-1/2"	Chrome	17
34139		Rough	

PART NUMBER	DESCRIPTION
34141	1-1/2" CP outlet elbow ONLY
34143	1-1/2" Rough outlet elbow ONLY

S TRAPS WITH FLANGES - LESS CLEANOUT - CHROME

To receive with deep box flange, add "BF" to part number.

All 17 gauge traps have CP brass nuts. All 20 gauge S-traps have CP die cast nuts.



PART NUMBER	SIZE	GAUGE	CASE QTY
34144	1-1/4"	20	24
34146	1-1/2"		20
34148	1-1/4"	17	20
34150	1-1/2"		18

Floor bends only without nuts

PART NUMBER	SIZE	GAUGE	CASE QTY
34152	1-1/4" x 20"	20	20
34154	1-1/2" x 20"		
34156	1-1/4" x 20"	17	
34158	1-1/2" x 20"		

CAST TEES WITH TAILPIECES - NUTS AND WASHERS - 1-1/2" CHROME



50 Pieces per case

PART NUMBER	SIZE
34312	Direct connect tee w/hiway insert
34314	End outlet tee w/ baffle
34316	Center outlet tee no baffle
34318	Center outlet tee w/ baffle
34320	3 Way slip tee no baffle
34322	1-1/2" Hiway insert tailpiece TOE



Continuous Wastes

All 17 gauge Slip Joint Cast Tee's have CP Brass nuts.
All 20 gauge Slip Joint Cast Tee's have CP Die Cast nuts.

CONTINUOUS WASTE - END OUTLET - SLIP JOINT CAST TEE WITH BAFFLE - CHROME

30 Pieces per case

* LA code



Los Angeles Code
Compliant with Baffle

PART NUMBER	SIZE	FINISH	GAUGE
34160	1-1/2" x 16"	Chrome	20
34162	1-1/2" x 21"		
34164	1-1/2" x 16"	Rough	17
*34169	1-1/2" x 16"	Rough	
34168	1-1/2" x 16"	Chrome	17
34170	1-1/2" x 21"		

CONTINUOUS WASTE - END OUTLET - DIRECT CONNECT CAST TEE WITH BAFFLE - CHROME

30 Pieces per case



PART NUMBER	SIZE	GAUGE
34286	1-1/2" x 16"	20
34288	1-1/2" x 21"	
34290	1-1/2" x 16"	17
34292	1-1/2" x 21"	

CONTINUOUS WASTE - CENTER OUTLET - SLIP JOINT CAST TEE WITH BAFFLE - CHROME

* LA code



PART NUMBER	SIZE	GAUGE	CASE QTY
34294	1-1/2" x 16"	20	24
34296	1-1/2" x 21"		
34298	1-1/2" x 16"	17	20
*34299	1-1/2" x 16"		
34300	1-1/2" x 21"		

CONTINUOUS WASTE - CENTER OUTLET - DIRECT CONNECT CAST TEE WITH BAFFLE - CHROME



PART NUMBER	SIZE	GAUGE	CASE QTY
34302	1-1/2" x 16"	20	24
34304	1-1/2" x 21"		
34306	1-1/2" x 16"	17	20
34308	1-1/2" x 21"		



Waste Arms

All 17 gauge Waste Arms have CP Brass nuts.
All 20 gauge Waste Arms have CP Die Cast nuts.

1-1/2" WASTE ARMS - SLIP JOINT - ROUGH AND CHROME



7" 60 Pieces per case
11-1/2" 50 Pieces per case
15" 40 Pieces per case
20" 30 Pieces per case
24" 24 Pieces per case

PART NUMBER	SIZE	FINISH	GAUGE
34204	7"	Chrome	20
34206	11-1/2"		
34208	15"		
34210	20"		
34212	24"		
34216	7"	Rough	20
34218	11-1/2"		
34220	15"		
34222	20"		
34224	24"	Chrome	17
34226	7"		
34228	11-1/2"		
34230	15"		
34232	20"		
34234	24"	Rough	17
34236	7"		
34238	11-1/2"		
34240	15"		
34242	20"	Rough	17
34244	24"		

1-1/2" WASTE ARMS - DIRECT CONNECT - ROUGH AND CHROME



7" 60 Pieces per case
11-1/2" 50 Pieces per case
15" 40 Pieces per case
20" 30 Pieces per case
24" 24 Pieces per case

PART NUMBER	SIZE	FINISH	GAUGE
34246	7"	Chrome	20
34248	11-1/2"		
34250	15"		
34252	20"		
34254	24"		
34256	7"	Rough	20
34258	11-1/2"		
34260	15"		
34262	20"		
34264	24"	Chrome	17
34266	7"		
34268	11-1/2"		
34270	15"		
34272	20"		
34274	24"	Rough	17
34276	7"		
34278	11-1/2"		
34280	15"		
34282	20"	Rough	17
34284	24"		

BRASS TUBULAR



**SINK TAILPIECES -
FLANGED ONE END**



4" 80 Pieces per case
6" 60 Pieces per case
8" 60 Pieces per case
12" 50 Pieces per case

PART NUMBER	LENGTH	DIAMETER	FINISH	GAUGE
34324	4"	1-1/4"	Chrome	20
34326	6"			
34328	8"			
34330	12"			
34332	4"	1-1/2"	Chrome	20
34334	6"			
34336	8"			
34338	12"			
34340	4"	1-1/2"	Rough	20
34342	6"			
34344	8"			
34346	12"			
34347	6"	1-1/4"	Chrome	17
34348	4"	1-1/2"		
34350	6"			
34352	8"			
34354	12"	1-1/2"	Rough	17
34356	4"			
34358	6"			
34360	8"			
34362	12"			

SINK TAILPIECES - DOUBLE END FLANGED - 1-1/2" - CHROME



12" 50 Pieces per case
16" 40 Pieces per case
* Rough Brass

PART NUMBER	LENGTH	GAUGE
34364	12"	20
34366	16"	
*34367	16"	
34388	16"	17

**SINK TAILPIECES - REDUCING -
1-1/2" X 1-1/4" - CHROME**



60 Pieces per case



PART NUMBER	LENGTH	GAUGE
34390	8"	20
34392		17

**EXTENSION TUBE - SLIP JOINT -
DOUBLE END - CHROME**



With CP die cast nuts
40 Pieces per case

PART NUMBER	SIZE	GAUGE
34394	1-1/4" X 16"	20
34396	1-1/2" X 16"	



EXTENSION TUBES - SLIP JOINT - WITH NUTS AND WASHERS - CHROME

All 17 gauge Slip Joint Extension Tubes have CP brass nuts

All 20 gauge Slip Joint Extension Tubes have CP die cast nuts



6" 80 Pieces per case

8" 60 Pieces per case

12" 50 Pieces per case



PART NUMBER	LENGTH	DIAMETER	GAUGE	FINISH
34398	6"	1-1/4"	20	Chrome
34400	8"			
34402	12"			
34404	6"	1-1/4"	17	Chrome
34406	8"			
34408	12"			
34410	6"	1-1/2"	20	Chrome
34412	8"			
34414	12"			
34416	6"	1-1/2"	17	Chrome
34418	8"			
34420	12"			
34422	12"	1-1/2"	17	Rough

EXTENSION TUBES - SOLDER - CHROME



6" 80 Pieces per case

8" 60 Pieces per case

12" 50 Pieces per case



PART NUMBER	LENGTH	DIAMETER	GAUGE
34424	6"	1-1/4"	20
34426	8"		
34428	12"		
34430	6"	1-1/4"	17
34432	8"		
34434	12"		
34436	6"	1-1/2"	20
34438	8"		
34440	12"		
34442	6"	1-1/2"	17
34444	8"		
34446	12"		

BRASS TUBULAR



**EXTENSION TUBES
THREADED BOTH ENDS
CHROME OR ROUGH**

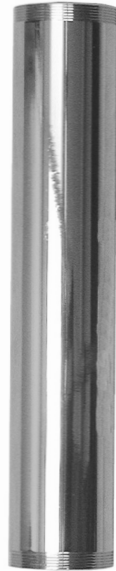

*Extension tube - threaded one end - (TOE)



6" 80 Pieces per case
8" 60 Pieces per case
12" 50 Pieces per case

PART NUMBER	LENGTH	DIAMETER	FINISH	GAUGE
34448	6"	1-1/4"	Chrome	20
34450	8"			
34452	12"			
34454	6"	1-1/4"	Rough	20
34456	8"			
34458	12"			
34460	6"	1-1/4"	Chrome	17
34461*	6"			
34462	8"			
34464	12"			
34467	3-3/4"	1-1/2"	Chrome	20
34468	6"			
34470	8"			
34472	12"			
34474	6"	1-1/2"	Rough	20
34476	8"			
34478	12"			
34480	12"	1-1/2"	Chrome	17
34482	12"	1-1/2"	Rough	17

**REPAIR COUPLINGS AND ELLS
CHROME**



With CP die cast nuts
25 Pieces per case

PART NUMBER	DESCRIPTION	SIZE
34518	Straight	1-1/4
34520	90°	
34522	45°	
34524	Straight	1-1/2
34526	90°	
34528	45°	



DOUBLE OFFSET 12"



With die cast nuts
24 Pieces per case



PART NUMBER	SIZE	GAUGE	FINISH
34530	1-1/4"	20	Chrome
34532	1-1/2"		Rough
34534	1-1/2"		



**SLIP JOINT CHROME
REPAIR TRAPS -
LESS CLEANOUT**



PART NUMBER	SIZE	GAUGE
34484	1-1/4"	20
34486	1-1/2"	

Replacement elbow ONLY

PART NUMBER	LENGTH	GAUGE
34488	1-1/4"	20
34490	1-1/2"	

SLIP JOINT ELBOWS

With CP die cast nuts



PART NUMBER	LENGTH	SIZE	GAUGE	FINISH
34492	4"	1-1/4"	20	Chrome
34494	6"			
34496	8"			
34498	12"			Rough
34500	4"			
34502	6"			
34504	8"	1-1/2"	Chrome	
34506	12"			
34508	7"			
34510	7"	Rough		

CLOSET ELLS

With CP die cast nuts



PART NUMBER	SIZE	GAUGE	FINISH
34512	2" x 4" x 6"	20	Chrome
34514	2" x 5" x 7"		
34516	2" x 6" x 8"		
*34517			

* Repair Ell

**BRANCH TAILPIECES - BRANCH
FOR 7/8" DISHWASHER DRAIN HOSE**



17 Gauge with CP brass nuts
20 Gauge with CP die cast nuts
25 Pieces per case
34540 w/ captive nut
34542, 34544 w/ nut down

PART NUMBER	SIZE	GAUGE	FINISH
34540	1-1/2" x 8"	17	Chrome
34542	1-1/2" x 8"	20	Rough
34544	1-1/2" x 8"	20	Chrome

**DISPOSER KIT - CHROME
13" CENTER TO END**

With baffle tee
17 gauge with CP brass nuts
20 gauge with CP die cast nuts
30 Pieces per case



PART NUMBER	SIZE	GAUGE
34546	1-1/2"	20
34548		17

BRASS TUBULAR



SEMI - CAST TRAPS - CLEANOUT - BRASS NUTS - CHROME - 9" WALL BEND



20 Pieces per case

	PART NUMBER	SIZE	GAUGE
With shallow flange	34550	1-1/4"	17
	34554	1-1/2"	

	PART NUMBER	SIZE	GAUGE
With box flange	34556	1-1/4"	17
	34558	1-1/2"	

	PART NUMBER	SIZE	GAUGE
With ground joint	34560	1-1/4"	17
	34562	1-1/2"	

CAST SWIVEL TRAP - CLEANOUT - BRASS NUTS - CHROME - IPS ELBOW - GROUND JOINT



25 Pieces per case

PART NUMBER	SIZE	GAUGE
34570	1-1/2"	17

COMMERCIAL GRID STYLE LAVATORY DRAIN



Chrome plated cast brass strainer
1-1/4" x 6" -17 gauge chrome plated brass tail piece
Brass locknut

PART NUMBER
1176

COMMERCIAL GRID STYLE LAVATORY DRAIN

Wheel chair accessible
Chrome plated cast brass strainer and elbow
1-1/4" x 9" -17 gauge chrome plated brass tail piece
Brass locknut



PART NUMBER	DESCRIPTION
1177-TP	With tailpiece
1177	Elbow ONLY



LAVATORY HANGER

For Iron Lavatories
Cast iron
10-1/2" Wide
Extra heavy cast iron

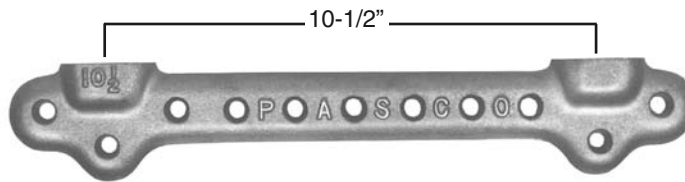

Made in U.S.A.

**PART
NUMBER
1219**

LAVATORY HANGER

For China Lavatories

Stamped steel
Supplied in pairs

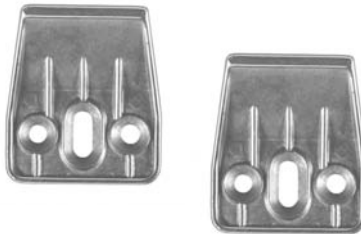

Made in U.S.A.

**PART
NUMBER
1220**

"Z" HANGER

Adjustable For Enameled Iron or China Lavatories

For iron, side lugs fit the pockets
For china, knock off the side lugs
5" to 16" adjustment
Cast iron



**PART
NUMBER
1221**

LAVATORY HANGER

For China Lavatories

Stamped steel
Plated for corrosion resistance
8" wide
Made in U.S.A.

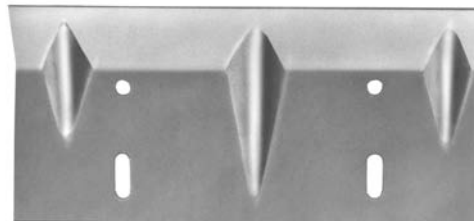

**PART
NUMBER
1222**

AMSTAN STYLE LAVATORY HANGER

Designed to fit Amstan Style
Lavatories

Stamped steel
Plated for corrosion resistance
10-1/2" wide

Made in U.S.A.

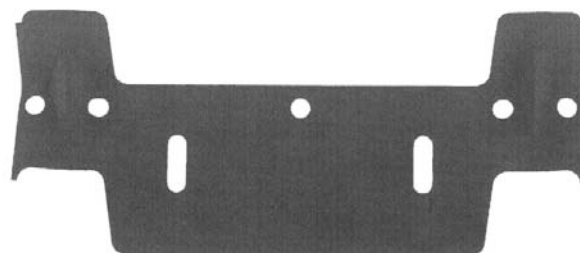

**PART
NUMBER
1223**



TUB SPOUTS



Chrome plated brass or die cast
5-5/8" Length

PART NUMBER	MATERIAL	FINISH	MOUNT	FPT
1115	Brass	Chrome	Front	1/2"
1126	Brass	Chrome	Back	1/2" - 3/4"
1134	Die Cast	Chrome	Front	1/2"
1134-AB	Die Cast	Ant. Brass	Front	
1134-PB	Die Cast	Pol. Brass	Front	

DIVERTER SPOUTS, FRONT LIFT



Chrome plated brass or die cast
5-5/8" Length
Front mount

PART NUMBER	MATERIAL	FINISH	FPT
1117	Brass	Chrome	1/2"
1128	Die Cast	Chrome	
1128-AB	Die Cast	Ant. Brass	
1128-PB	Die Cast	Pol. Brass	

ADJUSTABLE TUB AND DIVERTER SPOUTS

COPPER OR IPS



Chrome plated die cast
5-5/8" Length

PART NUMBER	FINISH	ADJUST.	DIVERTER	PIPE SIZE
1136	Chrome	2-1/4"	No	1/2" CWT
1142	Chrome	2-1/4"	Yes	
1142-PB	Pol. Brass	2-1/4"	Yes	
1143	Chrome	1"	No	1/2"-3/4" IPS
1144	Chrome	1"	Yes	



DIVERTER SPOUTS, BACK LIFT



Chrome plated brass or die cast
5-5/8" Length
Back mount

PART NUMBER	MATERIAL	FPT
1127	Brass	1/2"
1129	Brass	3/4"
1137	Die Cast	1/2"
1138	Die Cast	3/4"
1140	Die Cast	1/2" - 3/4"

7" LONG DIVERTER AND TUB SPOUTS

Available in four styles
Chrome plated die cast
Individually boxed
Diverter are front lift
IPS are front mount
CWT are slip fit



PART NUMBER	DIVERTER	PIPE SIZE
11287	Yes	1/2" IPS
11347	No	
11367	No	1/2" CWT
11427	Yes	

Available in polished brass add "B"
to part number

EXTENSIONS FOR TUB AND DIVERTER SPOUTS

Chrome Plated or Polished Brass



Spouts not included
Made In U.S.A.

PART NUMBER	FINISH	LENGTH
1155	Chrome	3"
1155-PB	Brass	
1156	Chrome	4-3/4"
1156-PB	Brass	



FIBERGLASS SHOWER ARM ELL

This brass ell securely mounts a shower arm to a fiberglass shower stall. Also can be used to secure a tub spout nipple. Can be used with copper, iron pipe or compression fittings. Prevents movement of shower arm and tub spout.



Locknuts secure ell to fiberglass wall
Requires 1-1/32" hole through fiberglass
Outlet end 1/2" FIP
Inlet end 1/2" CWT or 1/2" MPT

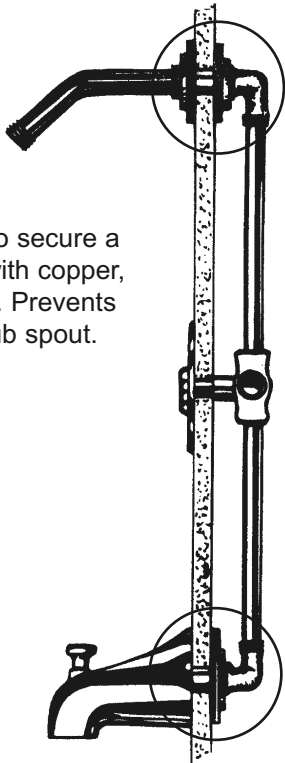

PART NUMBER
1195

BATHCOCK COUPLING

1/2" MPT
Satin finish brass
Sold by the pair



PART NUMBER
1793

DIVERTER SPOUT For Hand Held Shower

Chrome plated die cast
1/2" male hose adapter included for hand shower hose
1/2"-3/4" IPS Back mount



PART NUMBER	FIP	PROTRUSION FROM WALL
1133	1/2" or 3/4"	5-1/8"

SOLID BRASS TWIN ELL
For use with Diverter Spouts



PART NUMBER	SIZE NPT		
	SPOUT	IN	SHOWER
1145	3/4"	1/2"	1/2"

BATH SUPPLIES FOR 4 LEG OR OLD STYLE BATH TUBS

2 Styles With Nuts and Washers

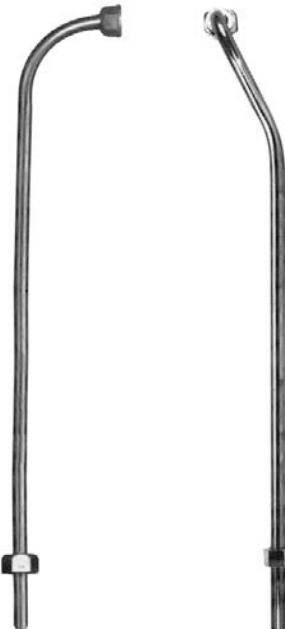

1/2" Chrome plated copper

PART NUMBER	DESCRIPTION
1792	90° Single bend For 3-3/8" Centers
17925	Offset Bend For 3-3/8" to 4" Centers
1794	KIT ONLY 2 Each of nuts, cone washers & friction rings



Shower Valve Rebuild Kits

For the most popular brands

These conveniently packed kits contain all the necessary parts needed to rebuild shower valves.

Price Pfister Verve®

3 Handle Valve w/ Diverter
 Sold complete as shown
 Seats included
 For separate parts see pages
 B-47,49,50



PART NUMBER	DESCRIPTION
28314	Two Handle
28315	Three Handle

Sayco®

3 Handle Valve w/ Diverter
 Sold complete as shown
 Seats included
 Parts **not** sold separately

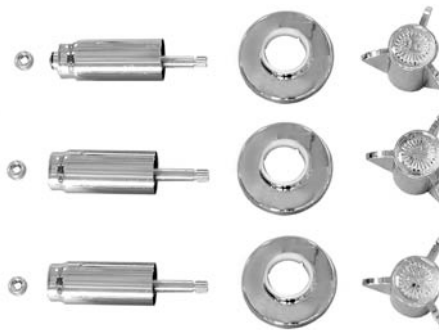

PART NUMBER
28317

American Standard - Colony®

3 Handle Valve w/ Diverter
 Sold complete as shown
 Seats included
 Parts **not** sold separately



PART NUMBER	STEM LENGTH
28310	Short
28311	Long

American Standard - Aquaseal®

3 Handle Valve w/ Diverter
 Sold complete as shown
 Seats included
 Parts **not** sold separately



PART NUMBER
28312



Gerber®

3 Handle Valve w/ Diverter
 Sold complete as shown
 Seats included
 Parts **not** sold separately

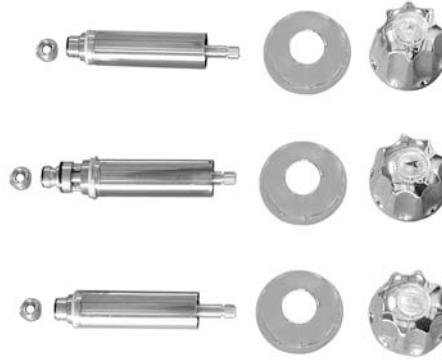

PART NUMBER	PART NUMBER
28319	Canopy
28320	Cross <small>(not shown)</small>

Sterling®

3 Handle Valve w/ Diverter
 Sold complete as shown
 Seats included
 Parts **not** sold separately



PART NUMBER
28318

Kohler®

2 Handle Valve
 Sold complete as shown
 Seats included
 Parts **not** sold separately



PART NUMBER
28321

Central Brass®

3 Valve Diverter
 Sold complete as shown
 Seats included
 Parts **not** sold separately

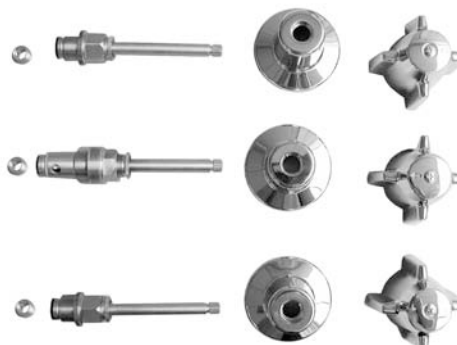

PART NUMBER
28322

NOTE: Please do not confuse **PASCO** Specialty & Mfg., Inc. with these companies. **PASCO** is an independent manufacturing redistributor of quality plumbing specialty products, which, although may not be manufactured by the original product manufacturer, are precision made.



SIMPLY THE BEST SHOWER HEAD

1/2" FPT
 Easily adjusts from fine to peppery spray
 Chrome plated brass ball joint
 Vandal resistant
 2.5 GPM @ 70 PSI
 Removable filter screen prevents clogging of spray



PART NUMBER
1167

ECONOMY SHOWER HEAD

1/2" FPT
 2.75 GPM @ 70 PSI
 Chrome plated plastic
 Adjustable



PART NUMBER
1189-RF

SHOWER ARM SHUT OFF

1/2" MPT x 1/2" FPT
 Chrome plated brass



PART NUMBER
1168

**Shower head will still dribble after shut off to prevent back flow.*

HIGH RISE SHOWER ARM

Increases height of any shower head
 Chrome plated brass
 1/2" IPS

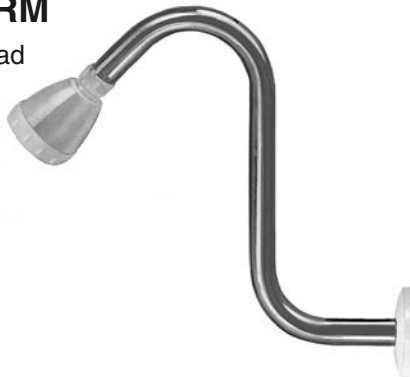

PART NUMBER	HEIGHT	FINISH
1190	10"	Chrome
1190-PB		Pol. Brass
1191		Chrome
1191-PB		Pol. Brass

Sold less shower head and flange.

SHOWER ARMS

Chrome plated brass
 1/2" IPS - Heavy wall thickness



PART NUMBER	SIZE	FINISH
1185	6"	Chrome
1185-PB		Pol. Brass
1186	8"	Chrome
1186-PB		Pol. Brass
1193	10"	Chrome



SHOWER ARM FLANGES



PART NUMBER	FLANGE STYLE	FINISH
1181	Sure Grip	CP Brass
1182	Sure Grip	CP Steel
1187	Set Screw	CP Die Cast

FACE BUSHINGS - IPS AND CWT (SOLDER TYPE)

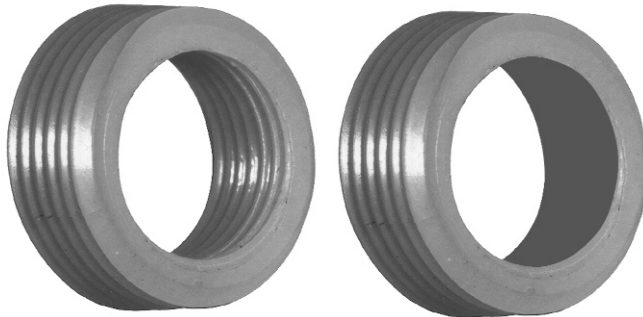

PART NUMBER	MATERIAL	SIZE
1139	Plastic	3/4" x 1/2" IPS
1141	Brass	
1146	Brass	1/2" x 3/8" IPS
1317	Brass	1/2 IPS x 1/2" CWT
1318	Brass	3/4" IPS x 3/4" CWT
1319	Brass	1" IPS x 1" CWT

DIVERTER SPOUT LIFT REPLACEMENT

Fits Spouts:

1128, 1134, 1136, 11287, 11427
1142, 1143 & 1144

- Brass lift
- Rubber washer
- Plastic slide
- Installs in seconds

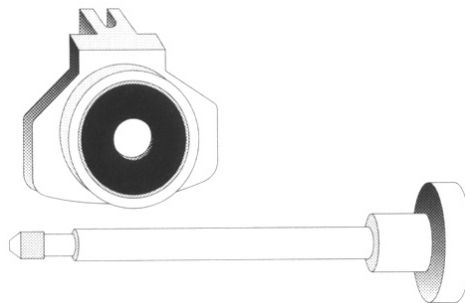

PART NUMBER
1109

ADJUSTABLE SHOWER ARM

1/2" MPT x 1/2" FPT
10" Length
Chrome plated brass

Locking wingnuts allow any height adjustment.



PART NUMBER	DESCRIPTION
1192	Shower arm LESS shower head
1192-RK	Washers and Gaskets



QUICK VALVE PLATE

Stainless Steel Shower Valve Cover Plate

Old ceramic tile is impossible to match. The Quick Valve Plate covers the unsightly hole left in the tile after the shower valve is replaced.



Stainless

PART NUMBER	HOLES	HOLE SIZE OR CENTERS
815	1	5"
816	2	8" Centers
817	3	
818	1	3-1/2"
819	1	4-1/2"
820	0	No Holes

Polished Brass Finish

PART NUMBER	HOLES	HOLE SIZE OR CENTERS
815-PB	1	5"
816-PB	2	8" Centers
817-PB	3	
818-PB	1	3-1/2"
819-PB	1	4-1/2"
820-PB	0	No Holes

Screws and brackets provided
Polished stainless steel not affected by household cleaners
13" long X 7-1/4" wide

OVERFLOW PLATE

With Trip Lever

Square handle
Covers 3-1/4" hole
2" bolt hole centers



PART NUMBER	FINISH	W/1148 BOLTS
1150	Chrome	NONE
1150-PB	Pol. Brass	
1157	Chrome	2
1157-PB	Pol. Brass	

OVERFLOW PLATE

Covers 3-1/4" hole
2" bolt hole centers



PART NUMBER	FINISH	W/1148 BOLTS
1154	Chrome	NONE
1160	Chrome	
1160-PB	Pol. Brass	2

OVERFLOW PLATE

Covers 3-1/4" hole



PART NUMBER	FINISH	W/1148 BOLT
1152	Chrome	NONE
1159	Chrome	
1159-PB	Pol. Brass	

OVERFLOW PLATE BOLT

For trip lever and overflow face plates

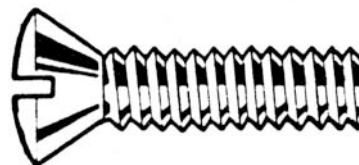

PART NUMBER	FINISH
1148	CP Brass
1148-AB	Ant. Brass
1148-PB	Pol. Brass
1149*	CP Brass

Size 1/4" X 20 x 1-1/2"
* 2 Per bag



TUB STRAINER
Three Prong



Stainless steel

PART NUMBER	DIAMETER
1342	1-7/8"
1343	1-5/8"

OVERFLOW STRAINER
For 4 leg tubs



3" Diameter
CP Brass

PART NUMBER
1357

BEAD CHAIN



PART NUMBER	REEL LENGTH	CHAIN MATERIAL
1122	250 FT.	CP Steel
1124	250 FT.	CP Brass

PART NUMBER	TYPE	CHAIN SIZE	MATERIAL
1130	B	# 10	CP Brass
1131	A	# 10	CP Brass

BATH TUB WASTE SHOE AND STRAINER



Brass
22 Gauge tube
Price Pfister style

PART NUMBER	DESCRIPTION
1372	1-1/2" Brass Waste Shoe
1373	1-3/8" Brass Waste Shoe
1374	16 Thread Tub Drain Body -W/Cross
1374-W	Tub Drain Washer
1376	Stainless Steel Strainer -W/Bolt
1377	CP Brass Bolt For Strainer ONLY
1380	1-1/2" Brass Waste Shoe- Complete
1381	1-3/8" Brass Waste Shoe- Complete



**ADD - A - SHOWER
Over The Rim**

Chrome plated die cast spout
1/2" IPS



PART NUMBER	DESCRIPTION
2825	Over the rim supplied complete as shown

Replacement Parts

2831	Spout ONLY
1246	Wall Bracket
2836-3	3/8" X 60" CP Brass Riser
1189-RF	Shower Head w/Bushing

**ADD - A - SHOWER
Regular Style**

Chrome plated brass bath cock
Specifically for 4 leg bathtubs



PART NUMBER	DESCRIPTION
2826	Regular style bathcock 3-3/8" centers supplied complete as shown

Replacement Parts

2832	Bathcock ONLY
1247	Wall Bracket w/Rod
2836-3	3/8" X 60" CP Brass Riser
1189-RF	Shower Head w/Bushing
1258	Rod - To - Riser Adapter
2837-C	Cold Stem
2837-H	Hot Stem
2837	Bathcock Seats-Pair
2839	Hot & Cold Handle Set

**ADD - A - SHOWER
Non - Siphon**

Complies with UPC
Spout rises above rim of tub

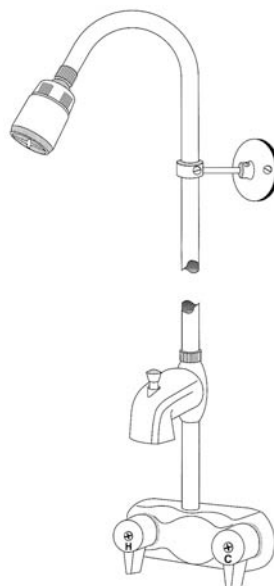

PART NUMBER	DESCRIPTION
2827*	Non - Siphon bathcock 3-3/8" centers supplied complete as shown

Replacement Parts

2833	Bathcock ONLY
1247	Wall Bracket w/Rod
2836-3	3/8" X 60" CP Brass Riser
1189-RF	Shower Head w/Bushing
1258	Rod - To - Riser Adapter
2837-C	Cold Stem
2837-H	Hot Stem
2838	Bathcock seats-Pair
2839	Hot & Cold Handle Set

*Complies with UPC



STRAIGHT SHOWER RODS



1" Diameter

PART NUMBER	ROD LENGTH	DESCRIPTION
1260	60"	Polished Aluminum LESS Flange
1261	72"	
1282	60"	CP Brass WITH Flange
1283	72"	
1282-PB	60"	Polished Brass WITH Flange
1283-PB	72"	

CORNER SHOWER RODS

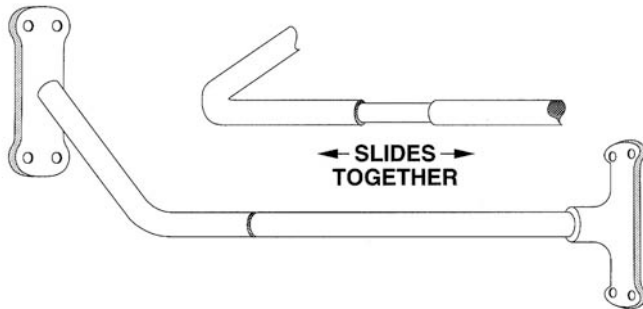

1" Diameter
Jumbo flanges
Individually boxed

PART NUMBER	ROD LENGTH	DESCRIPTION
1262	60" x 27"	Polished Aluminum
1263	72" x 27"	
1284	60" x 27"	Chrome Plated Brass
1285	72" x 27"	

"D" STYLE SHOWER RODS

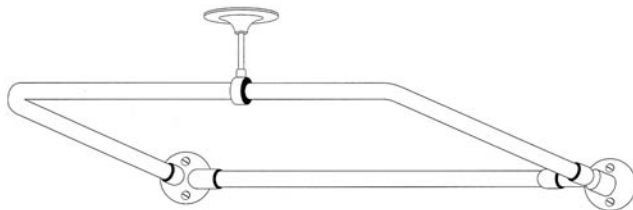

1" Diameter
Round flanges & 36" Ceiling support
Individually boxed

PART NUMBER	LENGTH X WIDTH	MATERIAL
1264	54" x 27"	Polished Aluminum
1265	60" x 27"	
1286	54" x 27"	Chrome Plated Brass
1287	60" x 27"	

RECTANGULAR SHOWER RODS

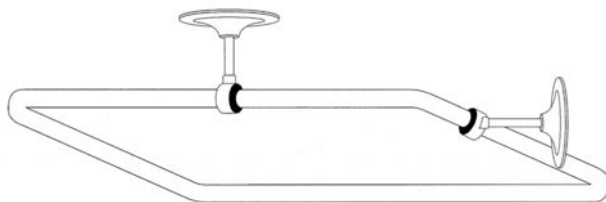

1" Diameter
1-36" Ceiling support
1-10" Wall support
Round flanges
Individually boxed

PART NUMBER	LENGTH X WIDTH	MATERIAL
1271	48" x 27"	Polished Aluminum
1272	54" x 27"	
1288	48" x 27"	Chrome Plated Brass
1289	54" x 27"	



**FLANGES
FOR 1" SHOWER RODS**

1248 Fits ID

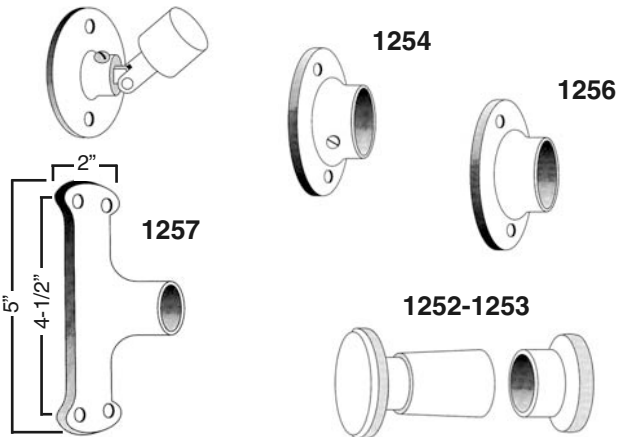

PART NUMBER	DESCRIPTION
1248	Hinged wall CP brass with screws
1252	Adjustable CP Die Cast
1253	Adjustable CP plastic
1254	With set screw CP steel
1256	Sure grip CP steel
1257	Jumbo CP die cast
1258	Riser to Rod Support

**SHOWER CURTAIN PINS
ALSO USE FOR VALVE ID TAGS**

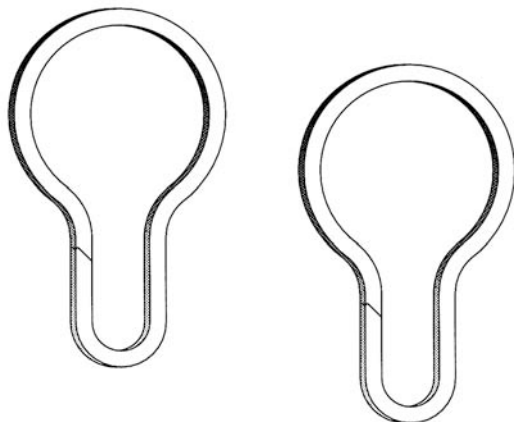

PART NUMBER	SIZE	MATERIAL
1188	#3	Nickel Plated Steel

**CEILING SUPPORTS
FOR 1" SHOWER RODS**

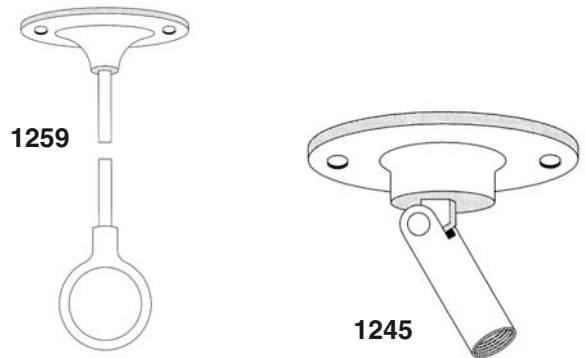

PART NUMBER	DESCRIPTION
1259	36" Fit-all ceiling support complete
1245	Hinged ceiling support for angled ceilings fits 1259 rods CP brass, sold less rod
1259-R	36" CP rod ONLY 1/4" x 20T, One End
1249	Ceiling flange ONLY
1267	1" Loop ONLY

ADD-A-SHOWER RISER BRACKETS

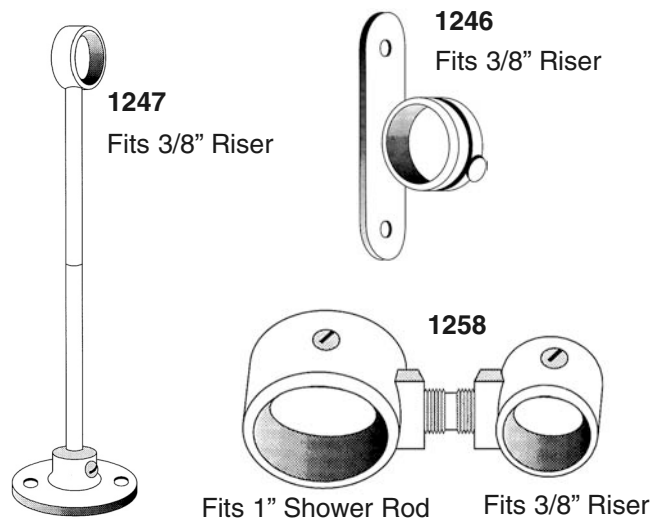

PART NUMBER	DESCRIPTION
1246	Fixed wall brackets for risers
1247	Bracket for risers
1258	Rod to riser coupling
1269	Rod Coupling Loop for 1264&1265



2" QUICK SET SHOWER DRAIN

For fiberglass shower stalls

Internal locknut and gasket for 2" DWV
 Chrome plated brass strainer
 Brass body and locknut



PART NUMBER	PIPE SIZE
7980	2"

BRASS UTILITY DRAIN



PART NUMBER	IPS
1170	1-1/2"
1171	2"

*See Page D-1
**CAST IRON
 SPECIALTIES**
 For Additional
 Shower Drains*

PLASTIC SHOWER DRAIN

Clamping Ring Style



4" diameter strainer
 2" IPS plastic tailpiece allows adjustment to desired level
 Fits over 2" or inside 3" Schedule 40 DWV

PART NUMBER	MATERIAL	DRAIN CONNECTION	TOP FLANGE DIAMETER	BOTTOM FLANGE DIAMETER
8015	PVC	2"-3" PVC	5-1/4"	6-1/2"
8016	ABS	2"-3" ABS		
8019	4" STAINLESS STEEL STRAINER			



SURE GRIP FLANGES

Chrome Plated Brass

PART NUMBER	IPS	CWT	OUTSIDE DIAMETER
1226-CB	1/2"	--	2-1/2"
1227-CB	3/4"	--	2-1/2"
1228-CB	1-1/2"	--	3-1/2"
1229-CB	2"	--	3-1/2"
1230-CB	--	1/2"	2-1/2"
1231-CB	--	3/4"	2-1/2"

Chrome Plated Steel

PART NUMBER	IPS	CWT	OUTSIDE DIAMETER
1224	1-1/2" Tubular		3"
1225	3/8"	--	2-1/2"
1226	1/2"	--	2-1/2"
1227	3/4"	--	2-1/2"
1228	1-1/2"	--	3"
1229	2"	--	3-1/4"
1230	--	1/2"	2-1/2"
1231	--	3/4"	2-1/2"
1232	1-1/4"	1-1/2"	3"
1233	1"	--	2-3/4"
1240	--	2"	3-1/2"
1241	--	1"	2-3/4"
1244	1-1/4" Tubular		3"

SURE GRIP BOX FLANGES



Chrome Plated Steel

PART NUMBER	IPS	TUBULAR	OUTSIDE DIAMETER
1234	1-1/4"	--	3"
1235	1-1/2"	--	3"
1236	--	1-1/4"	3"
1237	--	1-1/2"	3"

EXTRA WIDE SURE GRIP FLANGES



Chrome Plated Steel

PART NUMBER	IPS	TUBULAR	OUTSIDE DIAMETER
1238	1-1/2"	--	3-1/2"
1239	2"	--	3-1/2"
1243	--	2"	3-1/2"

SURE GRIP BELL FLANGES



Chrome Plated Steel

PART NUMBER	IPS	CWT	TUBULAR	OUTSIDE DIAMETER
2841	3/8"	--	--	2-1/2"
2842	1/2"	--	--	2-1/2"
2844	1-1/4"	--	--	3"
2845	--	1/2"	--	2-1/2"
2846	1-1/2"	--	--	3"
2848	--	3/8"	--	2-1/2"
2853	--	--	1-1/4"	3"
2854	--	--	1-1/2"	3"



SPLIT-ONE™

FLOOR AND CEILING PLATE

Simply bend and place around pipe.
Made in the U.S.A.

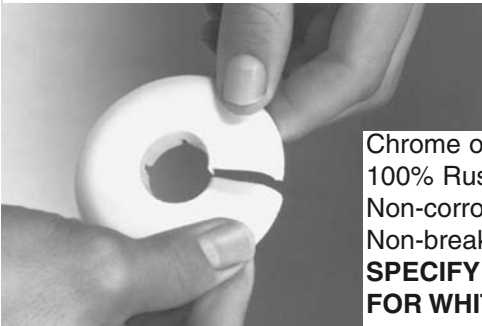

Chrome or white finish
100% Rustproof
Non-corrosive
Non-breakable
**SPECIFY SUFFIX "W"
FOR WHITE**

PART NUMBER	IPS	CWT	OUTSIDE DIAMETER
2856	1/2"	--	2-3/4"
2857	3/4"	--	3"
2858	1"	--	3-1/4"
2859	1-1/4"	--	3-1/2"
2860	1-1/2"	--	4-1/4"
2861	2"	--	4-1/4"
2862	2-1/2"	--	5-1/4"
2863	3"	--	5-3/4"
2864	4"	--	6-3/4"
2865	5"	--	8-1/2"
2866	6"	--	9-3/4"
2868	8"	--	12-3/4"
2873	--	1/2"	2-1/2"
2874	--	3/4"	2-3/4"
2875	--	1"	3"
2876	--	1-1/4"	3-1/4"
2877	--	1-1/2"	3-1/2"
2878	--	2"	4-1/2"

FLOOR AND CEILING PLATE

Sure Grip

Chrome plated steel
Light pattern - no springs



PART NUMBER	IPS	CWT	OUTSIDE DIAMETER
2810	3/8"	--	3"
2811	1/2"	--	2-3/4"
2812	3/4"	--	2-3/4"
2813	1"	--	3-1/2"
2814	1-1/4"	1-1/2"	3-1/2"
2815	1-1/2"	--	3-1/2"
2816	2"	--	4-1/2"
2820	--	3/8"	2-3/4"
2821	--	1/2"	3"
2822	--	3/4"	2-3/4"
2823	--	1"	2-3/4"
2824	--	1-1/4"	3-1/2"

FLOOR AND CEILING PLATE

Heavy Pattern With Springs - Hinged

Chrome plated steel



PART NUMBER	IPS	CWT	OUTSIDE DIAMETER
2880	3/8"	--	2-1/4"
2881	1/2"	--	2-3/4"
2882	3/4"	--	2-3/4"
2883	1"	--	3-1/4"
2884	1-1/4"	--	3-1/2"
2885	1-1/2"	--	4"
2886	2"	--	4-1/2"
2888	--	1/2"	2-1/4"
2889	2-1/2"	--	5-1/2"
2890	3"	--	6"
2891	--	3/4"	2-3/4"
2892	4"	--	6-1/2"
2893	--	1"	3-1/4"
2894	--	1-1/4"	3-1/2"
2895	--	2"	4-1/2"
2896	--	1-1/2"	4"
9860	5"	--	9"
9861	6"	--	9-3/4"
9862	8"	--	13"



PLASTIC DRYER VENT HOOD
With 4" Aluminum Duct Pipe and Wall Flange



Weather resistant
Paintable
Wide outlet

PART NUMBER
1718-W

PLASTIC LOUVERE DRYER VENT HOOD
With 4" Aluminum Duct Pipe and Wall Flange

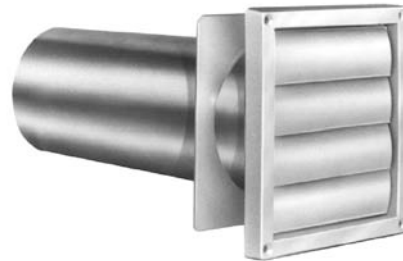

Weather resistant
Paintable
Narrow profile
Prevents drafts

PART NUMBER
1721-W

VENT HOOD KIT
With Above Hood

- 1- 4" x 5 ft. Vinyl or Aluminum Dryer Duct
- 2- #1724 Clamps
- 1- #1718-W Vent Hood

PART NUMBER	DESCRIPTION
1697	Aluminum
1718-HK	Vinyl

LOUVERED VENT HOOD KIT
With Above Hood

- 1- 4" x 5 ft. Vinyl or Aluminum Dryer Duct
- 2- #1724 Clamps
- 1- #1721-W Vent Hood

PART NUMBER	DESCRIPTION
1698	Aluminum
1721-LK	Vinyl

VINYL OR ALUMINUM DRYER DUCT

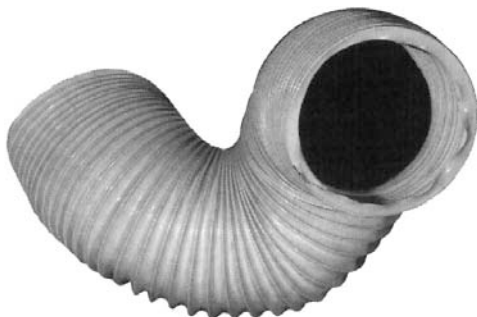

PART NUMBER	MATERIAL	SIZE
1687	Aluminum	4" x 5 ft.
1688		4" x 8 ft.
1689		4" x 25 ft.
1720	Vinyl	4" x 20 ft.
1720-5		4" x 5 ft.

DRYER DUCT CLAMP
Stainless Steel



PART NUMBER	SIZE
1723	4"



ANCHOR SETS

Phillips hex head screws allow a nutdriver, nut setter or screwdriver to be used.

EACH SET CONTAINS:

- 100 Anchors
- 100 Phillips hex head screws
- Carbide tipped masonry drill (optional)
- Transparent, reusable box



PART NUMBER	DRILL INCLUDED	SCREW SIZE	ANCHOR SIZES	STYLE
1598	3/16"	1" x # 6	4 - 6	Collar
1599	None	1" x # 10	8 - 10	
1600	1/4"	1" x # 10	8 - 10	
1602	3/16"	1" x # 6	4 - 6 - 8	No Collar
1604	1/4"	1" x # 10	10 - 12	

FELT PIPE WRAP



Soundproofs and insulates pipe
 Helps prevent pipe clatter
 Self-adhering adhesive peel back

PART NUMBER	THICKNESS	WIDTH	LENGTH
2640	1/4"	2"	25'
2642	3/16"	2"	25'

CUT LENGTH OAKUM



Convenient, labor saving cut lengths
 Non-spitting
 Contains no tar
 Made to pack well, caulks tight
 Treated with a special compound so that it expands when wet
 Lead ladles, Lead pots Joint runners and caulking tools can be found on pages D-26 in the tools section

PART NUMBER	DESCRIPTION
2899	1 Pound Bag with 4 pieces
2897	Small box with 24 pieces of 27 inch lengths
2898	Large case with 10 boxes of # 2897



TOGGLE BOLTS

50 per box



PART NUMBER	SIZE
1475	3/16" x 3"
1479	3/16" x 4"
1484	1/4" x 3"
1485	1/4" x 4"

FLAT HEAD WOODSCREWS

"P" indicates phillips head
100 per box



STEEL	BRASS	SIZE	LENGTH
--	1502	# 12	1-1/4"
1521	1503-P		1-1/2"
1504-P	--		2"
1523	1505-P	# 14	1-1/2"
1541	1531		2"
1543	--		

ALL THREAD ROD COUPLING

Plated steel



PART NUMBER	SIZE
1547	3/8" x 16T x 1-1/8"
1548	3/8" x 16T x 1-3/4"

STOVE BOLTS

Round head with hex nuts

100 bolts and nuts per box



PART NUMBER	SIZE
1635	3/16" x 3/4"
1636	3/16" x 1"
1637	3/16" x 1-1/4"
1639	1/4" x 1/2"
1640	1/4" x 3/4"
1641	1/4" x 1"
1642	1/4" x 1-1/4"
1643	1/4" x 1-1/2"
1644	1/4" x 2"

nuts only

PART NUMBER	SIZE
1645	3/16" x 10-24T
1646	1/4" x 20T

SETTING TOOL

Plated steel



PART NUMBER	SIZE
1552	3/8" or 1/2"

DROP IN CONCRETE ANCHORS



100 per box
Complies
ICBO # 3631
RR# 24682

PART NUMBER	SIZE
1558	3/8"
1559	1/2"

SHEET METAL SCREWS



*#1831 Hex slotted self-drilling type
Hex slotted 1/4" Hex head
Plated 100 per box

PART NUMBER	SIZE	LENGTH
*1831-100	# 7	5/8"
1817	# 8	1/2"
1819		3/4"
1821		1"
1871	#10	3/4"
1873-P		1"

DRIVE SCREWS



100 per box

PART NUMBER	SIZE
1555	2" x # 16

SELF-DRILLING SCREWS

100 per box
Self-drilling point
1/4" hex head



PART NUMBER	SIZE
1830	1/2" X # 8



HEX SCREW AND NUT SETTER



Use with 1/4" drill to drive hex sheet metal and anchor screws.
Magnetic socket
Heat treated
1/4" Drill shank
1-3/4" Length

PART NUMBER	SOCKET SIZE	BODY DIAMETER
1594	1/4"	7/16"
1595	5/16"	1/2"

STEEL EYE SOCKETS
Flat and Offset



2-5/8" Length



1-7/8" Length

Plated
3/8" N.S.T.
100 per box

PART NUMBER	DESCRIPTION
1556	Flat
1557	Offset

"J" Nail



For 1/2" or 3/4" CWT
Copper clad
100 per box
Made in U.S.A.

PART NUMBER
1590

SELF - NAILING PROTECTION PLATE



100 per box
Made in U.S.A.

PART NUMBER	SIZE	UNCOATED
1628	2" x 5"	20
1630		16

WIRE PIPE HOOKS



50 per box

Made in U.S.A.

PLASTIC COATED	SIZE	UNCOATED
1580	1/2" x 4"	--
1581	1/2" x 6"	1561
1584	3/4" x 4"	1564
1585	3/4" x 6"	1565
--	3/4" x 8"	1566
--	3/4" x 10"	1567
--	1" x 6"	1569

PIPE STRAPS



Made in U.S.A.

1" Copper clad nails

PART NUMBER
1664

Galvanized

PART NUMBER	IPS SIZE
1614-I	1/2"
1615-I	3/4"
1616-I	1"
1617-I	1-1/4"
1618-I	1-1/2"
1619-I	2"
1620	2-1/4"
1621	3"
1622	4"

Copper Clad

PART NUMBER	CWT
1623*	1/2"
1624*	3/4"
1625*	1"
1626	1-1/4"
1627	1-1/2"
1632	2"

Pure Copper

PART NUMBER	CWT
1650-C*	1/2"
1651-C*	3/4"
1652-C*	1"
1653-C	1-1/4"
1654-C	1-1/2"
1655-C	2"

* With nails

See price page for quantity pack



SILLCOCK KEY



Die Cast

PART NUMBER	SIZE
1699	1/4"
1700	5/16"

HEATER FURNACE LOGLIGHTER KEYS



Die Cast

PART NUMBER	SIZE	STEM LENGTH
1704	1/4"	2-1/4"
1705	5/16"	
1706	1/4"	10"
1707	5/16"	

FOUR WAY KEY

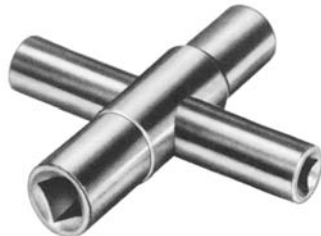

Fits stopcocks,
sillcocks and valves
Sizes are 1/4" to 9/32" and
5/16" to 11/32
Precision machined plated steel

PART NUMBER
1701

COPPER THERMOCOUPLES



WATER HEATER EARTHQUAKE STRAP



Fits up to 50 gal. water heater

PART NUMBER
1725

PART NUMBER	LENGTH
9500	18"
9501	24"
9502	30"
9503	36"
9504	48"

All thermocouples are furnished with universal adapters



GENERIC REPLACEMENT PARTS FOR PRICE- PFISTER® FAUCETS

Registered trade mark or trade name of Price Pfister. NOTE: Please do not confuse PASCO Specialty & Mfg., Inc. with this company. PASCO is an independent manufacturing redistributor of quality plumbing specialty products, which, although may not be manufactured by the original product manufacturer, are precision made.

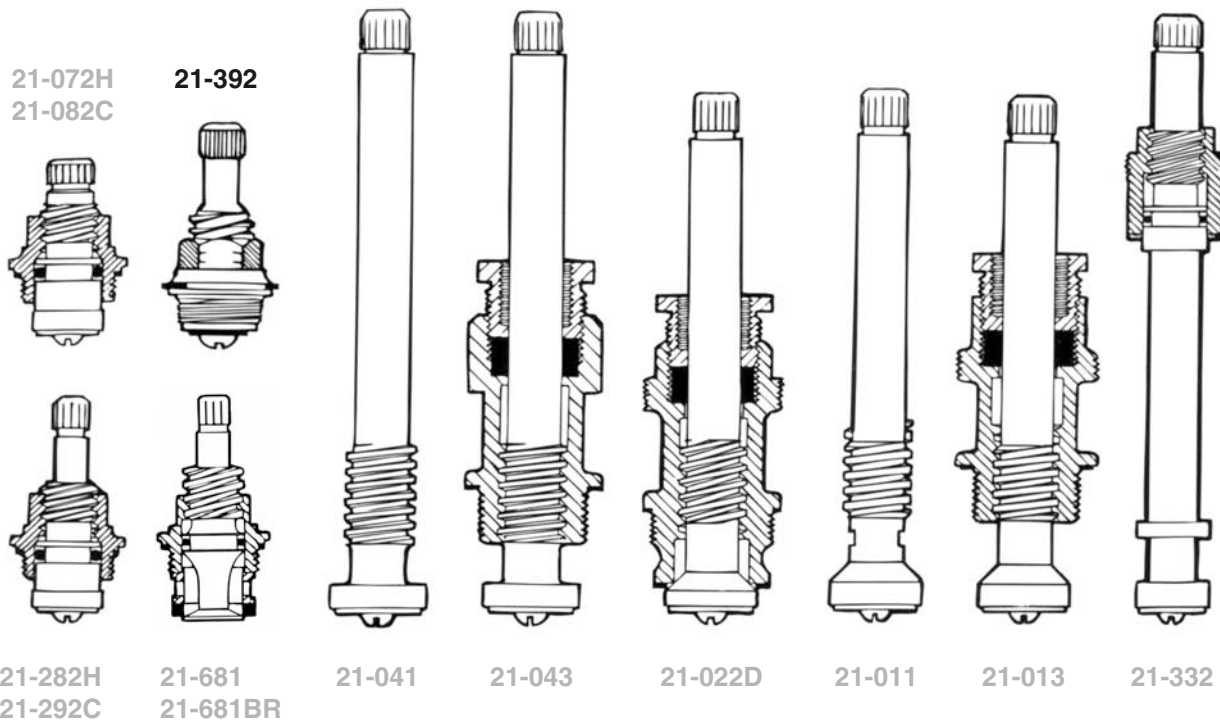

PART NUMBER	DESCRIPTION	FITS
21-072H	Stem, Hot, Lav	Basin Faucet-Crown Jewel, Crown Imperial, Shasta, Cascade, Laundry Tray
21-082C	Stem, Cold, Lav	
21-392	Stem, Hot/Cold, Kitchen & Lav	All Brass Contempera, Marquis, Verve
21-282H	Stem, Hot, Kitchen Faucet	Crown Jewel
21-292C	Stem, Cold, Kitchen Faucet	
21-041	Stem, Hot/Cold	2 & 3 Valve, Corner Valve, Washing Machine
21-043	Stem & Bonnet, Hot/Cold	Valve, Partition Stop, Beaux Art
21-022D	Diverter Stem & Bonnet, Hot/Cold	3 Valve, Crown Imperial, Lever Handles
21-013	Stem & Bonnet, Hot/Cold	2 & 3 Valve, Crown Imperial, Lever Handles
21-332	Bonnet & Stem, Widespread Lav Bidet Fittings	All Brass, Crown Imperial
21-681	Plastic washerless cartridge, Hot/Cold	All Lav/Kitchen deck units using
21-681BR	Brass washerless cartridge, Hot/Cold	washerless cartridge



GENERIC REPLACEMENT PARTS FOR PRICE- PFISTER® FAUCETS

Registered trade mark or trade name of Price Pfister. NOTE: Please do not confuse PASCO Specialty & Mfg., Inc. with this company. PASCO is an independent manufacturing redistributor of quality plumbing specialty products, which, although may not be manufactured by the original product manufacturer, are precision made.

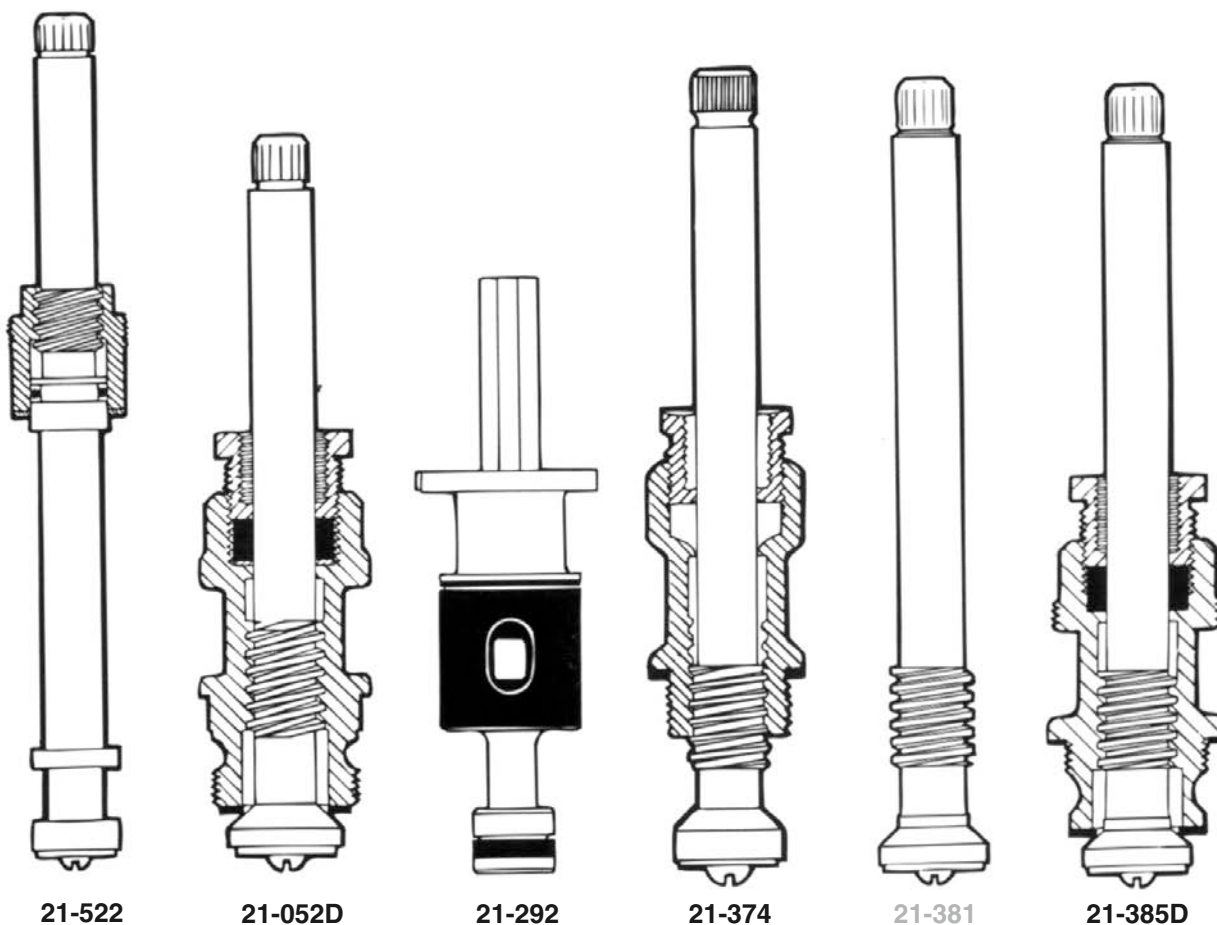

PART NUMBER	DESCRIPTION	FITS
21-522	Stem & Bonnet, Hot/Cold, Widespread Lav	Contempera, Contessa, Marquis, Verve
21-052D	Diverter Stem & Bonnet	2 & 3 Valve, Beaux Art
21-292	Avante Cartridge	All New Style Price Pfister Single Control Faucets & Valves
21-374	Stem & Bonnet, Hot/Cold	2 & 3 Valve, Washing Machine Valve, Contempera, Marquis, Verve, Windsor
21-381	Diverter Stem	Contempera, Marquis, Verve
21-385D	Diverter Stem & Bonnet	



GENERIC REPLACEMENT PARTS FOR PRICE- PFISTER® FAUCETS

Registered trade mark or trade name of Price Pfister. NOTE: Please do not confuse PASCO Specialty & Mfg., Inc. with this company. PASCO is an independent manufacturing redistributor of quality plumbing specialty products, which, although may not be manufactured by the original product manufacturer, are precision made.

21-020NP
21-020P
21-020GP

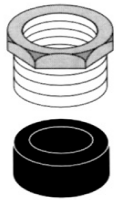

21-126



21-27

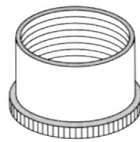

21-110EN



21-560
21-561

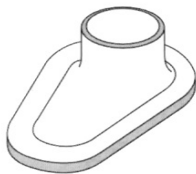
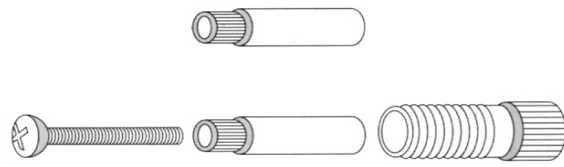

21-080A

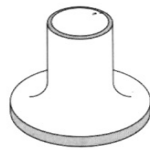

21-110A

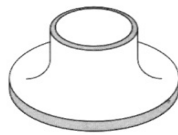

21-160A

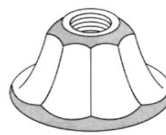

21-280



21-500

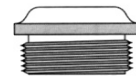

21-500C

PART NUMBER	DESCRIPTION	FITS
21-020NP	Bonnet Nut & Packing	2 & 3 Valve Stem, Crown Imperial, Beaux Art, Contempera, Contessa, Maruis, Verve & Windsor
21-020P	Packing ONLY, Rubber	
21-020GP	Packing ONLY, Graphite	
21-26	Tapered Escutcheon Nipple, All Brass	Most Shower Valves, Use With 21-27
21-27	Fit all Escutcheon Nipple Nut, CP Brass	Most Shower Flanges
21-110EN	Escutcheon Nipple, Nylon	All Price Pfister Tub & Shower Valves
21-560	1" Stem Extension	2 & 3 Valve Showers (Includes 2 Screws to Adapt to New & Old Style Handles)
21-561	Stem Extension Kit	
21-080A	Tear Drop Flange, CP	2 & 3 Valve W/ Integral Stops
21-110A	Shower Valve Flange, CP	2 & 3 Current Style Price Pfister Valves
21-160A	Widespread Flange, CP	Widespread Lav Faucets
21-280	Shower Valve, Hexagon Flange, CP	Old Style Price Pfister Valves
21-500	Seat, CP	2 & 3 Valve, Price Pfister
21-500C	Seat, CP, Lav	Kitchen & Lav Faucets, Price Pfister



GENERIC REPLACEMENT PARTS FOR PRICE- PFISTER® FAUCETS

Registered trade mark or trade name of Price Pfister. NOTE: Please do not confuse PASCO Specialty & Mfg., Inc. with this company. PASCO is an independent manufacturing redistributor of quality plumbing specialty products, which, although may not be manufactured by the original product manufacturer, are precision made.

21-510C
21-510D
21-510H
21-520C
21-520H



21-210C
21-220H



21-010B



21-020C
21-030H
21-040D
21-050C
21-060H



21-200C
21-200H

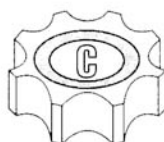

21-030B



21-090C
21-090H

21-270C
21-270H

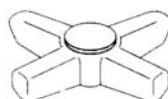

21-040B



21-740C
21-740D
21-740H
21-730C
21-730H

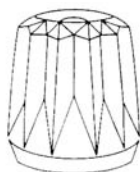

21-320
21-330
21-340

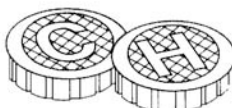

21-050B



PART NUMBER	DESCRIPTION
21-510C	Verve Handle, Cold
21-510D	Verve Lg. Handle, Diverter
21-510H	Verve Lg. Handle, Hot
21-520C	Verve Sm. Handle, Cold
21-520H	Verve Sm. Handle, Hot
21-020C	Contempera Lg. Handle, Cold
21-030H	Contempera Lg. Handle, Hot
21-040D	Contempera Lg. Handle, Diverter
21-050C	Contempera Sm. Handle, Cold
21-060H	Contempera Sm. Handle, Hot
21-090C	Marquis Lg. Handle, Cold
21-090H	Marquis Lg. Handle, Hot
21-740C	Windsor Lg. Handle, Cold
21-740D	Windsor Lg. Handle, Diverter
21-740H	Windsor Lg. Handle, Hot
21-730C	Windsor Sm. Handle, Cold
21-730H	Windsor Sm. Handle, Hot
21-210C	Crown Jewel Sm. Handle, Cold
21-220H	Crown Jewel Sm. Handle, Hot

PART NUMBER	DESCRIPTION
21-200C	Crown Imperial Widespread Handle, Cold
21-200H	Crown Imperial Widespread Handle, Hot
21-270C	Beaux Art Cross Handle, Cold
21-270H	Beaux Art Cross Handle, Hot
21-320	Verve Button, Cold
21-330	Verve Button, Hot
21-340	Verve Button, Diverter
21-010B	Diverter Stem Bonnet, 3 Valve, Diverter Stem, Beaux Art
21-030B	Shower Stem Bonnet 2 & 3 Valve, Beaux Art, Contempera, Marquis, Contessa, Verve & Windsor
21-040B	Diverter Stem Bonnet, 2 & 3 Valve, Crown Imperial
21-050B	Shower Stem Bonnet, 2 & 3 Valve, Crown Imperial



ICE MAKER HOOK - UP KITS

For use on refrigerators with automatic icemakers.
Also use on humidifiers.

Poly Tubing



KIT CONTAINS

- 1. 1/4" x 25' Poly tubing
- 1. Self-piercing needle valve
- 1. 1/4" Compression union
- 1. 1/4" 90° Compression coupling
- 4. 1/4" Brass insert sleeves
- 4. 1/4" Delrin insert sleeves
- 1. 1/4" Compression male

PART NUMBER	DESCRIPTION
2045	Hook - Up kit
2056-25	25' Poly tubing ONLY

Copper Tubing



KIT CONTAINS

- 1. 1/4" x 25' Copper Tubing
- 1. Self piercing needle value
- 1. 1/4" Compression union
- 1. 1/4" Compression male
- 1. 1/4" 90° Compression elbow

PART NUMBER	DESCRIPTION
2049	Copper hook up kit only
2059-25	25' Copper tubing ONLY

GRANULATED CARBON FILTER

Filters contain granulated carbon for taste and odor removal from municipal drinking water.

SPECIFICATIONS:

- Container - Polypropylene
- Media- Activated Carbon
- Filter/Screen - Polyestr Felt
- Micron Size - 20
- Flow Rate - 1 GPM @ 60 PSI
- Life Span - 3-6 months
- Effective Filterings - 2000 gal.
- Temp Rating - 120° F
- Pressure Rating - 125 PSI

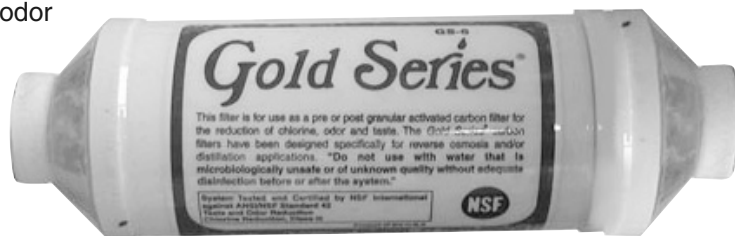

PART NUMBER	DESCRIPTION
2060	Use 1/4" Compression Fittings
2060-38	Use 3/8" Compression Fittings

SELF - PIERCING NEEDLE VALVE

For 3/8" To 1" Copper Tube

KIT CONTAINS:

- 1. Needle valve
- 1. Saddle clamp
- 2. Nuts
- 2. Bolts



PART NUMBER
2162