

HEATING PRODUCTS CATALOG



Westwood
by Beckett

Westwood by Beckett CAST IRON TOP FUEL FILTERS

WITH **EPOXY** COATING INSIDE!

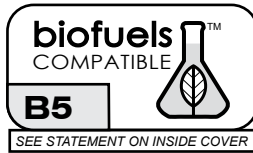

- Exact Replacement for popular CAST IRON top filters
- Heavy gauge canister with EPOXY COATING on the inside - FIRST in the industry!
- UL GPH and pressure ratings EXCEED comparable OEM filters
- 360° screwdriver slot makes disassembly for element changing easy
- Service environment: Indoors, 20° to 105° F



CHOICE OF ELEMENT INSIDE



F20

Pure/Oil™

Fiber-Welded White Element



F20

CLASSIC **FELT™**

Stacked Segment Element

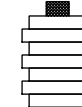

F25

CHOICE OF ELEMENT INSIDE



F65

Pure/Oil™

Fiber-Welded White Element

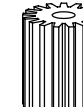

F65

CLASSIC **FELT™**

Stacked Segment Element



F70

COMPLETE CAST IRON TOP FILTERS with EPOXY coated canister

Item No.	Element Type	GPH	PSI	Exact Replacement for:
F20	Pure-Oil™	17	52	General 1A-25A
F25	CLASSIC FELT™			
F65	Pure-Oil™	32	52	General 2A-700A
F70	CLASSIC FELT™			

All filters have 3/8" NPT pipe connections

Westwood by Beckett

HIGH CAPACITY CAST IRON TOP FUEL FILTERS

WITH **EPOXY** COATING INSIDE!

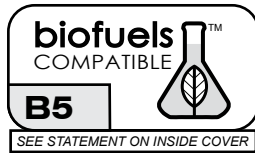

- Exact Replacement for popular CAST IRON top filters
- Heavy gauge canister with EPOXY COATING on the inside - FIRST in the industry!
- UL GPH and pressure ratings EXCEED comparable OEM filters
- 360° screwdriver slot makes disassembly for element changing easy
- **BIG GUY™** element holds twice as much as standard elements
- Service environment: Indoors, 20° to 105° F

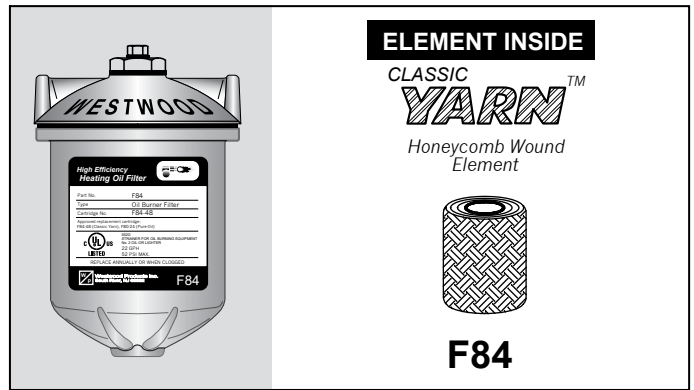
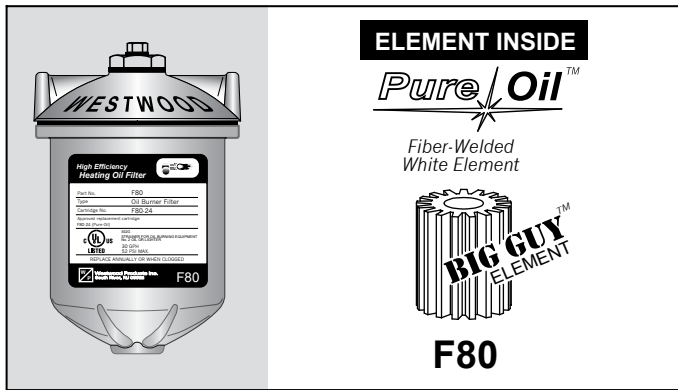

COMPLETE CAST IRON TOP FILTERS with EPOXY coated canister

BIG GUY™
ELEMENT
HOLDS TWICE AS MUCH!

Item No.	Element Type	GPH	PSI	Exact Replacement for:
F80	Pure-Oil™ BIG GUY™	30	52	Fulflo FB4
F84	CLASSIC YARN™	22	52	

All filters have 3/8" - NPT pipe connections



the NEW industry leader in Spin-Ons!

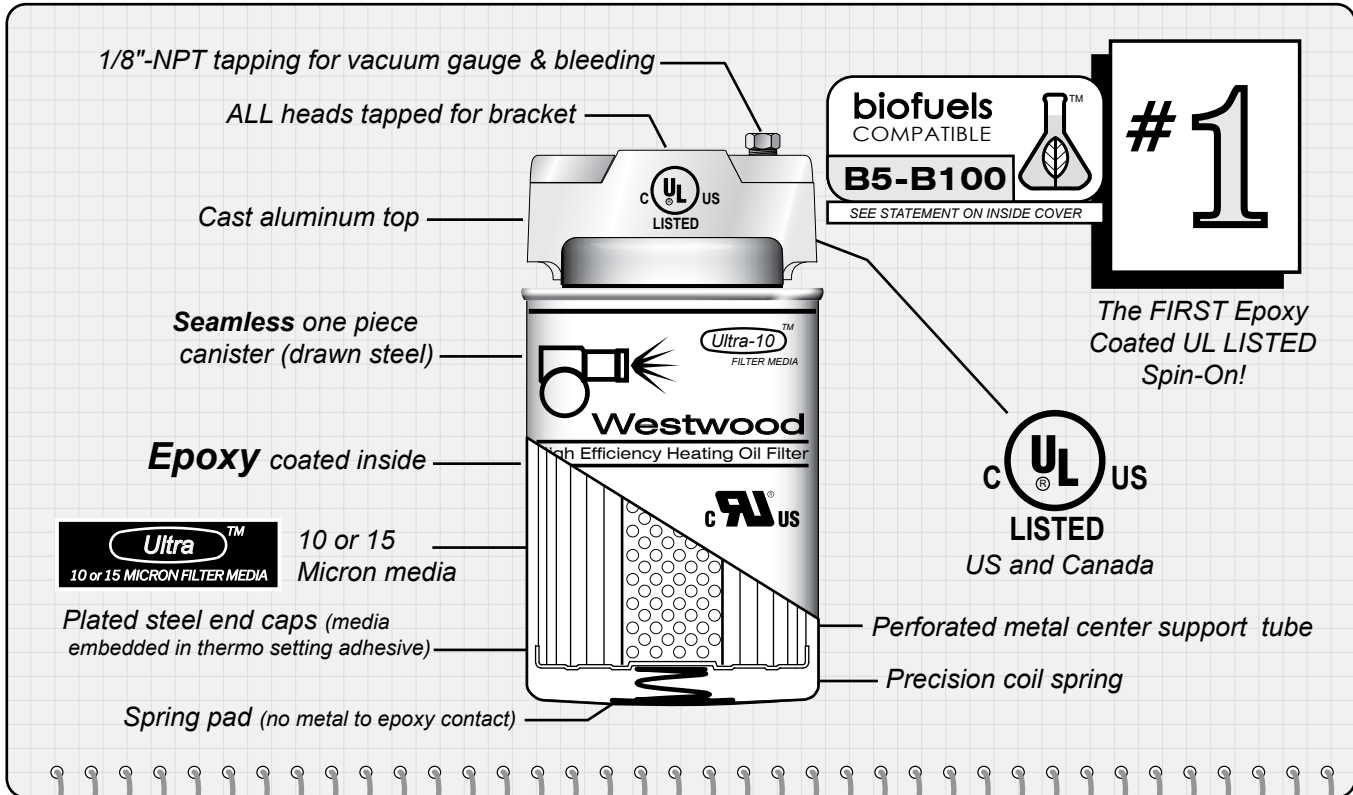

For Every Service Need...

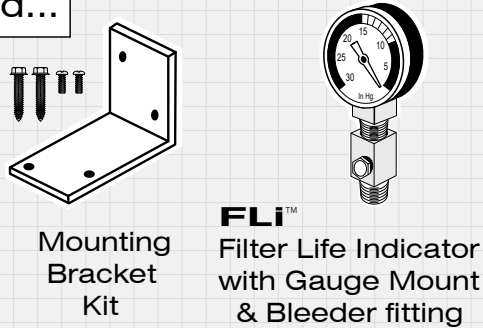
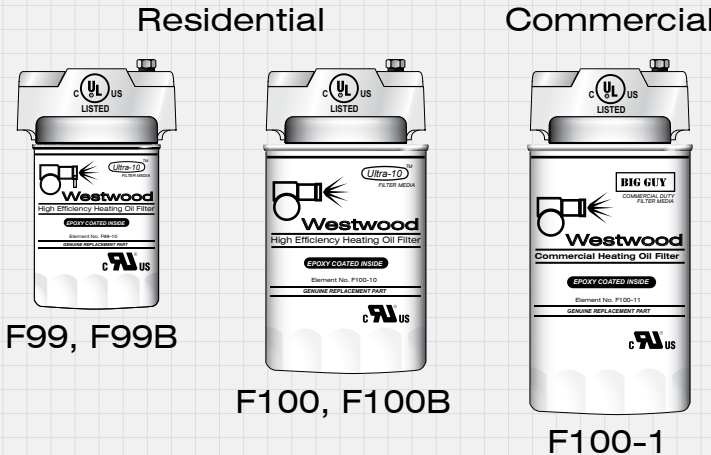

See the following pages for a complete listing of the entire Spin-On line, replacement elements, and accessories.

Item No.	F99	F99B	F100	F100B	F100-1
Microns	10	15	10	15	30
GPH	16	16	29	29	52
Fuel Oils	1, 2, up to B5	1, 2, up to B100	1, 2, up to B5	1, 2, up to B100	1, 2, up to B5

All Westwood Spin-On filters and replacement elements are either UL Listed or UL Recognized Components

THE NEW F99-2 SPIN-ON FILTER

Now The Perfect Size!

IF YOU LIKE
THIS FILTER...

...YOU'RE GONNA LOVE
THIS FILTER!



F20

- 17 GPH
- 52 PSI MAX
- UL Listed
- Epoxy Coated



F99-2

- 16 GPH
- 47 PSI MAX
- UL Listed
- Epoxy Coated
- 10 Micron Filtration
- Mounting Bracket
- Quick & Clean Filter Change
- Fits In Same Space As Traditional Filters

The New F99-2 Spin-on filter

Designed to match the size and performance of traditional oil burner filters, but with improvements that you will love! The F99-2 gives you 10 micron filtration, quick and clean filter changes, a mounting bracket, in a size that fits in the same space as traditional filters.

Item No	Description
F99-2	Complete Spin-on Filter w/mounting bracket
F99-10	Replacement Cartridge Only



F4

All Spin-On filters have 3/8"-NPT pipe connections and a 1/8"-NPT bleeder/gauge port. Service environment: Indoors, 20° to 105° F.

biofuels
COMPATIBLE

B5-B100



SEE STATEMENT ON INSIDE COVER

RESIDENTIAL - 16 GPH, 40 PSI, 10 or 15 Micron



Traditional F20

New!
F99-2
F99-2B

The New F99-2 & F99-2B Spin-on filters

Designed to match the size and performance of traditional oil burner filters, but with improvements that you will love! The F99-2 & F99-2B (biofuel) filters give you 10 & 15 micron filtration respectively. They offer quick and clean filter changes, a mounting bracket, in a size that fits in the same space as traditional filters.



F99-2
F99-2B
Complete Filter with bracket kit



F99-10
F99-10B
Replacement Element, indiv. boxed with "O" ring

Item No.	F99-2	F99-2B	F99-10	F99-10B
Microns	10	15	10	15
GPH	16	16	16	16
Fuel Oils	1, 2, up to B5	1, 2, up to B100	1, 2, up to B5	1, 2, up to B100

RESIDENTIAL - 29 GPH, 40 PSI, 10 or 15 Micron



F100
Complete Filter



F100-2
F100-2B
Complete Filter with bracket kit



F100-4
Complete Filter with bleeder fitting and **FLI**™ gauge



F100-6
Complete Filter with bracket kit, bleeder fitting and **FLI**™ gauge



F100-10
F100-10B
Replacement Element, individually boxed with "O" ring

Item No.	F100	F100-2	F100-2B	F100-4	F100-6	F100-10	F100-10B
Microns	10	10	15	10	10	10	15
GPH	29	29	29	29	29	29	29
Fuel Oils	1, 2, up to B5	1, 2, up to B5	1, 2, up to B100	1, 2, up to B5	1, 2, up to B5	1, 2, up to B5	1, 2, up to B100

COMMERCIAL - 52 GPH, 20 PSI, 30 Micron, Fuels 1, 2, B5

COMMERCIAL DUTY

30 MICRON FILTER MEDIA



F100-1
Complete Filter



F100-3
Complete Filter with bracket kit



F100-7
Complete Filter with bracket kit, bleeder fitting and **FLI**™ gauge



F100-11
Replacement Element, individually boxed with "O" ring





Need help identifying what you need? See cross reference on next page.

SPIN-ON CROSS REFERENCE - Westwood to others

Item No.	Description	Gar-Ber	Sid Harvey (Mitco)	Crown
F99-2	Filter - Residential	-	-	41439
F99-2B	Filter - Residential, w/bracket, 100% Biofuel	-	-	-
F100	Filter - Residential	11V-R	290, 264-SO	-
F100-1	Filter - Commercial	-	292-2, 264-92	-
F100-2	Filter - Residential w/bracket	11BV-R	-	-
F100-2B	Filter - Residential w/bracket, 100% Biofuel	-	-	-
F100-3	Filter - Commercial w/bracket	11BV-M	292-2B, 264-92B	-
F100-4	Filter - Residential w/gauge	11V-RK	-	-
F100-6	Filter - Residential w/bracket & gauge	11BV-RK	-	-
F100-7	Filter - Commercial w/bracket & gauge	11BV-MK	292-2GB, 264-92GB	-
F100-8	Replacement spin-on filter top only	-	290-SO, 290-SOM	-
F100-10	Spin-On element only - Residential	R	290-6, 264-91	41436
F100-10B	Spin-On element only - Residential, 100% Biofuel	-	-	-
F100-11	Spin-On element only - Commercial	M	292-1, 264-93	-
F100-14	Filter Life Indicator (FLI) color coded gauge, 1/8"-NPT	F.R.I.	-	-

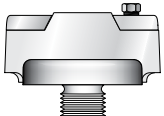
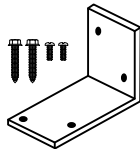
This cross-reference is provided as an aid in identifying which Westwood part numbers most closely replace those part numbers shown. It was accurate at the time it was created, to the extent that the information was publically available. Since manufacturers may sometimes change specs or discontinue products altogether, some inaccuracies may develop over time. Further, the Westwood parts shown will provide an equivalent, or superior, level of performance and service. However, due to differences among manufacturers, physical size and dimensions may vary.

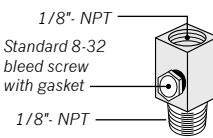
SPIN-ON PARTS & ACCESSORIES

 F100-8 3/8" INLETS F100-9 1/4" INLETS Replacement filter top only with holes for bracket	 F100-12 Mounting bracket Kit (includes screws)	 F100-14 FLI™ (Filter Life Indicator) color coded compound gauge	 1/8"- NPT Standard 8-32 bleed screw with gasket 1/8"- NPT F100-16 Gauge Mount with Bleeder Screw	 F100-18 Spin-On filter wrench (fits all popular filters)
---	--	--	--	--

FLI™ FILTER LIFE INDICATOR GAUGE AND FITTINGS

The **FLI™** gauge is a color coded compound gauge that predicts filter life by showing the running vacuum as the filter loads up. The fittings may also be used as a diagnostic tool wherever a gauge needs to be inserted into the system.



Item No.	Description	System Piping	Typically Installed At
F100-14	FLI™ Filter Life Indicator color coded gauge, 1/8"-NPT	-	-
F100-55	F100-50 fitting with FLI™ gauge	3/8" OD Copper	Pump, OSV, Tigerloop
F100-70	FLI™ fitting, 1/4"- NPT(F) x 1/4"- NPT(M)	Flexible Oil Line	Pump, OSV, Tigerloop

Pure Oil™ FILTER ELEMENTS

- ▶ Latest Computer Designed Shape
- ▶ Largest surface area with most filtering ribs
- ▶ Greater capacity - highest in it's class!
- ▶ Fiber-welded for shed free performance
- ▶ Environmentally friendly processed plant fiber
- ▶ Popular elements UL Recognized Components

The Most Advanced Design...
With the Most Advanced Material!

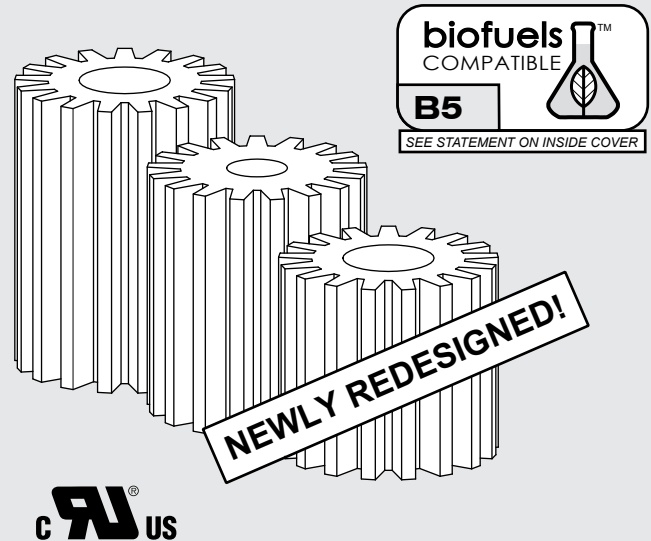

Item No.	Reference No.	Description	Fits	QTY PKG
F10-48*	PA-25	Pure-Oil™ Individually bagged with gaskets	General 1A-25A; Unifilter 77; Westwood F10, F12, F15, F20, F25; Sid Harvey (Mitco) 264, 264F	48
F30-24*	-	Pure-Oil™ Individually bagged with gaskets	General 2A-700A; Unifilter 99; Westwood F30, F32, F35, F65, F70; Sid Harvey (Mitco) 265, 265F	24
F80-24*	-	Pure-Oil™ BIG GUY™ Ind. bag w/gaskets	Fulflo FB4; Westwood F80, F84	24
F80-36*	P4FO-IB	Pure-Oil™ Individually boxed with gaskets	Fulflo FB4; Westwood F80, F84	36
F80-48*	-	Pure-Oil™ Individually bagged with gaskets	Fulflo FB4; Westwood F80, F84	48
F81-10	-	Pure-Oil™ Individually bagged with gaskets	Fulflo FB6	10
F82-6	-	Pure-Oil™ Individually bagged with gaskets	Fulflo FB8	6
F83-4	-	Pure-Oil™ Individually bagged with gaskets	Fulflo FB10	4
F92-6	-	Pure-Oil™ Individually bagged with gaskets	Purolator PF2002	6
F92-36	PP-20	Pure-Oil™ Individually bagged with gaskets	Purolator PF2002	36

* UL Recognized Component

CLASSIC
FELT™ STACKED SEGMENT ELEMENTS

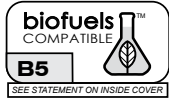

- ▶ Premium quality precision cut wool felt
- ▶ Economical time proven classic design
- ▶ UL Recognized Component

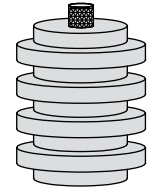
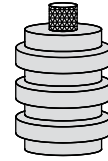

F15-36, -48

F35-12, -24

Item No.	Reference No.	Description	Fits	QTY PKG
F15-36*	A025	CLASSIC FELT™ Individ. boxed with gaskets	General 1A-25A; Unifilter 77; Westwood F10, F12, F15, F20, F25; Sid Harvey (Mitco) 264, 264F	36
F15-48*	A025B	CLASSIC FELT™ Individ. bagged with gaskets		48
F35-12*	-	CLASSIC FELT™ Individ. bagged with gaskets	General 2A-700A; Unifilter 99; Westwood F30, F32, F35, F65, F70; Sid Harvey (Mitco) 265, 265F	12
F35-24*	A070	CLASSIC FELT™ Individ. boxed with gaskets		24

* UL Recognized Component

CLASSIC
YARN™ WOUND ELEMENTS

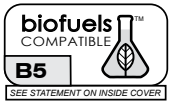

- ▶ Premium quality tightly wound yarn
- ▶ Economical time proven design
- ▶ Popular elements UL Recognized

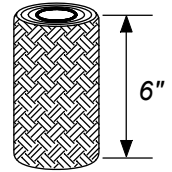
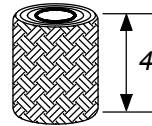

F84 (SERIES)
for Fulflo FB4;
Westwood F80, F84

F85 (SERIES)
for Fulflo FB6

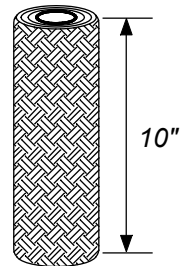
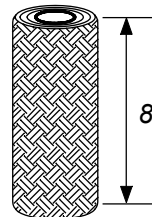

F86 (SERIES)
for Fulflo FB8

F87 (SERIES)
for Fulflo FB10

Item No.	Reference No.	Description	Fits	QTY PKG
F84-30PK	4FO-30	Bulk, NO gaskets	Fulflo FB4	30
F84-36*	4FO-IB	Boxed with gaskets	Westwood	36
F84-48*	4FO-IBG	Bagged with gaskets	F80, F84	48
F85-10	-	Bagged with gaskets	Fulflo FB6	10
F86-6	-	Bagged with gaskets	Fulflo FB8	6
F86-30	8FO-30	Bulk (no gaskets)		30
F87-4	-	Bagged with gaskets	Fulflo FB10	4
F87-30	10FO-30	Bulk (no gaskets)		30

* UL Recognized Component



USE ONLY

UL RECOGNIZED

replacement canisters

Another industry first! Westwood's new line of replacement canisters are UL Recognized for use on General 1A-25A, 2A-700A; Unifilter 77, Unifilter 99; Sid Harvey (Mitco) 264, 264F, 265, 265F; and Fulflo FB4.

Be Safe! Always look for the UL Recognized Component symbol



CANISTER UPGRADE KITS*

Epoxy coated canister, element, center bolt, gasket, fiber washers
 Service environment: Indoors, 20° to 105° F

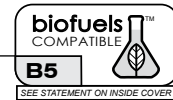

Item No.	Element Type	Upgrades
F10-5	Pure-Oil™	General 1A-25A; Unifilter 77; Westwood F10, F12, F15, F20, F25; Sid Harvey (Mitco) 264, 264F
F30-5	Pure-Oil™	General 2A-700A; Unifilter 99; Westwood F30, F32, F35, F65, F70; Sid Harvey (Mitco) 265, 265F
F80-5	Pure-Oil™ BIG GUY™	FULFLO FB4; Westwood F80, F84

* All kits contain UL Recognized Component canisters and elements

Westwood

by Beckett®



Limited Warranty Information

Scan QR or visit beckettcorp.com/support/warranty/ for the most up-to-date warranty information on Westwood Products

USA: R.W. Beckett Corporation, 1-800-645-2876

Canada: R.W. Beckett Canada Ltd, 1-800-665-6972

www.beckettcorp.com

Printed in the USA 1/23 Form No. 62311

This document and all information contained herein are the sole property of the R.W. Beckett Corporation and cannot be reproduced or transmitted in whole or part without express written permission of the R.W. Beckett Corporation.
©R.W. Beckett 12/2022