



John Guest[®]

The Push-fit People

Fluid System Products



INCLUDES NEW

- Fittings
- Valves
- Service Kits

USA Catalog
March 2015



The John Guest Group has a long established reputation as a world leading manufacturer of push-in fittings, tube and other fluid control products. A reputation built on producing consistently high quality products with an ongoing commitment to value engineering and product development.



Quality Manufacture

Both design and manufacture are carried out in John Guest's modern, purpose-built facilities in the United Kingdom.

Maintaining control over the entire process - from initial tool design and tool-making to final assembly and testing - ensures that only products of the highest quality are produced.

It is this commitment to quality that has resulted in the Company receiving prestigious awards from many of the world's leading testing and approvals organizations.

John Guest is a preferred supplier to many international companies.



FLUID SYSTEM PRODUCTS



John Guest's Standard line of Push-In Fittings, Shut-off Valves, and Polyethylene Tubing has been designed for use with a wide range of industrial water treatment applications involving Water Purification, Reverse Osmosis, Ice Makers, Beverage Dispensing, Vending & OCS, R.V. and Marine, Car Washing Systems and many more.

The fittings are simple to use and require no tools to make reliable, leak-free connections.

Standard Push-In Fittings, Shut-Off Valves, and Polyethylene Tubing are produced from FDA compliant materials and are listed with NSF International Standards 51 and 61.

<p>POLYPROPYLENE FITTINGS</p> <p>p5-6</p>		<p>INCH ACETAL SHUT-OFF VALVES CHECK VALVES</p> <p>p21</p>	
<p>SERVICE AND REPAIR KITS</p> <p>NEW p7</p>		<p>ACETAL SHUT-OFF AND BY-PASS VALVES</p> <p>p21</p>	
<p>BLACK POLYPROPYLENE FITTINGS & VALVES</p> <p>NEW p8</p>		<p>BRASS FITTINGS/ METRIC TO INCH FITTING</p> <p>p22</p>	
<p>ACETAL FITTINGS</p> <p>p9-12</p>		<p>LLDPE TUBE</p> <p>p23-24</p>	
<p>WHITE ACETAL FITTINGS</p> <p>p13</p>		<p>ACCESSORIES</p> <p>p25</p>	
<p>SUPERSEAL FITTINGS</p> <p>p14</p>		<p>PLASTIC HALF CARTRIDGES METAL HALF CARTRIDGES</p> <p>p26-29</p>	
<p>METRIC POLYPROPYLENE FITTINGS</p> <p>p15</p>		<p>PI TO PP CROSS REFERENCE CHART</p> <p>p30</p>	
<p>METRIC/INCH ACETAL FITTINGS</p> <p>p16-18</p>		<p>TECHNICAL SPECIFICATIONS (PI, SI, SM AND PM)</p> <p>p31</p>	
<p>ICE MAKER/WATER SUPPLY KIT</p> <p>p19</p>		<p>WHITE CTS JG TWIST & LOCK® FITTINGS LEAD FREE BRASS FITTINGS FEMALE SWIVEL ELBOW</p> <p>NEW p32-33</p>	
<p>INCH POLYPROPYLENE ANGLE STOP ADAPTER VALVES</p> <p>p19</p>		<p>BLACK CTS JG TWIST & LOCK® FITTINGS AND SHUT-OFF VALVES</p> <p>NEW p34</p>	
<p>INCH POLYPROPYLENE ANGLE STOP ADAPTER VALVES</p> <p>p20</p>		<p>FLEXI HOSES</p> <p>NEW p35</p>	
<p>INCH POLYPROPYLENE SHUT-OFF VALVES</p> <p>p20</p>		<p>CTS TECHNICAL CHECKLIST (PEI, PSEI)</p> <p>p36</p>	
<p>ACETAL ANGLE STOP VALVES</p> <p>NEW p21</p>		<p>TERMS AND CONDITIONS</p> <p>p37-38</p>	

How to make a Standard Connection

MAKING A GOOD CONNECTION:

To make a connection, the tube is simply pushed in by hand; the unique patented John Guest collet locking system then holds the tube firmly in place without deforming it or restricting flow.

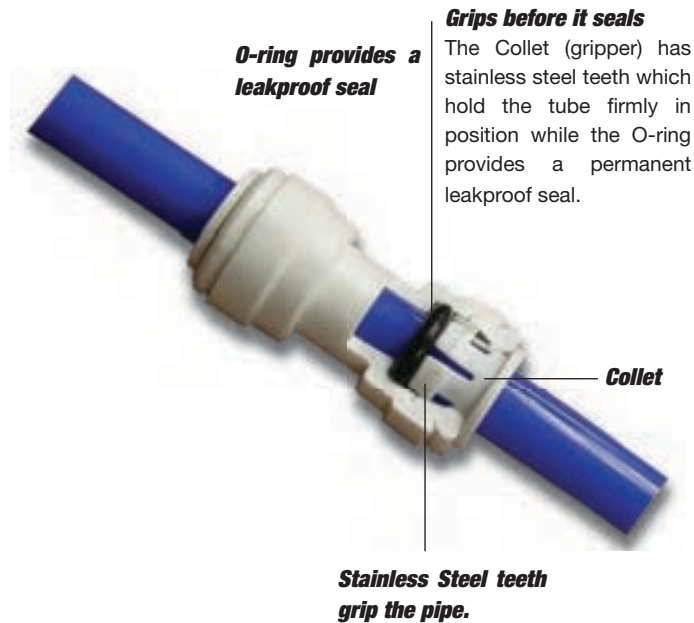

CUT THE TUBE SQUARE



Cut the tube square and remove burrs and sharp edges. Ensure that the outside diameter is free from score marks. For soft or thin-walled plastic tubing we recommend the use of a tube insert.

PUSH UP TO TUBE STOP



Push the tube into the fitting and up to the tube stop.

PULL TO CHECK SECURE



Pull on the tube to check that it is secure.
Test the system before use.

TO DISCONNECT Push in collet and remove tube



To disconnect, ensure that the system is depressurized, push the collet square against the fitting. With the collet held in this position the tube can be removed.



Inch Polypropylene Fittings

The PP Range of inch-size push-in fittings is offered for tube sizes 1/4" O.D. to 1/2" O.D. The fittings are manufactured in white polypropylene with food grade EPDM O-rings. They have been developed to satisfy the filtered pure water market and wide range of applications.

The PP Range is NOT suitable for compressed air applications. For these situations we recommend the PI Range on pages 9-12.

Working Pressures and Temperatures

Water	Max.	150 psi at 70°F	(Max. 10 Bar at 20°C)
	Max.	60 psi at 140°F	(Max. 4 Bar at 60°C)
	Min.	33°F/1°C	

Detailed technical information is shown on page 30.

Prices are subject to change without notice.



MALE CONNECTOR NPTF THREAD



PART NO.	TUBE OD	THREAD NPTF	BAG QTY	BOX QTY
PP010821W	1/4	- 1/8	10	500
PP010822W	1/4	- 1/4	10	400
PP010823W	1/4	- 3/8	10	400
PP011222W	3/8	- 1/4	10	250
PP011223W	3/8	- 3/8	10	250
PP011224W	3/8	- 1/2	10	250
PP011623W	1/2	- 3/8	10	150
PP011624W	1/2	- 1/2	10	150

UNION CONNECTOR



PART NO.	TUBE OD	BAG QTY	BOX QTY
PP0408W	1/4	10	400
PPM0408W	5/16	10	300
PP0412W	3/8	10	200
PP0416W	1/2	10	100

PLUG



PART NO.	STEM OD	BAG QTY	BOX QTY
PP0808W	1/4	10	500
PPM0808W	5/16	10	500
PP0812W	3/8	10	400
PP0816W	1/2	10	300

UNION TEE



PART NO.	TUBE OD	BAG QTY	BOX QTY
PP0208W	1/4	10	300
PPM0208W	5/16	10	200
PP0212W	3/8	10	100
PP0216W	1/2	10	80
Blue Collet			
PP0208W-B	1/4	10	300

STEM ADAPTER NPTF THREAD



PART NO.	STEM OD	THREAD NPTF	BAG QTY	BOX QTY
PP050821W	1/4	x 1/8	10	500
PP050822W	1/4	x 1/4	10	500
PP051222W	3/8	x 1/4	10	300
PP051223W	3/8	x 3/8	10	200
PP051623W	1/2	x 3/8	10	250
PP051624W	1/2	x 1/2	10	200

SWIVEL ELBOW NPTF THREAD



PART NO.	TUBE OD	THREAD NPTF	BAG QTY	BOX QTY
PP090821W	1/4	x 1/8	10	300
PP090822W	1/4	x 1/4	10	200
PP091222W	3/8	x 1/4	10	100
PP091223W	3/8	x 3/8	10	100

UNION ELBOW



PART NO.	TUBE OD	BAG QTY	BOX QTY
PP0308W	1/4	10	400
PPM0308W	5/16	10	300
PP0312W	3/8	10	200
PP0316W	1/2	10	100
Blue Collet			
PP0308W-B	1/4	10	400

REDUCER



PART NO.	STEM OD	TUBE OD	BAG QTY	BOX QTY
PP061208W	3/8	- 1/4	10	400
PP061210W	3/8	- 5/16	10	400
PP061612W	1/2	- 3/8	10	200
PP062008W	5/8	- 1/4	10	200
PP062012W	5/8	- 3/8	10	200
PP062016W	5/8	- 1/2	10	150

SWIVEL BRANCH TEE CENTER LEG NPTF THREAD



PART NO.	TUBE OD	THREAD NPTF	BAG QTY	BOX QTY
PP100821W	1/4	x 1/8	10	200
PP100822W	1/4	x 1/4	10	200
PP101222W	3/8	x 1/4	10	100
PP101223W	3/8	x 3/8	10	100

SWIVEL MALE RUN TEE NPTF THREAD



PART NO.	TUBE OD	THREAD NPTF	BAG QTY	BOX QTY
PP110821W	1/4	x 1/8	10	200
PP110822W	1/4	x 1/4	10	200
PP111222W	3/8	x 1/4	10	100
PP111223W	3/8	x 3/8	10	100

BULKHEAD UNION



PART NO.	TUBE OD	Mounting Hole Dia.	BAG QTY	BOX QTY
PP1208W	1/4	0.67	10	200
PP1212W	3/8	0.83	10	100
PP1216W	1/2	1.06	5	50

Polypropylene Bulkhead Unions are not intended for submerged use.

REDUCING BULKHEAD UNION



PART NO.	TUBE OD	TUBE OD	Mounting Hole Dia.	BAG QTY	BOX QTY
PP121208W	3/8	- 1/4	0.83	10	150

Polypropylene Bulkhead Unions are not intended for submerged use.

REDUCING UNION CONNECTOR



PART NO.	TUBE OD	TUBE OD	BAG QTY	BOX QTY
PP201208W	3/8	- 1/4	10	250
PP201612W	1/2	- 3/8	10	150

REDUCING ELBOW



PART NO.	TUBE OD	TUBE OD	BAG QTY	BOX QTY
PP211008W	5/16	- 1/4	10	300
PP211208W	3/8	- 1/4	10	200
PP211612W	1/2	- 3/8	10	150

PLUG IN ELBOW

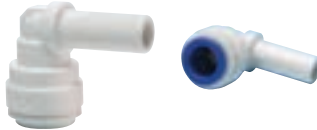

PART NO.	STEM OD	TUBE OD	BAG QTY	BOX QTY
PP220808W	1/4	- 1/4	10	500
PPM220808W	5/16	- 5/16	10	400
PP221208W	3/8	- 1/4	10	300
PP221212W	3/8	- 3/8	10	200
PP221616W	1/2	- 1/2	10	150
Blue Collet				
PP221212W-B	3/8	- 3/8	10	200

TWO WAY DIVIDER



PART NO.	TUBE OD	BAG QTY	BOX QTY
PP2312W	3/8	10	150

UNEQUAL TWO WAY DIVIDER



PART NO.	TUBE OD INLET	TUBE OD OUTLET	BAG QTY	BOX QTY
PP241208W	3/8	x 1/4	10	200

TUBE TO HOSE STEM



PART NO.	STEM OD	HOSE ID	BAG QTY	BOX QTY
PP251212W	3/8	- 3/8	10	400
PP251216W	3/8	- 1/2	10	300
PP251612W	1/2	- 3/8	10	300
PP251616W	1/2	- 1/2	10	250

REDUCING TEE



PART NO.	TUBE OD END	TUBE OD END	TUBE OD BRANCH	BAG QTY	BOX QTY
PP30080812W	1/4	x 1/4	x 3/8	10	150
PP30120812W	3/8	x 1/4	x 3/8	10	150
PP30121208W	3/8	x 3/8	x 1/4	10	150
PP301612W	1/2	x 1/2	x 3/8	10	50

FIXED TEE ADAPTER



PART NO.	TUBE OD END	TUBE OD END	NPTF BRANCH	BAG QTY	BOX QTY
PP641223W	3/8	x 3/8	x 3/8	10	150

FAUCET CONNECTOR UNS THREAD



PART NO.	TUBE OD	THREAD UNS	BAG QTY	BOX QTY
PP3208U7W	1/4	x 7/16 - 24	10	400
PP3212U7W	3/8	x 7/16 - 24	10	300

7/16 - 24 UNS = 1/4 Compression Threads

FEMALE ADAPTER NPTF THREAD



PART NO.	TUBE OD	THREAD NPTF	BAG QTY	BOX QTY
PP450821W	1/4	x 1/8	10	400
PP450822W	1/4	x 1/4	10	200
PP451222W	3/8	x 1/4	10	200
PP451223W	3/8	x 3/8	10	150

FIXED ELBOW NPTF THREAD



PART NO.	TUBE OD	THREAD NPTF	BAG QTY	BOX QTY
PP480821W	1/4	x 1/8	10	500
PP480822W	1/4	x 1/4	10	400
PP480823W	1/4	x 3/8	10	300
PP481222W	3/8	x 1/4	10	200
PP481223W	3/8	x 3/8	10	200

THREE WAY DIVIDER



PART NO.	TUBE OD INLET	TUBE OD OUTLET	BAG QTY	BOX QTY
PP491208W	3/8	x 1/4	150	150

STACKABLE TEE CONNECTOR



PART NO.	TUBE OD INLET	STEM OD	TUBE OD OUTLET	BAG QTY	BOX QTY
PP531212W	3/8	x 3/8	x 3/8	10	150

ACCESSORIES FOR PP FITTINGS ARE SHOWN ON PAGE 25.



Service and Repair Kits

The John Guest Service and Repair Kit includes various configurations of our most popular fittings in 1/4", 3/8" and 1/2" PP Range. Fittings come in a sturdy and compartmentalized case for ease of storage and transportation.

The PP Range is NOT suitable for compressed air applications. For these situations we recommend the PI Range on pages 9-12.

Working Pressures and Temperatures

Water	Max.	150 psi at 70°F	(Max. 10 Bar at 20°C)
	Max.	60 psi at 140°F	(Max. 4 Bar at 60°C)
	Min.	33°F/1°C	

Detailed technical information is shown on page 30.

Prices are subject to change without notice.



PART NO.

KIT-ISRK

KIT INCLUDES:

PART NO.	DESCRIPTION	QTY
PP010822W	1/4 X 1/4 MALE CONNECTOR	5
PP011222W	3/8 X 1/4 MALE CONNECTOR	5
PP011223W	3/8 X 3/8 MALE CONNECTOR	5
PP0208W	1/4 TEE	5
PP0212W	3/8 TEE	5
PP0308W	1/4 ELBOW	5
PP0312W	3/8 ELBOW	5
PP0408W	1/4 UNION	5
PP0412W	3/8 UNION	5
PP061208W	3/8 - 1/4 REDUCER	5
PP201208W	3/8 - 1/4 REDUCING UNION	5
PP220808W	1/4 X 1/4 PLUG-IN ELBOW	5
PP221212W	3/8 X 3/8 PLUG-IN ELBOW	5
PP3208U7W	1/4 X 1/4 FEMALE CONNECTOR	5
PP3212U7W	3/8 X 1/4 FEMALE CONNECTOR	5
PP480822W	1/4 X 1/4 NPTF FIXED ELBOW	5
PP481223W	3/8 X 3/8 NPTF FIXED ELBOW	5
PPSV040808WP	1/4 X 1/4 SHUT-OFF VALVE	3
ASVPP1LF	3/8 X 3/8 - 1/4 ANGLE STOP VALVE	2
ASVPP5LF	1/2 X 3/8 - 1/4 ANGLE STOP VALVE	1

PART NO.

KIT-ISRKE

KIT INCLUDES:

PART NO.	DESCRIPTION	QTY
PP010822E	1/4 x 1/4 NPT MALE CONNECTOR, BLK POLYPRO	5
PP010823E	1/4 x 3/8 NPT MALE CONNECTOR, BLK POLYPRO	5
PP011222E	3/8 x 1/4 NPT MALE CONNECTOR, BLK POLYPRO	5
PP011223E	3/8 x 3/8 NPT MALE CONNECTOR, BLK POLYPRO	5
PP0208E	1/4 UNION TEE, BLACK POLYPROPYLENE	5
PP0212E	3/8 UNION TEE, BLACK POLYPROPYLENE	5
PP0308E	1/4 UNION ELBOW, BLACK POLYPROPYLENE	5
PP0312E	3/8 UNION ELBOW, BLACK POLYPROPYLENE	5
PP0408E	1/4 UNION CONNECTOR, BLACK POLYPROPYLENE	5
PP0412E	3/8 UNION CONNECTOR, BLACK POLYPROPYLENE	5
PP050822E	1/4 x 1/4 NPT STEM ADAPTER, BLK POLYPRO	5
PP051223E	3/8 x 3/8 NPTF STEM ADAPTER, BLACK	5
PP201208E	3/8-1/4 REDUCING UNION CONNECTOR, BLK POLYPRO	5
PP201612E	1/2-3/8 REDUCING UNION CONNECTOR, BLK POLYPRO	5
PP220808E	1/4 - 1/4 PLUG IN ELBOW, BLACK POLYPROPYLENE	5
PP221212E	3/8 - 3/8 PLUG IN ELBOW, BLACK POLYPROPYLENE	5
PP450822E	1/4 x 1/4 NPT FEMALE ADAPTER, BLK POLYPRO	5
PP480822E	1/4 x 1/4 NPT FIXED ELBOW, BLK POLYPROPYLENE	5
PP481222E	3/8 x 1/4 NPT FIXED ELBOW, BLK POLYPROPYLENE	5
PP481223E	3/8 x 3/8 NPT FIXED ELBOW, BLK POLYPROPYLENE	5
TSNIP	TUBE CUTTER	1



Inch Polypropylene Fittings

The PP Range of Black Polypropylene Fittings has been developed to satisfy the needs of the Water Purification and Beverage Dispensing Markets. Black Polypropylene Fittings are U.V. stabilized and are ideal for use in Agricultural Spraying, Car Wash Chemical Dispense, Farm Machinery and Dairy Equipment applications.

Detailed technical information is shown on page 31.

Not suitable for compressed air applications.

Prices are subject to change without notice.

MALE CONNECTOR

NPTF THREAD



PART NO.	TUBE OD	THREAD NPTF	BAG QTY	BOX QTY
PP010821E	1/4	- 1/8	10	500
PP010822E	1/4	- 1/4	10	400
PP010823E	1/4	- 3/8	10	400
PP011222E	3/8	- 1/4	10	250
PP011223E	3/8	- 3/8	10	250
PP011224E	3/8	- 1/2	10	250

STEM ADAPTER

NPTF THREAD



PART NO.	STEM OD	THREAD NPTF	BAG QTY	BOX QTY
PP050821E	1/4	- 1/8	10	500
PP050822E	1/4	- 1/4	10	500
PP051223E	3/8	- 3/8	10	200

FIXED ELBOW

NPTF THREAD



PART NO.	TUBE OD	THREAD NPTF	BAG QTY	BOX QTY
PP480821E	1/4	- 1/8	10	500
PP480822E	1/4	- 1/4	10	400
PP480823E	1/4	- 3/8	10	300
PP481222E	3/8	- 1/4	10	200
PP481223E	3/8	- 3/8	10	200

UNION TEE



PART NO.	TUBE OD	BAG QTY	BOX QTY
PP0208E	1/4	10	300
PPM0208E	5/16	10	200
PP0212E	3/8	10	100

BULKHEAD UNION



PART NO.	TUBE OD	MOUNTING HOLE DIA.	BOX QTY	BOX QTY
PP1208E	1/4	0.67	10	200
PP1212E	3/8	0.83	10	100

FEMALE ADAPTER

NPTF THREAD



PART NO.	TUBE OD	THREAD NPTF	BAG QTY	BOX QTY
PP450821E	1/4	- 1/8	10	400
PP450822E	1/4	- 1/4	10	200

UNION ELBOW



PART NO.	TUBE OD	BAG QTY	BOX QTY
PP0308E	1/4	10	400
PP0312E	3/8	10	200

REDUCING UNION CONNECTOR



PART NO.	TUBE OD	TUBE OD	BAG QTY	BOX QTY
PP201208E	3/8	- 1/4	10	250
PP201612E	1/2	- 3/8	10	150



STRAIGHT SHUT-OFF VALVE

SPEEDFIT TO SPEEDFIT



PART NO.	TUBE OD	BAG QTY	BOX QTY
PPSV040808E	1/4	10	200
PPSV041212E	3/8	10	80

PLUG IN ELBOW



PART NO.	STEM OD	TUBE OD	BAG QTY	BOX QTY
PP220808E	1/4	- 1/4	10	500
PP221212E	3/8	- 3/8	10	200



SHUT-OFF VALVE

SPEEDFIT TO FEMALE



PART NO.	TUBE OD	THREAD NPTF	BAG QTY	BOX QTY
PPSV451223E	3/8	- 3/8	10	-

UNION CONNECTOR



PART NO.	TUBE OD	BAG QTY	BOX QTY
PP0408E	1/4	10	400
PPM0408E	5/16	10	300
PP0412E	3/8	10	200

TWO WAY DIVIDER



PART NO.	TUBE OD	BAG QTY	BOX QTY
PP2308E	1/4	10	150



BLACK LLDPE COIL



PART NO.	COIL OD	LENGTH	BAG QTY	BOX QTY
PE-08-BI-025F-E	1/4"	25'	1	20
PE-08-BI-0500F-E	1/4"	500'	-	2
PE-08-BI-1000F-E	1/4"	1000'	-	1



The PI Range of inch-size push-in fittings is offered for tube sizes 5/32" O.D. to 5/8" O.D. The fittings are manufactured in gray acetal copolymer with food grade nitrile O-ring, making them especially suitable for applications involving foodstuff and potable liquids. They are also suitable for air and inert gases and can therefore be used on CO₂ lines, pneumatic applications and vacuum.

Detailed technical information is shown on page 31.

Prices are subject to change without notice.



MALE CONNECTOR NPTF THREAD



PART NO.	TUBE OD	THREAD NPTF	BAG QTY	BOX QTY
PM010421S	5/32 x 1/8		10	500
PM010422S	5/32 x 1/4		10	500
PI010621S	3/16 x 1/8		10	500
PI010821S	1/4 x 1/8		10	500
PI010822S	1/4 x 1/4		10	400
PI010823S	1/4 x 3/8		10	300
PM010821S	5/16 x 1/8		10	400
PM010822S	5/16 x 1/4		10	400
PM010823S	5/16 x 3/8		10	300
PI011221S	3/8 x 1/8		10	250
PI011222S	3/8 x 1/4		10	250
PI011223S	3/8 x 3/8		10	250
PI011224S	3/8 x 1/2		10	200
PI011623S	1/2 x 3/8		10	150
PI011624S	1/2 x 1/2		10	150
PI012026S	5/8 x 3/4		10	100

MALE CONNECTOR BSPT THREAD



PART NO.	TUBE OD	THREAD BSPT	BAG QTY	BOX QTY
PM010401S	5/32 x 1/8		10	500
PM010402S	5/32 x 1/4		10	500
PI010601S	3/16 x 1/8		10	500
PI010602S	3/16 x 1/4		10	500
PI010801S	1/4 x 1/8		10	500
PI010802S	1/4 x 1/4		10	400
PM010801S	5/16 x 1/8		10	400
PM010802S	5/16 x 1/4		10	400
PM010803S	5/16 x 3/8		10	300
PI011202S	3/8 x 1/4		10	250
PI011203S	3/8 x 3/8		10	250
PI011603S	1/2 x 3/8		10	150
PI011604S	1/2 x 1/2		10	150

MALE CONNECTOR BSPP THREAD



PART NO.	TUBE OD	THREAD BSPP	BAG QTY	BOX QTY
PI010812S	1/4 x 1/4		10	250
PI011212S	3/8 x 1/4		10	250
PI011213S	3/8 x 3/8		10	250

MALE CONNECTOR BSPP THREAD



PART NO.	TUBE OD	THREAD BSPP	BAG QTY	BOX QTY
NCPI011211S	3/8 x 1/8		10	200
NCPI011212S	3/8 x 1/4		10	250

3/8" x 1/4" has special large seal for use with chamfered face ports.

No thread seal on 3/8" x 1/8".

FLARE MALE CONNECTOR MFL THREAD



45° FLARE

PART NO.	TUBE OD	THREAD MFL	BAG QTY	BOX QTY
PI0108F4S	1/4 x	1/4	10	300
PM0108F5S	5/16 x	5/16	10	500
PI0112F4S	3/8 x	1/4	10	250
PI0112F5S	3/8 x	5/16	10	250
PI0112F6S	3/8 x	3/8	10	300
PI0112F8S	3/8 x	1/2	10	200
PI0116F8S	1/2 x	1/2	10	200
PM0108C5S	5/16 x	1/2 - 16UN	10	400
PI0112C5S	3/8 x	1/2 - 16UN	10	200

1/4" (MFL) corresponds to a 7/16-20 UNF
 5/16" (MFL) corresponds to a 1/2-20 UNF
 3/8" (MFL) corresponds to a 5/8-18 UNF
 1/2" (MFL) corresponds to a 3/4-16 UNF

OUTLET ADAPTER BSPP THREAD



PART NO.	TUBE OD	THREAD BSPP	BAG QTY	BOX QTY
NC128/112	3/8 x 1/4		10	200

UNION TEE



PART NO.	TUBE OD	BAG QTY	BOX QTY
PM0204S	5/32	10	400
PI0206S	3/16	10	400
PI0208S	1/4	10	300
PM0208S	5/16	10	200
PI0212S	3/8	10	100
PI0216S	1/2	10	50

UNION ELBOW



PART NO.	TUBE OD	BAG QTY	BOX QTY
PM0304S	5/32	10	500
PI0306S	3/16	10	500
PI0308S	1/4	10	400
PM0308S	5/16	10	300
PI0312S	3/8	10	200
PI0316S	1/2	10	100
Blue Collet PI0308S-B	1/4	10	400

UNION CONNECTOR



PART NO.	TUBE OD	BAG QTY	BOX QTY
PM0404S	5/32	10	500
PI0406S	3/16	10	500
PI0408S	1/4	10	400
PM0408S	5/16	10	300
PI0412S	3/8	10	200
PI0416S	1/2	10	100

STEM ADAPTER NPTF THREAD



PART NO.	STEM OD	THREAD NPTF	BAG QTY	BOX QTY
PM050421S	5/32 x 1/8		10	500
PM050422S	5/32 x 1/4		10	500
PI050621S	3/16 x 1/8		10	500
PI050821S	1/4 x 1/8		10	500
PI050822S	1/4 x 1/4		10	500
PI050823S	1/4 x 3/8		10	300
PM050821S	5/16 x 1/8		10	500
PM050822S	5/16 x 1/4		10	500
PM050823S	5/16 x 3/8		10	300
PI051222S	3/8 x 1/4		10	300
PI051223S	3/8 x 3/8		10	300
PI051623S	1/2 x 3/8		10	150
PI051624S	1/2 x 1/2		10	150



STEM ADAPTER BSPT THREAD



PART NO.	STEM OD	THREAD BSPT	BAG QTY	BOX QTY
PI050601S	3/16 x 1/8		10	500
PI050801S	1/4 x 1/8		10	500
PI050802S	1/4 x 1/4		10	500
PM050801S	5/16 x 1/8		10	500
PM050802S	5/16 x 1/4		10	500
PM050803S	5/16 x 3/8		10	300
PI051202S	3/8 x 1/4		10	300
PI051203S	3/8 x 3/8		10	300
PI051603S	1/2 x 3/8		10	200
PI051604S	1/2 x 1/2		10	150

STEM ADAPTER BSPP THREAD



PART NO.	STEM OD	THREAD BSPP	BAG QTY	BOX QTY
PM050812S	5/16 x 1/4		10	500
PI051212S	3/8 x 1/4		10	300
PI051213S	3/8 x 3/8		10	300

REDUCER



PART NO.	STEM OD	TUBE OD	BAG QTY	BOX QTY
PI060605S	3/16 - 5/32		10	500
PI061006S	5/16 - 3/16		10	500
PI061008S	5/16 - 1/4		10	500
PI061206S	3/8 - 3/16		10	500
PI061208S	3/8 - 1/4		10	400
PI061210S	3/8 - 5/16		10	400
PI061610S	1/2 - 5/16		10	300
PI061612S	1/2 - 3/8		10	250

PLUG



PART NO.	STEM OD	BAG QTY	BOX QTY
PM0804S	5/32	10	1000
PI0806S	3/16	10	1000
PI0808S	1/4	10	500
PM0808S	5/16	10	500
PI0812S	3/8	10	400
PI0816S	1/2	10	300

SWIVEL ELBOW NPTF THREAD



PART NO.	TUBE OD	THREAD NPTF	BAG QTY	BOX QTY
PM090421S	5/32 x 1/8		10	400
PM090422S	5/32 x 1/4		10	300
PI090621S	3/16 x 1/8		10	200
PI090821S	1/4 x 1/8		10	200
PI090822S	1/4 x 1/4		10	200
PM090821S	5/16 x 1/8		10	200
PM090822S	5/16 x 1/4		10	200
PM090823S	5/16 x 3/8		10	200
PI091221S	3/8 x 1/8		10	200
PI091222S	3/8 x 1/4		10	100
PI091223S	3/8 x 3/8		10	100
PI091622S	1/2 x 1/4		10	100
PI091623S	1/2 x 3/8		10	50
PI091624S	1/2 x 1/2		10	50

SWIVEL ELBOW BSPT THREAD



PART NO.	TUBE OD	THREAD BSPT	BAG QTY	BOX QTY
PI090601S	3/16 x 1/8		10	200
PI090801S	1/4 x 1/8		10	200
PI090802S	1/4 x 1/4		10	200
PM090801S	5/16 x 1/8		10	200
PM090802S	5/16 x 1/4		10	200
PM090803S	5/16 x 3/8		10	200
PI091202S	3/8 x 1/4		10	100
PI091203S	3/8 x 3/8		10	100
PI091603S	1/2 x 3/8		10	50
PI091604S	1/2 x 1/2		10	50

SWIVEL BRANCH TEE CENTER LEG NPTF THREAD



PART NO.	TUBE OD	THREAD NPTF	BAG QTY	BOX QTY
PM100421S	5/32 x 1/8		10	200
PM100422S	5/32 x 1/4		10	200
PI100621S	3/16 x 1/8		10	200
PI100821S	1/4 x 1/8		10	200
PI100822S	1/4 x 1/4		10	200
PM100821S	5/16 x 1/8		10	100
PM100822S	5/16 x 1/4		10	100
PM100823S	5/16 x 3/8		10	100
PI1101222S	3/8 x 1/4		10	100
PI1101223S	3/8 x 3/8		10	100
PI1101623S	1/2 x 3/8		10	50
PI1101624S	1/2 x 1/2		10	50

SWIVEL BRANCH TEE CENTER LEG BSPT THREAD



PART NO.	TUBE OD	THREAD BSPT	BAG QTY	BOX QTY
PI100601S	3/16 x 1/8		10	200
PI100801S	1/4 x 1/8		10	200
PI100802S	1/4 x 1/4		10	200
PM100801S	5/16 x 1/8		10	100
PM100802S	5/16 x 1/4		10	100
PM100803S	5/16 x 3/8		10	100
PI101202S	3/8 x 1/4		10	100
PI101203S	3/8 x 3/8		10	100
PI101603S	1/2 x 3/8		5	50
PI101604S	1/2 x 1/2		5	50

SWIVEL MALE RUN TEE NPTF THREAD



PART NO.	TUBE OD	THREAD NPTF	BAG QTY	BOX QTY
PM110421S	5/32 x 1/8		10	400
PM110422S	5/32 x 1/4		10	400
PI110621S	3/16 x 1/8		10	200
PI110821S	1/4 x 1/8		10	200
PI110822S	1/4 x 1/4		10	200
PM110821S	5/16 x 1/8		10	100
PM110822S	5/16 x 1/4		10	100
PM110823S	5/16 x 3/8		10	100
PI111222S	3/8 x 1/4		10	100
PI111223S	3/8 x 3/8		10	100
PI111623S	1/2 x 3/8		10	50
PI111624S	1/2 x 1/2		10	50

SWIVEL MALE RUN TEE BSPT THREAD



PART NO.	TUBE OD	THREAD BSPT	BAG QTY	BOX QTY
PI110601S	3/16 x 1/8		10	200
PI110801S	1/4 x 1/8		10	200
PI110802S	1/4 x 1/4		10	200
PM110801S	5/16 x 1/8		10	100
PM110802S	5/16 x 1/4		10	100
PM110803S	5/16 x 3/8		10	100
PI111202S	3/8 x 1/4		10	100
PI111203S	3/8 x 3/8		10	100
PI111603S	1/2 x 3/8		5	50
PI111604S	1/2 x 1/2		5	50

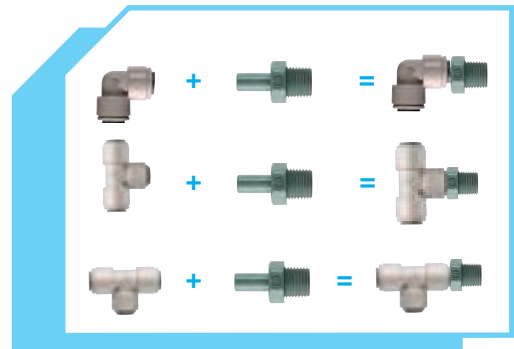

John Guest Adaptability
 Standard *Super Speedfit* products
 can be coupled together to form integral
 new fittings.

BULKHEAD UNION



PART NO.	TUBE OD	MOUNTING HOLE DIA. (INCH)	BAG QTY	BOX QTY
PM1204S	5/32	0.67	10	200
PI1206S	3/16	0.67	10	200
PI1208S	1/4	0.67	10	200
PM1208S	5/16	0.83	10	100
PI1212S	3/8	0.83	10	100
PI1216S	1/2	1.06	5	50

REDUCING BULKHEAD UNION



PART NO.	TUBE OD	TUBE OD	MOUNTING HOLE DIA. (INCH)	BAG QTY	BOX QTY
NC392-02	1/2	1/4	0.83	5,000	5,000
PI121208S	3/8	1/4	0.83	10	200

• Bulk Packed

ENLARGER



PART NO.	STEM OD	TUBE OD	BAG QTY	BOX QTY
PI131012S	5/16	3/8	10	250
PI131216S	3/8	1/2	10	200

REDUCING UNION CONNECTOR



PART NO.	TUBE OD	TUBE OD	BAG QTY	BOX QTY
PI200806S	1/4	3/16	10	200
PM200804S	5/16	5/32	10	300
PI201006S	5/16	3/16	10	200
PI201008S	5/16	1/4	10	200
PI201206S	3/8	3/16	10	200
PI201208S	3/8	1/4	10	200
PI201210S	3/8	5/16	10	200
PI201608S	1/2	1/4	10	200
PI201610S	1/2	5/16	10	100
PI201612S	1/2	3/8	10	100

NEW

REDUCING ELBOW



PART NO.	TUBE OD	TUBE OD	BAG QTY	BOX QTY
PM210804S	5/16	5/32	10	300
PI211006S	5/16	3/16	10	200
PI211008S	5/16	1/4	10	200
PI211206S	3/8	3/16	10	200
PI211208S	3/8	1/4	10	200
PI211210S	3/8	5/16	10	200
PI211610S	1/2	5/16	10	100
PI211612S	1/2	3/8	10	100

PLUG IN ELBOW



PART NO.	STEM OD	TUBE OD	BAG QTY	BOX QTY
PM220404S	5/32	5/32	10	500
PI220606S	3/16	3/16	10	500
PI220808S	1/4	1/4	10	500
PM220808S	5/16	5/16	10	400
PI221206S	3/8	3/16	10	300
PI221208S	3/8	1/4	10	300
PI221210S	3/8	5/16	10	200
PI221212S	3/8	3/8	10	200
PI221616S	1/2	1/2	10	100

TWO-WAY DIVIDER



PART NO.	TUBE OD	BAG QTY	BOX QTY
PI2308S	1/4	10	150
PM2308S	5/16	10	100
PI2312S	3/8	10	100
PI2316S	1/2	5	100

UNEQUAL TWO-WAY DIVIDER



PART NO.	TUBE OD INLET	TUBE OD OUTLET	BAG QTY	BOX QTY
PI241210S	3/8	5/16	10	100

TUBE TO HOSE STEM



PART NO.	STEM OD	HOSE ID	BAG QTY	BOX QTY
PI250806S	1/4	3/16	10	500
PI250808S	1/4	1/4	10	500
PI250810S	1/4	5/16	10	500
PI251006S	5/16	3/16	10	500
PI251008S	5/16	1/4	10	500
PM250808S	5/16	5/16	10	500
PI251012S	5/16	3/8	10	400
PI251208S	3/8	1/4	10	400
PI251210S	3/8	5/16	10	400
PI251212S	3/8	3/8	10	400
PI251216S	3/8	1/2	10	300
PI251612S	1/2	3/8	10	300
PI251616S	1/2	1/2	10	200

TUBE TO HOSE STEM LONG VERSION



PART NO.	STEM OD	HOSE ID	BAG QTY	BOX QTY
PI251012SL	5/16	3/8	10	400
PI251212SL	3/8	3/8	10	400

TUBE TO HOSE ELBOW



PART NO.	STEM OD	HOSE ID	BAG QTY	BOX QTY
PI290808S	1/4	1/4	10	500
PI290810S	1/4	5/16	10	500
PI291008S	5/16	1/4	10	500
PM290808S	5/16	5/16	10	500
PI291208S	3/8	1/4	10	400
PI291210S	3/8	5/16	10	400

REDUCING TEE



PART NO.	TUBE OD ENDS	TUBE OD BRANCH	BAG QTY	BOX QTY
PI301208S	3/8	1/4	10	150
PI301612S	1/2	3/8	10	50

ACCESSORIES FOR PI FITTINGS ARE SHOWN ON PAGE 25.



FAUCET CONNECTOR BSPP THREAD

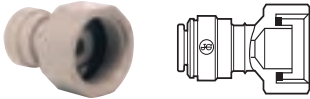

PART NO.	TUBE OD	THREAD BSPP	BAG QTY	BOX QTY
----------	---------	-------------	---------	---------

CI320814S	1/4	x 1/2	10	150
CI320816S	1/4	x 3/4	10	150
CI321214S	3/8	x 1/2	10	100
CI321216S	3/8	x 3/4	10	100

Not suitable for air

NEW FEMALE CONNECTOR BSP THREAD



PART NO.	TUBE OD	X	THREAD BSP	BAG QTY	BOX QTY
----------	---------	---	------------	---------	---------

CI320816FS	1/4	x	3/4	150	150
CI321216FS	3/8	x	3/4	100	100

Not suitable for air

FAUCET CONNECTOR UNS THREAD

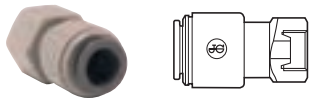

PART NO.	TUBE OD	THREAD UNS	BAG QTY	BOX QTY
----------	---------	------------	---------	---------

CI3208U7S	1/4	x 7/16 - 24	10	250
CI3210U7S	5/16	x 7/16 - 24	10	300
CI3212U7S	3/8	x 7/16 - 24	10	200

Not suitable for air

7/16 - 24 UNS = 1/4 Compression Threads

FEMALE CONNECTOR NPTF THREAD



PART NO.	TUBE OD	THREAD NPTF	BAG QTY	BOX QTY
----------	---------	-------------	---------	---------

PI450822S	1/4	x 1/4	10	400
PI451222S	3/8	x 1/4	10	250

FEMALE CONNECTOR UN THREAD



PART NO.	TUBE OD	THREAD UN	BAG QTY	BOX QTY
----------	---------	-----------	---------	---------

PM4508C5S	5/16	x 1/2 - 16	10	200
PI4512C5S	3/8	x 1/2 - 16	10	200
PI4516C5S	1/2	x 1/2 - 16	10	200

FEMALE FLARE CONNECTOR FFL THREAD

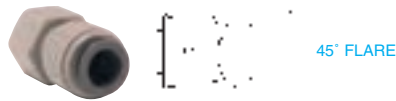

PART NO.	TUBE OD	THREAD FFL	BAG QTY	BOX QTY
----------	---------	------------	---------	---------

PM4508F4S	5/16	x 1/4	10	300
PI4512F4S	3/8	x 1/4	10	250
PI4512F6S	3/8	x 3/8	10	200

1/4 (FFL) corresponds to a 7/16 - 20 UNF

3/8 (FFL) corresponds to a 5/8 - 18 UNF

FEMALE CONNECTOR BSPP THREAD - CONE END



PART NO.	TUBE OD	THREAD BSPP	BAG QTY	BOX QTY
----------	---------	-------------	---------	---------

PI451014CS	5/16	x 1/2	10	150
PI451015CS	5/16	x 5/8	10	150
PI451214CS	3/8	x 1/2	10	150
PI451215CS	3/8	x 5/8	10	100
PI451614CS	1/2	x 1/2	10	150
PI451616CS	1/2	x 3/4	10	100

FEMALE CONNECTOR BSPP THREAD - FLAT END



PART NO.	TUBE OD	THREAD BSPP	BAG QTY	BOX QTY
----------	---------	-------------	---------	---------

PI451014FS	5/16	x 1/2	10	150
PI451015FS	5/16	x 5/8	10	150
PI451213S	3/8	x 3/8	10	150
PI451214FS	3/8	x 1/2	10	150
PI451215FS	3/8	x 5/8	10	150
PI451613S	1/2	x 3/8	10	150
PI451615FS	1/2	x 5/8	10	150

END STOP



PART NO.	TUBE OD	BAG QTY	BOX QTY
----------	---------	---------	---------

PI4608S	1/4	10	500
PI4612S	3/8	10	500

CROSS



PART NO.	TUBE OD	BAG QTY	BOX QTY
----------	---------	---------	---------

PI4712S	3/8	10	100
---------	-----	----	-----

FIXED ELBOW NPTF THREAD



PART NO.	TUBE OD	THREAD NPTF	BAG QTY	BOX QTY
----------	---------	-------------	---------	---------

PI480821S	1/4	x 1/8	10	500
PI480822S	1/4	x 1/4	10	400
PI480823S	1/4	x 3/8	10	300
PI481022S	5/16	x 1/4	10	300
PI481023S	5/16	x 3/8	10	300
PI481222S	3/8	x 1/4	10	200
PI481223S	3/8	x 3/8	10	200
PI482024S	5/8	x 1/2	10	100

THREE WAY DIVIDER



PART NO.	TUBE INLET	TUBE OD OUTLET	BAG QTY	BOX QTY
----------	------------	----------------	---------	---------

PI491612S	1/2	- 3/8	10	50
PI491212S-R	3/8	- 3/8	10	50
PI491616S	1/2	- 1/2	10	40

DISPENSING VALVE ELBOW



PART NO.	TUBE OD	STEM OD	BAG QTY	BOX QTY
----------	---------	---------	---------	---------

NC356-02	3/8	- 3/8	10	250
----------	-----	-------	----	-----

DISPENSING VALVE STEM



PART NO.	STEM OD	BAG QTY	BOX QTY
----------	---------	---------	---------

NC730-02	3/8	10	500
----------	-----	----	-----

OFFSET CONNECTOR



PART NO.	TUBE OD	TUBE OD	BAG QTY	BOX QTY
----------	---------	---------	---------	---------

NC641	1/2	- 5/16	10	200
-------	-----	--------	----	-----

U-BEND

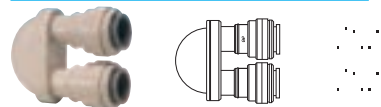

PART NO.	TUBE OD	BAG QTY	BOX QTY
----------	---------	---------	---------

PIUB12S	3/8	10	100
PIUB16S	1/2	10	50

The U-Bend is offered for 1/2 inch OD tube sizes. Existing 1/2 inch ID lines can be accommodated by using a standard Tube to Hose Stem.

Inch Acetal Fittings (White)



The CI Range of inch-size fittings is offered for tube sizes 1/4" O.D. and 3/8" O.D. The fittings are manufactured in white acetal, with a food grade EPDM O-ring. They have been developed for the water industry but are equally suitable for other potable liquids. They are also recommended for intermittent hot water applications.

Selected items are available with red or blue collets.

The CI Range is NOT suitable for compressed air applications.
For these situations we recommend the PI Range on pages 9 - 12.

Working Pressures and Temperatures

Water Max. 150 psi at 70°F (Max. 10 bar at 20°C)
Max. 100 psi at 150°F (Max. 7 bar at 65°C)
Min. 33°F/1°C

Detailed technical information is shown on page 31.

Prices are subject to change without notice.

MALE CONNECTOR NPTF THREAD



PART NO.	TUBE OD	THREAD NPTF	BAG QTY	BOX QTY
----------	---------	-------------	---------	---------

CI010821W	1/4	x 1/8	10	500
CI010822W	1/4	x 1/4	10	400
CI010823W	1/4	x 3/8	10	300
CI011222W	3/8	x 1/4	10	250

UNION TEE



PART NO.	TUBE OD	BAG QTY	BOX QTY
----------	---------	---------	---------

CI0208W	1/4	10	300
CI0212W	3/8	10	100

Blue Collet

CI0208WB	1/4	10	300
----------	-----	----	-----

UNION ELBOW



PART NO.	TUBE OD	BAG QTY	BOX QTY
----------	---------	---------	---------

CI0308W	1/4	10	400
CI0312W	3/8	10	200

Blue Collet

CI0312WB	3/8	10	200
----------	-----	----	-----

Red Collet

CI0312WR	3/8	10	200
----------	-----	----	-----

UNION CONNECTOR



PART NO.	TUBE OD	BAG QTY	BOX QTY
----------	---------	---------	---------

CI0408W	1/4	10	400
CI0412W	3/8	10	200

STEM ADAPTER NPTF THREAD



PART NO.	STEM OD	THREAD NPTF	BAG QTY	BOX QTY
----------	---------	-------------	---------	---------

CI050821W	1/4	x 1/8	10	500
CI050822W	1/4	x 1/4	10	500
CI051222W	3/8	x 1/4	10	300
CI051223W	3/8	x 3/8	10	300

REDUCER



PART NO.	STEM OD	TUBE OD	BAG QTY	BOX QTY
----------	---------	---------	---------	---------

CI061208W	3/8	- 1/4	10	400
-----------	-----	-------	----	-----

BULKHEAD UNION



PART NO.	TUBE OD	MOUNTING HOLE DIA. (INCH)	BAG QTY	BOX QTY
----------	---------	---------------------------	---------	---------

CI1208W	1/4	0.67	10	200
---------	-----	------	----	-----

REDUCING ELBOW



PART NO.	TUBE OD	TUBE OD	BAG QTY	BOX QTY
----------	---------	---------	---------	---------

CI211206W	3/8	- 3/16	10	200
-----------	-----	--------	----	-----

FEMALE ADAPTER NPTF THREAD



PART NO.	STEM OD	THREAD NPTF	BAG QTY	BOX QTY
----------	---------	-------------	---------	---------

CI451222W	3/8	- 1/4	10	250
-----------	-----	-------	----	-----

NEW FEMALE ADAPTER BSP FLA/SEAL



PART NO.	TUBE OD	THREAD BSP	BAG QTY	BOX QTY
----------	---------	------------	---------	---------

CI450814F	1/4	x 1/2	10	150
-----------	-----	-------	----	-----

PLUG IN ELBOW



PART NO.	STEM OD	TUBE OD	BAG QTY	BOX QTY
----------	---------	---------	---------	---------

CI220808W	1/4	- 1/4	10	500
CI221208W	3/8	- 1/4	10	300
CI221212W	3/8	- 3/8	10	200

Blue Collet

CI220808WB	1/4	- 1/4	10	500
CI221212WB	3/8	- 3/8	10	200

Red Collet

CI220808WR	1/4	- 1/4	10	500
CI221212WR	3/8	- 3/8	10	200

BARB CONNECTOR SUPERSEAL X BARB



PART NO.	SUPERSEAL OD	HOSE ID	BAG QTY	BOX QTY
----------	--------------	---------	---------	---------

CI270808W	1/4	- 1/4	10	300
-----------	-----	-------	----	-----

TUBE TO HOSE ELBOW



PART NO.	STEM OD	HOSE ID	BAG QTY	BOX QTY
----------	---------	---------	---------	---------

CI291208W	3/8	- 1/4	10	400
-----------	-----	-------	----	-----

FIXED ELBOW NPTF THREAD

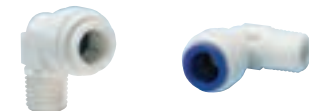

PART NO.	TUBE OD	THREAD NPTF	BAG QTY	BOX QTY
----------	---------	-------------	---------	---------

CI480821W	1/4	x 1/8	10	500
CI480822W	1/4	x 1/4	10	400
CI480823W	1/4	x 3/8	10	300
CI481222W	3/8	x 1/4	10	200

Blue Collet

CI480821WB	1/4	x 1/8	10	500
------------	-----	-------	----	-----

STACKABLE TEE CONNECTOR



PART NO.	TUBE OD	STEM OD	TUBE OD	BAG QTY	BOX QTY
----------	---------	---------	---------	---------	---------

CI530808W	1/4	- 1/4	- 1/4	10	300
-----------	-----	-------	-------	----	-----

BRANCH STEM TEE



PART NO.	TUBE OD	TUBE OD	STEM OD	BAG QTY	BOX QTY
----------	---------	---------	---------	---------	---------

CI580808W	1/4	- 1/4	- 1/4	10	300
-----------	-----	-------	-------	----	-----

Inch Superseal Fittings



For use with Stainless Steel Tubing

The SI Range of inch-size push-in fittings is offered for tube sizes 1/4" O.D. to 3/8" O.D. Superseal is a special fitting designed to provide extra grip on stainless steel tubes.

The Superseal design features a collet with integrally molded stainless steel teeth similar to the standard Super Speedfit design, but incorporating an additional hand-operated nut and wedge shaped plastic washer to apply extra pressure to the collet and the double O-ring seals. This ensures that the collet teeth bite thoroughly into the tube to provide grip, while at the same time compressing the o-rings to further enhance sealing.

Like other John Guest Fittings, Superseal is suitable for potable liquids and other food quality applications.

Detailed technical information is shown on page 31.

Prices are subject to change without notice.

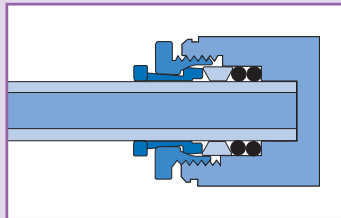
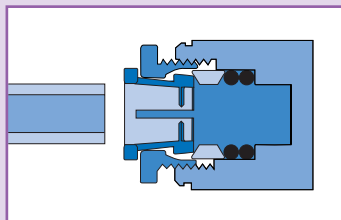

UNION ELBOW SUPERSEAL – SPEEDFIT



PART NO.	SUPERSEAL OD	SPEEDFIT OD	BAG QTY	BOX QTY
SI030812S	1/4	3/8	10	150
SM030808S	5/16	5/16	10	200
SI031012S	5/16	3/8	10	150
SI031210S	3/8	5/16	10	150
SI031212S	3/8	3/8	10	150

UNION ELBOW SUPERSEAL – SUPERSEAL



PART NO.	SUPERSEAL OD	SUPERSEAL OD	BAG QTY	BOX QTY
SM400808S	5/16	5/16	10	150
SI401210S	3/8	5/16	10	150
SI401212S	3/8	3/8	10	150

UNION CONNECTOR SUPERSEAL – SUPERSEAL



PART NO.	SUPERSEAL OD	BAG QTY	BOX QTY
SM410808E	5/16	10	200

UNION CONNECTOR SUPERSEAL – SPEEDFIT



PART NO.	SUPERSEAL OD	SPEEDFIT OD	BAG QTY	BOX QTY
SM040808S	5/16	5/16	10	200
SI041012S	5/16	3/8	10	200
SI041016S	5/16	1/2	10	200
SI041210S	3/8	5/16	10	200
SI041212S	3/8	3/8	10	150

FLOW BEND CONNECTOR SUPERSEAL – SPEEDFIT



PART NO.	SUPERSEAL OD	SPEEDFIT OD	BAG QTY	BOX QTY
SM420808S	5/16	5/16	10	100
SI421012S	5/16	3/8	10	100
SI421210S	3/8	5/16	10	100
SI421212S	3/8	3/8	10	100

MALE CONNECTOR BSPT THREAD



PART NO.	SUPERSEAL OD	THREAD BSPT	BAG QTY	BOX QTY
SM010802S	5/16	x 1/4	10	200

MALE CONNECTOR BSPP THREAD



PART NO.	SUPERSEAL OD	THREAD BSPP	BAG QTY	BOX QTY
SM010812S	5/16	x 1/4	10	200

FLARE MALE CONNECTOR MFL THREAD



PART NO.	SUPERSEAL OD	THREAD MFL	BAG QTY	BOX QTY
SM0108F4S	5/16	x 1/4	10	200

BARB CONNECTOR



PART NO.	SUPERSEAL OD	HOSE ID	BAG QTY	BOX QTY
SI270808S	1/4	1/4	10	300
SI271008S	5/16	1/4	10	250
SI271208S	3/8	1/4	10	200

SPANNER



PART NO.	SIZE	BAG QTY	BOX QTY
SPAN1	5/16 & 3/8	1	200

Metric Polypropylene Fittings

Lead Free



The PPM Range of metric size push-in fittings is offered for our tube sizes 8mm O.D. to 15mm O.D. The fittings are manufactured in white polypropylene with EPDM o-rings. They have been developed to satisfy the compatibility needs for a wide range of applications.

The PPM Range is NOT suitable for compressed air applications. For these situations we recommend the PM Range on pages 16-18.

Working Pressures and Temperatures

Water Max. 150 psi at 70°F (Max. 10 bar at 20°C)
 Max. 60 psi at 140°F (Max. 4 bar at 60°C)
 Min. 33°F/1°C

Detailed technical information is shown on page 31.

Prices are subject to change without notice.



UNION CONNECTOR



PART NO.	TUBE OD	BAG QTY	BOX QTY
PPM0408W	8	10	300
PPM0412W	12	10	100

UNION ELBOW



PART NO.	TUBE OD	BAG QTY	BOX QTY
PPM0308W	8	10	300
PPM0312W	12	10	100

UNION TEE



PART NO.	TUBE OD	BAG QTY	BOX QTY
PPM0208W	8	10	200
PPM0212W	12	10	80

REDUCING UNION CONNECTOR



PART NO.	TUBE OD	TUBE OD	BAG QTY	BOX QTY
PPM201512W	15	12	10	100

PLUG-IN ELBOW



PART NO.	STEM OD	TUBE OD	BAG QTY	BOX QTY
PPM220808W	8	8	10	400
PPM221212W	12	12	10	100

REDUCER



PART NO.	STEM OD	TUBE OD	BAG QTY	BOX QTY
PPM061512W	15	12	10	150

PLUG



PART NO.	TUBE OD	BAG QTY	BOX QTY
PPM0808W	8	10	500

DIVIDER



PART NO.	TUBE OD	BAG QTY	BOX QTY
PPM2312W	12	10	80

Adapters to convert to Inch sizes are shown on page 22.



Metric Acetal Fittings



The PM Range of metric-size push-in fittings is offered for tube sizes 4mm O.D. to 28mm O.D. The fittings are manufactured in black acetal copolymer with food grade nitrile O-rings. Especially produced for foodstuff and potable liquids, they are equally suitable for air and inert gases and can therefore be used on CO₂ lines, pneumatics applications and vacuum.

Detailed technical information is shown on page 31.

Prices are subject to change without notice.



MALE CONNECTOR

BSPT THREAD



PART NO.	TUBE OD (MM)	THREAD BSPT (IN)	BAG QTY	BOX QTY
PM010401E	4 x	1/8	10	500
PM010402E	4 x	1/4	10	500
PM010501E	5 x	1/8	10	500
PM010502E	5 x	1/4	10	500
PM010601E	6 x	1/8	10	500
PM010602E	6 x	1/4	10	500
PM010801E	8 x	1/8	10	400
PM010802E	8 x	1/4	10	400
PM010803E	8 x	3/8	10	300
PM011002E	10 x	1/4	10	250
PM011003E	10 x	3/8	10	250
PM011004E	10 x	1/2	10	200
PM011203E	12 x	3/8	10	150
PM011204E	12 x	1/2	10	150

UNION TEE



PART NO.	TUBE OD (MM)	BAG QTY	BOX QTY
PM0204E	4	10	400
PM0205E	5	10	400
PM0206E	6	10	300
PM0208E	8	10	200
PM0210E	10	10	100
PM0212E	12	10	50
PM0215E	15	5	50
PM0218E	18	5	30
PM0222E	22	5	20
PM0228E	28	1	10

UNION ELBOW



PART NO.	TUBE OD (MM)	BAG QTY	BOX QTY
PM0304E	4	10	500
PM0305E	5	10	500
PM0306E	6	10	400
PM0308E	8	10	300
PM0310E	10	10	200
PM0312E	12	10	100
PM0315E	15	10	50
PM0318E	18	5	50
PM0322E	22	5	30
PM0328E	28	10	20

UNION CONNECTOR



PART NO.	TUBE OD (MM)	BAG QTY	BOX QTY
PM0404E	4	10	500
PM0405E	5	10	500
PM0406E	6	10	400
PM0408E	8	10	300
PM0410E	10	10	200
PM0412E	12	10	100
PM0415E	15	10	100
PM0418E	18	10	50
PM0422E	22	10	50
PM0428E	28	10	25

MALE CONNECTOR

BSPP THREAD



PART NO.	TUBE OD (MM)	THREAD BSPP (IN)	BAG QTY	BOX QTY
PM010411E	4 x	1/8	10	500
PM010412E	4 x	1/4	10	500
PM010511E	5 x	1/8	10	500
PM010512E	5 x	1/4	10	500
PM010611E	6 x	1/8	10	500
PM010612E	6 x	1/4	10	500
PM010811E	8 x	1/8	10	400
PM010812E	8 x	1/4	10	400
PM010813E	8 x	3/8	10	300
PM011012E	10 x	1/4	10	250
PM011013E	10 x	3/8	10	250
PM011014E	10 x	1/2	10	200
PM011213E	12 x	3/8	10	150
PM011214E	12 x	1/2	10	150
PM011514E	15 x	1/2	10	150
PM011814E	18 x	1/2	10	70
PM012216E	22 x	3/4	10	50

PART NO.	TUBE OD (MM)	THREAD NPTF (IN)	BAG QTY	BOX QTY
PM010622E	6 x	1/4	10	500

STEM ADAPTER

BSPT THREAD



PART NO.	STEM OD (MM)	THREAD BSPT (IN)	BAG QTY	BOX QTY
PM050401E	4 x	1/8	10	500
PM050402E	4 x	1/4	10	500
PM050501E	5 x	1/8	10	500
PM050502E	5 x	1/4	10	500
PM050601E	6 x	1/8	10	500
PM050602E	6 x	1/4	10	500
PM050801E	8 x	1/8	10	500
PM050802E	8 x	1/4	10	500
PM050803E	8 x	3/8	10	300
PM051002E	10 x	1/4	10	300
PM051003E	10 x	3/8	10	300
PM051004E	10 x	1/2	10	200
PM051203E	12 x	3/8	10	200
PM051204E	12 x	1/2	10	150

STEM ADAPTER

BSPP THREAD



PART NO.	STEM OD (MM)	THREAD BSPP (IN)	BAG QTY	BOX QTY
PM050411E	4 x	1/8	10	500
PM050412E	4 x	1/4	10	500
PM050511E	5 x	1/8	10	500
PM050512E	5 x	1/4	10	500
PM050611E	6 x	1/8	10	500
PM050612E	6 x	1/4	10	500
PM050811E	8 x	1/8	10	500
PM050812E	8 x	1/4	10	500
PM050813E	8 x	3/8	10	300
PM051012E	10 x	1/4	10	300
PM051013E	10 x	3/8	10	300
PM051014E	10 x	1/2	10	200
PM051213E	12 x	3/8	10	200
PM051214E	12 x	1/2	10	150
PM051513E	15 x	3/8	10	150
PM051514E	15 x	1/2	10	100
PM051814E	18 x	1/2	10	100
PM052214E	22 x	1/2	10	100
PM052216E	22 x	3/4	10	50

REDUCER

PART NO.	STEM OD (MM)	TUBE OD (MM)	BAG QTY	BOX QTY
PM060504E	5	4	10	500
PM060604E	6	4	10	500
PM060605E	6	5	10	500
PM060804E	8	4	10	500
PM060805E	8	5	10	500
PM060806E	8	6	10	500
PM061006E	10	6	10	400
PM061008E	10	8	10	400
PM061208E	12	8	10	300
PM061210E	12	10	10	250
PM061510E	15	10	10	200
PM061512E	15	12	10	100
PM061815E	18	15	10	100
PM062215E	22	15	10	50
PM062218E	22	18	10	50
PM062815E	28	15	10	50
PM062822E	28	22	10	50

PLUG

PART NO.	STEM OD (MM)	BAG QTY	BOX QTY
PM0804R	4	10	1000
PM0805R	5	10	1000
PM0806R	6	10	500
PM0808R	8	10	500
PM0810R	10	10	400
PM0812R	12	10	300

R-Denotes Red Color Plug.

SWIVEL ELBOW

BSPT THREAD



PART NO.	TUBE OD (MM)	THREAD BSPT (IN)	BAG QTY	BOX QTY
PM090401E	4	x 1/8	10	400
PM090402E	4	x 1/4	10	300
PM090501E	5	x 1/8	10	400
PM090502E	5	x 1/4	10	300
PM090601E	6	x 1/8	10	200
PM090602E	6	x 1/4	10	200
PM090801E	8	x 1/8	10	200
PM090802E	8	x 1/4	10	200
PM090803E	8	x 3/8	10	200
PM091002E	10	x 1/4	10	100
PM091003E	10	x 3/8	10	100
PM091004E	10	x 1/2	10	100
PM091203E	12	x 3/8	10	50
PM091204E	12	x 1/2	10	50

SWIVEL ELBOW

BSPP THREAD



PART NO.	TUBE OD (MM)	THREAD BSPP (IN)	BAG QTY	BOX QTY
PM090411E	4	x 1/8	10	400
PM090412E	4	x 1/4	10	200
PM090511E	5	x 1/8	10	400
PM090512E	5	x 1/4	10	200
PM090611E	6	x 1/8	10	200
PM090612E	6	x 1/4	10	200
PM090811E	8	x 1/8	10	200
PM090812E	8	x 1/4	10	200
PM090813E	8	x 3/8	10	200
PM091012E	10	x 1/4	10	100
PM091013E	10	x 3/8	10	100
PM091014E	10	x 1/2	10	100
PM091213E	12	x 3/8	10	50
PM091214E	12	x 1/2	10	50

SWIVEL BRANCH TEE

BSPT THREAD



PART NO.	TUBE OD (MM)	THREAD BSPT (IN)	BAG QTY	BOX QTY
PM100401E	4	x 1/8	10	200
PM100402E	4	x 1/4	10	200
PM100501E	5	x 1/8	10	200
PM100502E	5	x 1/4	10	200
PM100601E	6	x 1/8	10	200
PM100602E	6	x 1/4	10	200
PM100801E	8	x 1/8	10	100
PM100802E	8	x 1/4	10	100
PM100803E	8	x 3/8	10	100
PM101002E	10	x 1/4	10	100
PM101003E	10	x 3/8	10	100
PM101004E	10	x 1/2	10	100
PM101203E	12	x 3/8	10	50
PM101204E	12	x 1/2	5	50

SWIVEL BRANCH TEE

BSPP THREAD



PART NO.	TUBE OD (MM)	THREAD BSPP (IN)	BAG QTY	BOX QTY
PM100411E	4	x 1/8	10	200
PM100412E	4	x 1/4	10	200
PM100511E	5	x 1/8	10	200
PM100512E	5	x 1/4	10	200
PM100611E	6	x 1/8	10	200
PM100612E	6	x 1/4	10	200
PM100811E	8	x 1/8	10	100
PM100812E	8	x 1/4	10	100
PM100813E	8	x 3/8	10	100
PM101012E	10	x 1/4	10	100
PM101013E	10	x 3/8	10	100
PM101014E	10	x 1/2	10	50
PM101213E	12	x 3/8	5	50
PM101214E	12	x 1/2	5	50

SWIVEL MALE RUN TEE

BSPT THREAD



PART NO.	TUBE OD (MM)	THREAD BSPT (IN)	BAG QTY	BOX QTY
PM110401E	4	x 1/8	10	200
PM110402E	4	x 1/4	10	200
PM110501E	5	x 1/8	10	200
PM110502E	5	x 1/4	10	200
PM110601E	6	x 1/8	10	200
PM110602E	6	x 1/4	10	200
PM110801E	8	x 1/8	10	100
PM110802E	8	x 1/4	10	100
PM110803E	8	x 3/8	10	100
PM111002E	10	x 1/4	10	100
PM111003E	10	x 3/8	10	100
PM111004E	10	x 1/2	10	100
PM111203E	12	x 3/8	10	50
PM111204E	12	x 1/2	5	50

SWIVEL MALE RUN TEE

BSPP THREAD



PART NO.	TUBE OD (MM)	THREAD BSPP (IN)	BAG QTY	BOX QTY
PM110411E	4	x 1/8	10	200
PM110412E	4	x 1/4	10	200
PM110511E	5	x 1/8	10	200
PM110512E	5	x 1/4	10	200
PM110611E	6	x 1/8	10	200
PM110612E	6	x 1/4	10	200
PM110811E	8	x 1/8	10	100
PM110812E	8	x 1/4	10	100
PM110813E	8	x 3/8	10	100
PM111012E	10	x 1/4	10	100
PM111013E	10	x 3/8	10	100
PM111014E	10	x 1/2	10	50
PM111213E	12	x 3/8	5	50
PM111214E	12	x 1/2	10	50

John Guest Adaptability

Standard **Super Speedfit** products can be coupled together to form integral new fittings.

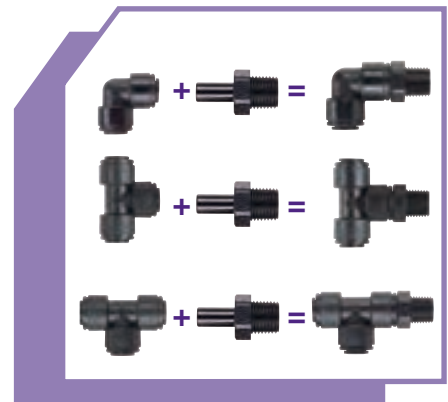

BULKHEAD UNION



PART NO.	TUBE OD (MM)	MOUNTING HOLE DIA. (MM)	BOX QTY	BOX QTY
PM1204E	4	16.5	10	200
PM1205E	5	16.5	10	200
PM1206E	6	16.5	10	200
PM1208E	8	21.0	10	100
PM1210E	10	21.0	10	100
PM1212E	12	26.5	5	50

ENLARGER



PART NO.	STEM OD (MM)	TUBE OD (MM)	BAG QTY	BOX QTY
PM130405E	4	5	10	500

REDUCING UNION



PART NO.	TUBE OD (MM)	TUBE OD (MM)	BAG QTY	BOX QTY
PM200604E	6	4	10	400
PM200804E	8	4	10	300
PM200806E	8	6	10	200
PM201004E	10	4	10	200
PM201006E	10	6	10	200
PM201008E	10	8	10	200
PM201208E	12	8	10	100
PM201210E	12	10	10	100

REDUCING ELBOW



PART NO.	TUBE OD (MM)	TUBE OD (MM)	BAG QTY	BOX QTY
PM210604E	6	4	10	400
PM210804E	8	4	10	300
PM210806E	8	6	10	200
PM211004E	10	4	10	200
PM211006E	10	6	10	200
PM211008E	10	8	10	200
PM211208E	12	8	10	100
PM211210E	12	10	10	100

PLUG IN ELBOW



PART NO.	STEM OD (MM)	TUBE OD (MM)	BAG QTY	BOX QTY
PM220404E	4	4	10	500
PM220505E	5	5	10	500
PM220606E	6	6	10	500
PM220808E	8	8	10	400
PM221010E	10	10	10	200
PM221212E	12	12	10	100
PM221515E	15	15	10	100
PM221818E	18	18	5	50
PM222222E	22	22	10	50

TWO-WAY DIVIDER



PART NO.	TUBE OD (MM)	BAG QTY	BOX QTY
PM2304E	4	10	300
PM2308E	8	10	100
PM2310E	10	10	100
PM2315E	15	5	50

REDUCING TEE



PART NO.	TUBE OD ENDS (MM)	TUBE OD BRANCH (MM)	BAG QTY	BOX QTY
PM3018AE	18	15	5	30
PM3022AE	22	15	5	20

FEMALE CONNECTOR



PART NO.	TUBE OD (MM)	THREAD (IN)	BAG QTY	BOX QTY
PM450411E	4	1/8 BSPP	10	500
PM450611E	6	1/8 BSPP	10	500
PM450612E	6	1/4 BSPP	10	300
PM450812E	8	1/4 BSPP	10	300
PM450813E	8	3/8 BSPP	10	200
PM4508F4S	8	1/4 FFL	10	300
PM4508C5S	8	1/2-16UN	10	200
PM451015FE	10	5/8 BSPP	10	100
PM451215FE	12	5/8 BSPP	10	150

TUBE TO HOSE STEM



PART NO.	STEM OD (MM)	HOSE ID (MM)	BAG QTY	BOX QTY
PM250604E	6	4	10	500
PM250806E	8	6	10	500
PM251008E	10	8	10	300

END STOP



PART NO.	TUBE OD (MM)	BAG QTY	BOX QTY
PM4612E	12	10	250
PM4615E	15	10	200
PM4618E	18	10	150
PM4622E	22	5	80

FIXED ELBOW



PART NO.	TUBE OD (MM)	THREAD NPTF (IN)	BAG QTY	BOX QTY
PM480621E	6	x 1/8	10	500
PM480622E	6	x 1/4	10	400
PM480623E	6	x 3/8	10	300

OFFSET CONNECTOR



PART NO.	TUBE OD (MM)	TUBE OD (MM)	BAG QTY	BOX QTY
NC657	12	8	10	1000

U-BEND



PART NO.	TUBE OD (MM)	BAG QTY	BOX QTY
PMUB15E	15	10	50

ACCESSORIES FOR PM FITTINGS ARE SHOWN ON PAGE 25.





Inch Polypropylene Angle Stop Adapter Valves



The ASVPP Range of inch-size Angle Stop Adapter Valves is offered in white polypropylene with food grade EPDM o-rings. Our Angle Stop Adapter Valve connects between your valve and riser, to the main water supply line, for applications in Reverse Osmosis, Filtration Systems, Automatic Coffee Brewers, Ice-makers, and many more. Please refer to our Technical Support Department for guidance on use with other potable liquids.

The valves are not to be used with compressed air, explosive gases, petroleum spirits and other fuels, or for heating systems.

FOR COLD WATER SUPPLY ONLY.

Working Pressures and Temperatures

Water Max. 150 psi at 70°F (Max. 10 bar at 20°C)
Min. 33°F/1°C

Detailed technical information is shown on page 31.

Prices are subject to change without notice.

ANGLE STOP ADAPTER VALVE •

PART NO.	THREAD MALE COMPRESSION		THREAD FEMALE COMPRESSION		TUBE OD	BAG QTY	BOX QTY
ASVPP1LF	3/8"	x	3/8"	x	1/4"	1	30
ASVPP2LF	3/8"	x	3/8"	x	3/8"	1	30



ANGLE STOP ADAPTER VALVE (CONVERSION THREAD) •

PART NO.	THREAD MALE/ FEMALE NPS		THREAD COMPRESSION		TUBE OD	BAG QTY	BOX QTY
ASVPP5LF	1/2"	x	3/8"	x	1/4"	1	40
ASVPP6LF	1/2"	x	3/8"	x	3/8"	1	20



Suffix LF = Contains less than 0.25% lead.

*Conversion Adapter can be threaded to either side of the valve to make configurations of 1/2"x1/2" NPS or 3/8"x3/8" Compression.



How to connect the Angle Stop Adapter Valve

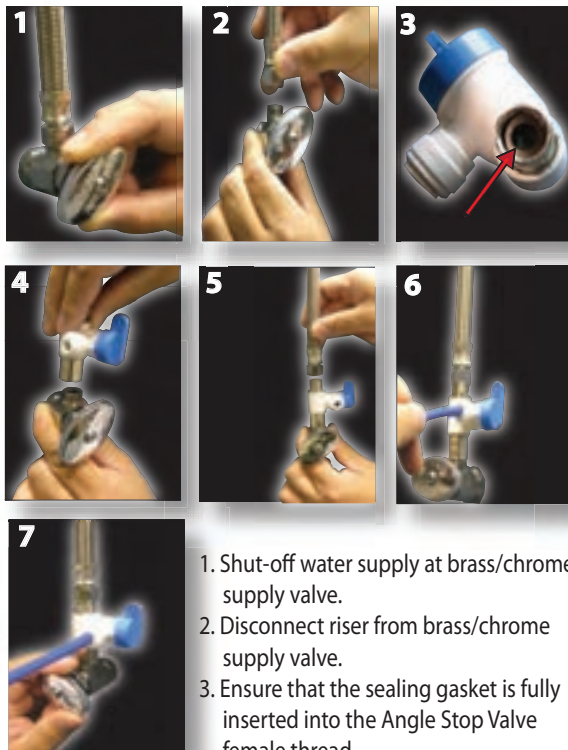

1. Shut-off water supply at brass/chrome supply valve.
2. Disconnect riser from brass/chrome supply valve.
3. Ensure that the sealing gasket is fully inserted into the Angle Stop Valve female thread.
4. Install Angle Stop Adapter Valve on supply valve.
5. Connect the riser to the Angle Stop Adapter Valve.
6. Fully insert tubing into the Speedfit side of the valve.
7. Open valves and check for leaks.

• **1/4 Turn Valves.** These valves have been designed to allow temporary servicing of downstream equipment and must only be used in the fully open or fully closed position.

DO NOT USE THESE VALVES:

- In a partially open position to control flow.
- To provide a permanent termination.
- Without tubing assembled or plugged (or threaded connections sealed).
- As a tap or "faucet".

1/4 Turn Valve are indicated by this marker '•'

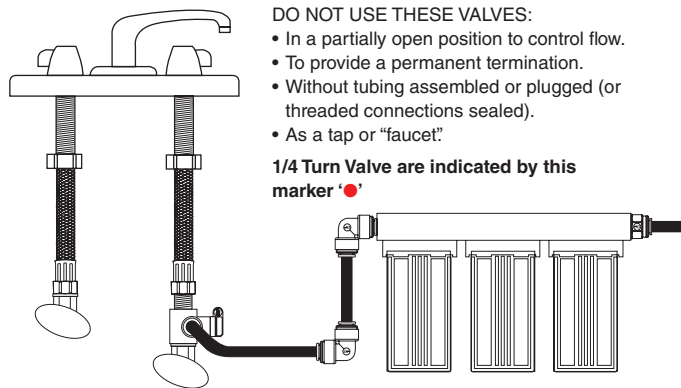

NEW WATER SUPPLY KIT

PART NO.	BAG QTY	BOX QTY
WSK-W (White)	1	12
WSK-B (Blue)	1	12

Includes: 25 feet 1/4" LLDPE Tubing, (1) 1/4" Supply Valve, (1) 1/4" Connector.



ICE MAKER/WATER SUPPLY KIT

PART NO.	BAG QTY	BOX QTY
ICE MAKER KIT	1	12

Includes: 25 feet 1/4" LLDPE Tubing, (1) 1/4" Supply Valve, (1) 1/4" Connector





Inch Polypropylene Angle Stop Adapter Valves

The PASV Range of all plastic inch size Angle Stop Valves is offered in Polypropylene with Polysulphone NPSM Male Threads. The valve is also available with a Female Conversion adapter.

Please refer to our Technical Support Department for guidance on use with other potable liquids.

The valves are not to be used with compressed air, explosive gases, petroleum spirits and other fuels, or for heating systems.

FOR COLD WATER SUPPLY USE ONLY.



Working Pressures and Temperatures

Water Max. 145 psi at 68°F (Max. 10 bar at 20°C)
 Max. 58 psi at 140°F (Max. 4 bar at 60°C)
 Min. 34°F/1°C

Detailed technical information is shown on page 31.

Prices are subject to change without notice.

ANGLE STOP ADAPTER VALVE •



PART NO.	THREAD MALE COMPRESSION	FEMALE COMPRESSION	TUBE OD	BAG QTY	BOX QTY
PASVPP1	3/8" x	3/8" x	1/4"	1	25
PASVPP2	3/8" x	3/8" x	3/8"	1	25

ANGLE STOP ADAPTER VALVE (CONVERSION THREAD) •



PART NO.	THREAD MALE/ FEMALE NPS	FEMALE COMPRESSION	TUBE OD	BAG QTY	BOX QTY
PASVPP5	1/2" x	3/8" x	1/4"	1	25
PASVPP6	1/2" x	3/8" x	3/8"	1	25

*Conversion Adapter can be threaded to either side of the valve to make configurations of 1/2"x1/2" NPS or 3/8"x3/8" Compression.



Inch Polypropylene Shut-Off Valve

The PPSV Range of Shut-Off Valve is offered for tube sizes 1/4" O.D. and 3/8" O.D., produced in polypropylene and fitted with EPDM O-rings. Polypropylene has the advantage of being more chemically resistant than acetal.

The valves are for use with potable water. For use with other potable liquids please contact our Technical Support Department for guidance.

The valves are not to be used with compressed air, explosive gases, petroleum spirits and other fuels or for heating systems.



Working Pressures and Temperatures

Water Max. 150 psi at 70°F (Max. 10 bar at 20°C)
 Max. 60 psi at 140°F (Max. 4 bar at 60°C)
 Min. 33°F/1°C

Detailed technical information is shown on page 31.

Prices are subject to change without notice.



SPEEDFIT TO FEMALE • NPTF THREAD



PART NO.	TUBE OD	THREAD NPTF	BAG QTY	BOX QTY
PPSV451223W	3/8 x	3/8	10	-

Also available in black. Use suffix E.

SPEEDFIT TO MALE • NPTF THREAD



PART NO.	TUBE OD	THREAD NPTF	BAG QTY	BOX QTY
PPSV010822W	1/4 x	1/4	10	200
PPSV011223W	3/8 x	3/8	10	100

SPEEDFIT TO SPEEDFIT •



PART NO.	TUBE OD	BAG QTY	BOX QTY
PPSV040808W	1/4	10	200
PPSV041212W	3/8	10	80

SPEEDFIT TO FEMALE • NPTF THREAD



PART NO.	TUBE OD	THREAD NPTF	BAG QTY	BOX QTY
PPSV500822W	1/4 x	1/4	10	200
PPSV501222W	3/8 x	1/4	10	100



Inch Acetal Shut-Off Valves

The PISV Range of Inch-size Shut-Off Valves is available in 3/8" and 1/2" tube O.D. size. The Valve is manufactured in gray acetal copolymer with a nitrile o-ring.

The valves are available with long and short handles to operate a 1/4 turn off action.

Specifically designed for compressed air and potable liquids, the valves are ideal for CO₂ lines in beverage dispensing and for pneumatic applications.

Working Pressures and Temperatures

Air		150 psi at -4°F (10 bar at -20°C)
Air/Potable Liquids	Max.	150 psi at 33°F (10 bar at 1°C)
		Max. 150 psi at 73°F (10 bar at 23°C)
	Max.	100 psi at 150°F (7 bar at 65°C)

Detailed technical information is shown on page 31.
Prices are subject to change without notice.

It is the customer's responsibility to ensure that the installation of John Guest fittings in CO₂ applications is performed in accordance with the relevant industry and government safety guidelines.

SHUT-OFF VALVE • SHORT HANDLE



PART NO.	TUBE OD	BAG QTY	BOX QTY
PISV0412CS	3/8	10	100

SHUT-OFF VALVE • LONG HANDLE



PART NO.	TUBE OD	BAG QTY	BOX QTY
PISV0412S	3/8	10	100
PISV0416S	1/2	10	50

MOUNTING CLIP



PART NO.	SIZE CTS	BAG QTY	BOX QTY
SVMC-10	3/8"	10	100

The mounting clip is designed to give a very firm grip. A twisting action is needed to remove the valve. The clip can be used with either shut-off valve. When used with the short handle version, valves can be banked together.
Available for 3/8" O.D. valves.

NEW ACETAL ANGLE STOP VALVE •



PART NO.	TUBE OD	BAG QTY	BOX QTY
NC2555	3/8	25	25

Features double O rings in every Speedfit port.

• **1/4 Turn Valves.** These valves have been designed to allow temporary servicing of downstream equipment and must only be used in the fully open or fully closed position.

DO NOT USE THESE VALVES:

- In a partially open position to control flow.
- To provide a permanent termination.
- Without tubing assembled or plugged (or threaded connections sealed).
- As a tap or "faucet".

1/4 Turn Valve are indicated by this marker '•'

Acetal Shut-Off and By-Pass Valves

Working Pressures and Temperatures

Water	Max.	150 psi at 70°F	(Max. 10 bar at 20°C)
	Max.	60 psi at 140°F	(Max. 4 bar at 60°C)
	Min.	34°F/1°C	

Specifically manufactured in white acetal with EPDM 'O'-rings, these valves have been developed to satisfy the requirements of the US Recreational Vehicle (RV) and Mobile Home (MH) markets. The valves are for hot and cold water only.

Not IAPMO Listed

STRAIGHT SHUT-OFF VALVE •



PART NO.	SIZE CTS	BAG QTY	BOX QTY
NC2390	1/2	1	25

BY-PASS VALVES •



PART NO.	SIZE CTS	BAG QTY	BOX QTY
*NC2391-RH	1/2	1	25
**NC2391-LH	1/2	1	25

*RH: Gray Handle
**LH: Black Handle

CHECK VALVE



Super Speedfit Single Check Valves allow flow in one direction.

For liquids only



PART NO.	CRACK PRESSURE PSI	TUBE OD	BAG QTY	BOX QTY
1/4SCV	0.3	1/4	10	300
1/4SCV-R	0.3	1/4	10	300
5/16SCV	0.3	5/16	10	300
3/8SCV	0.3	3/8	1	80
NC2718	5	1/4	10	300
NC2718E	5	1/4	10	300

Inch Brass Fittings

Designed for use in coffee brewing equipment, beverage dispensing and vending machine applications. The fittings are manufactured in brass with a polypropylene collet and a food grade EPDM o-ring. **NOT suitable for compressed air applications.**

Working Pressures and Temperatures

Water Max. 150 psi at 70°F (Max. 10 bar at 20°C)
 Max. 60 psi at 140°F (Max. 4 bar at 60°C)
 Min. 33°F/1°C



Detailed technical information is shown on page 31.

Prices are subject to change without notice.

BRASS FLARE FEMALE CONNECTOR

FFL
THREAD



PART NO.	TUBE OD	THREAD FFL	BAG QTY	BOX QTY
----------	---------	------------	---------	---------

MI4508F4SLF	1/4 x	1/4	10	200
MI4512F4SLF	3/8 x	1/4	10	200
MI4512F6SLF	3/8 x	3/8	10	100

1/4 (FFL) corresponds to a 7/16 - 20 UNF
 3/8 (FFL) corresponds to a 5/8 - 18 UNF

BRASS FEMALE CONNECTOR (GARDEN HOSE)

NH
THREAD
(National Hose)



Threaded brass ring not a wetted surface.

PART NO.	TUBE OD	THREAD N.H.	BAG QTY	BOX QTY
----------	---------	-------------	---------	---------

NC2258	3/8 x	3/4 - 11.5 NH	10	100
--------	-------	---------------	----	-----

BRASS POLYPROPYLENE FEMALE CONNECTOR

BSPP
THREAD



PART NO.	TUBE OD	THREAD BSPP	BAG QTY	BOX QTY
----------	---------	-------------	---------	---------

NC2145LF	1/4 x	3/4	10	150
NC2249LF	3/8 x	3/4	10	100

Suffix LF = Contains less than 0.25% lead.

BRASS FEMALE CONNECTOR (GARDEN HOSE)

NH
THREAD
(National Hose)



PART NO.	TUBE OD	THREAD N.H.	BAG QTY	BOX QTY
----------	---------	-------------	---------	---------

NC2098LF	1/4 x	3/4 - 11.5 NH	10	100
----------	-------	---------------	----	-----

A plug in elbow shown on page 5 will provide a neat 90° installation. The tube can be oriented in any direction.

NEW

FEMALE CONNECTOR



PART NO.	SIZE O.D. X UNEF	BAG QTY	BOX QTY
----------	------------------	---------	---------

PSE16012U9	3/8" x 9/16"-24	10	200
------------	-----------------	----	-----

9/16 - 24 UNEF = 3/8 Compression Threads

Metric to Inch Fittings

UNION CONNECTOR



PART NO.	TUBE OD	TUBE OD	BAG QTY	BOX QTY
----------	---------	---------	---------	---------

NC462	15mm -	1/2"	10	400
-------	--------	------	----	-----

STEM TO TUBE ADAPTER



PART NO.	STEM OD	TUBE OD	BAG QTY	BOX QTY
----------	---------	---------	---------	---------

NC2164	15mm -	3/8"	10	200
NC2173	1/2"	- 15mm	10	100
NC908	1/2"	- 18mm	10	100

TUBE TO HOSE STEM



PART NO.	STEM OD	HOSE ID	BAG QTY	BOX QTY
----------	---------	---------	---------	---------

NC932	15mm -	1/2"	10	150
-------	--------	------	----	-----

BARB CONNECTOR



PART NO.	STEM OD	HOSE ID	BAG QTY	BOX QTY
----------	---------	---------	---------	---------

NC448	15mm -	1/2"	10	1000
-------	--------	------	----	------

TEE ADAPTER



PART NO.	TUBE OD ENDS	TUBE OD BRANCH	BAG QTY BULK	BOX QTY
----------	--------------	----------------	--------------	---------

NC869	15mm -	3/8"	400	400
-------	--------	------	-----	-----

STEM TO STEM ADAPTER



PART NO.	STEM OD	STEM OD	BAG QTY	BOX QTY
----------	---------	---------	---------	---------

NC478	15mm -	3/8"	10	150
-------	--------	------	----	-----

UNION CONNECTOR SUPERSEAL X SPEEDFIT



PART NO.	SUPERSEAL OD	SPEEDFIT OD	BAG QTY	BOX QTY
----------	--------------	-------------	---------	---------

NC2301	15mm -	1/2"	10	80
--------	--------	------	----	----

LLDPE Tubing

The John Guest PE Range of plastic tubing is produced in Linear Low Density Polyethylene for cold and intermittent hot water applications.

Our tubing provides the benefits of a wide range of temperature and pressure suitability, broad chemical compatibility and is made from non contaminating materials. Common applications are in water purification, water conditioners, ice makers and misting systems. LLDPE is more robust than traditional low or medium density polyethylene and is recommended for use with cold and intermittent hot water. Our tubing is made from FDA compliant materials and is NSF International certified. John Guest LLDPE Tubing provides excellent resistance to environmental stress cracking as measured by ASTM D-1693 (10% IGEPAL).

John Guest Polyethylene tubing is designed for use with John Guest Super Speedfit push-fit fittings, John Guest Shut-Off Valves and virtually all standard tubing connectors.

Prices subject to change without notice.

Sizes Available

PART NO.	OD	ID	COIL LENGTH	MINI BEND RADII
PE-08-BI-0500F-N	1/4"(0.250")	0.170"	500 FT	1.00"
PE-08-BI-1000F-N	1/4"(0.250")	0.170"	1000 FT	1.00"
PE-10-CI-0500F-N	5/16"(0.312")	0.187"	500 FT	1.13"
PE-12-EI-0500F-N	3/8"(0.375")	0.250"	500 FT	1.25"
PE-16-GI-0250F-N	1/2"(0.500")	0.375"	250 FT	2.50"
PE-08-BI-3000F-E	1/4"(0.250")	0.170"	3000 FT	1.00"
PE-04025-0100M-N	4mm	2.5mm	100m	25mm
PE-0604-0100M-N	6mm	4mm	100m	25mm
PE-0806-0100M-N	8mm	6mm	100m	30mm
PE-1007-100M-N	10mm	7mm	100m	32mm
PE-1209-100M-N	12mm	9mm	100m	63mm
PE-15115-0100M	15mm	11.5mm	100m	100mm
PE-0604-0300M-E	6mm	4mm	300m	25mm

N denotes natural color. To request other colors please refer to adjacent table. Popular items are now generally in stock and are available in minimum quantities of 2 coils. Other items may be subject to longer lead times and are available in minimum quantities of 50 coils.



Smaller Coils

Part No.	O.D.	Coil Length	Bag Qty.	Box Qty.
PE-08-BI-025F-B	1/4"	25'	1	20
PE-08-BI-025F-N	1/4"	25'	1	20
PE-08-BI-025F-E	1/4"	25"	1	20
PE-08-BI-050F-B	1/4"	50'	1	12
PE-08-BI-050F-N	1/4"	50'	1	12
PE-08-BI-100F-B	1/4"	100'	1	8
PE-08-BI-100F-N	1/4"	100'	1	8

Suffix B = Blue
N = Natural

10 9 Col Strong

Standard Colors Available

SUFFIX

N
NATURAL



B
BLUE



E
BLACK

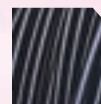

R
RED



W
WHITE



Other special colours available on request:-

Orange (O)
Green (G)
Violet (V)
Yellow (Y)

15mm size only available in Blue, Red, Green and Violet.

8mm size only available in Natural, Blue, Black, Red and White. For other colors we suggest you use 5/8".

Black tubing is UV stabilized.

Sizes

Colors

yet flexible



NSF 51
NSF 61



Tube Tolerances

1/4" to 1/2"	+0.001/-0.004"
4mm	+0.05/-0.07mm
6mm to 12mm	+0.05/-0.10mm
15mm	+0.10/-0.10mm

Working Temperatures and Pressures - LLDPE

TUBE OD		TUBE ID	
1/4"	x	0.170"	230 psi @70°F
5/16"	x	0.187"	
3/8"	x	0.25"	
4mm	x	2.5mm	120 psi @150°F
6mm	x	4mm	
10mm	x	7mm	
1/2"	x	0.375"	150 psi @70°F
8mm	x	6mm	
12mm	x	9mm	90 psi @150°F
15mm	x	11.5mm	

Burst pressures are approximately 3 times the maximum working pressure.

Maximum Working Temperature 150°F at pressures shown in chart above.

For temperatures above 150°F customers should refer to our Technical Help Desk.

The above maximum temperatures and pressures do not take chlorine content into account. This could reduce service life.

Please note maximum pressure rating for a 'system' depends on the lowest rated component, eg. most John Guest fittings have a different rating from the tube ratings shown above.

Burst Pressures are approximately 3 times the maximum working pressure.

Pneumatics Applications

John Guest LLDPE tube is suitable for pneumatic applications providing pressure is maximum 150psi @ 70°F (10 bar @ 20°C). At elevated temperatures 120°F+ (50°C+) mineral oil will degrade LLDPE tube and therefore, LLDPE tube used in pneumatic circuits should be periodically checked and replaced if necessary.

Tube Inserts

If the tube is used in a warm water system a tube insert is necessary.

Exposure to Ultraviolet Light

John Guest Black LLDPE tubing is UV stabilized and can be exposed to direct ultraviolet light (e.g. direct sunlight); other colors of John Guest LLDPE tubing are not UV stabilized and cannot be exposed to direct ultraviolet light.

Chemical Resistance

For use of LLDPE with chemicals or potentially aggressive liquids, please refer to our Technical Service Department.

NOTE: When using cleaning agents or other potentially aggressive liquids, please ensure compatibility with tubing and fittings. LLDPE is not recommended for mineral oils, gases and fuels or high pressure compressed air / pneumatic systems.

Potable Water Applications

John Guest LLDPE tubing is suitable for potable cold water applications with a maximum chlorine content of 4 parts per million (4 ppm). Heating water above 70°F (20°C) and or pressures above the maximum will significantly reduce service life. Direct exposure to sunlight will also significantly reduce its useful service. As part of good practice tubing should be inspected regularly. If there is any evidence of damage, hardening or cracking it should be replaced immediately.

Inch/Metric Accessories

COLLET COVER

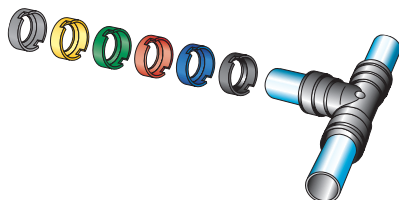

The slip-on Collet Cover shown in the illustration prevents accidental removal or tampering with tubing. Tubing can be inserted with the Collet Cover already attached to the fittings or the cover can slide into position afterwards. The cover is easily removed when required and comes in a variety of colors for color coding.

Colors available - Suffix indicates colors

E = Black Y = Yellow B = Blue

R = Red S = Gray G = Green

Prices are subject to change without notice.

INCH SIZE

PART NO.	TUBE OD	BAG QTY	BOX QTY
----------	---------	---------	---------

PM1904S	5/32	10	1000
PI1906S	3/16	10	1000
PI1908S	1/4	10	1000
PM1908S	5/16	10	1000
PI1912S	3/8	10	500
PI1916S	1/2	10	1000

Please indicate by suffix, color required or gray will be supplied.

METRIC SIZE

PART NO.	TUBE OD	BAG QTY	BOX QTY
----------	---------	---------	---------

PM1904E	4	10	1000
PM1905E	5	10	1000
PM1906E	6	10	1000
PM1908E	8	10	1000
PM1910E	10	10	500
PM1912E	12	10	500
PM1915E	15	100	400
PM1918E	18	10	200
PM1922E	22	50	200

15mm to 22mm sizes are only available in black as standard, white, red or blue.

Please indicate by suffix, color required or black will be supplied.

FLOW BEND CLIP



PART NO.	TUBE OD	BAG QTY	BOX QTY
----------	---------	---------	---------

PM2608S	5/16 (8mm)	10	300
PM2610S	3/8 (10mm)	10	200

Designed to support tube and eliminate kinking.

TUBE INSERT



PART NO.	TUBE ID	TUBE OD	BAG QTY	BOX QTY
----------	---------	---------	---------	---------

TSI250S	1/4	5/16	10	1000
TSI312S	5/16	3/8	100	2500
TSI375S	3/8	1/2	10	500
TSM10N		10	50	1000
TSM15N		15	50	500
TSM22N		22	25	250

COLLET LOCKING/RELEASE TOOL



PART NO.	SIZE	BAG QTY	BOX QTY
----------	------	---------	---------

ICLT/2	3/16 to 1/2	10	50
TSPITool	1/4, 3/8	10	50

TUBE CUTTER



PART NO.	BAG QTY	BOX QTY
----------	---------	---------

TSNIP	1	50
BLADES ONLY	10	300

Suitable for up to 12mm tube.

PIPE CUTTER



PART NO.	BAG QTY	BOX QTY
----------	---------	---------

JG-TS	1	30
-------	---	----

Suitable for up to 22mm pipe.

LOCKING CLIP



	PART NO.	TUBE OD	BAG QTY	BOX QTY
--	----------	---------	---------	---------

Inch	PIC1808R	1/4	100	5000
	PIC1812R	3/8	100	1000
	PIC1816R	1/2	100	2000
Metric	PMC1808R	8mm	100	8000



Secures the collet in its position to prevent an accidental disconnection of the tube.

Locking clips should be connected only after full insertion to prevent scraping of the tube. Locking Clips are not designed for use with John Guest Stem Adapters in Swivel Combinations.

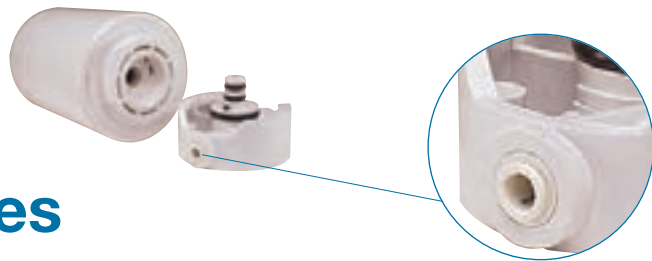

Plastic Half Cartridges

- For Filtration and Food Grade Applications • Inch and Metric Sizes
- For a wide range of plastic and soft metal housing materials
- Low assembly effort - high retention

The John Guest Plastic Half Cartridge provides a quick, efficient and easy way of securing a Speedfit push-in connection into a wide variety of original equipment. As the cartridge requires low insertion loads it is suitable for many different housing materials.

The Half Cartridge is made up of three components; a collet or gripper, an 'O' ring of food grade material, and a plastic body with stainless steel teeth. With the body of the cartridge inserted, the stainless steel teeth grip the sides of the housing. As the system comes under pressure the teeth grip more.

As with all Speedfit products, the push-in connection can be used with plastic or soft metal tubes in both inch and metric sizes. The cartridges are suitable for a very wide selection of original equipment including manifolds and multi-interconnection points, and, because they are produced in food grade materials, Drinks Dispense and Water Purification Equipment.

As Plastic Half Cartridges are intended for use by Original Equipment Manufacturers they are only supplied in bulk quantities.

The John Guest Plastic Cartridge is made up of three components:-

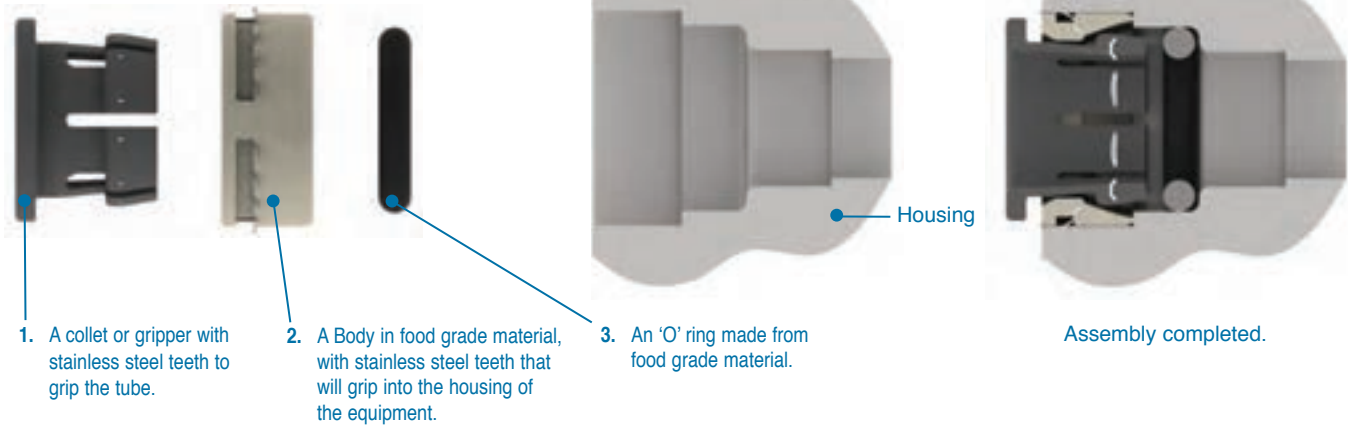

With the cartridge in its normal position the stainless steel teeth sink into the housing to a depth dependent upon the hardness of the housing material used.

When the system is under pressure the cartridge is held firmly in the body by the stainless steel teeth. These will sink in further as more pressure is applied.

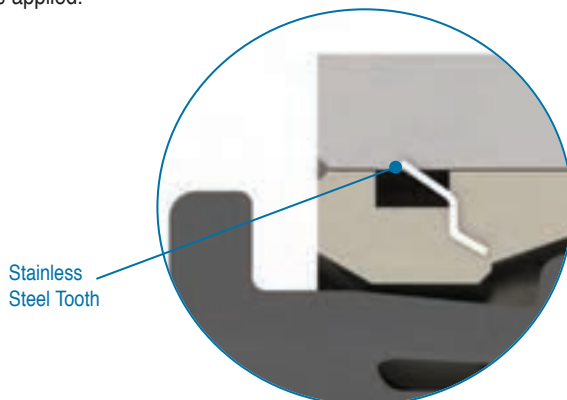

Tube OD Size Plastic Half Cartridges

Plastic Half Cartridges have been designed to provide a simple, cost-effective method of integrating the **Super Speedfit®** technology into a wide variety of original equipment. The cartridge requires low insert loads, making it suitable for many different housing materials.

Plastic Half Cartridges consist of three components: a collet gripper, an O-ring of food grade materials and a plastic body with stainless steel teeth molded into the circumference.

Customers should ensure cartridges are suitable for their applications, materials and operating conditions.

For additional information consult our Technical Support Department.

Prices are subject to change without notice.

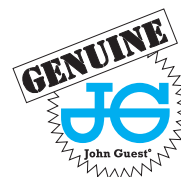

INCH SERIES



GRAY ACETAL COLLET
GRAY ACETAL BODY
NITRILE O-ring

PART NO.	TUBE OD	BOX QTY
PM2804S	5/32"	1000
PI2806S	3/16"	1000
PI2808S	1/4"	1000
PM2808S	5/16"	1000
PI2812S	3/8"	1000
PI2816S	1/2"	500

Most sizes available with Blue, Red or White Collet, suffix B, R or W (Ex. PI2808S-B). Also available with double O-rings, please use suffix 2 (Ex. PI2808S2).



GRAY ACETAL COLLET
GRAY ACETAL BODY
EPDM O-ring

PART NO.	TUBE OD	BOX QTY
PCI2808S	1/4"	1000
PCM2808S	5/16"	1000
PCI2812S	3/8"	1000
PCI2816S	1/2"	500



WHITE POLYPROPYLENE COLLET
WHITE POLYPROPYLENE BODY
EPDM O-ring

PART NO.	TUBE OD	BOX QTY
PP2808W	1/4"	1000
PP2812W	3/8"	1000



WHITE ACETAL COLLET
WHITE ACETAL BODY
NITRILE O-ring

PART NO.	TUBE OD	BOX QTY
PI2808W	1/4"	1000
PM2808W	5/16"	1000
PI2812W	3/8"	1000

Also available with Blue or Red Collet, suffix B or R (Ex. PI2808W-B). Also available with double o-rings, please use suffix 2 (Ex. PI2808W2).



BLACK POLYPROPYLENE COLLET
BLACK POLYPROPYLENE BODY
EPDM O-ring

PART NO.	TUBE OD	BOX QTY
PP2808E	1/4"	1000
PP2812E	3/8"	1000

HALF CARTRIDGE KIT



GRAY ACETAL COLLET
GRAY ACETAL BODY

PART NO.	TUBE OD	BOX QTY
NC2007-02S	1/4"	1000
NC2007-03S	5/16"	1000
NC2007-04S	3/8"	1000

METRIC SERIES



BLACK ACETAL COLLET
BLACK ACETAL BODY
NITRILE O-ring

PART NO.	TUBE OD	BOX QTY
PM2806E	6mm	1000
PM2808E	8mm	1000
PM2810E	10mm	1000

Also available with double o-rings, please use suffix 2 (Ex. PM2806E2).

CTS Size Plastic Half Cartridges

John Guest Copper Tube Size Plastic Half Cartridges have been designed for use in Plumbing, Recreational Vehicle and Marine Applications.

Half Cartridge bodies and collets are produced from high quality Engineered Thermoplastic materials with EPDM O-rings.

INCH SERIES



PART NO.	CTS	BOX QTY
PCI2820	1/2"	200
PCI2828	3/4"	100

CTS Cartridge incorporate a spacer and an o-ring.

Tube OD Size Metal Half Cartridges

Metal Half Cartridges are designed with the same Super Speedfit® technology as our Plastic Half Cartridges. As with Plastic Half Cartridges, Metal Half Cartridges are designed to provide a simple, cost-effective method of securing tubing into taps, manifolds, flow direction splitters and many other types of components, which can be produced in a wide variety of metals.

Metal Half Cartridges consist of three components: a collet gripper, an O-ring of food grade materials, and a metal body.

Customers should ensure cartridges are suitable for their applications, materials and operating conditions.

For additional information consult our Technical Support Department.

Prices are subject to change without notice.

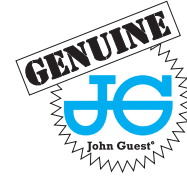

INCH SERIES



GRAY ACETAL COLLET
BRASS BODY
NITRILE O-ring

PART NO.	TUBE OD	BOX QTY
MM2804N	5/32"	1000
MI2806N	3/16"	1000
MI2808N	1/4"	1000
MM2808N	5/16"	1000
MI2812N	3/8"	1000
MI2816N	1/2"	500

Also available with double O-rings, please use suffix 2 (Ex. MM2804N2)



GRAY ACETAL COLLET
STAINLESS STEEL BODY
NITRILE O-ring

PART NO.	TUBE OD	BOX QTY
MI2806ST	3/16"	1000
MI2808ST	1/4"	1000
MM2808ST	5/16"	1000
MI2812ST	3/8"	1000



BLACK ACETAL COLLET ON 8MM
GRAY ACETAL COLLET ON 15 AND 22MM
BRASS BODY
EPDM O-ring

PART NO.	TUBE OD	BOX QTY
CM2808N	8mm	1000
CM2815N	15mm	300
CM2822N	22mm	100

METRIC SERIES

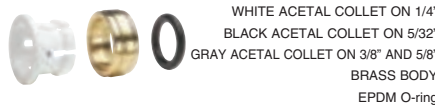

WHITE ACETAL COLLET ON 1/4"
BLACK ACETAL COLLET ON 5/32"
GRAY ACETAL COLLET ON 3/8" AND 5/8"
BRASS BODY
EPDM O-ring

PART NO.	TUBE OD	BOX QTY
CM2804N	5/32"	1000
CI2808W	1/4"	1000
CI2812N	3/8"	1000
CI2820N	5/8"	1000



BLACK ACETAL COLLET ON 5, 6, 10 AND 12MM
GRAY ACETAL COLLET ON 4 AND 8MM
BRASS BODY
NITRILE O-ring

PART NO.	TUBE OD	BOX QTY
MM2804N	4mm	1000
MM2805N	5mm	1000
MM2806N	6mm	1000
MM2808N	8mm	1000
MM2810N	10mm	1000
MM2812N	12mm	500

Also available with double O-rings, please use suffix 2 (Ex. MM2804N2)

CTS Size Metal Half Cartridges

CTS size Metal Half Cartridges have also been designed for use in Plumbing, Recreational Vehicle and Marine Applications.

Bodies are produced from brass, Collets from high quality Engineered Thermoplastic materials with EPDM O-rings.

INCH SERIES



PART NO.	CTS	BOX QTY
MWI2820	1/2"	250
MWI2828	3/4"	100
MWI2836	1"	100

CTS Cartridge incorporate a spacer and an o-ring.

John Guest® Half Cartridges

CARTRIDGE ASSEMBLY

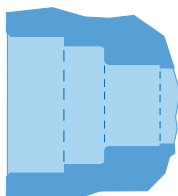

1. Ensure that the cavity is clean and free from debris, burrs, score marks, etc.

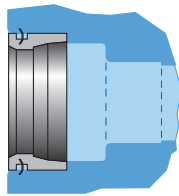

2. Insert the cartridge down into the housing; ensure the cartridge is flush with the housing.

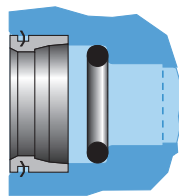

3. Insert the O-ring.

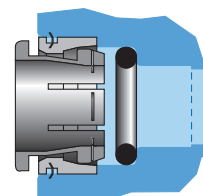

4. Insert Collet to complete assembly.

Inch

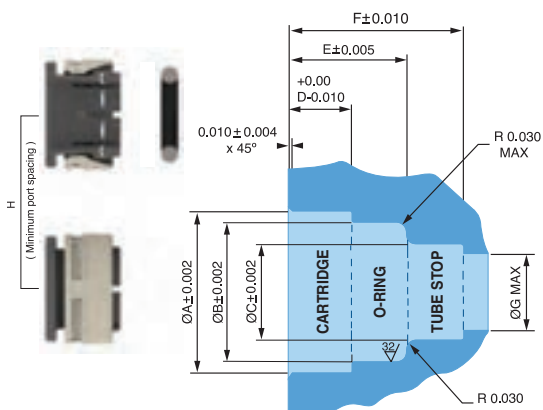

Cavity Dimensional Detail (Inch)

Tube OD	ØA	ØB	ØC	D	E1	E2	F1	F2	ØG	H
5/32" *	0.492	0.327	0.163	0.193	0.350	0.445	0.504	0.598	0.13	0.59
5/32" **	0.472	0.327	0.163	0.193	0.350	0.445	0.504	0.598	0.13	0.59
3/16"	0.472	0.348	0.193	0.193	0.340	0.440	0.490	0.590	0.16	0.59
1/4"	0.528	0.424	0.255	0.181	0.386	0.480	0.555	0.650	0.23	0.67
5/16"	0.544	0.470	0.320	0.215	0.400	0.500	0.590	0.690	0.29	0.67
3/8"	0.632	0.547	0.380	0.270	0.465	0.565	0.720	0.815	0.35	0.79
1/2"	0.777	0.671	0.506	0.304	0.561	0.659	0.797	0.896	0.48	0.93
5/8"	0.935	0.836	0.638	0.335	0.703	-	1.093	-	0.50	1.06

All dimensions in inches

* - Metal Half Cartridges.

** - Plastic Half Cartridges.

E1 and F1 relate to one o-ring.

E2 and F2 relate to two o-rings.

Cavity Dimensional Detail (CTS)

Tube OD	ØA	ØB	ØC	D	E1	E2	F1	F2	ØG	H
1/2" CTS*	0.935	0.836	0.638	0.335	0.693	-	1.057	-	0.546	1.060
1/2" CTS**	0.967	0.836	0.638	0.392	0.693	-	1.057	-	0.546	1.060
3/4" CTS*	1.222	1.102	0.886	0.427	0.831	-	1.362	-	0.776	1.358
3/4" CTS**	1.222	1.102	0.886	0.447	0.831	-	1.362	-	0.776	1.358
1" CTS*	1.480	1.398	1.141	0.429	0.791	-	1.386	-	1.003	1.628

Metric

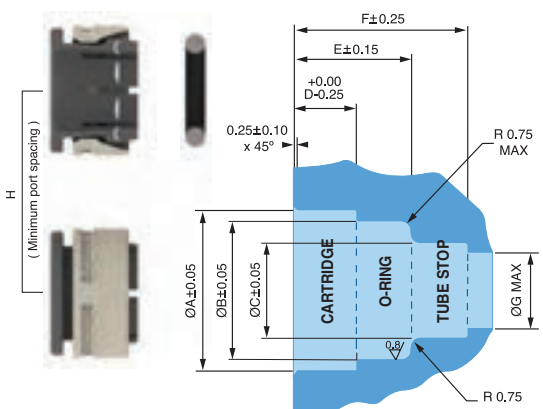

Cavity Dimensional Detail (Metric)

Tube OD	ØA	ØB	ØC	D	E1	E2	F1	F2	ØG	H
4mm *	12.50	8.30	4.14	4.90	8.90	11.30	12.80	15.20	3.30	15.0
4mm **	11.98	8.30	4.14	4.90	8.90	11.30	12.80	15.20	3.30	15.0
5mm	11.98	9.06	5.13	4.90	8.63	11.17	12.44	14.98	4.30	15.0
6mm	13.41	10.00	6.12	4.60	9.80	12.20	14.00	16.50	5.30	16.5
8mm	13.82	11.94	8.13	5.46	10.15	12.70	15.00	17.50	7.40	17.0
10mm	16.05	14.00	10.15	6.86	11.81	14.35	18.17	20.71	9.20	19.0
12mm*	19.10	16.54	12.15	8.65	15.50	19.00	23.50	27.00	11.20	22.0
12mm**	19.74	16.54	12.15	7.72	15.90	-	23.90	-	11.20	24.0
15mm	22.86	20.32	15.19	9.50	17.50	21.00	26.90	30.40	14.20	27.0
22mm	31.05	27.80	22.20	10.85	21.10	24.70	31.60	35.20	21.20	34.5

All dimensions in mm

* - Metal Half Cartridges.

** - Plastic Half Cartridges.

E1 and F1 relate to one o-ring.

E2 and F2 relate to two o-rings.

PI to PP Cross Reference Chart

DESCRIPTION PI: ACETAL-GRAY PP: POLYPRO-WHITE

MALE CONNECTOR NPTF THREAD

1/4 - 1/8	PI010821S	PP010821W
1/4 - 1/4	PI010822S	PP010822W
1/4 - 3/8	PI010823S	PP010823W
3/8 - 1/4	PI011222S	PP011222W
3/8 - 3/8	PI011223S	PP011223W
3/8 - 1/2	PI011224S	PP011224W
1/2 - 3/8	PI011623S	PP011623W
1/2 - 1/2	PI011624S	PP011624W

UNION TEE

1/4	PI0808S	PP0208W
5/16	PM00208S	PPM0208W
3/8	PI0212S	PP0212W
1/2	PP0216S	PP0216W

UNION ELBOW

1/4	PI0308S	PP0308W
5/16	PM0308S	PPM0308W
3/8	PI0312S	PP0312W
1/2	PI0316S	PP0316W
1/4	PI0308S-B	PP0308W-B

STEM ADAPTER NPTF THREAD

1/4 x 1/8	PI050821S	PP050821W
1/4 x 1/4	PI050822S	PP050822W
3/8 x 1/4	PI051222S	PP051222W
3/8 x 3/8	PI051223S	PP051223W
1/2 x 3/8	PI051623S	PP051623W
1/2 x 1/2	PI051624S	PP051624W

REDUCER

3/8 - 1/4	PI061208S	PP061208W
1/2 - 3/8	PI061612S	PP061612W

PLUG

1/4	PI0808S	PP0808W
5/16	PM0808S	PPM0808W
3/8	PI0812S	PP0812W
1/2	PI0816S	PP0816W

SWIVEL ELBOW NPTF THREAD

1/4 x 1/8	PI090821S	PP090821W
1/4 x 1/4	PI090822S	PP090822W
3/8 x 1/4	PI091222S	PP091222W
3/8 x 3/8	PI091223S	PP091223W

UNION CONNECTOR

1/4	PI0408S	PP0408W
5/16	PM0408S	PPM0408W
3/8	PI0412S	PP0412W
1/2	PI0416S	PP0416W

SWIVEL BRANCH TEE CENTER LEG

1/4 x 1/8	PI100821S	PP100821W
1/4 x 1/4	PI100822S	PP100822W
3/8 x 1/4	PI101222S	PP101222W
3/8 x 3/8	PI101223S	PP101223W

DESCRIPTION PI: ACETAL-GRAY PP: POLYPRO-WHITE

SWIVEL MALE RUN TEE NPTF THREAD

1/4 x 1/8	PI110821S	PP110821W
1/4 x 1/4	PI110822S	PP110822W
3/8 x 1/4	PI111222S	PP111222W
3/8 x 3/8	PI111223S	PP111223W

BULKHEAD UNION

1/4 0.67	PI1208S	PP1208W
3/8 0.83	PI1212S	PP1212W
1/2 1.06	PI1216S	PP1216W

REDUCING BULKHEAD UNION

3/8 - 1/4 0.83	PI121208S	PP121208W
----------------	-----------	-----------

REDUCING UNION CONNECTOR

3/8 - 1/4	PI201208S	PP201208W
1/2 - 3/8	PI201612S	PP201612W

REDUCING ELBOW

5/16 - 1/4	PI211008S	PP211008W
3/8 - 1/4	PI211208S	PP211208W
1/2 - 3/8	PI211612S	PP211612W

PLUG IN ELBOW

1/4 - 1/4	PI220808S	PP220808W
5/16 - 5/16	PM220808S	PPM220808W
3/8 - 1/4	PI221208S	PP221208W
3/8 - 3/8	PI221212S	PP221212W
1/2 - 1/2	PI221616S	PP221616W
3/8 - 3/8	PI221212S-B	PP221212W-B

TWO WAY DIVIDER

3/8	PI2312S	PP2312W
-----	---------	---------

TUBE TO HOSE STEM

3/8 - 3/8	PI251212S	PP251212W
3/8 - 1/2	PI251216S	PP251216W
1/2 - 3/8	PI251612S	PP251612W
1/2 - 1/2	PI251616S	PP251616W

REDUCING TEE

3/8 x 3/8 x 1/4	PI30121208S	PP30121208W
1/2 x 1/2 x 3/8	PI301612S	PP301612W

FAUCET CONNECTOR UNS THREAD

1/4 x 7/16 - 24	PI3208U7S	PP3208U7W
3/8 x 7/16 - 24	PI3212U7S	PP3212U7W

FEMALE ADAPTER NPTF THREAD

1/4 x 1/4	PI450822S	PP450822W
3/8 x 1/4	PI451222S	PP451222W

FIXED ELBOW NPTF THREAD

1/4 x 1/8	PI480821S	PP480821W
1/4 x 1/4	PI480822S	PP480822W
1/4 x 3/8	PI480823S	PP480823W
3/8 x 1/4	PI481222S	PP481222W
3/8 x 3/8	PI481223S	PP481223W

Working Pressure and Temperature Range for Acetal Fittings (PI, SI, SM and PM Range).

Super Speedfit® fittings are suitable for the following pressures and temperatures.

Temp.	Pressure	
	5/32" - 5/16"	3/8" - 1/2"
	4mm - 8mm	10mm - 22mm
Air		
- 4°F	230 psi	150 psi
Potable Liquids and Air		
+33°F	230 psi	150 psi
+68°F	230 psi	150 psi
+150°F	150 psi	100 psi

Also suitable for vacuum

For Polypropylene Working Pressure and Temperature Range, please refer to page 5.

Depending on the tube used, under certain conditions fittings may be used at higher pressures and temperatures. Please refer to our Technical Support Department for guidance. Note 1 Bar = 14.5 PSIG.

Tube Types

Plastic Tube - Polyethylene, nylon and polyurethane conforming to the tolerances shown below. For soft tubing or thin wall tube we recommend the use of tube inserts.

Braided Tube - Use of Tube to Hose Stems listed on page 9 is essential when using braided tube or hose. The use of clamps to retain braided tube on barbs is recommended.

Metal Tube (soft) - Brass, copper or mild steel conforming to the tolerances below.

Metal Tube (hard) - We do not recommend Super Speedfit fittings for hard metal or chrome plated tubes.

For stainless steel and other polished metal tubes we recommend the use of Superseal fittings. These are shown on page 14 of this catalog.

It is essential that outside diameters be free from score marks and that the tube be deburred before inserting the fitting.

Tube Tolerances

Super Speedfit® fittings are offered for tubes with outside diameters to the following tolerances.

Size (inches)	5/32 - 3/16	1/4 - 1/2
Tolerance (inches)	+0.001 / -0.003	+0.001 / -0.004
Size (mm)	4mm - 5mm	6mm - 22mm
Tolerance (mm)	+0.05 / -0.07	+0.05 / -0.10

Installation and System Testing

Fittings and tube should be kept clean and undamaged before use.

All tube and fittings installations must be pressure tested after installation to ensure system integrity before handing over to the final user. Refer to "How to make a connection".

Chemicals

For use with chemicals or other potentially aggressive

liquids, please contact our Technical Support Department.

Super Speedfit fittings are not recommended for use with explosive gases, petroleum spirits, and other fuels or for central heating systems.

Collet Covers

Are available as additional security against removal of the tube or to provide a simple means of color coding. The cover is offered in a range of six colors. Please see page 23 of this catalog.

Food Quality



All the fittings in this catalog are produced in Food and Drug Administration (FDA) approved materials and are therefore recommended for food quality applications.

The wetted surfaces of John Guest PI, PM, SI, SM, CI, CM and NC plastic fittings, PPSV and ASV Valves, and PE Tubing are in compliance with FDA requirements for direct contact with food as detailed in 21CFR part 177.2470 for the body and 177.2600 for the O-ring.

NSF International Standard 51 and 61.

Maximum Torque Values for Plastic Threads BSP, BSPT & NPT.

Do not overtighten plastic threaded fittings as this could cause undue stress and eventual failure. Maximum recommended torque figures are shown below.

	Threads		
	1/8" - 1/4"	3/8" - 1/2"	3/4"
Maximum Torque	1.0ft lbs 1.5Nm	2ft lbs 3.0Nm	3ft lbs 4.0Nm

John Guest recommends that OEM customers consider replacing threaded ports with the more modern Cartridge Systems.

It is recommended that all installations are checked prior to use to determine that a seal has been made.

The maximum torque figures quoted for use with Speedfit fittings are dependent on the mating thread conforming to the relevant U.S., British or International thread standard.

Maintenance and Replacement Intervals

John Guest products generally require little maintenance but as a minimum we recommend routine visual inspection. Frequency of visual inspection will depend on severity of application and risk of failure. If after visual inspection John Guest products appear damaged, cracked, charred, discolored, heat distorted or corroded, they should be replaced. Any product that is or appears to be leaking should be replaced.

Product life is affected by the severity of the application, the hostility of the working environment and contact with aggressive chemicals or liquids. It is therefore important that specific replacement intervals be considered by specifiers/users/customers based on previous service life or when failure could result in unacceptable downtime, damage or injury risk.

Cleaners and Sanitizing of Fittings

The external surfaces of John Guest products must not come into contact with oxidizing or acidic cleaners and sanitizing agents, for example (but not limited to) those below pH 4, high in sodium hypochlorite

level (bleach) or containing hydrogen peroxide. Our plastic material suppliers recommend ECOLAB Oasis 133 as a suitable cleaner for the external surfaces of products manufactured by John Guest. Several different methods exist for sanitizing the internal surfaces of fluid systems, including sodium hypochlorite, hydrogen peroxide, chlorine dioxide or ozone. It is entirely the responsibility of the end user to determine if the chosen method is suitable for use with John Guest products over the planned working life of the system. However, to avoid unnecessary early failure, John Guest requires that the disinfection solution must be immediately flushed out at all draw off points with fresh, wholesome water at the end of the disinfection period. **The solution must not be left in the system.** Disinfection solutions must only come into contact with the internal (fluid carrying) surfaces of the system. If any other surfaces of a fitting come into contact with disinfection solution **the whole fitting must be replaced immediately.** Polypropylene fittings offer greater resistance to aggressive chemicals but does not have the same mechanical properties as other materials. John Guest polypropylene fittings are generally designated by the part number prefix PP or PPM.

Our material suppliers recommend ECOLAB Oasis 133 as a suitable external cleaner for products manufactured by John Guest.

Responsibility of Use

While we give a warranty against defects in manufacture or materials, it is the responsibility of the user/installer to ensure that fittings and related products are suitable for their application. The installation must be carried out correctly in accordance with our recommendations, complying with recognized codes of practice and relevant national standards, and be properly maintained. Please refer to our terms and conditions of sale.

Side Load

Fittings should not be subject to excessive side loads and they should not be used as support brackets. Tubing and fittings should be adequately supported to prevent excessive side loading.

Product Selection and Installation

John Guest fittings and related products are specifically designed and manufactured by John Guest to the Technical Specifications set out in the John Guest Product Catalog. All John Guest fittings and related products should be selected, installed, used and maintained in accordance with these Technical Specifications. It is the customer's/user's responsibility to ensure that John Guest fittings and related products are suitable for their intended applications, and are properly installed and maintained and are used in accordance with the Technical Specifications. It is also the customer's/user's responsibility to provide its customers with any relevant technical information about John Guest products it supplies them.

The company has a policy of continuous research and development and reserves the right to amend without notice the specification and design of all products illustrated in this catalog. John Guest reserves the right to change the color and shape of products. Photographs are for illustration purposes only.

Subject to our Terms and Conditions of Sale shown on page 36-37.

John Guest USA, Inc. is not responsible for misprints or typographical errors.

CTS JG TWIST & LOCK® FITTINGS



Lead Free

The PEI Range of JG Twist & Lock® Fittings is offered in 1/2", 3/4" and 1" CTS sizes. The fittings are manufactured from high quality engineered plastic with EPDM O-Rings. Speedfit Push-in System is suitable for hot and cold water plumbing applications.

Detailed Technical Information shown on page 36.

Prices subject to change without notice.

TEE



PART NO.	SIZE CTS	BAG QTY	BOX QTY
PEI0220	1/2"	5	25
PEI0228	3/4"	2	10
PEI0236	1"	1	5

ELBOW



PART NO.	SIZE CTS	BAG QTY	BOX QTY
PEI0320	1/2"	5	40
PEI0328	3/4"	5	20
PEI0336	1"	1	10

REDUCING ELBOW



PART NO.	SIZE CTS	BAG QTY	BOX QTY
PEI212820	3/4" X 1/2"	5	25
PEI213628	1" X 3/4"	1	10

COUPLER



PART NO.	SIZE CTS	BAG QTY	BOX QTY
PEI0420	1/2"	5	40
PEI0428	3/4"	5	25
PEI0436	1"	1	15

REDUCER



PART NO.	SIZE STEM x CTS	BAG QTY	BOX QTY
PEI062820	3/4" x 1/2"	10	50
PEI063628	1" x 3/4"	5	30

REDUCING COUPLER



PART NO.	SIZE CTS	BAG QTY	BOX QTY
PEI202820	3/4" x 1/2"	5	30
PEI203628	1" x 3/4"	5	15

STEM ELBOW



PART NO.	SIZE STEM x CTS	BAG QTY	BOX QTY
PEI222020	1/2" x 1/2"	10	60
PEI222828	3/4" x 3/4"	5	25

REDUCING TEE



PART NO.	SIZE CTS	BAG QTY	BOX QTY
PEI3028A	3/4" x 3/4" x 1/2"	5	15
PEI3028B	3/4" x 1/2" x 1/2"	5	20
PEI3028C	1/2" x 1/2" x 3/4"	5	20
PEI3028D	3/4" x 1/2" x 3/4"	5	15
PEI3036A	1" x 1" x 3/4"	1	10

Sizes are listed in the following order

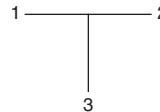

FEMALE CONNECTOR



PART NO.	SIZE CTS X NPS	BAG QTY	BOX QTY
PSEI452826	3/4" x 3/4"	5	40
PEI452034	1/2" x 1/2"	5	50

STACKABLE TEE



PART NO.	SIZE CTS	BAG QTY	BOX QTY
PEI532020	1/2" x 1/2" x 1/2"	5	30
PEI532820	3/4" x 3/4" x 1/2"	5	20
PEI532828	3/4" x 3/4" x 3/4"	1	15

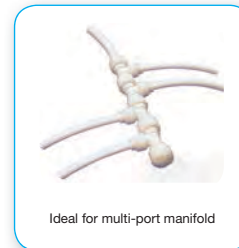

SLIP CONNECTOR/BURST PIPE REPAIR FITTING



PART NO.	SIZE CTS	BAG QTY	BOX QTY
1/2SCP	1/2"	1	5
3/4SCP	3/4"	1	5

A quick and easy method of replacing burst or damaged pipe without the need to alter existing pipe work.

TEE INSTALLATION KIT



PART NO.	SIZE CTS	BAG QTY	BOX QTY
1/2TKP	1/2"	1	5
3/4TKP	3/4"	1	5

Note Tee Installation Kits do not have IAPMO or ICC approval.

Provides a simple method of breaking into and branching off a rigid run without altering existing pipe work.

END CAP



PART NO.	SIZE	BAG QTY	BOX QTY
PSEI4620	1/2"	10	150
PSEI4628	3/4"	5	80
PEI4636	1"	5	30



PSEI4620B (Blue)	1/2"	10	150
PSEI4620R (Red)	1/2"	10	150
PSEI4628B (Blue)	3/4"	5	80
PSEI4628R (Red)	3/4"	5	80

NEW FEMALE CONNECTOR



PART NO.	SIZE O.D. X UNEF	BAG QTY	BOX QTY
PSEI6012U9	3/8" x 9/16"-24	10	200

9/16 - 24 UNEF = 3/8 Compression Threads

FEMALE SWIVEL CONNECTOR



PART NO.	SIZE CTS x NPS	BAG QTY	BOX QTY
PEI2TC2034	1/2" x 1/2"	10	50

Hand tighten only, no spanner required

FEMALE SWIVEL ELBOW



PART NO.	SIZE CTS x NPS	BAG QTY	BOX QTY
PEIBTC2034	1/2" x 1/2"	10	50

Hand tighten only, no spanner required

FEMALE BALLCOCK CONNECTOR



PART NO.	SIZE CTS x UNS	BAG QTY	BOX QTY
PEI2TC20C75	1/2" x 7/8" - 15/16"	10	50

Connects to toilet fill valve.

Hand tighten only, no spanner required

NEW FEMALE SWIVEL ELBOW (GARDEN HOSE THREAD)



PART NO.	SIZE O.D. X NH	BAG QTY	BOX QTY
NC2723	3/8" x 3/4"-11.5	5	70

FEMALE BALLCOCK ELBOW



PART NO.	SIZE CTS x UNS	BAG QTY	BOX QTY
PEIBTC20C75	1/2" x 7/8" - 15/16"	10	50

Connects to toilet fill valve.

Hand tighten only, no spanner required

MALE CONNECTOR



PART NO.	SIZE CTS x NPT	BAG QTY	BOX QTY
PSEI012024	1/2" x 1/2"	10	80
PSEI012026	1/2" x 3/4"	5	60
PSEI012826	3/4" x 3/4"	5	50
PSEI013626	1" x 3/4"	2	30
PSEI013628	1" x 1"	2	20

MALE FIXED ELBOW



PART NO.	SIZE CTS	BAG QTY	BOX QTY
PSEI482024	1/2" x 1/2"	5	60

SHUT OFF VALVE •



PART NO.	SIZE CTS x CTS	BAG QTY	BOX QTY
PSEISV20P	1/2"	1	100
PSEISV28P	3/4"	1	75

Firm 1/4 turn handle, prevents unwanted movement. Includes indicator arrow showing off position and 2 interchangeable buttons for color coding hot & cold water.

NEW LEAD FREE BRASS PRODUCTS

FOR USE WITH COPPER, PEX AND CPVC PIPE



• Dezincification Resistant

Lead Free BRASS MALE CONNECTOR



PART NO. NSF 61	SIZE CTS x NPT	BAG QTY	BOX QTY
MWI012024LF	1/2" x 1/2"	5	100
MWI012026LF	1/2" x 3/4"	5	100
MWI012826LF	3/4" x 3/4"	5	50

Lead Free BRASS MALE STEM ADAPTER



PART NO.	SIZE CTS x NPT	BAG QTY	BOX QTY
MWI052024LF	1/2" x 1/2"	10	100
MWI052826LF	3/4" x 3/4"	1	40

STANDARD BRASS

WING BACK ELBOW



PART NO.	SIZE CTS x NPT	BAG QTY	BOX QTY
WBI2024	1/2" x 1/2"	1	20

Not for potable water applications.

BLACK CTS JG TWIST & LOCK® FITTINGS



The Black PEI Range of Twist & Lock Fittings is offered in 3/4" and 1" CTS sizes. They have been specifically designed for Water Filtration/Softener Installs; however, they are also suitable for Marine and R.V. applications. The fittings are manufactured from high quality engineered plastic with EPDM O-rings. Speedfit Push-in system is suitable for hot and cold water plumbing applications.

Detailed Technical Information shown on page 36.
Prices subject to change without notice. Not Suitable for gas.

CONNECTOR



PART NO.	SIZE CTS	BAG QTY	BOX QTY
PEI0428E	3/4"	5	25
PEI0436E	1"	1	15

ELBOW



PART NO.	SIZE CTS	BAG QTY	BOX QTY
PEI0328E	3/4"	5	20
PEI0336E	1"	1	10

TEE



PART NO.	SIZE CTS	BAG QTY	BOX QTY
PEI0228E	3/4"	2	10
PEI0236E	1"	5	5

PLUG IN ELBOW



PART NO.	SIZE CTS x STEM	BAG QTY	BOX QTY
PEI222828E	3/4" x 3/4"	5	25
PEI223636E	1" x 1"	10	25

MALE CONNECTOR



PART NO.	SIZE CTS x NPT	BAG QTY	BOX QTY
PSEI012024E	1/2" x 1/2"	10	80
PSEI012026E	1/2" x 3/4"	5	60
PSEI012826E	3/4" x 3/4"	5	50
PSEI013626E	1" x 3/4"	2	30
PSEI013628E	1" x 1"	2	20

Only to be used with mating plastic threads.

MALE STEM ADAPTER



PART NO.	SIZE CTS x NPT	BAG QTY	BOX QTY
PSEI052826E	3/4" x 3/4"	10	60
PSEI053628E	1" x 1"	10	40

Only to be used with mating plastic threads.

NEW SHUT-OFF VALVE



PART NO.	SIZE CTS x CTS	BAG QTY	BOX QTY
PSEISV28EP	3/4"	1	75

Firm 1/4 turn handle, prevents unwanted movement. Includes indicator arrow showing off position and 2 interchangeable buttons for color coding hot and cold water.

The Brand Most Trusted by Water Professionals Worldwide



Working Pressures and Temperatures:

Application: Water

Max. Pressure	Max Temperature
160 psi	73°F
100 psi	180°F
80 psi	200°F

Do not use with gas, fuel oil or compressed air applications.

MALE FIXED ELBOW



PART NO.	SIZE CTS x NPT	BAG QTY	BOX QTY
----------	----------------	---------	---------

PSEI482024E 1/2" x 1/2" 5 60
 Only to be used with mating plastic threads.

NEW FEMALE CONNECTOR

NPS THREADS



PART NO.	SIZE CTS x NPS	BAG QTY	BOX QTY
----------	----------------	---------	---------

PSEI622838E 3/4" x 1" TBA TBA
 PSEI62363AE 1" x 1 1/4" TBA TBA
 Hand tighten only for plastic mating threads.

NEW FEMALE ELBOW CONNECTOR

NPS THREADS



PART NO.	SIZE CTS x NPS	BAG QTY	BOX QTY
----------	----------------	---------	---------

PSEI632838E 3/4" x 1" TBA TBA
 PSEI63283AE 3/4 x 1 1/4" TBA TBA
 PSEI63363AE 1 x 1 1/4" TBA TBA
 Hand tighten only for plastic mating threads.

STEM ELBOW



PART NO.	SIZE CTS x STEM
----------	-----------------

* 3/4" x 1 1/4"

STEM CONNECTOR



PART NO.	SIZE CTS x STEM
----------	-----------------

* 1" x 1 1/4"

*Available through Clack Distributors.

REDUCER COUPLER



PART NO.	SIZE CTS	BAG QTY	BOX QTY
----------	----------	---------	---------

PEI203628E 1" x 3/4" 5 15



Flexi Hoses

The PSFC Range of push-fit flexi hose have been designed for the connection of plastic and copper pipe, for use in a variety of applications including water softener and water heater installations. Hoses are offered in 3/4" and 1/2" CTS x 3/4" NPSM male threads x 18" long. Hoses are double crimped for greater reliability.

Flexi hoses provide fast and easy installations, they are corrosion resistant, lead-free compliant.

Working Pressures and Temperatures

Water Max. 125 psi, Min. 20 psi
Max. 60°F, Min 40°F

Prices are subject to change without notice.



BRASS FLARE FEMALE CONNECTOR



ASSE A.112.18.6-2009
CSA B125.6-2009



PART NO.	CTS	NPSM	LENGTH	BAG QTY	BOX QTY
PSFC28N3618E	3/4	x 3/4	x 18"	1	200
PSFC20N3618E	1/2	x 3/4	x 18"	1	200

PART NO.	CTS	CTS	LENGTH	BAG QTY	BOX QTY
PSFC28C2818E	3/4	x 3/4	x 18"	1	100

Speedfit® Technical Checklist

CTS - SPEEDFIT TWIST & LOCK® (PEI AND PSEI RANGE) FOR PRODUCTS LISTED ON PAGES 32-34.

Fittings and pipe should be kept clean and undamaged before use.

- **Sizes:** 1/2" to 1" CTS.
- **Pipes:** Speedfit fittings can be used with: PEX, Copper and CPVC Pipes conforming to ASTM Standards. Speedfit fittings cannot be used on stainless steel pipe.
- **Standards:** Speedfit products are designed and manufactured under a fully integrated system assessed by B.S.I. to BS EN ISO9001. Speedfit PEI and PSEI Fittings and Speedfit PEX Pipe are also NSF-14 and NSF-61, IAPMO and ICC listed.
- **Do not use for gas, fuel oil or compressed air applications.**
- **Working pressures and temperatures:**

Application	Max. Pressure	Max. Temperature
Water	160 psi	73° F
Water	100 psi	180° F
Water	80 psi	200° F

- **Burst Pressure (fittings):** Speedfit fittings used with copper or Speedfit PEX Pipe will withstand pressures well in excess of normal service conditions.
- **Insulation:** Comply with code requirements.
- **Minimum bend radius (PEX):**

Pipe Diameter	1/2" CTS	3/4" CTS
Min radius	7"	9"

- **Clip spacing (in inches):**
For surface mounted pipes.

Clip Spacing		
Pipe Diameter	Horizontal Run	Vertical Run
1/2" CTS	16"	20"
3/4" CTS	20"	30"
1" CTS	30"	36"

- **Expansion (PEX Pipe):** 1% on length between 68°F and 180°F.
- **Flow rates:** Comparable with metal systems.
- **Cleaners, inhibitors and descalants:** For advice on the use of additives such as corrosion inhibitors, the additive manufacturers should be consulted.
- **Paint and Chemicals.** Only use water or oil based paint. **DO NOT ALLOW CONTACT WITH** cellulose based paints, paint thinners or strippers, solder flux or acid based descalants or aggressive household cleaning products.
- **Solder Flux:** No fluxes of any type should come into contact with Speedfit products. Extreme care should be taken to ensure that no such contact takes place.
- **Chlorine.** Speedfit® is suitable for use with water supplies containing up to 4ppm of chlorine.
- **Exposure to light:** Speedfit products, when used indoors, are not affected by sunlight. When used outdoors, protect from ultraviolet light by lagging or painting.
- **Pipe clips:** Pipe clips should not be fitted any closer than 2.5 inches from the end of the fitting. Pipe should be adequately supported by pipe clips to prevent undue stress (side load) on fittings.
- **Pipe inserts: Plumbing:** John Guest recommends the use of pipe inserts for PEX pipe connections with John Guest Speedfit products in Standard Residential Plumbing (hot and cold water) installations.

Pipe inserts: Heating: John Guest requires the use of pipe inserts for PEX pipe connections with John Guest Speedfit products in all Heating installations.

- **Metal joists:** When 'cabling' plastic pipe through metal joists, ensure rubber grommets are in place to prevent damage to the pipe.
- **Connection to boilers:** A minimum 36 inches run of copper pipe must be installed between the hot water heater and the Speedfit system.
- **Connection to Hot Water Heater:** A minimum 18 inches run of copper pipe must be installed between the hot water heater and the Speedfit System.
- **Connection to copper pipe:** 18 inches is the minimum distance to make a solder connection on copper pipe inserted into a Speedfit fitting. Ensure that no solder flux comes into contact with the fitting.
- **Concrete and masonry:** Speedfit pipe and fittings can be laid in concrete and masonry providing they are installed in conduit pipe with access boxes for the fittings. This is to enable the pipe to expand and provide accessibility for both pipe and fittings. Fittings and pipe should be removable for possible replacement. Insulation is also recommended to protect against heat loss and the effects of frost. Fittings not to be used underground.
- **Electrical continuity:** If Speedfit is used in an existing metal system, electrical continuity must be reinstated.
- **Disinfection of Hot and Cold Water Systems.** Speedfit® can be disinfected after installation or as part of a routine maintenance program. The disinfection procedure must comply with code requirements. Only disinfection solutions specifically recommended as suitable for contact with plastic plumbing systems and, where necessary, employing specialist contractors may be used with Speedfit®.
- **System testing:** To ensure the pipework and fittings have been installed correctly, whether it be on a new or extended system, it is essential that the system be checked and hydraulically wet tested. Testing should be at 30 psi for 10 minutes and 150 psi for 10 minutes. This testing, combined with other relevant checks, should reveal installation problems and is regarded as good plumbing practice. However, system testing should not be regarded as a substitute for correct installation (see also "Making a Good Connection").
- **System flushing:** As is usual practice for any plumbing installation, flushing of the system prior to the use of Speedfit is recommended to remove any contaminants/chemical residue from elsewhere in the system.
- **Vermin:** Speedfit products will need special protection in vermin infested areas.
- **Tube insertion depths:**

	1/2" CTS	3/4" CTS	1" CTS
Twist and Lock Fittings	1 1/4"	1 5/8"	1 5/8"
Test Caps	1 1/8"	1 1/2"	1 1/2"
Brass Fittings	1 1/8"	1 1/2"	1 1/2"

- **Side Loads:** Fittings should not be subject to excessive side loads and they should not be used as support brackets. Tubing should be adequately supported to prevent excessive side loading.
- **Maximum torque values of threads:** in Ft Ilbs

		1/2" NPT	3/4" NPT	1" NPT
Plastic	NPT	2	3	3
Metal	NPT	3	4	4

It is recommended that all installations are checked prior to use to determine that a seal has been made.

John Guest USA, Inc. is not responsible for misprints or typographical errors.

TERMS AND CONDITIONS

The products described in this document are hereby offered for sale to be established by John Guest (USA) Inc., its subsidiaries and its authorized distributors. This offer and its acceptance by any customer (the "Buyer") shall be governed by all of the following Terms and Conditions. Buyer's order for any item described in this document, when communicated to John Guest (USA) Inc., its subsidiaries or an authorized distributor (the "Seller") verbally or in writing, shall constitute acceptance of this offer.

1. Terms and Conditions of Sale. All descriptions, quotations, proposals, offers, acknowledgments, acceptances and sales of the Seller's products are subject to and shall be governed exclusively by the terms and conditions stated herein (the "Agreement"). The Buyer's acceptance of any offer to sell is limited to the terms and conditions in the Agreement. Any terms or conditions in addition to, or inconsistent with those stated in the Agreement, proposed by the Buyer in any acceptance of an offer by the Seller, are hereby objected to. No such additional, different or inconsistent terms and conditions shall become part of the agreement between the Buyer and the Seller unless expressly accepted in writing by the Seller. The Seller's acceptance of any offer to purchase by the Buyer is expressly conditioned upon the Buyer's assent to all the terms and conditions in this Agreement, irrespective of any terms in addition to, or inconsistent with those contained in the Buyer's offer. Acceptance of the Seller's products shall in all events constitute such assent.

2. Documents. Unless provided otherwise in the Agreement, all catalog descriptions, illustrations, drawings and literature or independently submitted estimates of performance, weights and measurements or other specifications provided by the Seller are mere approximations and the Seller reserves the right to alter or amend the same at any time. The Seller reserves the right to correct clerical or technical errors in the contract documents. The Buyer shall furnish with his order all necessary specifications and information. The Seller takes no responsibility for goods manufactured, priced or delivered not in accordance with the order or the specifications unless the Buyer's order and specifications are clear and correct.

3. Prices. Unless otherwise provided, all prices contained in our quotations and written acceptances are ex works and do not include the cost of packing. All orders are accepted on the condition that all such prices are subject to revision by the Seller at any time before the goods are dispatched to take account of any price change. In the event that the Buyer does not place the entire order quoted by the Seller for the Buyer, the Seller reserves the right to revise its prices. The Seller also reserves the right to revise its prices if the Buyer modifies the specification or quantity of the goods, or the delivery requirements after the order has been accepted by the Seller.

4. Advice. All advice given in connection with the Seller's goods is provided without charge to the Buyer. Any advice and assistance given by the Seller to the Buyer is given at the Buyer's risk and the Seller shall not be liable for any loss, damage or claim arising therefrom.

5. Payment. (a) Unless otherwise provided in the Agreement, or explicitly agreed upon in writing by the Seller, payment is due in full 30 days from date of shipment of the items purchased herein under. (b) In the case of an installment contract, deliveries or parts, payment for each installment delivery or part shall be made under sub-clause (a) as if the same constituted a separate agreement. (c) Amounts not timely paid shall bear interest at the rate of 2-1/2% above the Seller's bank's prime rate from time to time in force. (d) A bank fee shall apply to all payments received via wire transfer. (e) Payments made with a credit card shall incur a 2% bank fee. (f) In the event that the Buyer fails within one calendar month of the date for payment to effect any payment which may be due under the Agreement or any agreement with the Seller, or if the Buyer commits any breach of the Agreement, or if the Buyer becomes insolvent or commits any act of bankruptcy or contemplation of liquidation, the Seller will be entitled, without prejudice to the Seller's other rights, to terminate the Agreement or any unfulfilled part thereof, or at the Seller's option to make partial deliveries.

6. Modifications and Cancellations. This Agreement is not subject to oral modification or cancellation. A Buyer's request for modification or cancellation will not be incorporated into the Agreement unless the request is accepted by the Seller in a writing that amends the Agreement. Acceptance of any such requested modification or cancellation shall be at the Seller's discretion and shall be upon such terms and conditions as the Seller may require.

7. Handling Charge. Goods supplied in accordance with the Buyer's order may later be returned to the Seller at the Seller's discretion provided the return is

pre-authorized, in writing and the merchandise is unused, in original packages, unaltered, clean and no older than 60 days from the date of shipment by the Seller. The Buyer shall pay to the Seller a handling charge of 25% of the purchase price of the returned goods. A copy of the original invoice for the merchandise must accompany all returns.

8. Delivery. (a) Any delivery dates quoted are approximate only and the Seller shall have no liability for any delays in delivery. (b) Unless provided otherwise, delivery of the goods shall be made when the Seller has notified the Buyer that the goods are ready for dispatch. Regardless of the method of delivery, delivery shall be made F.O.B. Seller's plant, where the risk of loss shall thereupon pass to the Buyer upon the Seller's delivery to a carrier. Notwithstanding that the Seller's prices are ex-works, the Seller is prepared by special contract to procure carriage or freight and insurance on behalf of the Buyer and at Buyer's cost in which event the Seller shall be under no liability for damage in transit or loss or damage to the goods beyond the point at which the Seller contracts to deliver the same. (c) Seller will not make drop shipments.

9. Inspection and Rejection. (a) The following provisions shall apply in relation to all deliveries of goods: the Seller shall not be held liable for any claims of damage in transit, shortage of delivery or loss of goods, unless in the case of shortage of delivery, a separate notice in writing is given to the carrier concerned and to the Seller within three (3) days of the receipt of the goods, followed by a complete claim in writing within five (5) days of receipt of the goods and in the case of loss of goods, a separate notice in writing is given to the carrier concerned and to the Seller and a complete claim in writing made within thirty (30) days of the date of consignment. The Buyer must inspect the goods on arrival from the carrier, however, where goods are accepted from the carrier concerned without being inspected, the delivery book of the carrier concerned must be signed "not examined". The Seller shall have the right to inspect the goods at the Buyer's premises in respect to any such claims made by the Buyer and the Buyer shall retain such goods until the Seller has inspected such goods or until the Seller has notified the Buyer that the Seller does not wish to inspect such goods. Any breach of these conditions in this provision shall serve as a waiver to any claim brought by the buyer. (b) Without prejudice to the Seller's other rights, should the Buyer fail for any reason to send the Seller forwarding instructions within ninety (90) days after the date of the Seller's notification that the goods are ready for dispatch or to accept delivery of the goods, the Seller shall be entitled at the Buyer's risk and expense to store the goods and/or to procure or effect storage of the goods elsewhere. Goods so stored shall be paid for as if they had been dispatched and/or accepted.

10. Special Tooling. Where it is necessary for the Seller to manufacture or to purchase special tooling, including without limitation tools, dies, jigs, mandrills, fixtures, molds, and patterns in order to execute a contract, the Buyer will be charged with a proportion of the cost of such special tools. Such special tooling shall be and remain the Seller's property notwithstanding payment of any charges made by the Buyer. In no event will the Buyer acquire any interest in apparatus belonging to the Seller which is utilized in the manufacture of the items sold hereunder, even if such apparatus has been specially converted or adopted for such manufacture and notwithstanding any charges paid by the Buyer therefore. Unless otherwise agreed, the Seller shall have the right to alter, discard or otherwise dispose of any special tooling or other property in its sole discretion at any time.

11. Test and Performance. (a) The Seller's goods are, where practicable, submitted to the Seller's standard test before delivery. If special tests are required, these shall be made at the Seller's premises unless otherwise agreed, and will be subject to an extra charge. (b) The Seller accepts no liability for failure to attain any performance figures quoted by the Seller unless the Seller specifically has guaranteed them with an agreed sum as liquidation damages and the Buyer has suffered actual loss by reason of the failure to attain the figures quoted. (c) Any particulars of weights and measurements, power and consumption, power output or performance relating to the goods and like matters furnished by the Seller to the Buyer in the Seller's catalogs, literature or otherwise, are approximate and are intended only to present a general idea of the goods to be supplied and unless previously agreed specifically in writing shall not form part of the Agreement.

12. Buyer's Property. Any designs, tools, patterns, materials, drawings, confidential information or equipment furnished to the Seller by the Buyer, or any other items which become the Buyer's property, may be considered obsolete and may be destroyed by the Seller after two (2) consecutive years have elapsed without the Buyer placing an order for the items which are manufactured using such property. The Seller shall not be responsible for any loss or damage to such property while it is in the Seller's possession or control.

13. Taxes. Unless otherwise indicated, all prices and charges are exclusive of excise, sales, use, property, occupational or like taxes which may be imposed by any taxing authority upon the manufacture, sale or delivery of the items sold hereunder. If any such taxes must be paid by the Seller, or if the Seller is liable for the collection of such tax, the amount thereof shall be in addition to the amounts for the item sold. The Buyer agrees to pay all such taxes or to reimburse the Seller therefore upon receipt of its invoice. If the Buyer claims exemption from any sales, use or other tax imposed by any taxing authority, the Buyer shall promptly indemnify and hold the Seller harmless from and against any such tax, as well as any interest or penalties thereon which may be assessed if the items are held to be taxable.

14. Warranty. (a) The Seller warrants that the items sold hereunder shall be free from defects in material or workmanship at the time of shipment by the Seller. The Seller warrants that if within 12 months of delivery of the goods to the Buyer the Buyer returns immediately to the Seller's premises any of the said goods which the Buyer believes to be defective, carrier paid, properly packed and clearly marked with the Buyer's full name and address and any other information such as serial numbers which may be necessary to enable the goods to be identified, together with a complete description of the respects in which it is alleged that the goods are defective, they will be repaired or new goods will be supplied in exchange and the goods so repaired or such new goods will be delivered to the Buyer free of charge at the Seller's premises provided that the foregoing warranty shall only be applicable if upon demand by the Seller, the Buyer proves to the Seller's satisfaction: (i) that the defect was due solely to defective workmanship; (ii) that no alterations or repairs have been made to the goods except with the Seller's written consent; (iii) that the defect was not caused by any act of the Buyer or its agents; and (iv) that the defect was not caused by any matter beyond the reasonable control of the Seller, including, without limitation, accident or normal wear and tear. (b) For John Guest PEI, MWI and PSEI Series Plumbing products and Speedfit PEX Pipe only, the warranty period contained in sub-paragraph (a) may be extended to 300 months (25 years) from date of delivery of the goods to the Buyer provided that, in addition to all other requirements, Seller's products are: (i) used in domestic plumbing applications; (ii) installed by a Licensed Contractor, Plumber or qualified equipment installation professional; and (iii) installed and operated in accordance with published John Guest technical specifications. (c) All costs and expenses, including freight charges, customs duties, and insurance incurred in returning the goods to the Seller's premises in accordance with this provision shall be paid by the Buyer. The benefit of this warranty shall not be assignable by the Buyer. (d) The warranty contained in sub-paragraphs (a) and (b) above does not extend to any goods not manufactured by the Seller even though supplied by the Seller nor does it extend to any second-hand or reconditioned goods nor does it extend to components manufactured by the Seller but installed, attached or welded by the Buyer or his customer on equipment not manufactured by the Seller. Goods not manufactured by the Seller carry only the warranty (if any) of their makers and the Buyer is entitled to the benefit thereof only so far as the Seller has the power to transfer it. (e) This warranty comprises the sole and entire warranty pertaining to items provided hereunder; the Seller makes no other warranty, guarantee, or representation of any kind whatsoever. All other warranties, including but not limited to, merchantability and fitness for purpose, whether expressed or implied, or arising by operation of law, trade usage, or course of dealing are hereby disclaimed. (f) Notwithstanding the foregoing, there are no warranties whatsoever on items built or acquired wholly or partially to the Buyer's designs or specifications.

15. Limited Remedy. The Seller's liability arising from or in any way connected with the items sold or this Agreement shall be limited exclusively to repair or replacement of the items sold. In no event shall the Seller be liable to the Buyer or any 3rd party for any incidental, consequential or special damages of any kind or nature whatsoever, including but not limited to lost profits arising from or in any way connected with this agreement or items sold hereunder, whether alleged to arise from breach of contract, express or implied warranty, or in tort, including without limitation, negligence, failure to warn or strict liability.

16. Indemnity for Infringement of Intellectual Property Rights. (a) The Buyer shall defend and indemnify the Seller against all actions, claims, demands, penalties and costs by 3rd parties in tort, or for infringement, or alleged infringement, of patents, trademarks, copyrights, trade dress, trade secret or other rights of any 3rd party resulting from the goods manufactured in accordance with the Buyer's specifications or based on any information provided by the Buyer. The Buyer will defend any action against the Seller for title, patent, trademark, copyright infringement, or other claimed by a 3rd party at the Buyer's sole cost and expense. (b) The Seller shall have no liability for infringement of any patents, trademarks,

copyrights, trade dress, trade secrets or similar rights except as provided in this provision. The Seller will defend and indemnify the Buyer against allegations of infringement of US patents, US trademarks, copyrights, trade dress and trade secrets ("Intellectual Property Rights"). The Seller will defend at its expense and will pay the cost of any settlement or damages awarded in an action brought against the Buyer based on an allegation that an item sold pursuant to this contract infringes the Intellectual Property Rights of a 3rd party. The Seller's obligation to defend and indemnify the Buyer is contingent on the Buyer notifying the Seller within 10 days after sole control over the defense of any allegations or actions, including all negotiations for settlement or compromise. If an item sold hereunder is subject to a claim that it infringes the Intellectual Property Rights of a 3rd party, the Seller may, at its sole expense and option, procure for the Buyer the right to continue using said item, replace or modify said item so as to make it non-infringing, or offer to accept return of said item and return the purchase price less a reasonable allowance for depreciation. Notwithstanding the foregoing, the Seller shall have no liability for claims of infringement based on information provided by Buyer, or directed to items delivered hereunder for which the designs are specified in combination or use in a system of any item sold hereunder. The foregoing in this provision shall constitute the Seller's sole and exclusive liability and the Buyer's sole and exclusive remedy for infringement of Intellectual Property Rights.

17. Lien. In addition to any right of lien to which the Seller may by law be entitled, the Seller shall have a general lien on all goods of the Buyer in the Seller's possession (although such goods or some of them may have been paid for) for the unpaid price of any other goods sold and delivered to the Buyer by the Seller under the same or other contracts.

18. Waiver. The Seller's rights shall not be affected or restricted by any indulgence or forbearance granted to the Buyer. No waiver by the Seller of any breach shall operate as a waiver of any later breach.

19. Force Majeure. The Seller shall be excused from performing any of its obligations under this Agreement which are prevented or delayed by any occurrence not within the reasonable control of the Seller, including but not limited to, accidents, acts of God, destruction or damage to the goods or the Seller's manufacturing plant, delays or failures in delivery of carriers or suppliers, shortages of materials, strikes or other labor matters, floods, earthquakes, fire, riots, explosions, or any regulations, rules, ordinances or orders of any governmental authority, federal, state or local, whether such cause exists at the date of the order or not.

20. Buyer's Representation of Solvency. The Buyer hereby represents that as of the signing of this Agreement it was not insolvent within the meaning of the Uniform Commercial Code or the Bankruptcy Laws of the United States.

21. Assignment and Delegation. The rights and obligations of the parties under this Agreement may not be assigned or delegated, except on the express written consent of the other party to the assignment or delegation.

22. Integration. The rights and obligations of the parties and the terms and conditions set forth herein, together with any amendments, modifications and any different terms and conditions expressly accepted by the Seller in writing, shall constitute a complete and exclusive statement of the terms of this Agreement. This Agreement supersedes not only all prior agreements, but also oral agreements made contemporaneously with the execution of this Agreement. All such materials may not be used to supplement, explain, or contradict the terms of this Agreement.

23. Severability. If any of these conditions or any part thereof purports to exclude or restrict or limit any liability and such exclusion or restriction or limitation is prohibited or rendered void or unenforceable by any legislation to which it is subject, or is itself prohibited or rendered void or unenforceable by any legislation to which it is subject, then the exclusion restriction or limitation on the condition or part thereof in question shall be so prohibited or rendered void or unenforceable and the validity or enforceability of any other part of these provisions shall not thereby be affected.

24. Governing Law/Limitation on Actions. The terms, conditions, rights, and obligations under this Agreement shall be construed under the laws of the State of New York, without regard to principles of conflicts of laws. No actions arising out of the sale of the items sold hereunder or this Agreement may be brought by the Buyer more than two (2) years after such cause of action accrues.

John Guest Companies



John Guest USA, a world-leading supplier of Fluid System Products, located in Northern New Jersey, is part of a progressive and professional organization with multiple locations worldwide. For over 30 years the John Guest organization has built its reputation by providing high quality products and high levels of customer service.

Through a strong commitment to growth and innovation, John Guest USA will continue to serve its community and customers well into the future.

John Guest USA, Inc. distributes its products across North, Central, and South America, the Caribbean, and the US Virgin Islands.



John Guest USA Inc.

180 Passaic Avenue

Fairfield, NJ 07004

Web: www.johnguest.com

Email: info@johnguest.com

Email Orders: jgusa.orders@johnguest.com

Toll Free: 800.945.4872

Tel.: 973.808.5600

Fax: 973.808.5036



John Guest Ltd.

Horton Road, West Drayton, Middlesex, UB7 8JL, England.
Tel: (44) (1) (895) 449233 Fax: (44) (1) (895) 420321



John Guest France S.A.

143-147 Avenue Charles Floquet, Parc Gustave Eiffel,
93593 Le Blanc Mesnil, Cedex, FRANCE.
Tel: (33) (1) 48 65 52 29 Fax: (33) (1) 48 65 43 40



John Guest GmbH

Ludwig-Erhard-Allee 30, D-33719 Bielefeld, GERMANY
Tel: (49) (521) 972 560 Fax: (49) (521) 972 5680



John Guest Czech s.r.o.

Vrbenska 2290, CZ - 37001 Ceske Budejovice, CZECH REPUBLIC.
Tel: (420) (387) 002 040 Fax: (420) (387) 002 048



John Guest Polska Sp. z o.o.

Ul. Starolecka 7, 61-361, Poznan, POLAND.
Tel: (48) (61) 87 80 408 Fax: (48) (61) 87 80 285



John Guest s.r.l.

Via Vincenzo Lancia 13, 10038 Casabianca-Verolengo (Torino), ITALY.
Tel: (39) (011) 957 5880 Fax: (39) (011) 957 6144



John Guest s.l.

C/ de La Electronica No.7, Poligono Industrial La Ferreria,
Montcada i Reixac, 08110 Barcelona, SPAIN.
Tel: (34) (93) 575 0027 Fax: (34) (93) 575 0178



John Guest Korea Ltd

Unit 552-27 Kajwa Dong, Seo Ku,
Incheon City, 404-812 Korea.
Tel: (82) (32) 584 3370 Fax: (82) (32) 584 3372



John Guest Pacific Ltd

P.O. Box 19553, 606 Rosebank Road, Avondale,
Auckland, NEW ZEALAND.
Tel: (64) (9) 8281353 Fax: (64) (9) 828 5927



John Guest Pacific Ltd

Unit 6, 33 Nyrang Street, Lidcombe, Sydney
N.S.W. 2141, AUSTRALIA.
Tel: (61) (2) 9737 9088 Fax: (61) (2) 9737 9122