



BARRON™

1.0 GPF Pressure Assist Toilet Round Bowl with 12" Rough-in



BARRON™

1.0 GPF PRESSURE ASSIST TOILET

Round Bowl with 12" Rough-in

FEATURES & SPECIFICATIONS

- Powerful pressure assist flush technology
- Upgraded brass bolt set
- Chrome left and right handle options
- MaP Score 1000g
- Extra large water spot for a clean bowl
- Fully glazed trapway for easy waste removal

CERTIFICATIONS



Materials: Vitreous China **Finish Color:** White

Codes/Standards:

ASME A112.19.2/CSA B45.1

DOE - Energy Policy Act 1992

California Energy Commission (CEC)

CALGreen Compliant

MEASUREMENTS

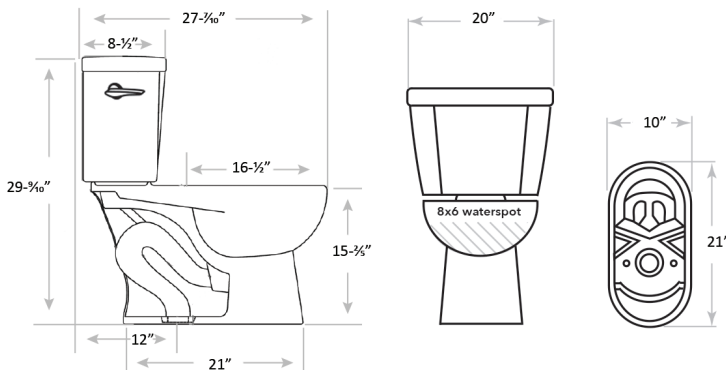

BULK PACKAGING

C44.000.01 Left Combo
C44.001.01 Right Combo

44.0200.01 Round Bowl

UPC Code 732291442008

Packaging Type Kraft Corrugated

Packaging Dimensions 15" W
17.2" H
26.9" D

Packaging Weight 47.42

Skid Quantity 12 or 18

44.0302.01LWH Tank (Left)
44.0302.01RWH Tank (Right)

UPC Code Left 732291443203

UPC Code Right 732291433210

Packaging Type Kraft Corrugated

Packaging Dimensions 10.8" W
16.3" H
21.7" D

Packaging Weight 44.71

Skid Quantity 30

**LIMITED LIFETIME WARRANTY on vitreous china products. Toilet tank trim: fill valve and flush valve assembly and plumbing fittings are warranted for a period of fifteen (15) years to the purchaser from the date of purchase. Call Niagara for complete warranty details.