



Installation Instructions



Germicidal UV Light For ice cube machines

Not compatible with flaker/chipper machines

Ice UV fights mold growth and bacteria in ice making machines. It extends the life of the ice machine by reducing microbial growth, lowers maintenance costs by extending the time between cleanings and results in cleaner, healthier ice.

For lamp replacements contact

1-800-741-1195

For technical support contact

dale@freshaireuv.com

Part # TUV-ICE-DT
(entire unit)

Part # TUVL-ICE
(replacement lamp)

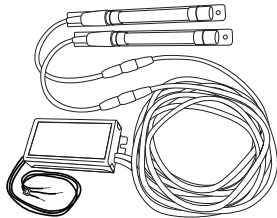

Parts Included

- A Ice UV Lamp
- B Lamp Shield
- C Power Supply
- D UV Warning Sticker
- E Zip Tie
- F Lamp Shield Bands
- G Connectors
- H Locking Nuts
- I Bolts
- J Self-tapping screws
- K Plastic Rivets
- L Zip

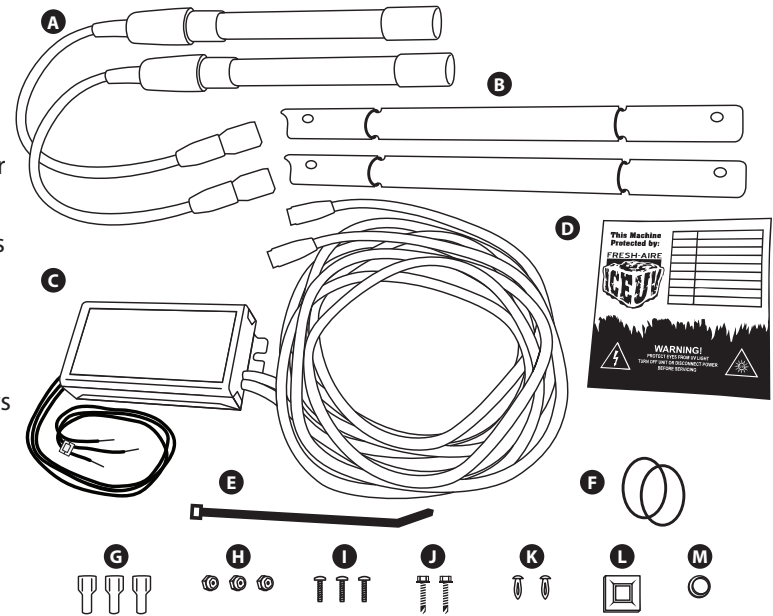

IMPORTANT!

- Only qualified technicians should install this product
- Install in accordance with relevant building codes
- Read instructions carefully including safety warnings



WARNING
PROTECT EYES FROM UV LIGHT
TURN OFF UNIT OR DISCONNECT
BEFORE SERVICING



1 Prepare ICE UV Lamp Mounting Location

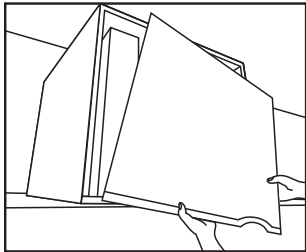

1. Remove ice maker cover

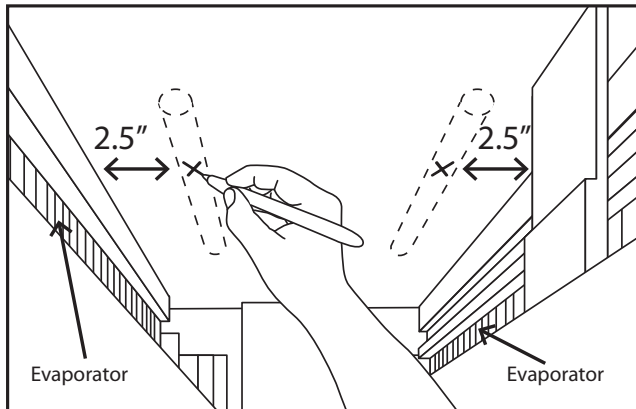

2. Mark a spot 2.5" in front of the center of each evaporator on the underside of the lid of the machine

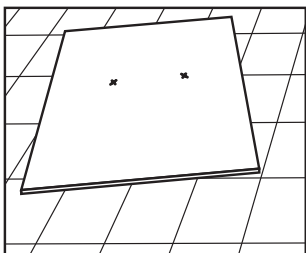

3. Remove ice maker lid and place on the floor or a flat surface to attach lamps

2 Mount ICE UV Lamps to Lid of Ice Maker

With the mounting location marked on the lid the UV lamps can be mounted. First remove the metal shield then mount the shield using self-tapping screws. Replace lid onto ice maker.

1. Remove shields from lamps

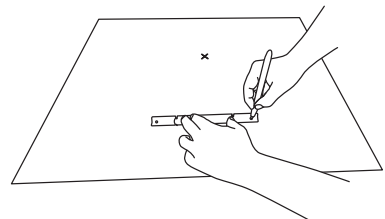
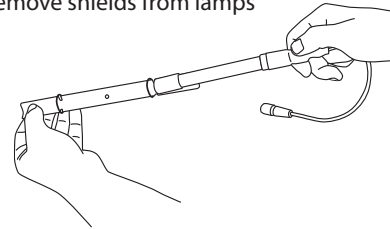

2. Use shield to mark screw holes

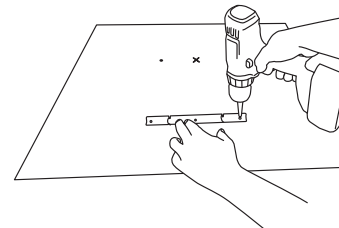

3. Mount shields with self-tapping screws

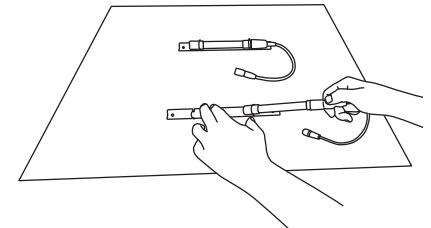

4. Replace lamps onto shields

3 Power Supply Installation

1. Mount the power supply near the control box inside the ice maker. Avoid drilling holes by passing the lamp cables over the interior partition.
2. Use the wiring diagram below to connect to 120-277 VAC power. Use zip-ties to dress cables.

IMPORTANT!
Mount power supply & wires away from control board & sensors to prevent interference

IMPORTANT!
Connect to constant power. Do not cycle UV light on and off. Cycling will reduce the life of the UV lamp and limit effectiveness.

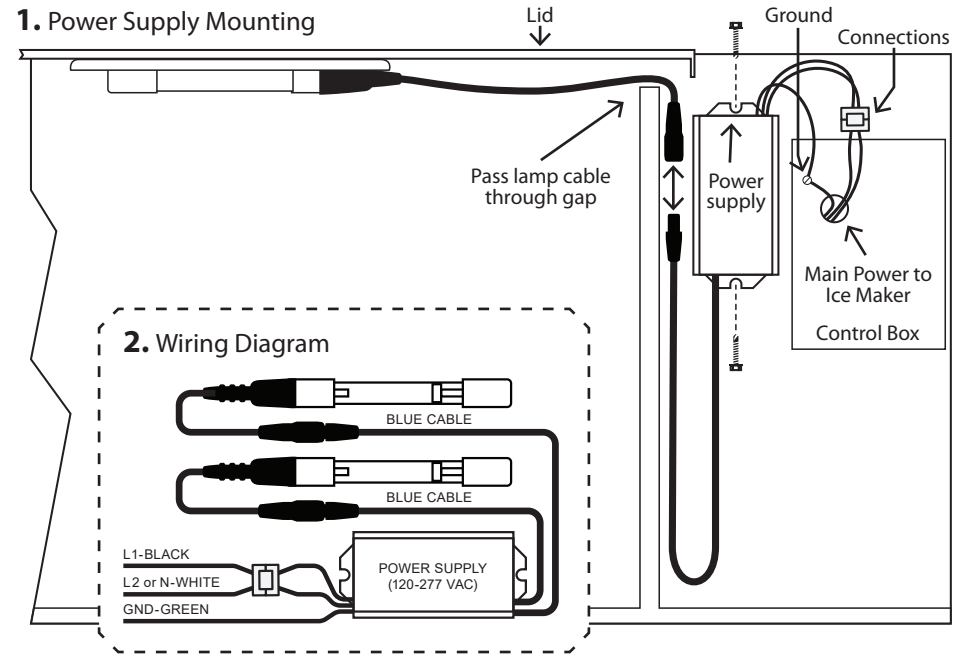

4 Connect UV Lamps

1. When all the other components are properly installed connect the UV Lamp cables to the Power supply cables.
2. Make sure the flanges are aligned and then push the connectors firmly together. A tight connection ensures a proper water-resistant seal.

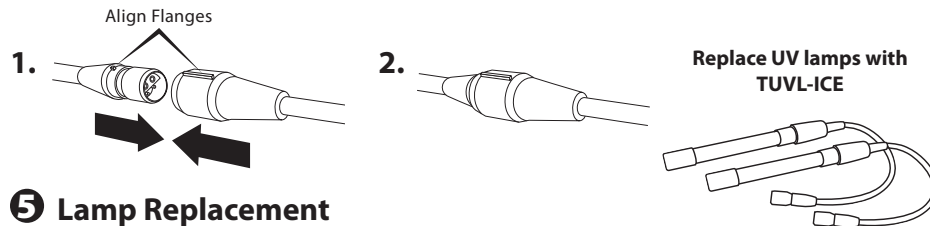

5 Lamp Replacement

The germicidal UV lamps in ICE UV® need to be replaced every 2 years. Note: UV lamps will continue to emit visible light but lose germicidal effectiveness over time.

Lamps are warranted for 2 years, power supply for lifetime.

Contact Fresh-Aire UV for UV Lamp replacement #TUVL-ICE

Caution: UV lamps contain small amounts of mercury - dispose of lamps in accordance with local environmental regulations. For more information visit www.lamprecycle.org

Manufacturer's Warranty:

This warranty supersedes and replaces any warranty statements orally made by the Sales Person, Distributor or Dealer or contained in the written instructions or other Brochures or informational documents in relation to this product. This warranty gives you specific legal rights, and you may also have other rights which vary from State to State.

What Does This Warranty Cover? This lifetime limited manufacturer warranty covers any defects or malfunctions in material and workmanship under normal use and service when operated and maintained in strict accordance with manufacturer's instructions. THIS WARRANTY DOES NOT COVER PRODUCTS PURCHASED FROM UNAUTHORIZED VENDORS OR PRODUCT INSTALLED BY UNLICENSED CONTRACTORS. This warranty does not cover parts damaged as a result of misuse, abuse, or any use other than its intended use, accident, acts of god, neglect, or from improper operation, maintenance, installation, modification or adjustments. Triatomic Environmental, Inc. shall have no responsibility for charges incurred by the customer for installation, removal or shipping of warranted items to manufacturer. This warranty does not cover parts or equipment used with the Fresh-Aire Ice UV system that are not manufactured by Triatomic Environmental, Inc. This warranty shall be void if UV lamps from manufacturer's other than Triatomic Environmental, Inc. are used with this equipment. Mercurial and incidental damages are not recoverable under this warranty. Manufacturer assumes no liability for any harm, which may occur as a result of the use of the equipment herein and shall not be liable for consequential or any other damages whether or not caused by manufacturer's negligence or resulting from any express or implied warranty or breach thereof. Consequential damages for the purpose of this warranty shall include, but not be limited to, loss of use, income or profit, or loss of or damages to property or injury or death to persons or animals occasioned by or arising out of operation, use, the operation, installation, repair or replacement of the equipment or otherwise.

UV light & plastics: When installed, maintained and operated in accordance with the ICE-UV installation manual, Triatomic warrants the use of the ICE-UV systems to be free from excessive degradation of internal plastic components caused specifically and directly by UV-C light exposure. This material warranty does not cover any plastic material degradation caused by any means other than UV-C light exposure. It is to be understood that in many cases, plastic material discoloration can occur from the use of this product and is not considered to be an excessive source of material degradation and is considered to be a normal by-product caused from the use of this product. Triatomic is not responsible for replacement of discolored components.

How Long Does The Coverage Last? 1) Power Supply: For as long as you own the specific ice machine where the ICE-UV system is originally installed. 2) TUVL-ICE Series Ultraviolet Lamp is warranted for germicidal output for two (2) years from the date of installation. This warranty is not transferable.

How Do You Get Service? In order to be eligible for service under this warranty you MUST return the warranty registration card or register online at www.freshaireuv.com. If something is wrong with your product, call your installing contractor to receive a Return Merchandise Authorization (RMA) and instructions for returning the product to a licensed distributor in your area or the manufacturer. Once the product is returned, we will inspect your product and contact you within 10 business days of our receipt of the product to give the results of our inspection. If we determine that the product is covered under this warranty, we will ship to you at no additional cost a replacement part. Replacement parts may be refurbished. If we determine that the product is not covered under this warranty, or that this warranty is void, the product will be returned to you COD. There is no charge for inspection.

What Will Triatomic Environmental, Inc. Do? Triatomic Environmental, Inc. will replace any defective or malfunctioning part at no charge. Triatomic is not responsible for any labor charges and shipping charges of defective product to our warranty department.