



24" straight grab bar  
**8001024**

### Features

- Adjustable mounting brackets to fit specific installation requirements.
- Elliptical shape makes the bar easier to grip.
- Available in finishes to coordinate with nickel and silver shower door finishes.

### Material

- Anodized aluminum construction with a durable rust-proof and chip-resistant finish.

### Installation

- Installs from front side of wall.

### Recommended Products/Accessories

K-23723 Faucet cleaner

### Included Components

Additional Components:  
Installation hardware



### Codes/Standards

ASTM F446

### STERLING® Warranty - Grab Bars

See website for detailed warranty information.

### Available Colors/Finishes

*Color tiles intended for reference only.*

Color	Code	Description
	N	Nickel
	V	Matte Silver

---

1-800-STERLING (1-800-783-7546)

Kohler Co. reserves the right to make revisions without notice to product specifications.

For the most current Specification Sheet, go to [www.sterlingplumbing.com](http://www.sterlingplumbing.com).

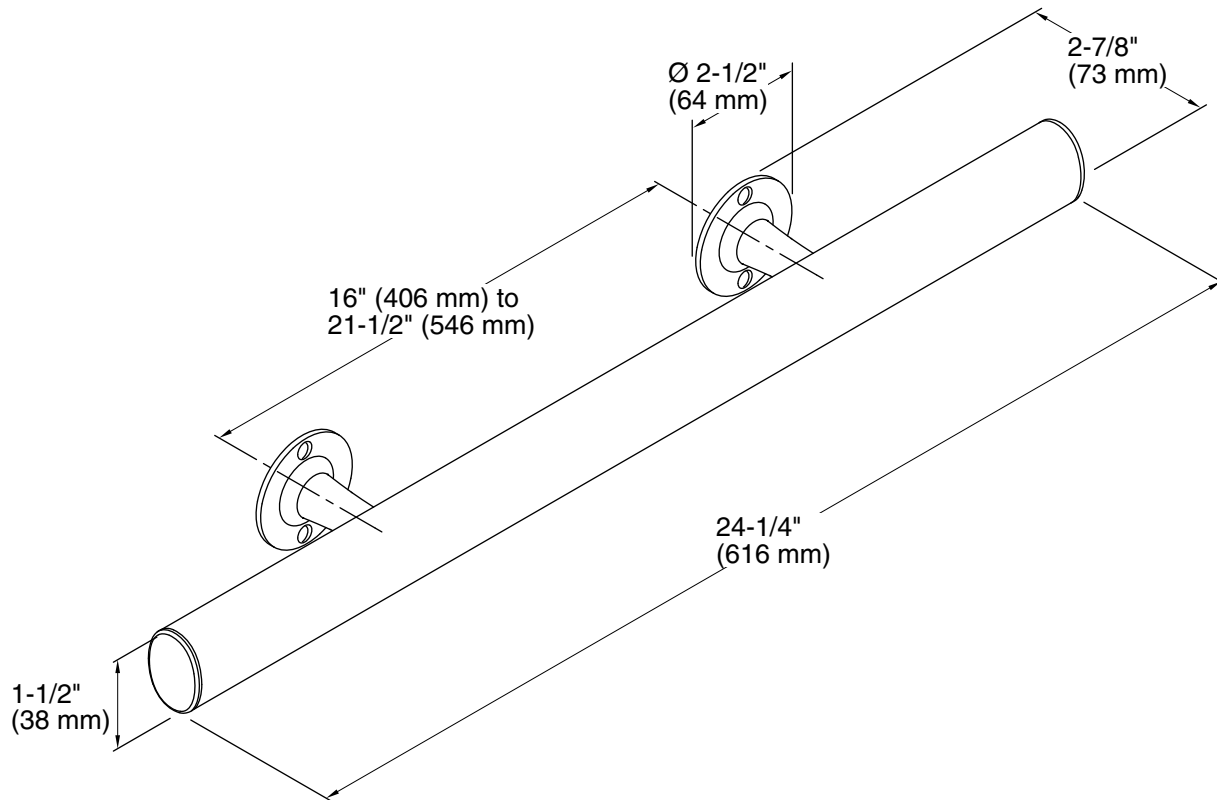

### Technical Information

All product dimensions are nominal.

Material: Anodized Aluminum

### Notes

Install this product according to the installation guide.

**WARNING:** Risk of personal injury. Unless properly installed, the grab bar may not adequately support the weight of the user.

Custom Walls – Fasten grab bar directly to studs when possible. If not possible, install a 1" x 6" blocking board to studs prior to installing wallboard and finished wall material.

Sterling Age-in-Place Surrounds – Obtain backer board locations from the specification sheet for your model to select the appropriate grab bar size.