

AUTOMATIC TRAP PRIMER VALVE

▶▶ 695 SERIES

PrimePerfect™

SPECIFICATION

Sioux Chief 695 Series PrimePerfect™ trap primer valves shall be used where replenishment of water in floor drain traps is required. Trap primer valve shall be ½" FIP inlet × ½" MIP outlet. Automatic trap primer valve shall activate with a 10 PSIG pressure drop between 30–150 PSIG. Water release shall be factory set. Trap primer valve shall have large port openings. Trap primer valve shall be UPC/IAPMO listed, and ASSE certified to the ASSE 1018 standard.

INSTALLATION

Replenishes water in floor drain traps to prevent escape of sewer gas. The number of traps serviced by any trap primer is a function of activation frequency and evaporation rate and should be determined by the design engineer and/or the installing contractor. Install to a ½"–1½" nominal water line, near the trap(s) to be served. Install in the upright, vertical position only. Install at least 5" above the grid of the floor drain or the flood rim of the fixture which the trap serves. Install near plumbing fixtures to insure a full pressure drop of 10 PSI or more. If the trap primer is installed too far upstream in the system, the pressure drop may not be enough for activation. Install a vertical loop that rises above the supply line tee. (see figure 1) Flush branch line prior to installing the trap primer. Install MIP adapter. Connect trap primer. Install FIP union to bottom. Use PTFE tape on both connections. Do not use pipe dope. Do not solder or braze directly to trap primer or fittings installed in trap primer. Water discharge is factory set—no adjustment is required on normal installations. For static pressures over 100 PSI, adjustments may be necessary. First loosen the nipple locknut (10, below), then turn the nipple (19, below) counter-clockwise until the trap primer starts dripping, turn the nipple clockwise ¼-turn to stop dripping, and re-tighten nipple locknut.

WORKING PRESSURE

30–250 PSIG

OPERATING PRESSURE

Activates with a 10 PSIG pressure drop at 30–150 PSIG

COMPONENTS

- | | |
|---------------------------|-------------------------------|
| 1: Cap | 11: Vacuum breaker |
| 2: Stainless steel screws | 12: Sediment screen |
| 3: Diaphragm | 13: Diaphragm stop washer |
| 4: Valve stem spring | 14: Diaphragm spring retainer |
| 5: Valve stem nut | 15: Valve stem |
| 6: rubber valve disc | 16: Diaphragm spring |
| 7: Valve stem guide | 17: Valve washer |
| 8: Body | 18: Diaphragm adjustment nut |
| 9: Nipple seat washer | 19: Brass nipple |
| 10: Nipple locknut | |

ITEM # SUBMITTED	_____
JOB NAME	_____
LOCATION	_____
ENGINEER	_____
CONTRACTOR	_____
PO#	_____ TAG _____



695-01

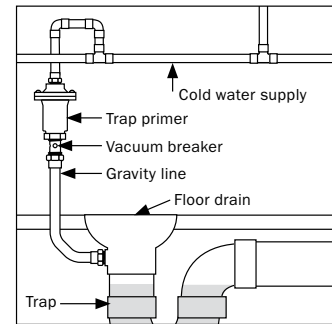
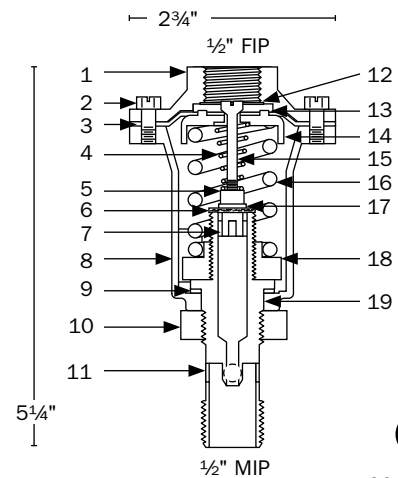

Fig. 1



Item Number

695-01