

Gasketed Sewer Pipe and Fittings Installation Guide

Suitable for Gasketed Sewer Applications

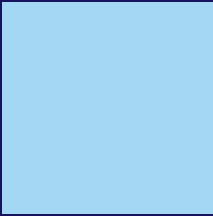

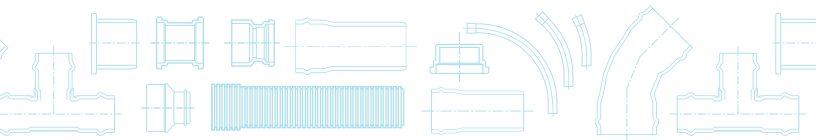

ROYAL Pipe & Fittings Solutions

Royal Municipal Solutions Gasketed Sewer Pipe and Fittings Installation Guide

TABLE OF CONTENTS

Introduction	2
Receiving	3
Unloading	4
Storage	5
Handling	6
Pipe Installation Instructions	7
• Alignment and Grade	
• Trench Width and Support	
• Trench Boxes	
• Preparation of Trench Bottom	
• Embedment Materials	
• Selection of Embedment Materials	
• Laying of Pipe and Pipe Embedment	
• Final Backfill	
• Assembly of Gasket Joints	
• Field-Cut Pipe to Pipe	
Fittings Installation Instructions	15
• Sewer Laterals	
• Change Of Direction	
• Manhole Connections	
• Service Connections	
Testing Sewer Lines	20
Pipe and Joint Deflection	23
• Inspection and Testing	
Installing Pipe Through Casings	25
Dimensions	28-29
Conversion Chart	29

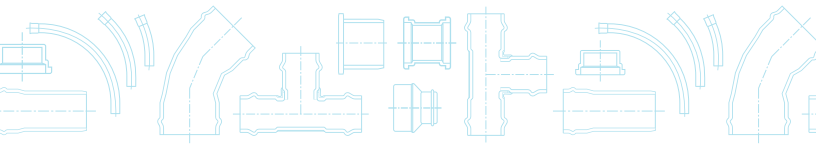

Introduction

This guide is intended for use by installers, supervisors, and inspectors responsible for the installation of Royal Municipal Solutions Gasketed Sewer Pipe, STI Fittings and Kor Flo™ Profile Pipe and Fittings. It provides guidelines for correct receiving, handling and installation of PVC Pipe and Fittings. If used correctly, the information in this booklet can help maximize product performance and minimize the possibility of field problems.

This booklet is not intended to assume the authority of the Design Engineer. System requirements and actual field conditions will vary significantly. The sole responsibility for all design and installation decisions lies with the Design Engineer.

All Local Health and Safety Regulations must be followed.

This booklet is also available electronically on the Royal Building Products website www.royalbuildingproducts.com.



Certified to
B182.2/B182.4



D3034
F679



OPS 1841
OPSPD 806.040



NQ 3624-130
NQ 3624-135

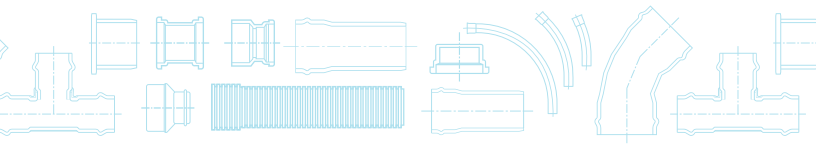

Receiving

When receiving a pipe and fittings shipment at the job site, the contractor or purchaser should exercise established precautions. Each shipment should be inventoried and inspected upon arrival. The pipe and fittings are inspected and loaded with due care at the factory using methods acceptable to the carrier. It is the carrier's responsibility to deliver the shipment in good condition, and it is the receiver's responsibility to ensure that there has been no loss or damage.

The following procedures are recommended for acceptance of delivery:

1. Conduct overall examination of the load. If the load is intact, ordinary inspection while unloading should be sufficient to ensure that the pipe has arrived in good condition.
2. If the load has shifted, has broken bundles, or shows rough treatment, carefully inspect each piece for damage.
3. Check total quantities and details of each item against shipping documents.
4. Note any damaged or missing items on the delivery receipt.
5. Notify the carrier immediately and make a claim according to their instructions.
6. Do not dispose of any damaged material. The carrier will inform you of the procedure to follow.
7. Replacements for shortages and damaged materials are not re-shipped without request. If replacement materials are needed, please re-order from your Royal distributor or representative.

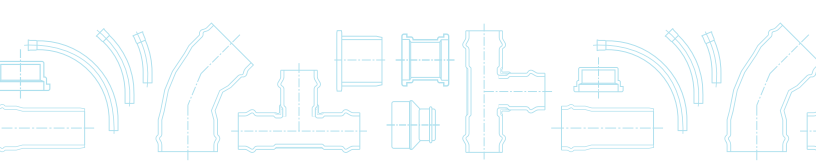

Unloading

The following recommendations should be followed when unloading pipe and fittings:

1. Remove restraints from the bundles. These may be straps, ropes, or chains with padding.
2. Remove any boards on the top or sides of the load that are not part of the packaging.
3. Use caution when unloading fittings with any type of machinery. Do not drop or throw fittings. Royal is not responsible for damage to mishandled fittings.
4. Using a forklift (or a front-end loader equipped with forks), remove the top bundles of pipe, one at a time from the truck.
5. If a forklift is not available, use a spreader bar with fabric straps capable of carrying the load. Space straps approximately 2.4m (8') apart. Loop straps under the load.
6. During the removal and handling, ensure that the bundles do not impact anything (especially in cold weather).
7. Place pipe bundles on level ground.
8. Do not stack bundles more than 2.4m (8') high.
9. Do not handle bundles with individual chains or single cables, even if padded.
10. Do not attach lifting cables to dunnage or bands.
11. Protect bundles with packing materials the same way they were protected while on the truck.
12. Do not unload pipe bundles by hand.
13. If unloading equipment is not available, pipe may be unloaded by removing individual pieces. Care should be taken to ensure that pipe is not dropped or damaged.

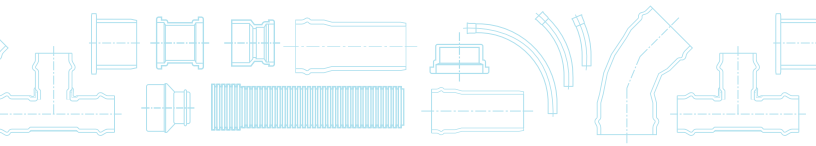

Storage

The following procedures are recommended to prevent damage to the pipe:

1. Store the pipe at the site in bundles.
2. Avoid compression, deformation or damage to bell ends of the pipe.
3. When bundles are stacked, ensure that the weight of the upper bundle does not cause deformation to pipe in the lower bundle (maximum 2 bundles high).
4. Support pipe bundles at 2.4m (8') intervals, 1.2m (4') from each end on wood blocking to prevent damage to the bottom surfaces during storage.
5. Store lubricant in tightly sealed containers under cover.
6. Do not store pipe and fittings where gaskets may be exposed to contamination (ie. grease, oil etc).
7. Protect the interior and sealing surfaces of pipe and fittings from dirt and foreign material.
8. When the bundles are stacked, ensure that the stack remains stable.
9. When pipe and fittings are being stored for a prolonged period, the bundles should be covered with an opaque cover, to protect against exposure to direct sunlight (ozone, UV radiation). The covering should allow adequate air circulation above and around the pipe to prevent excessive heat accumulation.

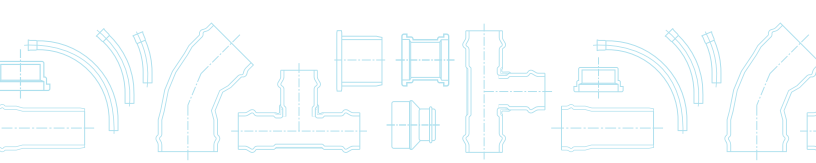

Handling

The following procedures are recommended for handling pipe and fittings:

1. When using mechanical equipment, exercise care to prevent damage to the pipe and fittings.
2. Lower pipe and fittings carefully from trucks and into trenches. Do not drop pipe and fittings. Dropped pipe and fittings can be damaged and should not be used.
3. In sub-zero (freezing) temperatures, use caution to prevent impact damage. Handling methods considered acceptable for warm weather are unacceptable during cold weather. As the temperature approaches and drops below freezing, the flexibility and impact resistance of PVC pipe is reduced. Extra care should be used in handling in cold weather. Pipe at the bottom of the stack may become out of round due to the weight of the material stacked on top. This normally corrects itself soon after the load is removed. Under freezing conditions, this may take longer than in warmer temperatures.
4. As with cold temperature, excessive heat can also affect the flexibility of PVC pipe. Although pipe affected by excessive heat will retain its long-term performance properties, it should be handled with extra care. Avoid exposing the pipe and fittings to welding torches, heaters and if possible excessive sunlight, which will cause the pipe to discolour. Physical properties such as pipe stiffness and tensile strength of PVC pipe are not affected by surface discolouration.
5. When placing the pipe along a trench (stringing), place pipe on the opposite side of the trench from the excavated earth. Place pipe with bell ends in the direction of the work progress.

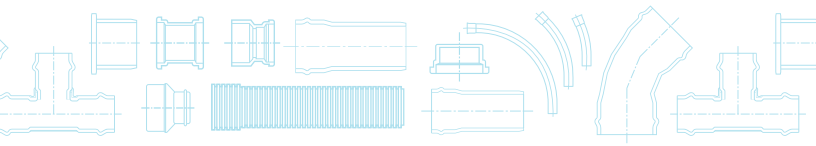

Pipe Installation Instructions

Alignment and Grade

All pipe should be laid to, and maintained at alignment and grade as established by the Design Engineer. The grade to which the pipe is to be laid is generally specified on the project drawings. Laterals, manholes and catch basins should be installed at the required locations with all structures plumb.

Trench Width and Support

Trench width at the ground surface will vary with and depend upon the depth, type of soils, and the position of surface structures. Minimum trench widths for Gasketed Sewer Pipe and Kor-Flo™ Pipe are shown in Tables 1 and 2 respectively. The trench width must be at least 450mm (18”) with a clearance of 150mm (6”) on each side of the pipe. If the trench widths must exceed the values shown in the tables below, or if the pipe is installed in a compacted embankment, pipe embedment should be compacted at least 2.5 pipe diameters from the pipe on both sides of the pipe or to the trench walls, whichever is less.

Table 1 - Minimum Trench Widths - Gasketed Sewer Pipe

Nominal Pipe Size	Minimum Trench Width	
	mm (in)	# of Pipe Diameters
100 (4)	457 (18)	4.3
125 (5)	457 (18)	2.9
150 (6)	457 (18)	2.9
200 (8)	610 (24)	2.4
250 (10)	610 (24)	2.1
300 (12)	762 (30)	2.4
375 (15)	762 (30)	2.0
450 (18)	762 (30)	1.8
525 (21)	915 (36)	1.6
600 (24)	915 (36)	1.5
675 (27)	1016 (40)	1.5

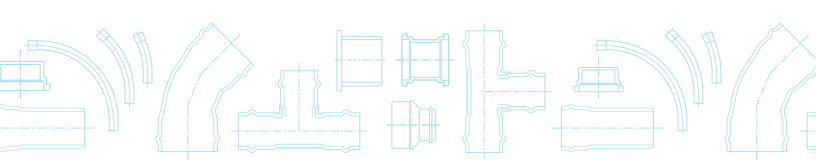

Pipe Installation Instructions Continued

Table 2 - Minimum Trench Widths - Kor-Flo™ Pipe

Nominal Pipe Size	Minimum Trench Width	
	mm (in)	# of Pipe Diameters
200 (8)	610 (24)	2.8
250 (10)	610 (24)	2.2
300 (12)	760 (30)	2.4
375 (15)	760 (30)	2.0
450 (18)	915 (36)	1.9
525 (21)	915 (36)	1.6
600 (24)	915 (36)	1.4
750 (30)	1067 (42)	1.3
900 (36)	1219 (48)	1.2

Trench Boxes

It is good safety practice to use movable trench boxes whenever possible when installing pipe in a trench. The trench box serves as a lateral support to protect workers from possible cave-ins. They are often requirements of local labour codes.

There are two options available when using a trench box.

Option 1

Set the box directly on the trench foundation after having bottom corners removed on each side. This will allow correct placement and compaction of bedding material in the pipe zone. The box should be moved along in the direction of the excavation with the cut away section being at the back end.

Option 2

A full profile box may be used but only if it is set on ledges or shelves made in the sidewalls of the trench. These ledges should be located above the spring line of the pipe. This will create a sub-ditch condition within the trench and will ensure optimal compaction around the PVC pipe (see Figure 1).

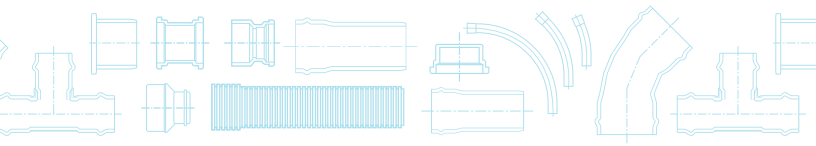

Pipe Installation Instructions Continued

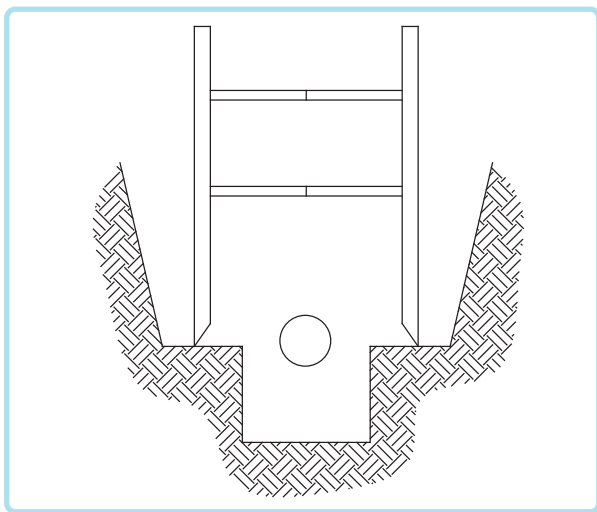

Figure 1. Trench box with sub-ditch

Preparation of Trench Bottom

The trench bottom should be constructed to provide a firm, stable and uniform support for the full length of the pipe. Ensure that the trench bottom is smooth and free of large stones, rocks, boulders, construction debris or frozen material. Bed the trench with loose granular soils such as coarse sand or crushed stone. If using heavy equipment to place bedding material into the trench, shape the material by hand afterward to eliminate any pockets and ensure the pipe is supported uniformly along its entire length.

Embedment Materials

There are a number of processed materials available for use as embedment, as well as the soil types listed under USCS Soil Classifications System (ASTM D2487), which are grouped into five broad categories according to their suitability to this application.

Class I: Manufactured angular, 6 - 38mm ($\frac{1}{4}$ " - $1\frac{1}{2}$ ") graded stone, including a number of fill materials that have regional significance such as coral, slag, cinders, crushed stone and crushed shells.

Class II: Coarse sands and gravels with maximum particle size of 38mm ($1\frac{1}{2}$ "), including variously graded sands and gravels containing small percentages of fines, generally granular and non-cohesive, either wet or dry. Soil types GW, GP, SW and SC are included in this class.

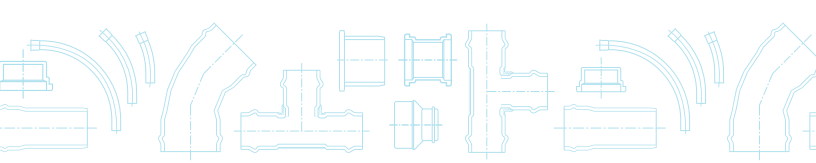

Pipe Installation Instructions Continued

Class III: Fine sand with clayey gravels, including fine sands, sand-clay mixtures and gravel-clay mixtures. Soil types GM, GC, SM and SC are included in this class.

Class IV: Silt, silty clay and clays, including inorganic clays and silts of medium to high plasticity and liquid limits. Soil types MH, ML, CH and CL are included in this class.

Class V: This class includes organic soils OL, OH and PT as well as soils containing frozen earth, debris, rocks larger than 38mm (1½") in diameter and other foreign materials. These materials are not recommended for bedding, haunching or initial backfill.

Note: The performance of a flexible conduit does not only depend on the class of embedment materials used, but more importantly, on the density achieved in compacting the haunching material.

Selection of Embedment Materials

Bedding material and its placement is of critical importance to installation of sewer pipes. It is recommended that native and imported materials be correctly classified before being used as bedding. PVC pipe should be installed with correct bedding that provides uniform longitudinal support under the pipe. Depressions for the bell should be provided at each joint to permit correct joint assembly and pipe support. Any part of the trench bottom excavated below grade should be backfilled to grade and should be compacted as required to provide firm support.

When an unstable sub-grade condition is encountered which will provide inadequate pipe support, additional trench depth should be excavated and refilled and compacted with suitable foundation material.

Correct selection of haunching material is essential to PVC pipe's ability to support vertical loads and is frequently a special material with size not exceeding 19mm (¾"). Many jurisdictions have their own bedding and initial backfill specifications, which call for specific material to be used to cover the pipe. Initial backfill material should be placed to a minimum depth of 300mm (12") over the top of the pipe.

All pipe embedment material should be selected and placed avoiding stones, frozen lumps and debris. Correct compaction procedures should be exercised to provide soil densities as specified by the design engineer.

Ledge rock, boulders and large stones should be removed to provide a minimum of 100mm (4") of soil cushion on all sides of the pipe.

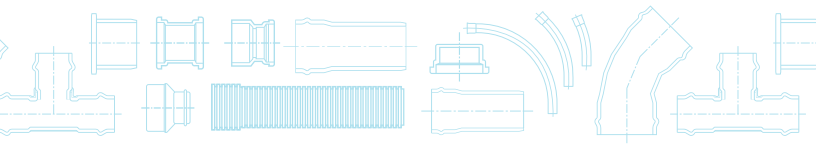

Pipe Installation Instructions Continued

Laying of Pipe and Pipe Embedment

To prevent damage, correct equipment should be used for placement of the pipe in the trench. Under no circumstances should the pipe or fittings be dropped into the trench. All foreign matter or dirt should be removed from the pipe interior. Pipe joints should be assembled with care. When pipe laying is not in progress, open ends of installed pipe should be closed to prevent water, dirt and foreign matter from getting inside the pipe. See Figure 2 for typical trench cross-section.

Foundation - is required when the trench bottom is unstable. The foundation must be able to support the pipe without causing loss of grade or structural breakage.

Bedding - is used to bring the trench bottom up to grade. Bedding materials must provide firm, stable support under the pipe. Typically 100 - 150mm (4" - 6") of compacted bedding is sufficient.

Haunching - is the most important factor affecting pipe performance and deflection. Haunching material should be placed in the haunch area so as to not cause vertical or horizontal displacement of the pipe. The material should be compacted to the density specified by the Engineer. Care must be taken to ensure compaction equipment does not touch the pipe.

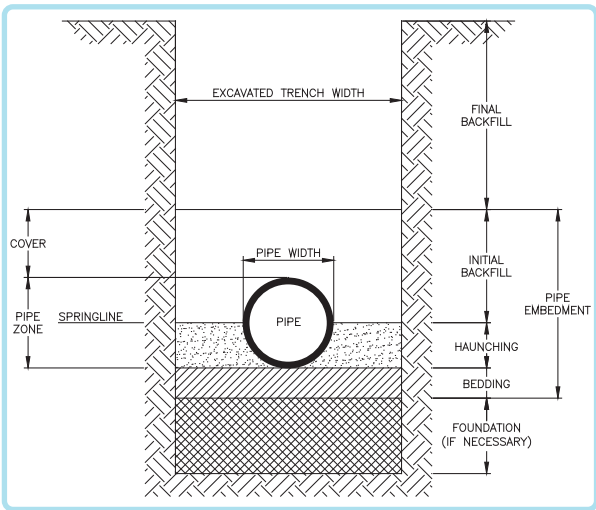
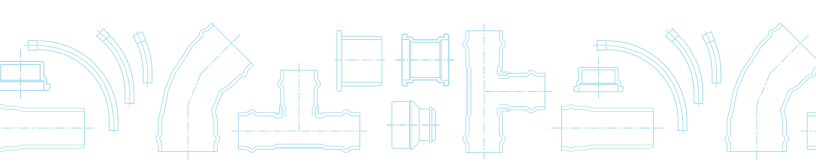

Figure 2. Typical Trench Cross-Section

Note: If the trench may be subject to flooding during construction, it may be necessary to place some initial backfill over the pipe to counteract the negative buoyancy. (ie. uplifting/floating of the pipe.)



Pipe Installation Instructions Continued

Initial Backfill - must be placed to a height between 150mm - 300mm (6" - 12") above the top of the pipe. The initial backfill shall be free of rocks which could damage the pipe. The initial backfill does not need to be compacted unless specified by the Engineer. If the pipe is being installed under a road surface and has three feet or less of cover, it is recommended that a minimum of 95% Proctor density be achieved from the bottom of the trench up to the road surface using Class I or II materials.

Final Backfill - after placement and compaction of pipe embedment materials, the balance of backfill material may be machine placed and should contain no large stones or rocks, frozen material or debris. Correct compaction procedures should be exercised to achieve soil densities as specified by the Engineer.

Pipe Assembly

For Gasketed Sewer Pipe

Clean the gasket, the bell interior and the spigot area with a cloth, brush or paper towel to remove any dirt or foreign material before assembling. Inspect the gasket and sealing surfaces for damage or deformation. Be sure that the gasket is installed correctly. Do not remove the gasket as it is locked in place during the manufacturing process. If the gasket is removed, it cannot be re-installed.

Lubricate the spigot end, using only lubricant supplied by Royal Building Products. Use of non-approved lubricants may promote bacterial growth and damage to the gaskets or the pipe, as well as void the manufacturer's warranty.

For Kor-Flo™ Pipe

Clean the gasket, the interior of the bell and the spigot area with a cloth, brush or paper towel to remove any dirt or foreign material before assembling.

Inspect the gasket and sealing surfaces for damage or deformation.

Lubricant should be applied to the interior of the bell only. Use only lubricants supplied by Royal Building Products. Use of non-approved lubricants may promote bacterial growth and damage the gaskets or pipe.

Assembly for both systems

After lubrication, the pipe is ready to be assembled. Align the spigot and bell and insert the spigot into the bell until it contacts the gasket uniformly. Do not suspend the pipe and stab it into the bell. Pipe assembly can be completed by hand using a bar and block, lever pullers or hydraulic jacks. Eagle Claw devices are acceptable for use, a backhoe bucket is not recommended.

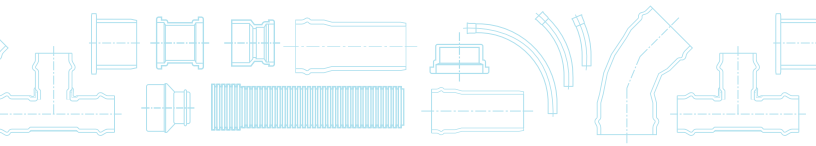

Pipe Installation Instructions

It is good practice to lay PVC pipe with bells forward (upstream). Brace the bell end while you carefully push the spigot end into the bell up to the reference mark on the spigot. Upon completion of the joint, the reference mark should be flush with the bell end of the pipe and remain visible.

DO NOT INSERT THE SPIGOT INTO THE BELL BEYOND THE INSERTION LINE.

Assembly of the joint beyond the reference mark could damage the bell or adjacent pipe, cause loss of joint flexibility and leaks, or the spigot may squeeze down into the neck of the bell and thereby reduce the pipe's internal diameter. In extreme cases, over insertion can cause either the bell or spigot to crack.

Field-Cut Pipe to Pipe

It is easier and safer to cut pipe to the exact length needed before it is placed in the trench. A square cut is essential for correct assembly. The pipe can be cut with a hacksaw, handsaw or a power saw with a steel blade or abrasive disc. It is recommended that the pipe be marked around its entire circumference prior to cutting to ensure a square cut.

For Gasketed Sewer Pipe

The insertion line should be marked on the cut piece of pipe, see Figure 3. The location of the insertion line is determined by using the pipe bell as a guide. Measure the insertion depth of the bell. This is the distance from the end of the bell to the start of the bell taper. Subtract 13mm ($\frac{1}{2}$ ") from the insertion depth distance. The result is the distance from the end of the spigot to the insertion line.

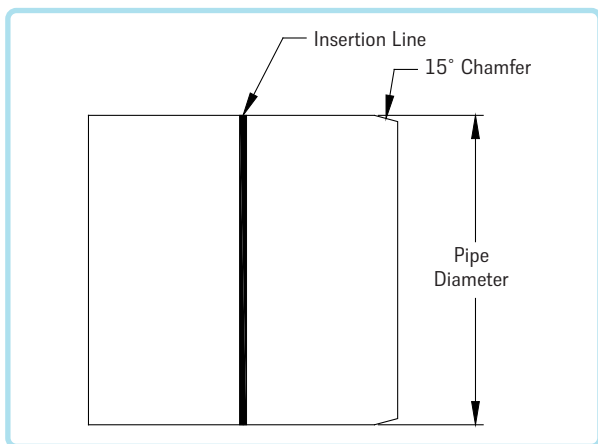
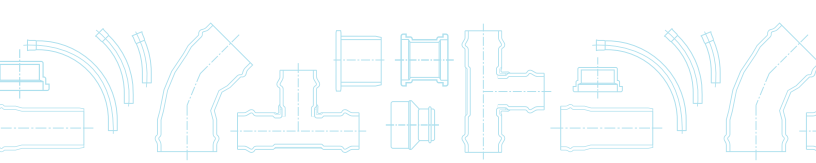

Figure 3. Insertion Line of Spigot End of Pipe



Pipe Installation Instructions Continued

Use a factory-finished beveled end as a guide for correct bevel angle and depth of bevel plus the distance to the insertion line. The end may be beveled using a pipe beveling tool or a wood rasp which will cut the correct taper. A portable sander or abrasive disc may also be used to bevel the pipe end. Round off any sharp edges on the edge of the bevel with a pocket knife or file.

For Kor-Flo™ Pipe

Measure the required length from the pipe end and cut at the mid-point between two corrugations, see Figure 4.

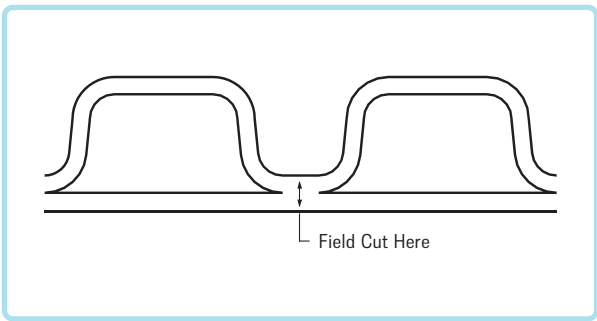

Figure 4 - Field Cut Kor-Flo™ Pipe

Kor-Flo™ gaskets are shipped on the spigot end of the pipe. If for any reason the gaskets must be placed on the pipe in the field, Kor-Flo™ gaskets should be placed in the second valley as shown in Figure 5. Ensure that the gasket is seated in the groove and is not twisted. For Kor-Flo™ sizes 200mm to 375mm (8" to 15"), 2 gaskets are required, installed in the 2nd and 3rd corrugation valley. For sizes over 450mm (18"), 1 gasket is required, installed in the 2nd corrugation valley.

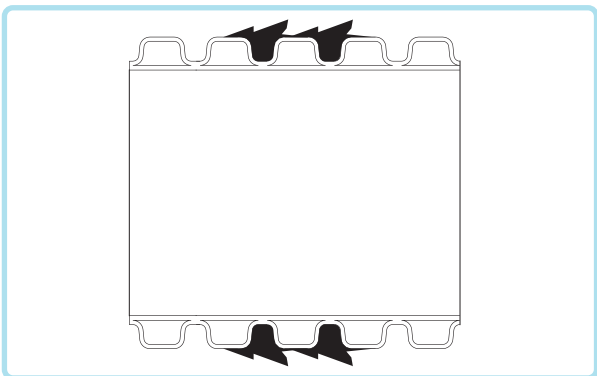
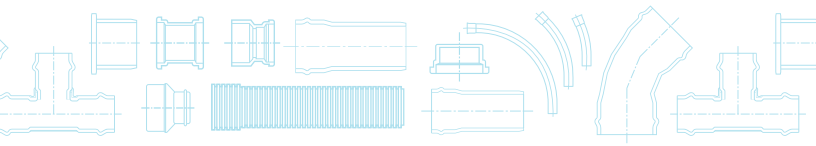

Figure 5 - Placement of Kor-Flo™ Gasket



Fittings Installation Instructions

1. Make sure the bell and spigot are clean.
2. Cut the pipe square to the required length. Remove any burrs or other sharp pieces that may harm the gasket when the pipe is inserted into the bell of the fitting.
3. When installing fittings, bevel the pipe to match that of a factory bevel. Use a piece of pipe with a factory made bevel as a guide when making field bevels. Ensure that the end of the pipe is blunt.

Bell depth may vary by manufacturer and by fitting style; injection molded or fabricated. For fabricated fittings, measure bell depth and subtract 13mm ($\frac{1}{2}$ ") for 100mm to 150mm (4" to 6") sizes and 19mm ($\frac{3}{4}$ ") for larger sizes to determine spigot insertion depth. For molded fittings, subtract 6.5mm ($\frac{1}{4}$ ") from the bell depth. Mark the insertion line at this depth. The bell depth is measured from the lip of the bell to the beginning of the taper inside the bell.

Over insertion of PVC pipe is one of the primary causes of failure for both PVC pipe and fittings. Over insertion of the spigot is characterized by a crushing of the spigot in the bell, which causes either the bell or the spigot to crack.

4. For Gasketed Sewer Pipe and STI Fittings - Lubricate the gasket and/or the chamfer on the spigot with the lubricant supplied by the manufacturer, taking care not to over-lubricate. The lubricant shall be applied in a 1mm thickness to the gasket area and/or spigot chamfer.

For Kor-Flo™ Pipe and Fittings - Lubricate the interior of the bell only.

Use only lubricants supplied by Royal Building Products. Use of non-approved lubricants may promote bacterial growth and damage the gaskets or pipe.

5. Check again that the bell and spigot are still free of debris, and then place the spigot at the bell lip positioning the spigot such that the chamfer is resting against the edge of the gasket. Then, push the spigot into the bell until the assembly line on the spigot is even with the lip of the bell.

Note: Always keep a piece of wood between the face of the pipe bell and any mechanical means used for pushing. This protects the pipe as well as ensures even distribution of the force pushing the pipe into the bell.

Fittings Installation Instructions Continued

- For small diameters up to 375mm (15"), the assembly should be possible by hand using a block and bar. Never push directly against the pipe. Eagle Claw-type joining devices are acceptable for use.
- For larger diameters, mechanical assembly methods may be required such as a come-along, jack, or pulley. A backhoe bucket is not recommended.

Sewer Laterals

Service laterals should be taken off at an angle not greater than 45° from the horizontal, see Figure 6. If for any reason the service lateral must exceed 45° from the horizontal, please contact the municipality and Royal for proper installation details.

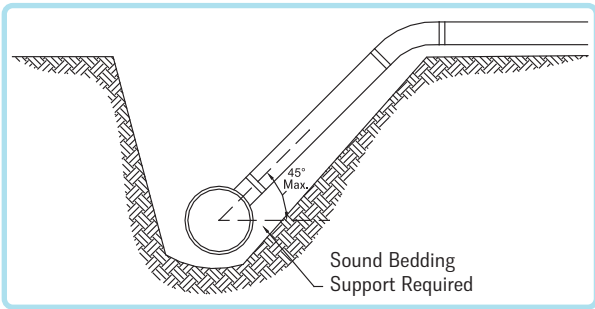

Figure 6. Service Laterals

For deep sewer laterals, sewer risers are often used to minimize excavation for the lateral piping. When installing PVC riser pipes on a PVC sewer line, the following guidelines should be followed:

- Align the lateral exit from the main at not greater than 45° from horizontal.
- Achieve good compaction in the haunching area from the base to the springline of the fitting and sewer main; use select material if necessary.
- Ensure uniform support at the riser pipe connection by uniform bedding with good compaction all around and up the pipe.
- Where possible, use long sweep PVC bends to make the slope changes more gradual.

Royal Municipal Solutions also manufactures 2 products that help prevent damage to sewer tees due to settlement of deep sewer laterals:

Controlled Settlement Joint - This fitting, available in 100mm, 135mm and 150mm (4", 5" and 6") sizes, allows movement of the sewer lateral in a controlled manner.

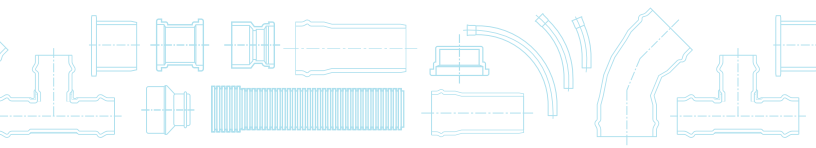

Fittings Installation Instructions Continued

Vertical Riser Kit - This kit includes numerous fittings, which prevent settlement damage to sewer fittings.

Details of these 2 Royal products are available in the product brochures.

Change Of Direction

There are three methods that can be used to create a change of direction in the pipeline:

1. Using Royal PVC fittings
2. Deflecting the pipe at the joint
3. Bending the pipe

1. Royal PVC Fittings - Royal offers standard elbows and long radius bends in 11¼°, 22½°, 45° and 90° angles to accomplish changes in direction

2. Deflecting the Pipe at the Joint - The joints of Royal sewer pipe are flexible to permit limited directional changes. Do not use both bending the pipe and deflecting the joint at the same time in order to maximize the amount of curvature.

Procedure:

- a. Assemble the pipe in the usual manner but stop the pipe insertion 13mm (½") from the insertion line.
- b. Offset the assembled length of pipe to the required amount of deflection, not exceeding the offsets shown in Table 4. Achieve the offset manually. Do not use a backhoe bucket. For reference purposes, 1° of deflection is equal to 71mm (2.8") for 4.27m (14') length of sewer pipe.

Table 4 - Maximum Offset for Joint Deflection

Pipe Size mm (in)	Angle at Bell (°)	Maximum Offset per Pipe Length mm (in)
Gasketed Sewer Pipe		
100 - 300 (4 - 12)	5	350 (14)
375 - 600 (15 - 24)	3	213 (8.4)
675 (27)	1.5	107 (4.2)
Kor-Flo™ Pipe		
200 - 450 (8 - 18)	5	350 (14)
525 - 600 (21 - 24)	3	213 (8.4)
750 - 900 (30 - 36)	1.5	107 (4.2)

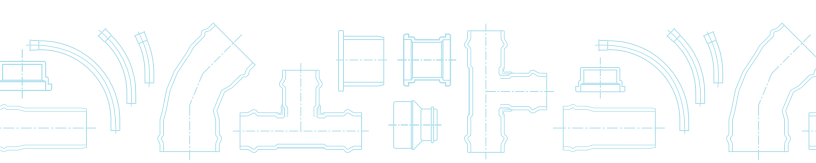

Fittings Installation Instructions Continued

3. Bending the Pipe - This method is acceptable for Gasketed Sewer pipe up to 375mm (15"). It should not be used with any size of Kor-Flo™ pipe.

Procedure:

- a. Assemble the pipe as described before. Keep the spigot in straight alignment with the pipe.
- b. Place compacted backfill around the joints to restrict any movement.
- c. Place compacted backfill at the inside of the curve at the mid-point of the pipe.
- d. Manually move the leading bell, but do not exceed offset distance and radius of curvature specified in Table 3 below.

Table 3 - Minimum Radius of Curvature and Maximum Offset for Bending the Pipe

Nominal Pipe Size mm (in)	Minimum Radius of Curvature m (ft)	Maximum Offset for Bending the Pipe mm (in)
100 (4)	17 (56)	430 (17)
135 (5)	22 (72)	350 (14)
150 (6)	25 (82)	310 (12)
200 (8)	33 (108)	230 (9)
250 (10)	42 (138)	180 (7)
300 (12)	50 (164)	150 (6)
375 (15)	61 (200)	130 (5)

Manhole Connections

The connections between PVC sewer pipe and concrete manholes must be watertight. The following describes how these connections can be made for Gasketed Sewer pipe and Kor-Flo™ pipe.

1. Gasketed Outlet - Pre-cast concrete manholes are available with a gasketed outlet to accommodate smooth wall sewer pipe. The installer must specify the outside diameter of the pipe to ensure the correct gasket is cast into the manhole. For Kor-Flo™ pipe, a smooth wall adapter must be used.
2. Grout Adapters - Grout Adapters are stubs of PVC pipe that have been coated with a sand, epoxy and cement mortar mix. A watertight connection is made by inserting the grout adapter into the manhole outlet and filling in the void between the adapter and the outlet with non-shrink grout.

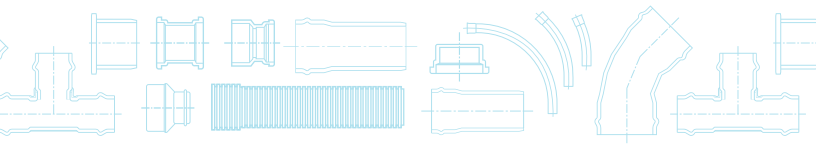

Fittings Installation Instructions Continued

For Kor-Flo™ Pipe Only

3. Straight Connection - Non-shrink grout will bond to elastomeric gaskets, therefore a watertight connection can be made between the gasket on the outside of the spigot end of the pipe and the manhole outlet.

Note: Ensure that the manhole and connecting pipe have stable foundation and bedding to prevent shifting or settling which could damage the connection.

Service Connections

There are two methods of connecting PVC sewer pipe to services or tie-ins. Royal recommends that PVC fittings be used for service connections, for both new and existing construction. Inserta-Tees can also be used for tie-ins to existing construction.

1. Royal PVC Fittings - Royal manufactures a complete line of fittings up to 900mm (36") for both Gasketed Sewer pipe and Kor-Flo™ pipe. See the section on FITTINGS INSTALLATION (page 16) for installation details.

2. Inserta-Tees - Fat Boy Inserta-Tees can be used on both Gasketed Sewer pipe and Kor-Flo™ pipe. They can be installed on mainlines up to 900mm (36") with outlet sizes from 100mm - 375mm (4" - 15").

Installation Procedure:

a. Core the correct size hole for the Inserta-Tee in the mainline pipe. For 525mm (21") Kor-Flo™ and larger a deep shank, blue hole saw is recommended.

Table 5: Hole Diameters for Inserta-Tees

Inserta-Tee Size mm (in)	Hole Diameter mm (in)
100 (4)	113 (4-1/2)
150 (6)	163 (6-1/2)
200 (8)	219 (8-3/4)
250 (10)	272 (10-7/8)
300 (12)	322 (12-7/8)
375 (15)	395 (15-13/16)

b. Insert the rubber sleeve into the cored hole with the GOLD VERTICAL LINE on the rubber sleeve facing toward the side of the mainline pipe. The upper segment should be on top of the wall or rib and the lower segment should be on the inside of the mainline pipe.

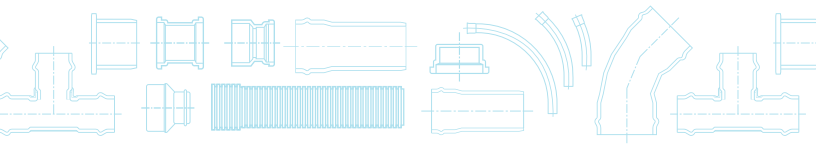

Service Connections Continued

- c. Apply the Inserta-Tee solution supplied to the inside of the rubber sleeve and the outside of the PVC hub adapter. **Caution: Do not use pipe lubricant, the hub adapter will not stay in place.**
- d. Place the PVC hub adapter into the rubber sleeve. Align the RED VERTICAL LINE on the PVC hub adapter with the GOLD VERTICAL LINE on the rubber sleeve.
- e. Place a 2 x 4 board on top of the PVC hub adapter and tap the PVC hub adapter down into the rubber sleeve until the HORIZONTAL RED LINE on the PVC hub adapter meets the top of the rubber sleeve.
- f. Place the stainless steel band around the top of the rubber sleeve and tighten down.
- g. Install the lateral connection pipe in the normal manner.

When making any type of service connection, ensure that:

- No foreign material enters the main line pipe through the connection outlet.
- The outlet is plugged until the service lateral pipe is installed.
- The lateral service pipe is capped at its terminating point until the house sewer line is installed.

If you have any questions about installing PVC fittings or Inserta-Tees, please contact your Royal representative.

Testing Sewer Mains

Testing Sewer Mains

After installation of a sewer main, each run of pipe between manholes should be tested. The Design Engineer will specify the test to be used, and the location and extent of each test.

Joint Tightness Test

This test ensures the integrity of the assembled gasketed joints. There are two methods of testing: air testing or hydrostatic testing. Air testing is the preferred method as it is accurate, simple, fast and does not require filling the sewer main with water.

Air Testing

The ends of the test section are plugged and the test section is subjected to low pressure air. The air must be maintained at a minimum pressure of 24kPa (3.5psi) for a specified period of time. See Table 6 for time periods. The maximum permitted pressure drop for the specified time period is 3.5kPa (0.5psi). If this pressure drop is exceeded, the installer must locate and fix any leaks. The section must then be re-tested to ensure that the leaks have been repaired.

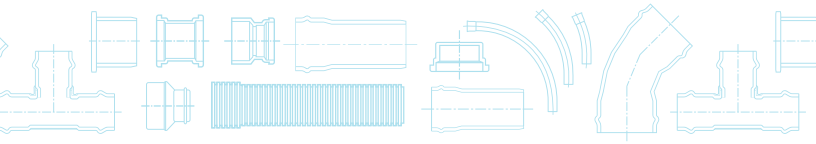

Testing Sewer Mains Continued

Table 6 - Time Required for 3.5kPa (0.5psi) Pressure Drop

Pipe Size mm (in)	Time Required for 3.5kPa (0.5psi) Pressure Drop					
	Minimum Time min:sec	Length of Pipe for Minimum Time		Time for Longer Lengths, sec		
		Pipe Length (ft)	Pipe Length (m)	Length (L) in m	Length (L) in ft	
100 (4)	1:53	597	182	0.623L	0.190L	
150 (6)	2:50	398	121	1.401L	0.427L	
200 (8)	3:47	298	91	2.493L	0.760L	
250 (10)	4:43	239	73	3.894L	1.187L	
300 (12)	5:40	199	61	5.606L	1.709L	
375 (15)	7:05	159	48	8.761L	2.671L	
450 (18)	8:30	133	41	12.615L	3.846L	
525 (21)	9:55	114	35	17.171L	5.235L	
600 (24)	11:20	99	30	22.425L	6.837L	
675 (27)	12:45	88	27	28.382L	8.653L	
750 (30)	14:10	80	24	35.049L	10.683L	
900 (36)	17:00	66	20	50.472L	15.384L	

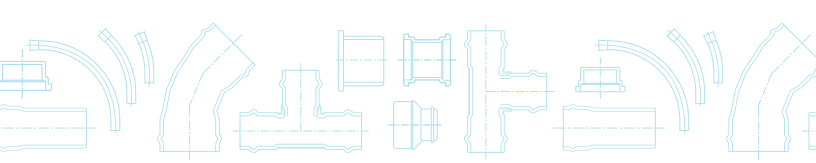

Testing Sewer Mains Continued

Low pressure air shall be slowly introduced into the sealed line until the internal air pressure reaches 4.0psi greater than the average back pressure of any groundwater above the pipe, but not greater than 9.0psi.

Hydrostatic Testing

Infiltration - This method can only be used if the groundwater level is above the top of the pipe for the entire test section. The Engineer will give specific instructions on how this test should be conducted. Infiltration cannot exceed the maximum allowable rate of infiltration specified.

Exfiltration - This method can be used when the groundwater level is low enough that the test pressures can exceed the static head of the water table. Test pressures should be a minimum of 5.9kPa above the water table head. The test section is filled with water and the leakage rate is measured. To pass, the leakage rate must not exceed the maximum allowable, as specified by the Engineer.

Should the allowable rate for either test method be exceeded, the installer must locate and repair any leaks until the test is passed successfully.

Closed Circuit TV Inspection

Closed circuit television inspections can be done on the pipeline. This method can detect noticeable installation problems such as leaking joints or excessive deflection. However, the video cannot quantify these problems if they exist.

Properly assembled pipe will show a joint gap (see Figure 7). Over-inserted spigots, which are contacting the back of the bell can cause leaks or structural failure of either the bell or the spigot.

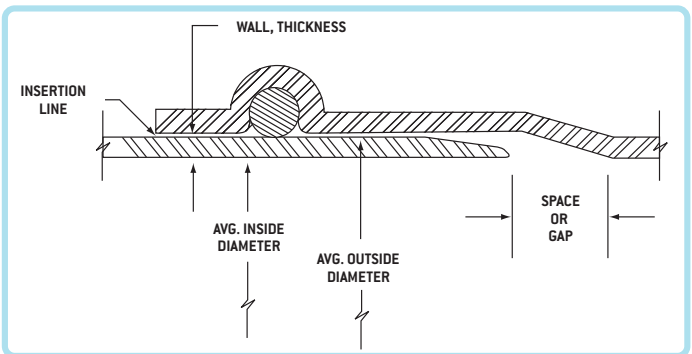
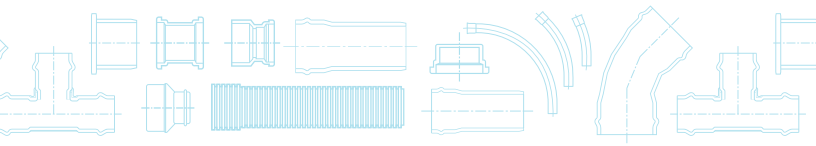

Figure 7. Illustration shows a cross-section of PVC pipe joint.



Pipe and Joint Deflection

Deflection is defined as the change in inside diameter of a flexible pipe when subjected to vertical load. The amount of deflection that will occur is a function of:

1. Pipe stiffness
2. Soil density
3. Load on the pipe

To limit pipe deflection, soil density plays the most important role, especially in the haunching area. Pipe deflection can be calculated using the Modified Iowa Formula or other methods which have also been developed. Table 3 represents field measurements taken under different soil types, soil density and height of cover.

Inspection and Testing

If there is a requirement for monitoring vertical deflection to ensure that the requirements of the specification are met, the most common and least expensive method in use is the rigid “Go-No-Go” mandrel device. This device is pulled through the line and measures on only a “Go-No-Go” basis.

When using a “Go-No-Go” device to check deflection, several steps should be followed:

1. Ensure that the line is free and clear of debris that might cause the device to jam. It is recommended that the line be cleaned with a hydro-cleaner, washing in the direction of the flow.
2. Pull a line through the pipe to pull the “Go-No-Go” device. This can be done several ways:
 - a. If a hydro-cleaner is being used, attach the pull line to the nozzle end before the actual cleaning cycle starts. As the hose is carried through the line, it will carry the pull line with it. When the hose nozzle reaches the manhole, disconnect the pull line and tie it off.
 - b. A parachute device can be blown through the line with a lightweight string attached. Detach the string and then attach the pull line. Manually drag the pull line through the pipe. Tie off at the manhole.
 - c. If the sewer line is in service, a string can be floated through the manhole run. When the string reaches the next manhole, attach it to the manhole and drag it through. Tie the pull line off at the manhole.

Table 7 - Long Term Deflection (46 psi, 320 kPa)

ASTM Embedment Material Classification	Proctor Density (AASHTOT-99)	Height of Cover m (ft)													
		0.9 (3.0)	1.5 (5.0)	2.4 (8.0)	3.0 (10.0)	3.7 (12.0)	4.3 (14.0)	4.9 (16.0)	5.5 (18.0)	6.1 (20.0)	6.7 (22.0)	7.3 (24.0)	7.9 (26.0)	8.5 (28.0)	9.1 (30.0)
Class I - Manufactured Granular Angular	90%	0.2	0.3	0.4	0.5	0.6	0.7	0.9	1.0	1.1	1.2	1.3	1.4	1.5	1.6
Class II - Clean Sand & Gravel	90%	0.2	0.3	0.5	0.7	0.8	0.9	1.1	1.2	1.3	1.4	1.6	1.7	1.8	2.0
	80%	0.9	1.4	2.3	3.2	3.6	4.1	5.0	5.5	6.0	6.4	7.3	7.7	8.2	9.1
	90%	0.2	0.4	0.6	0.8	0.9	1.1	1.2	1.4	1.6	1.7	1.9	2.1	2.2	2.3
Class III - Sand and Gravel with Fines	85%	0.7	0.9	1.7	2.2	2.6	3.0	3.5	3.9	4.3	4.8	5.2	5.6	6.0	6.5
	75%	1.1	1.8	2.9	3.8	4.5	5.5	6.8	8.5	9.9	11.3	12.7	14.1	15.5	16.8
	65%	1.3	2.4	3.6	4.7	5.5	6.8	8.5	9.6	11.4	13.0	14.5	16.0	17.3	18.0
	85%	0.7	0.9	1.7	2.2	2.6	3.0	3.5	3.9	4.3	4.8	5.2	5.6	6.0	6.5
Class IV - Silt and Clay	75%	1.3	2.3	3.3	4.3	5.0	6.5	7.8	9.5	10.6	12.2	13.5	15.0	16.3	17.0
	65%	1.3	2.4	3.6	4.7	5.5	8.0	10.5	12.5	15.0	17.6	20.0	22.0	24.0	26.0

Soil conditions are acceptable for this height of cover.

Soil conditions are not recommended for this height of cover.

1. Test data indicates no pipe installed under conditions specified will deflect more than is indicated; pipe will deflect less than the amount indicated if specified density is obtained.
2. Bedding classifications are in accordance with ASTM D2321.
3. For burial depths not shown, please contact Royal Building Products Technical Services department.

Pipe and Joint Deflection Continued

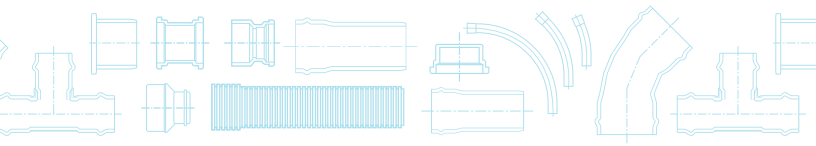

Pipe and Joint Deflection Continued

3. Pulling of the mandrel device is done by hand. The pulling motion should be smooth and easy to avoid jamming if an obstruction is encountered in the line. The mandrel should have a line on each end to facilitate removal should it become obstructed in the direction of the pull. If the mandrel device stops, lightly pull on it to see if it will clear the obstruction. If it will not go forward, record the distance from the manhole where the mandrel is stuck and then pull it back out.

If there is a requirement for deflection testing, both designer and installer should be aware of the following recommendations:

1. The recommended long-term deflection limit for sewer pipe systems is established by the local governing authority. The maximum amount of deflection allowed is expressed as a percentage of the pipe's Base Inside Diameter. The base inside diameter is calculated as noted in CSA B182.2 Annex B, ASTM D3034 Appendix X1 and ASTM F679 Appendix X2.

Table 8 shows Base Inside Diameter and 7.5% Deflection.

2. The least expensive method of measuring the deflection is by using a Go No-Go device. The owner, engineer and/or contractor are responsible for supplying the measurement device and conducting the deflection testing.

Installing Pipe Through Casings

In specific applications, it may be beneficial to install the pipe in a protective casing. The suggested method for installing pipe in a casing is given below. It is critical to ensure that:

- The appropriate size of casing is used.
- Spacers and skids are attached to the PVC pipe.
- The friction force during the pull is minimized.
- A water-permeable seal is installed at each end of the casing.

Size of Casing

The inside diameter of the casing shall be large enough to easily accommodate the outside diameter of the pipe bells and the projections of the casing spacers.

Casing Spacers

The pipe should not rest on the bells after being installed in the casing. Casing spacers are available that are designed to support the pipe and contents while centering the pipe inside the casing. There are several manufacturers of this type of spacers. For spacer installation instructions, refer to the spacer manufacturer.

Pipe and Joint Deflection

Table 8 - Base Inside Diameter and 7.5% Mandrel Deflection

Trade Size	Base Inside Diameter and 7.5% Mandrel Deflection																	
	SDR28						SDR35						Kor-Flo™					
	Average ID mm	Average ID in	Base Inside Diameter mm	Base Inside Diameter in	7.5% Deflection Mandrel mm	7.5% Deflection Mandrel in	Average ID mm	Average ID in	Base Inside Diameter mm	Base Inside Diameter in	7.5% Deflection Mandrel mm	7.5% Deflection Mandrel in	Average ID mm	Average ID in	Base Inside Diameter mm	Base Inside Diameter in	7.5% Deflection Mandrel mm	7.5% Deflection Mandrel in
4	99.95	3.896	96.78	3.810	89.52	3.524	100.57	3.959	98.40	3.874	91.02	3.583	-	-	-	-	-	-
5	132.40	5.213	129.48	5.098	119.77	4.718	134.58	5.298	131.71	5.185	121.83	4.797	-	-	-	-	-	-
6	147.31	5.800	144.07	5.672	133.26	5.246	149.73	5.895	146.50	5.768	135.51	5.335	-	-	-	-	-	-
8	-	-	-	-	-	-	200.42	7.891	196.11	7.721	181.40	7.142	200.41	7.890	196.11	7.721	181.40	7.142
10	-	-	-	-	-	-	250.55	9.864	245.16	9.652	226.77	8.928	250.55	9.864	245.19	9.653	226.80	8.929
12	-	-	-	-	-	-	298.27	11.743	291.86	11.491	269.97	10.629	298.13	11.737	291.75	11.486	269.87	10.625
15	-	-	-	-	-	-	365.09	14.374	357.25	14.065	330.46	13.010	365.09	14.374	357.28	14.066	330.48	13.011
18	-	-	-	-	-	-	446.23	17.568	436.64	17.191	403.89	15.901	448.31	17.650	438.70	17.272	405.80	15.976
21	-	-	-	-	-	-	526.08	20.712	514.77	20.267	476.16	18.747	527.05	20.750	515.75	20.305	477.07	18.782
24	-	-	-	-	-	-	591.84	23.301	579.11	22.800	535.68	21.090	596.90	23.500	584.17	22.999	540.36	21.274
27	-	-	-	-	-	-	666.99	26.259	652.64	25.694	603.69	23.767	-	-	-	-	-	-
30	-	-	-	-	-	-	-	-	-	-	-	-	749.30	29.500	734.14	28.903	679.08	26.735
36	-	-	-	-	-	-	-	-	-	-	-	-	901.70	35.500	883.46	34.782	817.20	32.173

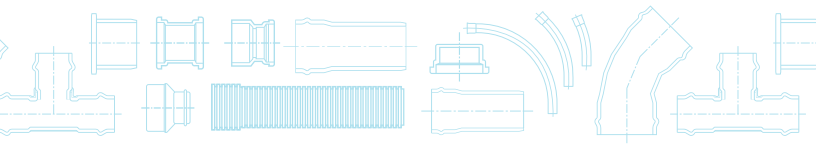

Installing Pipe Through Casings Continued

Installation

Once the spacers are attached to the pipe, the pipe can be pulled through the casing. Feed a cable through the casing and the first length of pipe and attach the cable to a wood cross piece placed over the face of the pipe. Pull the pipe through the casing. Repeat this procedure until complete. Ensure that the pull is slow and steady.

Lubricating the spacers and/or casing bottom will assist with a slow uniform installation.

Grouting the Annular Space

Once the pipe has been inserted into the casing, backfilling of the annular space can be completed, if specified by the Design Engineer. Care must be taken during backfilling to protect the pipe:

1. Grout Placement

Grout must be placed so that the level of grout on all sides of the pipe is even as the space is filled. Uneven placement of grout can cause distortion of the pipe.

2. Grout Pressure

Excess grout pressure can cause distortion or collapse of the pipe. The maximum allowable grouting pressure for SDR35 pipe is 83Kpa (12psi) at 23°C (73°F). If the pipe wall temperature rises above 23°C, maximum allowable grout pressures must be reduced.

Prior to grouting operation commences; fill the pipe with water to prevent collapse.

Sealing the Casing Ends

After the pipeline has been tested, the entry and exit points of the casing should be sealed with a permeable grout.

Do not use Kor-Flo™ pipe for this application.

See Actual Charts on pages 28 and 29 for reference.

Disclaimer: The information contained herein is believed to be reliable, however, Royal Building Products does not represent and/or warrant the information.

Dimensions

Table 9 - Dimensions of Royal Municipal Solutions Gasketed Sewer Pipe

Royal Municipal Solutions Gasketed Sewer Pipe						
Standard Dimension Ratio (SDR)	Nominal Size mm (in)	Average Inside Diameter mm (in)	Average Wall Thickness mm (in)	Average Outside Diameter mm (in)	Average Bell Depth mm (in)	Bell Outside Diameter mm (in)
SDR28	100 (4)	99 (3.899)	4 (0.158)	107 (4.125)	89 (3½)	127 (5.000)
	135 (5)	133 (5.218)	5 (0.211)	143 (5.640)	102 (4)	166 (6.535)
	150 (6)	147 (5.799)	6 (0.238)	159 (6.275)	114 (4¼)	184 (7.244)
SDR35	100 (4)	101 (3.957)	3 (0.129)	107 (4.125)	89 (3½)	126 (4.961)
	135 (5)	135 (5.298)	4 (0.171)	143 (5.640)	102 (4)	165 (6.496)
	150 (6)	149 (5.893)	5 (0.191)	159 (6.275)	108 (4¼)	184 (7.244)
	200 (8)	201 (7.894)	6 (0.253)	213 (8.400)	140 (5½)	242 (9.528)
	250 (10)	251 (9.866)	8 (0.317)	267 (10.500)	165 (6½)	301 (11.850)
	300 (12)	298 (11.740)	10 (0.380)	318 (12.500)	184 (7¼)	359 (14.134)
	375 (15)	365 (14.378)	12 (0.461)	389 (15.300)	191 (7¾)	429 (16.890)
	450 (18)	447 (17.573)	14 (0.564)	475 (18.701)	241 (9 1/2)	527 (20.748)
	525 (21)	526 (20.713)	17 (0.667)	560 (22.047)	260 (10¼)	615 (24.212)
600 (24)	592 (23.303)	19 (0.750)	630 (24.803)	279 (11)	692 (27.244)	
675 (27)	667 (26.263)	21 (0.827)	710 (27.953)	305 (12)	776 (30.551)	

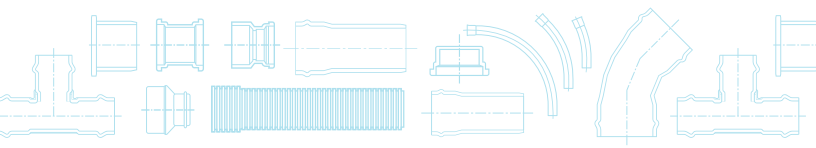

Dimensions Continued

Table 10 - Dimensions of Kor-Flo™ Profile Pipe

Kor-Flo™ Profile Pipe			
Nominal Size mm (in)	Average Inside Diameter mm (in)	Average Outside Diameter mm (in)	Average Bell Depth mm (in)
200 (8)	200 (7.891)	218 (8.600)	127 (5.000)
250 (10)	250 (9.863)	274 (10.786)	152 (6.000)
300 (12)	298 (11.729)	325 (12.795)	165 (6.500)
375 (15)	365 (14.374)	398 (15.658)	191 (7.500)
450 (18)	448 (17.649)	486 (19.152)	203 (8.000)
525 (21)	527 (20.750)	573 (22.580)	216 (8.500)
600 (24)	597 (23.514)	650 (25.585)	279 (11.000)
750 (30)	749 (29.498)	817 (32.150)	317 (12.500)
900 (36)	901 (35.487)	984 (38.762)	330 (13.000)

Conversion Chart

feet	to metres	0.3048
metres	to feet	3.2808
miles	to kilometres	1.6093
kilometres	to miles	0.6214
inches	to millimetres	25.400
millimetres	to inches	0.0394
U.S gallon	to cubic metre	0.003785
cubic metre	to U.S gallon	264.1728
cubic yard	to cubic metre	0.7645
cubic metre	to cubic yard	1.3079
pound (force)	to newton	4.4482
newton	to pound (force)	0.2248
pound (mass)	to kilogram	0.4536
kilogram	to pound (mass)	2.2046
psi	to kilopascal	6.8947
kilopascal	to psi	0.1450
US gpm	to cu. ft./sec	0.0022
cu. ft./sec	to US gpm	448.8306
US gpm	to litres/sec	0.0631
litres/sec	to US gpm	15.8503
ft•lb (force)	to N•m	1.3558
N•m	to ft•lb (force)	0.7375
lb/ft	to kg/m	1.4882
kg/m	to lb/ft	0.6721

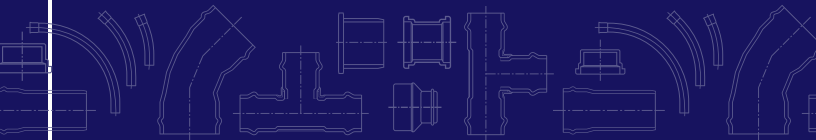

Our various pipe and fittings solutions have been manufactured to meet the needs of our customers and their applications. Contact one of the below Sales Centres for more information:

- Municipal Pipe & Fittings Solutions
- Plumbing Pipe & Fittings Solutions
- Electrical Pipe & Fittings Solutions
- Industrial Pipe & Fittings Solutions
- Irrigation Pipe & Fittings Solutions

Sales & Distribution Centres:

Surrey, BC, Canada
T/F 1.800.663.0696
F 1.800.663.6564
.....

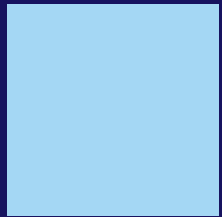

Woodbridge, ON, Canada
T/F 1.866.769.7473
F 905.856.3986
.....

Laval, QC, Canada
T/F 1.800.465.9754
F 450.688.6624
.....



Distribution Centres:

Calgary, AB, Canada
T/F 1.800.663.0696
F 1.800.663.6564
.....

Winnipeg, MB, Canada
T/F 1.800.663.0696
F 1.800.663.6564
.....



royalbuildingproducts.com

M- GASKETED-IGV3
Printed 01.2013