

Features

- Fits minimum 36" (914 mm) apron sink base cabinet.
- 9-1/2" depth provides generous workspace.
- Shortened apron allows sink to be used in most standard cabinetry or retrofitted to existing standard cabinetry.
- Plain front design.
- Matte finish offers rich, dimensional color.
- Solid color throughout the sink.
- Scratch, stain, chip, and thermal-shock resistant.
- Offset drain increases workspace in the sink and storage space underneath.
- Self-Trimming® apron overlaps cabinet face for easy installation and beautiful results.

Material

- KOHLER Neoroc® composite is durable and built to withstand day-to-day cleaning tasks.
- Heat-resistant up to 750°F.

Installation

- Undermount.

Recommended Products/Accessories

- K-8801 Sink drain and strainer with tailpiece
- K-8799 Sink drain and strainer basket

Optional Products/Accessories

- K-11352 Disposal Flange with Stopper
- K-9000 P-Trap

Included Components

Additional Components:

- K-26026 Farmhouse kitchen sink towel hook
- K-30182 Sink racks



Codes/Standards









CSA B45.5/IAPMO Z124

KOHLER® Neoroc® Sinks Lifetime Limited Warranty

See website for detailed warranty information.

Available Colors/Finishes

Color tiles intended for reference only.

Color	Code	Description
	CM6	Matte White
	CM7	Matte Graphite
	CM5	Matte Beige
	CM8	Matte Black Plum
	CM1	Matte Black
	CM2	Matte Brown
	CM3	Matte Taupe
	CM4	Matte Grey

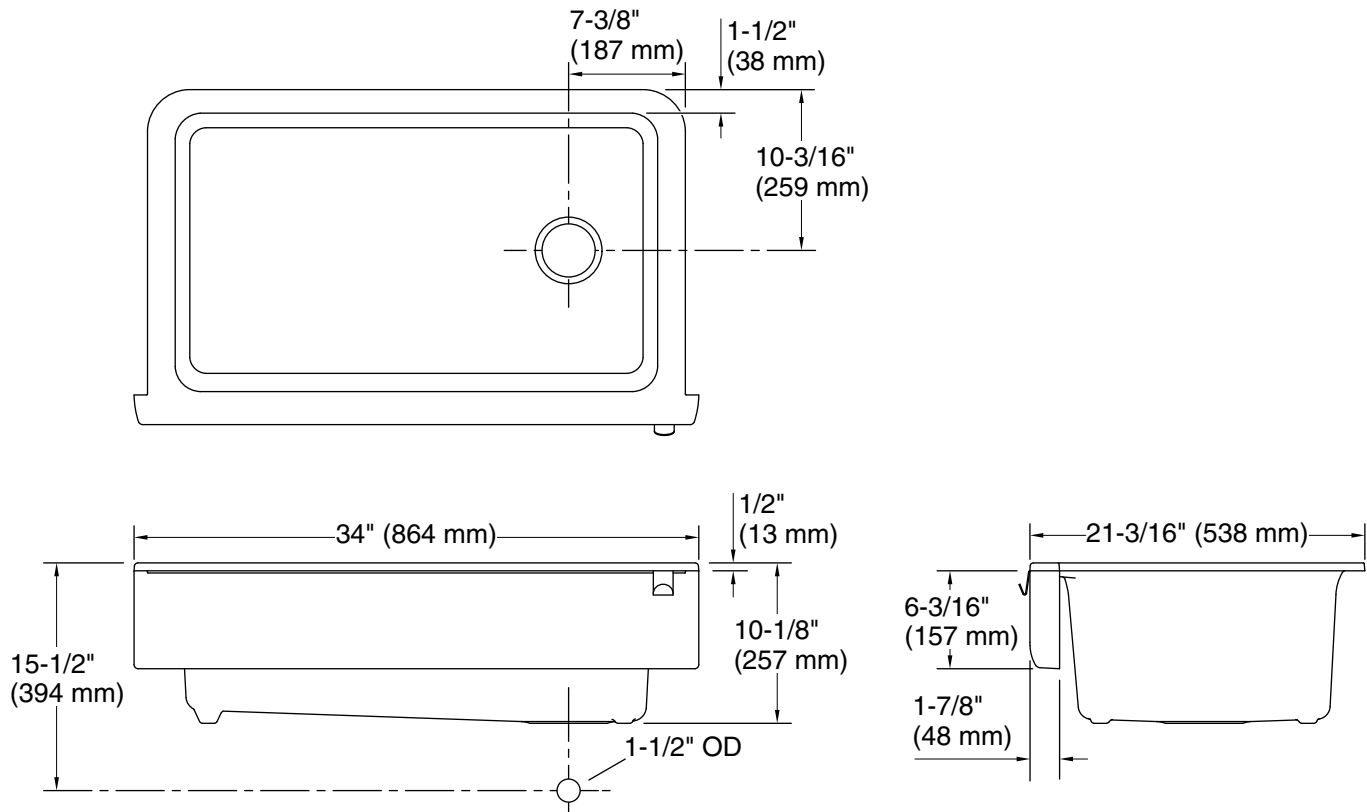

Technical Information

All product dimensions are nominal.

Bowl configuration:	Single
Installation:	Undermount
Min. base cabinet width:	36" (914 mm)
Bowl area (Only):	Length: $28\frac{5}{8}$ " (726 mm) Width: $15\frac{1}{2}$ " (394 mm) Bowl depth: $9\frac{1}{2}$ " (241 mm) Water depth: $9\frac{1}{2}$ " (241 mm)
Drain hole:	$3\frac{7}{8}$ " (98 mm)
Template:	Apron-front, 1400299-7, required, included

Notes

Install this product according to the installation instructions.