

Features

- Real Rain Diverter Valve system actuates Real Rain's Deluge function delivering approximately 0.5 gallons in eight seconds
- Real Rain Diverter Trim kit contains both a round and square escutcheon for different design options
- Required for the K-76746 Real Rain diverter valve

Material

- Premium metal construction for durability and reliability
- KOHLER finishes resist corrosion and tarnishing

Installation

- Real Rain Diverter Valve is designed to be in-line between the shower valve and Real Rain Panel

Required Products/Accessories

K-76728 overhead panel
K-76732 Overhead Panel Trim
K-76746 Diverter Valve

Recommended Products/Accessories

K-23723 Faucet cleaner



Codes/Standards









ASME A112.18.1/CSA B125.1
ADA
ICC/ANSI A117.1
CSA B651
OBC

KOHLER® Faucet Lifetime Limited Warranty

See website for detailed warranty information.

Available Colors/Finishes

Color tiles intended for reference only.

Color	Code	Description
	CP	Polished Chrome
	SN	Vibrant® Polished Nickel
	BN	Vibrant® Brushed Nickel
	BV	Vibrant® Brushed Bronze
	2BZ	Oil-Rubbed Bronze
	BL	Matte Black
	2MB	Vibrant® Brushed Moderne Brass
	TT	Vibrant Titanium

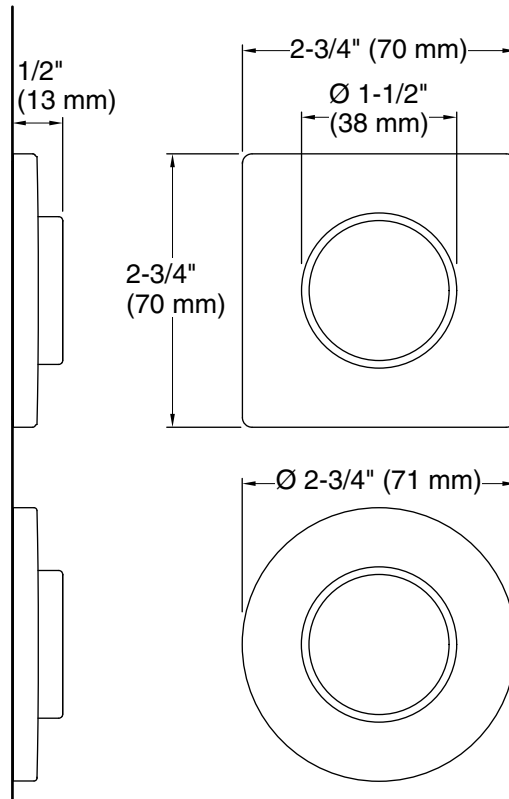

Technical Information

All product dimensions are nominal.

Drain included: No

Notes

Install this product according to the installation instructions.

ADA, OBC, CSA B651 compliant when installed to the specific requirements of these regulations.