

Features

- Overhanging lid design creates a clean and sleek look.
- Quiet-Close™ elongated seat closes quietly.
- Grip-Tight bumpers hold seat firmly in place.
- Quick-Release™ functionality allows seat to be removed easily from toilet for convenient cleaning.
- Quick-Attach® hardware for fast and secure installation.
- Color-matched plastic hinges.
- Round closed-front seat.
- Contoured seat for user comfort.
- Elegant lid design for a clean and sleek aesthetic.

Material

- Plastic construction.

Installation

- For nonresidential application, K-7673, K-20111, or K-25302 is recommended.



Codes/Standards









None Applicable

KOHLER® One-Year Limited Warranty

See website for detailed warranty information.

Available Colors/Finishes

Color tiles intended for reference only.

| Color | Code | Description |
|---|------|---------------|
|  | 0 | White |
|  | 96 | Biscuit |
|  | NY | Dune |
|  | 95 | Ice™ Grey |
|  | G9 | Sandbar |
|  | K4 | Cashmere |
|  | 58 | Thunder™ Grey |
|  | 7 | Black Black™ |

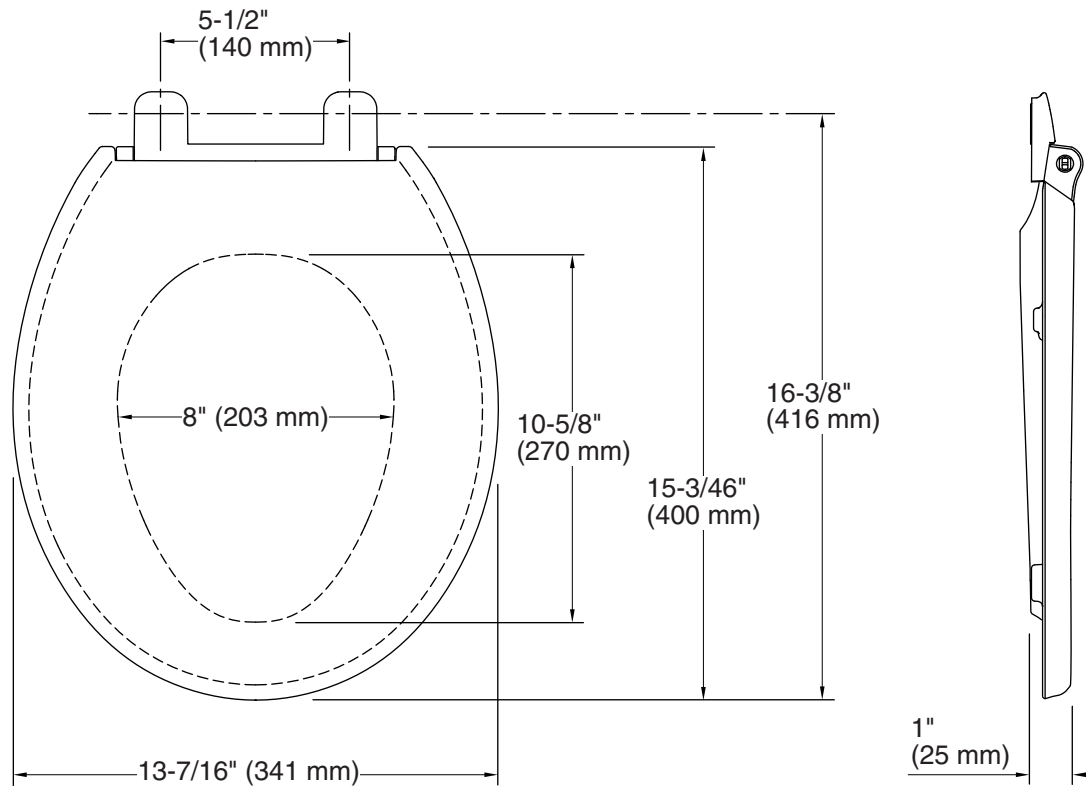

Technical Information

All product dimensions are nominal.

Seat shape type: Round-front
Seat front type: Closed-front
Seat-mounting holes: 5-1/2" (140 mm)

Notes

Install this product according to the installation guide.