

## Features

- Bask® heated surface creates spa-like relaxation with soothing warmth on your back, shoulders and neck.
- Three heat settings allow you to customize the surface temperature.
- 120 airjets release thousands of heated bubbles that surround and support the body in a warm massage.
- Purge cycles remove residual water from air channels after use to keep the system clean.
- Variable-speed blower lets you adjust massage intensity to 18 levels.
- Comfort Depth® design offers a convenient 19" step-over height while retaining the same depth as a standard 21" bath.
- Molded lumbar support offers extra comfort while bathing.
- Slotted overflow allows for deep soaking.
- Integral apron.
- Integral flange helps prevent water from seeping behind wall and simplifies alcove installation.
- Bottom surface manufactured with textured appearance.
- Right-hand drain.
- Coordinates with other products in the Archer® collection.

## Material

- Acrylic.

## Hydrotherapy

- Heated BubbleMassage™.

## Technology

- Built-in 600W BubbleMassage™ heater warms humidified air before it enters the bath.
- Bath includes auto purge (after bath drains) and manual purge cycles to remove residual water and keep system clean.
- Auto-shutoff timer on blower allows users to enjoy Heated BubbleMassage™ experience for 60 minutes before turning off.
- Built-in 60W electric heater included to keep bath surface warm.
- User interface: two separate electronic keypad controls for Heated BubbleMassage™ and Bask®.

## Installation

- Three-wall alcove.

## Required Products/Accessories

K-7271 Brass Slotted Overflow Bath Drain

or

K-7272 PVC Slotted Overflow Bath Drain

## Recommended Products/Accessories

K-1446 Remote Installation Kit

K-24916 Wireless Music Kit



## Codes/Standards

ASME A112.19.7/CSA B45.10

CSA B45.5/IAPMO Z124

ASTM E162

ASTM E662

UL 1795







CSA C22.2 No. 218.2

**KOHLER® Hydrotherapy Components  
Five-Year Limited Warranty  
KOHLER® Plastic Baths and Receptors  
Lifetime Limited Warranty**

See website for detailed warranty information.

## Available Colors/Finishes

*Color tiles intended for reference only.*

Color	Code	Description
	0	White
	96	Biscuit
	47	Almond
	NY	Dune
	95	Ice™ Grey
	58	Thunder™ Grey
	7	Black Black™

No change in measurements if connected with drain illustrated. (K-7272)

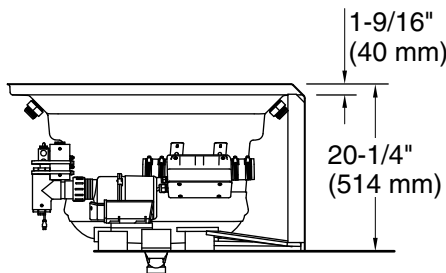
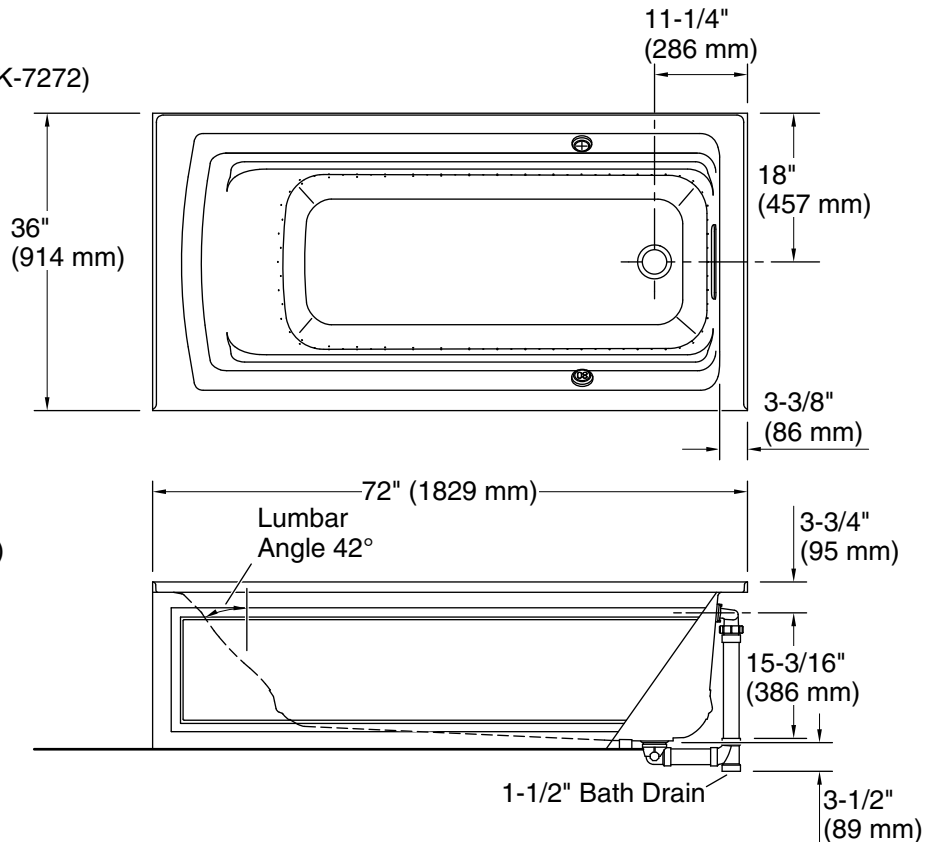
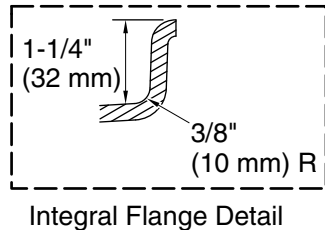

### Required Electrical Service

Two dedicated circuits required, protected with Class A Ground-Fault Circuit-Interrupter (GFCI). Outside North America, this device may be known as a Residual Current Device (RCD).

Blower, Heated	120 V, 15 A, 60 Hz
Surface:	
Heater:	120 V, 15 A, 60 Hz

### Technical Information

All product dimensions are nominal.

Installation:	Three-wall alcove
Drain location:	Right
Basin area, top:	64-1/2" x 30-1/2" (1638 mm x 775 mm)
Weight:	121 lbs (54.9 kg)
Minimum floor load:	42 lbs/ft <sup>2</sup> (205.1 kg/m <sup>2</sup> )
Water depth:	15" (381 mm)
Water capacity:	72 gal (272.5 L)
Electrical component rating:	Blower: 120 V, 10 A, 60 Hz Heated Surface: 120 V, 0.5 A, 60 Hz Heater: 120 V, 5 A, 60 Hz
Minimum flat for door:	1-9/16" (40 mm)

### Notes

Measure your actual product for rough-in details. Install this product according to the installation instructions.

The hot water supply should be 70% of the capacity of the bath or greater. Installations will vary.

Provide one grounded electrical outlet within 24" (610 mm) of each component.

Remote blower installation kit is available for relocating the blower. Provide access for servicing the blower.

Do not relocate or alter the PVC tee or coiled flexible tubing connected to the blower. Follow the blower relocation instructions exactly.