



## Handles & Inserts

Items in this section are arranged alphabetically by Manufacturer.

	page #
Cross Handles .....	223
Lever Handles.....	223
Solid Brass X-Handles.....	224
Hex Inserts.....	224
Hex Insert Set Screws.....	224
Fit-All Handle Inserts .....	221 - 222
Vise Grip.....	229 - 232
Wheel .....	229

	page #
Fit-All.....	230 - 236
Handle Buttons .....	225 - 229
Lever Handles ( <i>All Brands</i> ).....	237 - 240
Cross Handles ( <i>All Brands</i> ).....	240 - 241
Single Lever.....	241 - 252
Acrylic ( <i>Pairs</i> ).....	253 - 260
Metal ( <i>Pairs</i> ).....	261 - 277



# Broach Code Identification Guide

Our new broach coding will help you find the company specific broach to assist you in identifying the appropriate handle for your stem/ceramic or cartridge unit.

The stem shown below (23-1828) is associated with a 16pt. B-18 broach style. Therefore, the suggested handle would use that same B style broach. Since there are multiple 16pt. broaches, make sure both your stem/cartridge and corresponding handles share the same B style broach.

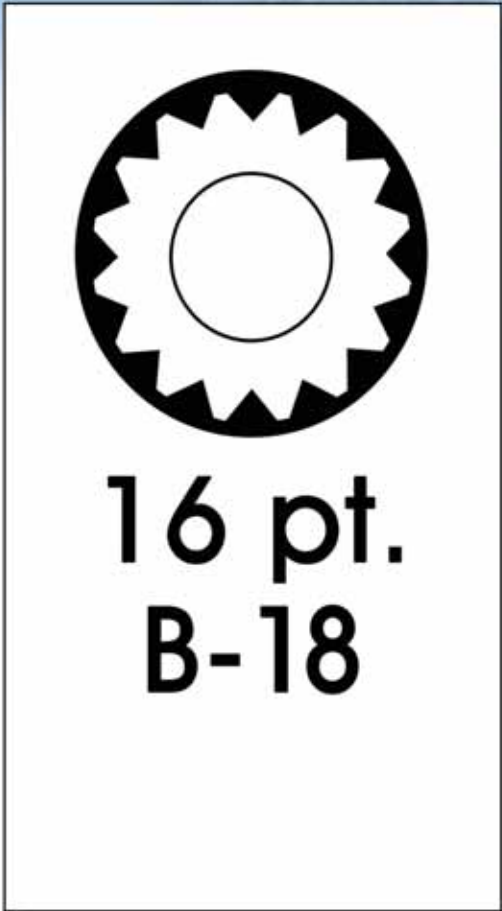



**Gerber**



**16 pt.  
B-18**

✓

**Length: 5 1/16"**

Bibb Washer: 71-0304  
Cap Gasket: 71-0019  
Suggested Handle: 99-1151  
Bibb Seat: 55-0652

Packaging	Product #	each	6 plus	50 plus	100plus
bag	23-1828 ...	\$16.20	\$13.50	\$9.15	\$8.25

**Pair of Handles (long broach)**



**Gerber**



**16 pt.  
B-18**

✓

**Index Button  
92-5009  
Handle Screw  
72-0211**

**1-3/16" x 2-1/2"**

Packaging	Product #	each	6 plus	50 plus	100plus
bag	99-1151 ...	\$14.40	\$12.00	\$9.30	\$8.40

HONEST MERCHANDISE - ETHICALLY REPRESENTED. KISSLER & CO., Inc. established 1923, makes and distributes precision replacement parts of its own manufacture or procurement. Brand names, model names or stock numbers, which may appear on Seller's invoices, catalogs, packages, quotations or correspondence, are so utilized for purposes of identification only; and are not a warranty or representation, either expressed or implied, that items offered or sold are genuine products of such original manufacturers.

**IF YOU DON'T SEE IT... ASK**







COPYRIGHT © 2017 BY KISSLER & CO., INC.



CARLSTADT, NEW JERSEY 07072

*All Brass Exact-Fit Handle Broaches • Exclusive No-Slip Design*

### 1 Series









Part #	Description
1-5	 16 point/B-16 for Sterling
1-6	 16 point/B-12 for Central, Eljer, Brngtn, Kohler (Trend), Am. Std (Cadet)
1-7	 19 point/B-33 for Kohler (Valvet)
1-8	 20 point/B-37 for American Standard 3/8"
1-12	 12 point/B-31 for Harcraft Brass
1-13	 15 point/B-14 for Savoy, Wolv. Brass

Part #	Description
1-1	 12 point/B-4 for Crane-Repcal
1-2	 12 point/B-6 for Price Pfister
1-4	 22 point/B-8 for American Standard 7/16"

### 2 Series







2-1	 22 point/B-8 for Am. Std. 7/16"
2-2	 16 point/B-12 for Youngstown
2-3	 16 point/B-18 for Gerber, Sayco
2-4	 20 point/B-20 for Speakman, T&S Brass
2-5	 12 point/B-6 for P. Pfister, Grand Haven
2-6	 16 point/B-12 for Am. Std. (Colony) Central, Eljer, Kohler (Trend)

### 3 Series



3-5	 12 point/B-6 for Michigan Brass, Wolverine (new style)
3-6	 16 point/B-16 for Sterling-Cleveland
3-7	 17 point/B-26 for Am. Brass, Streamway
3-9	 12 point/B-31 for Harcraft Brass
3-10	 12 point/B-6 for Universal Rundle
3-11	 16 point/B-16 for Mich. Brass (old style)
3-12	 B-25 for Chicago
3-17	 16 point/B-16 for Sterling-Cleveland

Part #	Description
3-1	 12 point/B-4 for Crane-Repcal
3-2	 16 point/B-18 for Gerber, Sayco
3-3	 18 point/B-22 for Briggs, Indiana, Richmond, Union Brass
3-4	 16 point/B-12 for Cntrl, Dick Brothers, Eljer, Kohler (Trend), Milwaukee

**Price** (Pricing is for 1, 2 & 3 Series Inserts; prices shown are per piece)

1-5	6-49	50-99
\$2.70	\$2.25	\$1.65

HONEST MERCHANDISE - ETHICALLY REPRESENTED. KISSLER & CO., Inc. established 1923, makes and distributes precision replacement parts of its own manufacture or procurement. Brand names, model names or stock numbers, which may appear on Seller's invoices, catalogs, packages, quotations or correspondence, are so utilized for purposes of identification only; and are not a warranty or representation, either expressed or implied, that items offered or sold are genuine products of such original manufacturers.

**IF YOU DON'T SEE IT... ASK**

All Brass Exact-Fit Handle Broaches • Exclusive No-Slip Design

**4 Series**



4-1

**Part # Description**

4-1 Fit-All (tapered, self-tapping thread)

**Price**

1-5	6-49	50-99
\$2.70	\$2.25	\$1.65



4-2



4-2 is Sold in Pairs.  
Comes complete  
with screws & wrench.

4-2 Fit-All (with four set screws & wrench sold in pairs only)

**Price**

1-5	6+
\$7.20	\$6.00

**5 Series**



5-1  22 point/B-18 for American Standard (with extension; use with elbow-action handles only)

5-2  12 point/B-6 for Crane-Repal (with ext.)

**Price**

1-5	6+
\$3.15	\$2.25

**6 Series**



6-1  10 point/B-32 for Bradley, Briggs, Cole, Kohler, Universal Rundle

6-2  B-9 for Delta-Delex

6-3  B-19 for Moen

6-4  B-5 for Delta, Peerless

6-5  20 point/B-37 for Grohe

6-6  B-9 for Universal Rundle

6-7  B-19 for Universal Rundle

6-8  B-36 for 5/16" Square

**Price**





1-5	6-49	50-99
\$2.70	\$2.25	\$1.65











These inserts (Series 4, 5 and 6) are NOT designed to be used with 98-5310 handles.

HONEST MERCHANDISE - ETHICALLY REPRESENTED. KISSLER & CO., Inc. established 1923, makes and distributes precision replacement parts of its own manufacture or procurement. Brand names, model names or stock numbers, which may appear on Seller's invoices, catalogs, packages, quotations or correspondence, are so utilized for purposes of identification only; and are not a warranty or representation, either expressed or implied, that items offered or sold are genuine products of such original manufacturers.

### 96 Series Die-cast Cross Handle







Part #	Description
<b>96-0402</b> Handle Screw 72-0111	 17 pt./B-26 for American Brass
<b>96-0403</b> Handle Screw 72-0211	 22 pt./B-8 for American Standard
<b>96-0405</b> Handle Screw 72-0311	 18 pt./B-22 for Briggs
<b>96-0406</b> Handle Screw 72-0411	 16 pt./B-12 for Central Brass
<b>96-0408</b> Handle Screw 72-0211	 16 pt./B-12 for Eljer









Part #	Description
<b>96-0410</b> Handle Screw 72-0211	 18 pt./B-22 for Indiana Brass
<b>96-0411</b> Handle Screw 72-0211	 12 pt./B-6 for Price Pfister
<b>96-0412</b> Handle Screw 72-0211	 12 pt./B-31 for Repcal (bath faucet)
<b>96-0413</b> Handle Screw 72-0211	 15 pt./B-14 for Savoy
<b>96-0416</b> Handle Screw 72-0211	 12 pt./B-31 for Sears
<b>96-0417</b> Handle Screw 72-0211	 20 pt./B-20 for Speakman
<b>96-0418</b> Handle Screw 72-0411	 16 pt./B-16 for Sterling
<b>96-0420</b> Handle Screw 72-0411	 18 pt./B-22 for Union Brass
<b>96-0421</b> Handle Screw 72-0211	 12 pt./B-31 for Universal Rundle
<b>96-0490</b> Handle Screw 72-0211	 16 pt./B-12 for Glauber

Price (sold in pairs)	
1-5	6-49
\$12.45	\$10.35

### 97 Series Die-cast Lever Handle



Part #	Description
<b>97-0402</b> Handle Screw 72-0111	 17 pt./B-26 for American Brass
<b>97-0403</b> Handle Screw 72-0211	 22 pt./B-8 for American Standard
<b>97-0405</b> Handle Screw 72-0311	 18 pt./B-22 for Briggs
<b>97-0406</b> Handle Screw 72-0411	 16 pt./B-12 for Central Brass
<b>97-0407</b> Handle Screw 72-0211	 16 pt./B-12 for Dick Brothers

Part #	Description
<b>97-0408</b> Handle Screw 72-0211	 16 pt./B-12 for Eljer
<b>97-0410</b> Handle Screw 72-0211	 18 pt./B-22 for Indiana Brass
<b>97-0411</b> Handle Screw 72-0211	 12 pt./B-6 for Price Pfister
<b>97-0412</b> Handle Screw 72-0211	 12 pt./B-3 for Repcal (comb. faucet)
<b>97-0413</b> Handle Screw 72-0211	 15 pt./B-14 for Savoy
<b>97-0417</b> Handle Screw 72-0211	 20 pt./B-20 for Speakman
<b>97-0418</b> Handle Screw 72-0411	 16 pt./B-16 for Sterling
<b>97-0419</b> Handle Screw 72-0111	 17 pt./B-26 for Streamway
<b>97-0420</b> Handle Screw 72-0411	 18 pt./B-22 for Union Brass

Price (sold in pairs)	
1-5	6-49
\$9.45	\$7.80

HONEST MERCHANDISE - ETHICALLY REPRESENTED. KISSLER & CO., Inc. established 1923, makes and distributes precision replacement parts of its own manufacture or procurement. Brand names, model names or stock numbers, which may appear on Seller's invoices, catalogs, packages, quotations or correspondence, are so utilized for purposes of identification only; and are not a warranty or representation, either expressed or implied, that items offered or sold are genuine products of such original manufacturers.

IF YOU DON'T SEE IT... ASK



**98 Series Solid Brass**



Part #	Description
<b>98-5310</b>	Solid Brass Chrome Plated (requires hex insert and set screw; see below)

Part #	Description
<b>98-5310B</b>	Solid Brass Chrome Plated, Blank surface (no H or C indicated); may be used for diverter, hot or cold. (requires hex insert and set screw; see below)

Price (sold in pairs)			
1-5	6-49	50-99	100+
\$30.00	\$24.90	\$19.80	\$18.00

Price (per single handle)			
1-5	6-49	50-99	100+
\$15.00	\$12.45	\$9.90	\$9.00

**Hex Inserts Solid Brass**

Part #	Description	Broach
<b>#FA</b>	Fit-All (self-tapping thread)	Fit-All Thread
<b>#A</b>	for 5/16" Square, Speakman	20pt.
<b>#B</b>	for 1/4" Square, 3/8" Square	square
<b>#C</b>	for 11/32" Square, Republic	8pt.
<b>#S</b>	for Scoville, Wolverine	32pt./16pt.
<b>#W</b>	for Gerber, Crane (small)	16pt./12pt.
<b>#1</b>	for 5/16" Square, Kohler	19pt.
<b>#2</b>	for Central, Lenhart Brass	16pt./17pt.
<b>#3</b>	for American Standard 3/8" & 7/16"	22pt.
<b>#4</b>	for 9/32" Square, Republic	8pt.
<b>#5</b>	for Briggs, Savoy	18pt./15pt.
<b>#6</b>	for 3/8" Square, Crane (large)	12pt.
<b>#7</b>	for Murray, Sorensen	"D" broach
<b>#8</b>	for Hudson Brass	15/32" round



Price		
1-5	6-99	100+
\$4.05	\$3.30	\$2.55

**Set Screw for handle 98-5310**

Part #	Description
<b>72-0601</b>	1/4" x 20 Stainless Set Screw (bag of 10)
<b>72-1601</b>	1/4" x 20 Stainless Set Screw (bag of 100)



72-0601	Price	72-1601
bag of 10		bag of 100
\$9.30		\$66.00

HONEST MERCHANDISE - ETHICALLY REPRESENTED. KISSLER & CO., Inc. established 1923, makes and distributes precision replacement parts of its own manufacture or procurement. Brand names, model names or stock numbers, which may appear on Seller's invoices, catalogs, packages, quotations or correspondence, are so utilized for purposes of identification only; and are not a warranty or representation, either expressed or implied, that items offered or sold are genuine products of such original manufacturers.

**Specify H or C**  
**Sayco**



**35/64" OD**

Packaging	Product #	each	6 plus
bag	92-2112....	\$1.50	\$1.20

**Specify H or C**  
**Crane-Repcal**



**9/16" OD**

Packaging	Product #	each	6 plus
bag	92-2001....	\$5.10	\$4.20

**Pair of Buttons OEM**  
**KOHLER.**



**9/16" OD**

Packaging	Product #	each
bag	92-5201P....	\$10.65

**Specify H/C/D**  
**American Standard**



**5/8" OD**

Packaging	Product #	each	6 plus
bag	92-2002....	\$9.00	\$7.50

**Specify H/C/D**  
**Briggs**



**5/8" OD**

Packaging	Product #	each	6 plus
bag	92-2113....	\$5.40	\$4.50

**Specify H/C/D**  
**American Standard**



**21/32" OD**

Packaging	Product #	each	6 plus	50 plus
bag	92-2003....	\$0.90	\$0.75	\$0.60
clam	792-2003S....	\$5.40		

**Specify H/C Color Coded**  
**American Standard**



**21/32" OD**

Packaging	Product #	each	6 plus	50 plus
bag	92-2114....	\$9.00	\$7.50	\$5.25

**Specify H or C**  
**Delta**



**23/32" OD**

Packaging	Product #	each	6 plus	50 plus
bag	92-5223....	\$1.50	\$1.20	\$0.75

**Specify H/C/D**  
**American Standard**



**13/16" OD**

Packaging	Product #	each	6 plus	50 plus
bag	92-2004....	\$1.50	\$1.20	\$0.75

**Specify H or C**  
**Gerber**



**7/8" OD**

Packaging	Product #	each	6 plus
bag	92-5211....	\$0.90	\$0.75

**Specify H/C/D**  
**Kohler**



**13/16" OD**

Packaging	Product #	each	6 plus	50 plus
bag	92-5226....	\$2.10	\$1.65	\$1.35

**Specify H or C**  
**Streamway**



**25/32" OD**

Packaging	Product #	each	6 plus
bag	92-5224....	\$1.50	\$1.20

HONEST MERCHANDISE-ETHICALLY REPRESENTED: KISSLER & CO. INC. established 1923 makes and distributes precision replacement parts of it's own manufacture and procurement. Brand names, model names, original manufacturers' name or stock numbers, which may appear on Seller's invoices, catalogs, packages, quotations or correspondence, are so utilized for identification purposes only; and are not a warranty or representation, either expressed or implied, that items offered or sold are genuine products of such original manufacturers

**Pair of Buttons**  
American Standard



**7/8" OD**

Packaging	Product #	each	6 plus
bag	92-5228P ....	\$5.10	\$4.20

**Specify H/C OEM**



**7/8" OD**

Packaging	Product #	each
bag	92-2118 ....	\$4.50

**Specify H/C/D**  
Price Pfister



**15/16" OD**

Packaging	Product #	each	6 plus	50 plus	100 plus
bag	92-5008 ....	\$0.90	\$0.75	\$0.45	\$0.36
clam	792-5008S ....	\$4.20			

**Specify H or C**  
Valley



**1" OD**

Packaging	Product #	each	6 plus
bag	92-5231 ....	\$1.50	\$1.20



**Specify H/C/D**  
Price Pfister



**1" OD**

Packaging	Product #	each	6 plus
bag	92-1186 ....	\$0.90	\$0.75

**Specify H/C OEM**

**1-1/32" OD**

Packaging	Product #	each
bag	92-5235 ....	\$2.55

**Specify H/C/D**  
Gerber



**1-1/16" OD**

Packaging	Product #	each	6 plus	100 plus
bag	92-5009 ....	\$0.90	\$0.75	\$0.42
clam	792-5009S ....	\$4.20	\$3.45	

**Cold Index Button (10/bag)**  
GERBER.



**OEM**

Packaging	Product #	each
bag	KGR94-446 ....	\$12.45

**Hot Index Button (10/bag)**  
GERBER.



**OEM**

Packaging	Product #	each
bag	KGR94-445 ....	\$12.45

**Diverter Index Button (10/bag)**  
GERBER.



**OEM**

Packaging	Product #	each
bag	KGR94-447 ....	\$12.45

**Specify H/C/D**  
Price Pfister



**1-1/16" OD**

Packaging	Product #	each	6 plus	50 plus
bag	92-2127 ....	\$1.80	\$1.50	\$0.90

**Specify H/C/D**  
Gerber



**1-1/4" OD**

Packaging	Product #	each	6 plus
bag	92-5216 ....	\$0.90	\$0.75

HONEST MERCHANDISE-ETHICALLY REPRESENTED: KISSLER & CO. INC. established 1923 makes and distributes precision replacement parts of it's own manufacture and procurement. Brand names, model names, original manufacturers' name or stock numbers, which may appear on Seller's invoices, catalogs, packages, quotations or correspondence, are so utilized for identification purposes only: and are not a warranty or representation, either expressed or implied, that items offered or sold are genuine products of such original manufacturers



**Specify H/C/D**  
**Price Pfister**



**1-1/8" OD**

Packaging	Product #	each	6 plus	50 plus
bag	92-2129 ....	\$3.60	\$3.00	\$1.80

**Specify H or C**  
**Sterling**



**1-1/8" OD**

Packaging	Product #	each	6 plus
bag	92-5245 ....	\$2.10	\$1.65

**package of 3 OEM**  
**KOHLER**



**1-3/16" OD**

Packaging	Product #	each
bag	92-5214S ....	\$31.95

**Pair of Buttons**  
**Moen**



**1-1/4" OD**

Packaging	Product #	each	6 plus
bag	92-5243P ....	\$6.00	\$4.95

**Specify H or C**  
**Nibco**



**1-1/4" OD**

Packaging	Product #	each	6 plus
bag	92-5280 ....	\$1.35	\$1.05

**Specify H/C/D**  
**Sayco**



**1-9/32" OD**

Packaging	Product #	each	6 plus	50 plus	100 plus
bag	92-5246 ....	\$1.35	\$1.05	\$0.75	\$0.60

**Specify H/C/D**  
**Sterling**



**1-1/4" OD**

Packaging	Product #	each	6 plus
bag	92-5242 ....	\$1.65	\$1.35

**Pair of Buttons**  
**Delta**



**1-5/16" OD**

Packaging	Product #	each	6 plus	50 plus	100 plus
bag	92-5247P ....	\$3.30	\$2.70	\$2.10	\$1.80
clam	792-5247P ....	\$6.30			

**Specify H/C/D**  
**American Standard**



**1-3/8" OD**

Packaging	Product #	each	6 plus
bag	92-5113 ....	\$3.00	\$2.40

**Single Lever**  
**Price Pfister**



**1-3/8" OD**

Packaging	Product #	each	6 plus
bag	92-5265 ....	\$2.25	\$1.80

**Specify H or C**  
**American Standard**



**1-9/16" OD**

Packaging	Product #	each	6 plus
bag	92-5114 ....	\$3.00	\$2.40

**Specify H or C**  
**American Standard**



**1-5/8" OD**

Packaging	Product #	each	6 plus
bag	92-2146 ....	\$5.40	\$4.50

HONEST MERCHANDISE-ETHICALLY REPRESENTED: KISSLER & CO. INC. established 1923 makes and distributes precision replacement parts of it's own manufacture and procurement. Brand names, model names, original manufacturers' name or stock numbers, which may appear on Seller's invoices, catalogs, packages, quotations or correspondence, are so utilized for identification purposes only: and are not a warranty or representation, either expressed or implied, that items offered or sold are genuine products of such original manufacturers

*Specify H or C*

**Harcraft**



**1-11/16" OD**

Packaging	Product #	each	6 plus
bag	92-2160....	\$3.60	\$3.00

*Specify H/C/D*

**Harcraft**



**2" OD**

Packaging	Product #	each	6 plus
bag	92-2161....	\$3.60	\$3.00

*Single Lever*

**Valley**



**1" OD**

Packaging	Product #	each	6 plus	50 plus
bag	92-5210....	\$1.50	\$1.20	\$0.90

*Single Lever OEM*

**Bradley**



**1-1/16" OD**

Packaging	Product #	each
bag	92-2128....	\$8.70

*Single Lever OEM*

**KOHLER**



**1-3/16" OD**

Packaging	Product #	each
bag	92-5212....	\$17.10

*Single Lever OEM*

**KOHLER**



**1-3/16" OD**

Packaging	Product #	each
bag	92-5213....	\$7.20

*Single Lever*

**Kohler**



**1-7/32" OD**

Packaging	Product #	each	6 plus
bag	92-5240....	\$2.25	\$1.80

*Single Lever*

**Imported**



**1 1/4" OD**

Packaging	Product #	each	6 plus
bag	92-9389....	\$1.50	\$1.20

*Single Lever OEM*

**DELTA**



**1-5/16" OD**

Packaging	Product #	each
bag	92-5248....	\$13.50

*Single Lever*

**Kohler**



**1-3/8" OD**

Packaging	Product #	each	6 plus
bag	92-5111....	\$2.55	\$2.10

*Single Lever OEM*

**American Standard**



**1-15/32" OD**

Packaging	Product #	each
bag	92-5268....	\$13.05

*Single Lever*

**Briggs**



**1-9/16" OD**

Packaging	Product #	each	6 plus	50 plus
bag	92-5270....	\$4.35	\$3.60	

HONEST MERCHANDISE-ETHICALLY REPRESENTED: KISSLER & CO. INC. established 1923 makes and distributes precision replacement parts of it's own manufacture and procurement. Brand names, model names, original manufacturers' name or stock numbers, which may appear on Seller's invoices, catalogs, packages, quotations or correspondence, are so utilized for identification purposes only; and are not a warranty or representation, either expressed or implied, that items offered or sold are genuine products of such original manufacturers

**Single Lever**  
**Nibco**



**1-9/16" OD**

Packaging	Product #	each	6 plus
bag	92-5254....	\$4.80	\$3.90

**Single Lever**  
**Moen**



**1-5/8" OD**

Packaging	Product #	each	6 plus
bag	92-5253....	\$3.15	\$2.55

**Single Lever**  
**Moen**



**1-5/8" OD**

Packaging	Product #	each	6 plus
bag	92-5272....	\$3.00	\$2.40

**Single Lever OEM**  
**MOEN**



**1-5/8" OD**

Packaging	Product #	each
bag	92-5279....	\$15.60

**Single Lever**  
**Price Pfister**



**1-5/8" OD**

Packaging	Product #	each	6 plus
bag	92-9255....	\$3.15	\$2.55

**Single Lever**  
**Price Pfister**



**1-9/16" OD**

Packaging	Product #	each	6 plus
bag	92-5255....	\$3.15	\$2.55

**Single Lever**  
**American Standard**



**1-7/8" OD**

Packaging	Product #	each	6 plus
bag	92-5260....	\$5.10	\$4.20

**Wheel Handle**



**12 pt. B-24**

Packaging	Product #	each	6 plus
bag	08-0701....	\$3.15	\$2.55

**Wheel Handle**



**B-25**

Packaging	Product #	each	6 plus	50 plus
bag	08-0700....	\$3.15	\$2.55	\$1.95

**Wheel Handle Heavy**



**B-25**

Packaging	Product #	each	6 plus
bag	08-0702....	\$2.10	\$1.65

**Stop Valve Handle**



Packaging	Product #	each
bag	58-2003....	\$4.05

**Pair of Handles**  
**Fits-All**



**B-27**

vise grip broach **1-7/8" x 1"**

Packaging	Product #	each	6 plus
bag	97-9999....	\$13.50	\$11.25
clam	797-9999....	\$15.00	\$12.75

HONEST MERCHANDISE-ETHICALLY REPRESENTED: KISSLER & CO. INC. established 1923 makes and distributes precision replacement parts of it's own manufacture and procurement. Brand names, model names, original manufacturers' name or stock numbers, which may appear on Seller's invoices, catalogs, packages, quotations or correspondence, are so utilized for identification purposes only; and are not a warranty or representation, either expressed or implied, that items offered or sold are genuine products of such original manufacturers

**Pair of Handles**  
Fits-All



2-5/16" x 13/16"

Packaging	Product #	each	6 plus
bag	97-0144 ....	\$13.50	\$11.25
clam	797-0144 ....	\$15.00	

**Pair of Handles**  
Fits-All



requires insert  
2-5/16" x 3/4"

Packaging	Product #	each	6 plus
bag	97-0000 ....	\$12.00	\$9.90
clam	797-0000 ....	\$13.50	\$11.40

**Pair of Handles CP**  
Fits-All

chrome plated dome/ chrome  
2-3/4" x 2"

Packaging	Product #	each	6 plus
bag	97-1100 ....	\$36.00	\$30.00

**Pair of Handles Brushed Nickel**  
Fits-All



brushed nickel dome/ nickel  
finish

Packaging	Product #	each
clam	797-1100BN ....	\$43.20

**Pair of Handles CP**  
Fits-All



chrome plated dome/clear  
handle...requires insert  
2-5/16" x 2"

Packaging	Product #	each
bag	97-1200 ....	\$36.00

**Pair of Handles CP**  
Fits-All



chrome plated dome/wood  
handle...requires insert  
2-5/8" x 2"

Packaging	Product #	each
bag	97-1300 ....	\$36.00

**Pair of Handles CP**  
Fits-All



2-15/16" x 2"

Packaging	Product #	each
bag	97-1400 ....	\$36.00

**Pair of Handles PB**  
Fits-All



polished brass dome/ chrome  
handle...requires insert  
2-1/4" x 2"

Packaging	Product #	each
bag	97-2100 ....	\$36.00

**Pair of Handles PB**  
Fits-All



polished brass dome/clear  
handle...requires insert  
2-5/16" x 2"

Packaging	Product #	each
bag	97-2200 ....	\$36.00

**Pair of Handles PB**  
Fits-All



polished brass dome/wood  
handle...requires insert  
2-5/8" x 2"

Packaging	Product #	each
bag	97-2300 ....	\$36.00

**Pair of Handles PB**  
Fits-All



2-5/8" x 2"

Packaging	Product #	each
bag	97-2400 ....	\$36.00

**Paif of Handles with Porcelaike**  
Fits-All



2-1/2" x 2-5/8"

Packaging	Product #	each	6 plus
bag	97-3243 ....	\$30.60	\$25.50
clam	797-3243 ....	\$33.60	

HONEST MERCHANDISE-ETHICALLY REPRESENTED: KISSLER & CO. INC. established 1923 makes and distributes precision replacement parts of it's own manufacture and procurement. Brand names, model names, original manufacturers' name or stock numbers, which may appear on Seller's invoices, catalogs, packages, quotations or correspondence, are so utilized for identification purposes only: and are not a warranty or representation, either expressed or implied, that items offered or sold are genuine products of such original manufacturers

### Pair of Handles with Acrylic Lever

Fits-All



2-3/8" x 2-5/8"

Packaging	Product #	each	6 plus
bag	97-3443 ....	\$30.60	\$25.50
clam	797-3443 ....	\$33.60	

### Pair of Handles

Fits-All



Index Button  
92-2003

requires insert

4-1/2" x 1"

Packaging	Product #	each	6 plus	50 plus
bag	98-0400 ....	\$35.40	\$29.40	\$23.10

### Pair of Handles

Fits-All



3-1/2" x 2-3/8"

Packaging	Product #	each	6 plus
bag	97-2044 ....	\$43.20	\$36.00
clam	797-2044 ....	\$45.00	

### Pair of Handles

Fits-All



3-7/8" x 1-5/16"

Packaging	Product #	each	6 plus
bag	97-3044 ....	\$32.40	\$27.00
clam	797-3044 ....	\$34.20	

### (1) Handle

Fits-All



chrome base porcelain style  
handle

2-15/16" x 2-5/16"

Packaging	Product #	each
clam	97-9045 ....	\$28.80 \$24.00

### (1) Handle PB

Fits-All



polished brass base porcelain  
style handle

2-15/16" x 2-5/16"

Packaging	Product #	each
clam	97-9046 ....	\$36.00 \$30.00

### Pair of Handles

Fits-All



chrome base porcelain style  
handle...requires insert

3-1/4" x 1-3/4"

Packaging	Product #	each
bag	97-1000 ....	\$54.00
clam	797-1000 ....	\$55.50

### Pair of Handles

Fits-All



1-5/16" x 1/2"

Packaging	Product #	each	6 plus
bag	96-3000 ....	\$27.00	\$22.50
clam	796-3000 ....	\$30.00	

### Pair of Handles

Fits-All



B-27

vise grip broach

1-5/16" x 1"

Packaging	Product #	each	6 plus	50 plus
bag	96-9999 ....	\$14.40	\$12.00	\$9.00
clam	796-9999 ....	\$17.40	\$15.00	

### Pair of Handles

Fits-All



Index Button  
92-2003

requires insert

1-7/16" x 1"

Packaging	Product #	each	6 plus	50 plus
bag	96-0000 ....	\$13.20	\$10.80	\$8.40
clam	796-0000 ....	\$14.70	\$12.30	

### Pair of Handles

with Fit All inserts



Index Button  
92-2003

1-7/16" x 1"

Packaging	Product #	each	6 plus
bag	96-0042 ....	\$20.40	\$16.80
clam	796-0042 ....	\$21.60	\$18.30

### Diverter

Fits-All



Index Button  
92-2003D

requires insert

1-7/16" x 1"

Packaging	Product #	each	6 plus
bag	96-0000D ....	\$6.60	\$5.40

HONEST MERCHANDISE-ETHICALLY REPRESENTED: KISSLER & CO. INC. established 1923 makes and distributes precision replacement parts of it's own manufacture and procurement. Brand names, model names, original manufacturers' name or stock numbers, which may appear on Seller's invoices, catalogs, packages, quotations or correspondence, are so utilized for identification purposes only; and are not a warranty or representation, either expressed or implied, that items offered or sold are genuine products of such original manufacturers



**Pair of Handles**  
Fits-All



chrome base porcelain style handle...requires insert **1-3/8" x 3-1/16"**

Packaging	Product #	each	6 plus
bag	96-2000 ....	\$30.60	\$25.50
clam	796-2043 ....	\$32.40	

**(1) Handle**  
Fits-All



chrome base porcelain style handle **1-5/8" x 2-1/2"**

Packaging	Product #	each	6 plus
clam	96-9055 ....	\$39.60	\$33.00

**(1) Handle PB**  
Fits-All



polished brass base porcelain style handle **1-5/8" x 2-1/2"**

Packaging	Product #	each	6 plus
clam	96-9056 ....	\$39.60	\$33.00



**(1) Handle**  
Fits-All



all chrome base and handle **1-5/8" x 2-1/2"**

Packaging	Product #	each	6 plus
clam	96-9065 ....	\$43.20	\$36.00

**Pair of Handles**  
Fits-All

vise grip broach **1-1/4" x 2-1/16"**

Packaging	Product #	each	6 plus
bag	95-9999 ....	\$18.00	\$15.00
clam	795-9999 ....	\$19.50	\$16.50

**Pair of Handles**  
Fits-All



**1-5/16" x 1-11/16"**

Packaging	Product #	each	6 plus
bag	93-1043 ....	\$12.60	\$10.50
clam	793-1043 ....	\$14.40	\$12.00

**Pair of Handles**  
Fits-All



**1-1/8" x 2-1/16"**

Packaging	Product #	each	6 plus
bag	95-7823 ....	\$14.40	\$12.00
clam	795-7823 ....	\$16.20	\$13.50

**Pair of Handles**  
Fits-All



**1-3/8" x 2-5/8"**

Packaging	Product #	each	6 plus
bag	95-7833 ....	\$18.00	\$15.00
clam	795-7833 ....	\$19.80	\$16.50

**Diverter**  
Fits-All



**1-3/8" x 2-5/8"**

Packaging	Product #	each	6 plus
bag	95-7833D ....	\$12.60	\$10.50
clam	795-7833D ....	\$14.40	

**Pair of Handles**  
Fits-All



**1-3/8" x 2-5/8"**

Packaging	Product #	each	6 plus
bag	95-7835 ....	\$18.00	\$15.00
clam	795-7835 ....	\$19.80	\$16.50

**Diverter**  
Fits-All



**1-3/8" x 2-5/8"**

Packaging	Product #	each	6 plus
bag	95-7835D ....	\$12.60	\$10.50
clam	795-7835D ....	\$14.40	

**Pair of Handles**  
Fits-All



requires insert **1-13/16" x 1-1/4"**

Packaging	Product #	each	6 plus
bag	98-0100 ....	\$12.30	\$10.20
clam	798-0100 ....	\$13.80	\$11.70

HONEST MERCHANDISE-ETHICALLY REPRESENTED: KISSLER & CO. INC. established 1923 makes and distributes precision replacement parts of it's own manufacture and procurement. Brand names, model names, original manufacturers' name or stock numbers, which may appear on Seller's invoices, catalogs, packages, quotations or correspondence, are so utilized for identification purposes only: and are not a warranty or representation, either expressed or implied, that items offered or sold are genuine products of such original manufacturers

**Pair of Handles**  
with Fit All inserts



**1-13/16" x 1-1/4"**

Packaging	Product #	each	6 plus
bag	98-0142 ....	\$19.50	
clam	798-0142 ....	\$21.00	

**Pair of Handles**  
Fits-All



**1-13/16" x 1-1/4"**

Packaging	Product #	each	6 plus
bag	98-0143 ....	\$16.20	\$13.50
clam	798-0143 ....	\$18.00	

**Pair of Handles**  
Fits-All



requires insert **1-13/16" x 1-1/4"**

Packaging	Product #	each	6 plus
bag	98-0200 ....	\$12.30	\$10.20
clam	798-0200 ....	\$13.80	\$11.70

**Pair of Handles**  
with Fit All inserts



**1-13/16" x 1-1/4"**

Packaging	Product #	each	6 plus
clam	798-0242 ....	\$21.00	\$17.70

**Pair of Handles**  
Fits-All



**1-13/16" x 1-1/4"**

Packaging	Product #	each	6 plus
bag	98-0243 ....	\$16.20	\$13.50
clam	798-0243 ....	\$18.00	

**Diverter**  
Fits-All



**1-13/16" x 1-1/4"**

Packaging	Product #	each	6 plus
bag	98-0243D ....	\$10.80	\$9.00
clam	798-0243D ....	\$13.80	

**Pair of Handles**  
Fits-All



requires insert **1" x 1"**

Packaging	Product #	each	6 plus
bag	98-0300 ....	\$12.30	\$10.20
clam	798-0300 ....	\$13.80	\$11.70

**Pair of Handles**  
with Fit All inserts



**1" x 1"**

Packaging	Product #	each	6 plus
clam	798-0342 ....	\$21.00	\$17.70

**Pair of Handles**  
Fits-All



**1" x 1"**

Packaging	Product #	each	6 plus
bag	98-0343 ....	\$16.20	\$13.50
clam	798-0343 ....	\$19.20	

**Diverter**  
Fits-All



requires insert **1" x 1"**

Packaging	Product #	each	6 plus
bag	98-0300D ....	\$6.15	\$5.10

**Pair of Handles**  
Fits-All



requires insert **1" x 1-1/4"**

Packaging	Product #	each	6 plus
bag	98-0500 ....	\$12.30	\$10.20
clam	798-0500 ....	\$13.80	\$11.70

**Pair of Handles**  
with Fit All inserts



**1" x 1-1/4"**

Packaging	Product #	each	6 plus
clam	798-0542 ....	\$21.00	\$17.70

HONEST MERCHANDISE-ETHICALLY REPRESENTED: KISSLER & CO. INC. established 1923 makes and distributes precision replacement parts of it's own manufacture and procurement. Brand names, model names, original manufacturers' name or stock numbers, which may appear on Seller's invoices, catalogs, packages, quotations or correspondence, are so utilized for identification purposes only; and are not a warranty or representation, either expressed or implied, that items offered or sold are genuine products of such original manufacturers

**Pair of Handles**  
**Fits-All**



**1" x 1-1/4"**

Packaging	Product #	each	6 plus
bag	98-0543....	\$16.20	\$13.50
clam	798-0543....	\$18.00	

**Diverter**  
**Fits-All**



requires insert  
**1" x 1-1/4"**

Packaging	Product #	each	6 plus
bag	98-0500D....	\$6.15	\$5.10

**Pair of Handles**  
**Fits-All**



requires insert  
**1" x 1-9/16"**

Packaging	Product #	each	6 plus
bag	98-0600....	\$12.30	\$10.20
clam	798-0600....	\$13.80	\$11.70

**Pair of Handles**  
**with Fit All inserts**



**1" x 1-9/16"**

Packaging	Product #	each
clam	798-0642....	\$21.00 \$17.70

**Pair of Handles**  
**Fits-All**



**1" x 1-9/16"**

Packaging	Product #	each	6 plus
bag	98-0643....	\$16.20	\$13.50
clam	798-0643....	\$18.00	

**Diverter**  
**Fits-All**



requires insert  
**1" x 1-9/16"**

Packaging	Product #	each	6 plus
bag	98-0600D....	\$6.15	\$5.10
clam	798-0642D....	\$15.00	

**Pair of Handles**  
**Fits-All**



requires insert  
**1" x 1-3/4"**

Packaging	Product #	each	6 plus
bag	98-0700....	\$12.30	\$10.20
clam	798-0700....	\$13.80	\$11.70

**Diverter**  
**Fits-All**



requires insert  
**1" x 1-3/4"**

Packaging	Product #	each	6 plus
bag	98-0700D....	\$6.15	\$5.10
clam	798-0742D....	\$15.00	

**Pair of Handles**  
**with Fit All inserts**



**1" x 1-3/4"**

Packaging	Product #	each
clam	798-0742....	\$21.00 \$17.70

**Pair of Handles**  
**Fits-All**



**1" x 1-13/16"**

Packaging	Product #	each	6 plus
bag	98-0743....	\$16.20	\$13.50
clam	798-0743....	\$18.00	

**Pair of Handles**  
**Fits-All**



**1-5/16" x 1-9/16"**

Packaging	Product #	each	6 plus
bag	98-1244....	\$14.40	\$12.00
clam	798-1244....	\$16.20	

**Pair of Handles**  
**Fits-All**



**7/8" x 2-1/8"**

Packaging	Product #	each	6 plus
bag	98-1543....	\$18.00	\$15.00
clam	798-1543....	\$21.00	

HONEST MERCHANDISE-ETHICALLY REPRESENTED: KISSLER & CO. INC. established 1923 makes and distributes precision replacement parts of it's own manufacture and procurement. Brand names, model names, original manufacturers' name or stock numbers, which may appear on Seller's invoices, catalogs, packages, quotations or correspondence, are so utilized for identification purposes only; and are not a warranty or representation, either expressed or implied, that items offered or sold are genuine products of such original manufacturers

**Pair of Handles**  
Fits-All



7/8" x 1-5/8"

Packaging	Product #	each	6 plus
bag	98-1643 ....	\$10.80	\$9.00
clam	798-1643 ....	\$12.60	

**Pair of Handles**  
Fits-All



1-1/4" x 2-1/2"

Packaging	Product #	each	6 plus
bag	98-2444 ....	\$18.00	\$15.00
clam	798-2444 ....	\$19.80	\$16.50

**Diverter**  
Fits-All



1-1/4" x 2-1/2"

Packaging	Product #	each	6 plus
bag	98-2444D ....	\$10.80	\$9.00
clam	798-2444D ....	\$12.60	

**Pair of Handles**  
Fits-All



1-1/4" x 2-11/16"

Packaging	Product #	each	6 plus
bag	98-2543 ....	\$21.60	\$18.00
clam	798-2543 ....	\$24.60	

**Diverter**  
Fits-All



1-1/4" x 2-11/16"

Packaging	Product #	each	6 plus
bag	98-2543D ....	\$14.40	\$12.00
clam	798-2543D ....	\$17.40	

**Pair of Handles**  
Fits-All



1-1/4" x 2-3/8"

Packaging	Product #	each	6 plus
bag	98-2643 ....	\$18.00	\$15.00
clam	798-2643 ....	\$19.80	

**Diverter**  
Fits-All



1-1/4" x 2-3/8"

Packaging	Product #	each	6 plus
bag	98-2643D ....	\$10.80	\$9.00
clam	798-2643D ....	\$12.60	

**Pair of Handles**  
Fits-All



1-1/4" x 2-9/16"

Packaging	Product #	each	6 plus
bag	98-3543 ....	\$18.00	\$15.00
clam	798-3543 ....	\$19.80	\$16.50

**Diverter**  
Fits-All



1-1/4" x 2-9/16"

Packaging	Product #	each	6 plus
bag	98-3543D ....	\$10.80	\$9.00
clam	798-3543D ....	\$12.60	

**Brushed Nickel**  
Fits-All



1" x 1-1/4"

Packaging	Product #	each
clam	799-9000BN ....	\$18.00 \$15.00

**Pair of Handles**  
Fits-All



Index Button  
92-2004

requires insert

15/16" x 1-1/2"

Packaging	Product #	each	6 plus
bag	93-0800 ....	\$19.50	\$16.20
clam	793-0842 ....	\$27.45	

**Pair of Handles**  
Fits-All



Index Button  
92-2004

requires insert

1-1/8" x 1-11/16"

Packaging	Product #	each	6 plus
bag	94-0800 ....	\$28.80	\$24.00
clam	794-0842 ....	\$37.50	

HONEST MERCHANDISE-ETHICALLY REPRESENTED: KISSLER & CO. INC. established 1923 makes and distributes precision replacement parts of it's own manufacture and procurement. Brand names, model names, original manufacturers' name or stock numbers, which may appear on Seller's invoices, catalogs, packages, quotations or correspondence, are so utilized for identification purposes only; and are not a warranty or representation, either expressed or implied, that items offered or sold are genuine products of such original manufacturers



**Diverter**  
**Fits-All**



**Index Button**  
92-2004D

requires insert **1-1/8" x 1-11/16"**

Packaging	Product #	each	6 plus
bag	94-0800D....	\$14.40	\$12.00

**Pair of Handles**  
**Fits-All**



**Index Button**  
92-5010

requires insert **1-1/4" x 1-15/16"**

Packaging	Product #	each	6 plus
bag	93-0100....	\$10.50	\$8.70
clam	793-0100....	\$12.00	\$10.20

**Pair of Handles**  
**with Fit All inserts**



**Index Button**  
92-5010

requires insert **1-1/4" x 1-15/16"**

Packaging	Product #	each	6 plus
bag	93-0142....	\$17.70	
clam	793-0142....	\$19.20	\$16.20

**(Smoke) Pair of Handles**  
**Fits-All**



**Index Button**  
92-5010

requires insert **1-1/4" x 1-15/16"**

Packaging	Product #	each
bag	93-0200....	\$11.70
clam	793-0242....	\$20.40

**Diverter**  
**Fits-All**



**Index Button**  
92-5010D

requires insert **1-1/4" x 1-15/16"**

Packaging	Product #	each	6 plus
bag	93-0400....	\$5.25	\$4.35
clam	793-0442....	\$13.95	

**Diverter (Smoke)**  
**Fits-All**



**Index Button**  
92-5010D

requires insert **1-1/4" x 1-15/16"**

Packaging	Product #	each
bag	93-0500....	\$5.85

**Pair of Handles**  
**Fits-All**



**Index Button**  
92-5010

requires insert **1-3/8" x 2-3/4"**

Packaging	Product #	each	6 plus
bag	94-0100....	\$12.60	\$10.50
clam	794-0100....	\$14.10	\$12.00

**Pair of Handles**  
**with Fit All inserts**



**Index Button**  
92-5010

requires insert **1-3/8" x 2-3/4"**

Packaging	Product #	each
bag	94-0142....	\$19.80
clam	794-0142....	\$21.30

**Pair of Handles (Smoke)**  
**Fits-All**



**Index Button**  
92-5010

requires insert **1-3/8" x 2-3/4"**

Packaging	Product #	each	6 plus
bag	94-0200....	\$14.40	\$12.00
clam	794-0242....	\$23.10	

**Pair of Handles (Amber)**  
**Fits-All**



**Index Button**  
92-5010

requires insert **1-3/8" x 2-3/4"**

Packaging	Product #	each
bag	94-0300....	\$14.40

**Diverter**  
**Fits-All**



**Index Button**  
92-5010D

requires insert **1-3/8" x 2-3/4"**

Packaging	Product #	each	6 plus
bag	94-0400....	\$6.30	\$5.25
clam	794-0442....	\$15.00	

**Diverter (Smoke)**  
**Fits-All**



**Index Button**  
92-5010D

requires insert **1-3/8" x 2-3/4"**

Packaging	Product #	each
bag	94-0500....	\$7.20
clam	794-0542....	\$15.90

HONEST MERCHANDISE-ETHICALLY REPRESENTED: KISSLER & CO. INC. established 1923 makes and distributes precision replacement parts of it's own manufacture and procurement. Brand names, model names, original manufacturers' name or stock numbers, which may appear on Seller's invoices, catalogs, packages, quotations or correspondence, are so utilized for identification purposes only: and are not a warranty or representation, either expressed or implied, that items offered or sold are genuine products of such original manufacturers



**Diverter (Amber)**

**Fits-All**



**Index Button**  
92-5010D

requires insert      **1-3/8" x 2-3/4"**

Packaging	Product #	each
bag	94-0600....	\$7.20

**Brushed Nickel**

**Fits-All**



**(clam pack only)**

Packaging	Product #	each
clam	795-9000BN....	\$18.00 \$15.00

**Pair of Handles**

**American Kitchen**



**16 pt. B-12**  
**Index Button**

**Handle Screw**  
72-0121

**2-1/8" x 1-1/16"**

Packaging	Product #	each	6 plus
bag	97-0113....	\$12.60	\$10.50

**Pair of Handles**

**American Standard**



**12 pt. B-6**  
**Index Button**

**Handle Screw**  
72-0211

**2" x 1/2"**

Packaging	Product #	each
bag	97-0321....	\$18.00

**Pair of Handles**

**American Standard**



**22 pt. B-8**  
**Index Button**

**Handle Screw**  
72-0215

**2" x 5/8"**

Packaging	Product #	each	6 plus
bag	97-0108....	\$10.80	\$9.00

**Pair of Handles**

**American Standard**



**22 pt. B-8**  
**Index Button**

**Handle Screw**  
72-0213

**2" x 9/16"**

Packaging	Product #	each	6 plus
bag	97-0109....	\$10.80	\$9.00

**Pair of Handles**

**American Standard**



**22 pt. B-8**  
**Index Button**  
92-2114

**Handle Screw**  
72-0216

**4-1/4" x 1-1/16"**

Packaging	Product #	each	6 plus
bag	97-4101....	\$34.20	\$28.50

**Pair of Handles**

**American Standard**



**22 pt. B-8**  
**Index Button**  
92-2114

**Handle Screw**  
72-0216

**5-3/4" x 1"**

Packaging	Product #	each	6 plus
bag	97-6101....	\$39.60	\$33.00

**Pair of Handles (lavatory)**

**American Standard**



**Large broach**

Packaging	Product #	each	6 plus
bag	97-4120....	\$50.40	\$42.00

**Pair of Handles (shower)**

**American Standard**



**Large Broach**

Packaging	Product #	each	6 plus
bag	97-4220....	\$57.60	\$48.00

**Diverter**

**Briggs**



**8 pt. B-48**

**Handle Screw**  
72-0212

**2-1/8" x 3/8"**

Packaging	Product #	each
bag	97-0301....	\$10.80

**Pair of Handles**

**Central Brass**



**16 pt. B-12**



**Handle Screw**  
72-0411

**4" x 11/16"**

Packaging	Product #	each
bag	97-6130....	\$45.00

HONEST MERCHANDISE-ETHICALLY REPRESENTED: KISSLER & CO. INC. established 1923 makes and distributes precision replacement parts of it's own manufacture and procurement. Brand names, model names, original manufacturers' name or stock numbers, which may appear on Seller's invoices, catalogs, packages, quotations or correspondence, are so utilized for identification purposes only: and are not a warranty or representation, either expressed or implied, that items offered or sold are genuine products of such original manufacturers

**Pair of Handles**  
Chicago

**B-25**  
Index Button  
92-2001  
Handle Screw  
72-0411  
2-3/8" x 11/16"

Packaging	Product #	each	6 plus
bag	97-0124....	\$31.50	\$26.25



**Pair of Handles**  
Chicago



**B-25**  
Index Button  
92-2001  
Handle Screw  
72-0412  
4" x 11/16"

Packaging	Product #	each	6 plus
bag	97-4123....	\$34.20	\$28.50



**Pair of Handles**  
Crane-Recpal

**B-25**  
Index Button  
92-2001  
Handle Screw  
4-3/8" x 3/4"

Packaging	Product #	each	6 plus
bag	97-4165....	\$34.20	\$28.50

**Pair of Handles OEM**  
CRANE PLUMBING

**B-25**  
Index Button  
92-2001  
5 15/16" x 1 1/8"

Packaging	Product #	each
bag	97-6165....	\$165.00



**Pair of Handles**  
Delta



**B-13**  
Index Button  
92-5009  
Handle Screw  
72-0214  
4" x 1-5/8"

Packaging	Product #	each	6 plus
bag	97-7404....	\$30.60	\$25.50

**Pair of Handles**  
Dominion

**20 pt. B-20**  
Index Button  
92-5009  
Handle Screw  
72-0214  
4" x 1-5/8"

Packaging	Product #	each	6 plus
bag	97-9009....	\$28.80	\$24.00

**Pair of Handles**  
Dominion



**B-53**  
Index Button  
92-5009  
Handle Screw  
72-0606  
2-13/16" x 2-1/8"

Packaging	Product #	each	6 plus
bag	97-1190....	\$45.00	\$37.50

**Pair of Handles**  
Dominion



**B-53**  
Index Button  
92-5009  
Handle Screw  
72-0606  
Satin  
2-13/16" x 2-1/8"

Packaging	Product #	each	6 plus
bag	97-1190BN....	\$36.00	\$30.00

**Pair of Handles**  
Dominion



**B-13**  
Index Button  
92-5009  
Handle Screw  
72-0606  
3" x 2-1/2"

Packaging	Product #	each	6 plus
bag	97-2890....	\$46.80	\$39.00



**Pair of Handles**  
Dominion



**B-13**  
Index Button  
92-5009  
Handle Screw  
72-0606  
3" x 2-1/2"

Packaging	Product #	each
bag	97-2890BN....	\$46.80



**Pair of Handles**  
Dominion

**B-13**  
Index Button  
92-5009  
Handle Screw  
72-0211  
4" x 1-1/2"

Packaging	Product #	each
bag	97-3100....	\$21.60

**Pair of Handles for 77-3293**  
Dominion

**B-13**  
Index Button  
92-5009  
Handle Screw  
72-0211  
4" x 1-1/2"

Packaging	Product #	each
bag	97-2301....	\$25.20

HONEST MERCHANDISE-ETHICALLY REPRESENTED: KISSLER & CO. INC. established 1923 makes and distributes precision replacement parts of it's own manufacture and procurement. Brand names, model names, original manufacturers' name or stock numbers, which may appear on Seller's invoices, catalogs, packages, quotations or correspondence, are so utilized for identification purposes only; and are not a warranty or representation, either expressed or implied, that items offered or sold are genuine products of such original manufacturers

Pair of Handles for 77-3291



Dominion



Packaging	Product #	each
bag	97-2301BN....	\$28.80

Pair of Handles for 77-3400



Dominion



Packaging	Product #	each	6 plus
bag	97-3400....	\$25.20	\$21.00

Pair of Handles for 77-5505



Dominion



Packaging	Product #	each
bag	97-5500BN....	\$28.80

Pair of Handles for 77-5700



Dominion



Packaging	Product #	each	6 plus
bag	97-5700....	\$25.20	\$21.00

Pair of Handles for 77-5705



Dominion



Packaging	Product #	each
bag	97-5700BN....	\$28.80

Pair of Handles



Eljer



Handle Screw  
72-0212  
4" x 11/16"

Packaging	Product #	each	6 plus
bag	97-4142....	\$54.00	\$45.00

Pair of Handles OEM

GERBER.



Handle Screw  
72-0212  
1-7/8" x 9/16"

Packaging	Product #	each
bag	97-0150....	\$16.50

Pair of Handles

Gerber



Index Button  
92-5009  
Handle Screw  
72-0212  
4-1/16" x 1-1/4"

Packaging	Product #	each	6 plus	50 plus
bag	97-4152....	\$27.00	\$22.50	\$17.40
clam	979-4152....	\$28.50	\$24.00	

Pair of Handles OEM

GERBER.



Index Button  
Handle Screw  
4-1/16" x 1-1/4"

Packaging	Product #	each
bag	KGR98-879....	\$63.00

Pair of Handles

Kohler



Handle Screw  
72-0112  
1-7/8" x 5/8"

Packaging	Product #	each	6 plus	50 plus
bag	97-0183....	\$32.40	\$27.00	

Diverter

Kohler



Handle Screw  
72-0112  
1-7/8" x 5/8"

Packaging	Product #	each	6 plus
bag	97-0183D....	\$16.20	\$13.50

Pair of Handles

Kohler





Handle Screw  
72-0112  
4-15/16" x 2-1/8"

Packaging	Product #	each	6 plus
bag	97-4187....	\$54.00	\$45.00

HONEST MERCHANDISE-ETHICALLY REPRESENTED: KISSLER & CO. INC. established 1923 makes and distributes precision replacement parts of it's own manufacture and procurement. Brand names, model names, original manufacturers' name or stock numbers, which may appear on Seller's invoices, catalogs, packages, quotations or correspondence, are so utilized for identification purposes only: and are not a warranty or representation, either expressed or implied, that items offered or sold are genuine products of such original manufacturers

**Pair of Handles**

**Moen**

20 pt. B-19



Handle Screw 72-0411

2-1/4" x 5/8"

Packaging	Product #	each	6 plus
bag	97-0999....	\$28.80	\$24.00

**Pair of Handles**

**T & S**

20 pt. B-20

Index Button



Handle Screw 72-0411

2-1/4" x 5/8"

Packaging	Product #	each	6 plus	50 plus	100 plus
bag	97-2063....	\$13.50	\$11.25	\$8.70	
clam	797-2063....	\$15.00	\$12.75		

**Pair of Handles**

**T & S**

20 pt. B-20



Handle Screw 72-0411

4" x 7/8"

Packaging	Product #	each	6 plus
bag	97-4063....	\$36.00	\$30.00

**Pair of Handles**

**T & S**

20 pt. B-20

Handle Screw 72-0411

6" x 7/8"

Packaging	Product #	each	6 plus
bag	97-6063....	\$54.00	\$45.00

**Pair of Handles**

**Sterling**



Handle Screw 72-0412

2" x 7/16"

Packaging	Product #	each	6 plus
bag	97-0280....	\$12.90	\$10.80

**Pair of Handles**

**American Standard**



22 pt. B-8

Index Button 92-2002

Handle Screw 72-0215

1-3/8" x 7/8"

Packaging	Product #	each	6 plus	50 plus
bag	96-0100....	\$32.40	\$27.00	\$19.80
clam	796-0100....	\$33.90	\$28.50	

**Diverter**

**American Standard**



22 pt. B-8

Index Button 92-2002D



Handle Screw 72-0215

1-3/8" x 7/8"

Packaging	Product #	each	6 plus	50 plus
bag	96-0100D....	\$16.20	\$13.50	\$9.90
clam	796-0100D....	\$17.70		

**Pair of Handles OEM**

**American Standard**

22 pt. 3/8 00

Index Button 92-2002



Handle Screw 72-0215

1-3/8" x 7/8"

Packaging	Product #	each
bag	96-1100....	\$76.80

**Pair of Handles**

**American Standard**

22 pt. B-8

Index Button 92-2114

Handle Screw 72-0216

1-1/4" x 1-1/8"

Packaging	Product #	each
bag	96-1105....	\$28.80

**Pair of Handles**

**American Standard**



22 pt. B-8

Index Button

Handle Screw 72-0212

1-3/8" x 9/16"

Packaging	Product #	each	6 plus	50 plus
bag	96-1816....	\$14.40	\$12.00	\$9.00

**Diverter**

**American Standard**



22 pt. B-8

Index Button

Handle Screw 72-0212

1-3/8" x 9/16"

Packaging	Product #	each	6 plus
bag	96-1816D....	\$7.20	\$6.00

**Pair of Handles**

**Briggs**



18 pt. B-22

Index Button 92-2113

Handle Screw 72-0312

1-7/16" x 7/8"

Packaging	Product #	each	6 plus
bag	96-0132....	\$24.30	\$20.10
clam	796-0132....	\$25.80	

HONEST MERCHANDISE-ETHICALLY REPRESENTED: KISSLER & CO. INC. established 1923 makes and distributes precision replacement parts of it's own manufacture and procurement. Brand names, model names, original manufacturers' name or stock numbers, which may appear on Seller's invoices, catalogs, packages, quotations or correspondence, are so utilized for identification purposes only; and are not a warranty or representation, either expressed or implied, that items offered or sold are genuine products of such original manufacturers

**Diverter**  
**Briggs**



  
18 pt.  
B-22  
Index Button  
92-2113D  
Handle Screw  
72-0312  
1-7/16" x 7/8"

Packaging	Product #	each	6 plus
bag	96-0132D ....	\$12.15	\$10.05

**Pair of Handles**  
**Gerber**



  
16 pt.  
B-18  
Index Button  
92-2003  
Handle Screw  
72-0212  
1-1/2" x 3/4"

Packaging	Product #	each	6 plus	50 plus
bag	96-0150 ....	\$15.00	\$12.60	\$9.60
clam	796-0150 ....	\$18.00		

**Diverter**  
**Gerber**



  
16 pt.  
B-18  
Index Button  
92-2003D  
Handle Screw  
72-0212  
1-1/2" x 3/4"

Packaging	Product #	each	6 plus
bag	96-0150D ....	\$7.50	\$6.30

**Pair of Handles**  
**Kohler**



  
19 pt.  
B-33  
Handle Screw  
72-0112  
1-3/8" x 9/16"

Packaging	Product #	each	6 plus	50 plus
bag	96-0182 ....	\$39.60	\$33.00	

**Diverter**  
**Kohler**



  
19 pt.  
B-33  
Handle Screw  
72-0112  
1-3/8" x 9/16"

Packaging	Product #	each	6 plus
bag	96-0182D ....	\$19.80	\$16.50

**Pair of Handles**  
**Price Pfister**



  
12 pt.  
B-6  
Index Button  
92-2003  
Handle Screw  
72-0211  
1-3/8" x 1/2"

Packaging	Product #	each	6 plus
bag	96-0215 ....	\$14.40	\$12.00
clam	796-0215 ....	\$17.40	

**Diverter**  
**Price Pfister**



  
12 pt.  
B-6  
Index Button  
92-2003D  
Handle Screw  
72-0211  
1-3/8" x 1/2"

Packaging	Product #	each	6 plus
bag	96-0215D ....	\$7.20	\$6.00

**Pair of Handles OEM**  
**SPEAKMAN®**



  
20 pt.  
B-20  
Index Button  
1-1/2" x 9/16"

Packaging	Product #	each
bag	96-0260 ....	\$153.00

**Pair of Handles OEM**  
**SPEAKMAN®**



  
20 pt.  
B-20  
Index Button  
92-2151  
Handle Screw  
72-0212  
1-1/2" x 7/8"

Packaging	Product #	each
bag	96-0263 ....	\$180.00

**Pair of Handles**  
**T & S**



  
20 pt.  
B-20  
Handle Screw  
72-0411  
1-5/16" x 3/4"

Packaging	Product #	each	6 plus
bag	96-2063 ....	\$21.60	\$18.00

**Single Lever OEM**  
**American Standard**



3-1/4" x 13/16"

Packaging	Product #	each
bag	46-9001 ....	\$51.00

**Single Lever OEM**  
**American Standard**



3-1/4" x 13/16"

Packaging	Product #	each
bag	46-9002 ....	\$63.00

HONEST MERCHANDISE-ETHICALLY REPRESENTED: KISSLER & CO. INC. established 1923 makes and distributes precision replacement parts of it's own manufacture and procurement. Brand names, model names, original manufacturers' name or stock numbers, which may appear on Seller's invoices, catalogs, packages, quotations or correspondence, are so utilized for identification purposes only; and are not a warranty or representation, either expressed or implied, that items offered or sold are genuine products of such original manufacturers



**Most Common**

**Single Lever**  
American Standard



**B-21**  
Index Button

Handle Screw  
72-0605

**3-1/4" x 1-11/16"**

Packaging	Product #	each	6 plus
bag	46-0105 ....	\$25.20	\$21.00
clam	746-0105 ....	\$26.70	\$22.50

**Single Lever**  
American Standard



**B-21**  
Index Button

Handle Screw  
72-0605

**4-7/8" x 1- 1/16"**

Packaging	Product #	each	6 plus
bag	46-1105 ....	\$28.80	\$24.00
clam	746-1105 ....	\$30.30	

**Single Lever**  
American Standard



**B-17**  
Index Button

Handle Screw  
72-0606

**5-1/4" x 9/16"**

Packaging	Product #	each	6 plus
bag	46-0106 ....	\$19.80	\$16.50

**Single Lever**  
American Standard



**B-17**  
Index Button

Handle Screw  
72-0606

**4" x 9/16"**

Packaging	Product #	each	6 plus
bag	46-0107 ....	\$18.00	\$15.00
clam	746-0107 ....	\$21.00	

**Single Lever**  
American Standard



**B-19**  
Index Button

Handle Screw  
72-0606

**4-1/8" x 3/4"**

Packaging	Product #	each	6 plus
bag	46-0108 ....	\$22.50	\$18.75

**Single Lever**  
American Standard



**12 pt. B-41**  
Index Button

Handle Screw  
72-0606

**4-1/8" x 3/4"**

Packaging	Product #	each	6 plus
bag	46-0109 ....	\$22.50	\$18.75

**Single Lever**  
American Standard



**B-17**  
Index Button

92-5268  
Handle Screw  
72-0211

**3-1/4" x 1-1/8"**

Packaging	Product #	each	6 plus
bag	46-0110 ....	\$27.45	\$22.80

**Single Lever**  
American Standard



**B-17**

**4 1/2" x 2 1/2"**

Packaging	Product #	each
bag	46-6024 ....	\$36.00

**Single Lever**  
American Standard



**B-17**

**4" X 4"**

Packaging	Product #	each
bag	46-3042 ....	\$24.00

**Single Lever**  
American Standard



**B-17**  
Index Button

Handle Screw  
72-0605

**5-1/8"**

Packaging	Product #	each
bag	46-0112 ....	\$7.20

**Single Lever**  
American Standard



**B-19**  
Index Button

92-5260  
Handle Screw  
72-0212

**1 1/4" X 1 7/8"**

Packaging	Product #	each	6 plus
bag	46-0114 ....	\$11.40	\$9.45

**Single Lever OEM**  
*American Standard*



**B-17**  
Index Button

92-5260

**1-1/4" x 2-1/4"**

Packaging	Product #	each
bag	46-0115 ....	\$19.50

HONEST MERCHANDISE-ETHICALLY REPRESENTED: KISSLER & CO. INC. established 1923 makes and distributes precision replacement parts of it's own manufacture and procurement. Brand names, model names, original manufacturers' name or stock numbers, which may appear on Seller's invoices, catalogs, packages, quotations or correspondence, are so utilized for identification purposes only; and are not a warranty or representation, either expressed or implied, that items offered or sold are genuine products of such original manufacturers

**Single Lever**  
American Standard



**B-7**  
Index Button

Handle Screw  
72-0701

1-3/8" x 3/4"

Packaging	Product #	each
bag	46-0116 ....	\$15.00

**Single Lever**  
American Standard





**B-7**  
Index Button

Handle Screw  
72-0702

2-5/8" x 2"

Packaging	Product #	each	6 plus
bag	46-0117 ....	\$24.30	\$20.25

**Single Lever OEM**  
American Standard

**B-17**

3-3/8" x 1-1/16"

Packaging	Product #	each
bag	46-0111 ....	\$52.50

**Single Lever**  
American Standard



**B-17**

Handle Screw  
72-0212

1-3/32" x 2"

Packaging	Product #	each	6 plus
bag	46-0118 ....	\$14.40	\$12.00

**Single Lever**  
American Standard





**16 pt. B-12**

Handle Screw  
72-0261

1-7/3" x 2-11/16"

Packaging	Product #	each	6 plus
bag	46-1118 ....	\$25.20	\$21.00

**Single Lever**  
American Standard





**B-17**

4 1/2" x 1 1/2"

Packaging	Product #	each
bag	46-8524 ....	\$24.00

**Single Lever**  
American Standard

**B-17**

4' X 4"

Packaging	Product #	each
bag	46-6099 ....	\$24.00

**Single Lever**  
Bradley



**10 pt. B-32**  
Index Button

92-5270

Handle Screw  
72-0212

1-1/2" x 2"

Packaging	Product #	each	6 plus
bag	46-0127 ....	\$11.40	\$9.45
clam	746-0127 ....	\$12.90	\$10.95

**Single Lever OEM**



**B-43**

Packaging	Product #	each
bag	46-4000 ....	\$45.00

**Single Lever OEM**



**B-43**

Packaging	Product #	each
bag	46-4013 ....	\$45.00

**Single Lever**  
Comco



**B-7**  
Index Button

Handle Screw  
72-0606

4-3/4"

Packaging	Product #	each	6 plus
bag	46-0132 ....	\$12.60	\$10.50
clam	746-0132 ....	\$14.10	

**Single Lever**  
Comco



**B-7**  
Index Button

Handle Screw  
72-0606

4-3/4"

Packaging	Product #	each	6 plus
bag	46-1132 ....	\$12.60	\$10.50
clam	746-1132 ....	\$15.00	

HONEST MERCHANDISE-ETHICALLY REPRESENTED: KISSLER & CO. INC. established 1923 makes and distributes precision replacement parts of it's own manufacture and procurement. Brand names, model names, original manufacturers' name or stock numbers, which may appear on Seller's invoices, catalogs, packages, quotations or correspondence, are so utilized for identification purposes only; and are not a warranty or representation, either expressed or implied, that items offered or sold are genuine products of such original manufacturers



**Single Lever**  
**Delta-Delex**



**B-19**

Packaging	Product #	each	6 plus
bag	46-6117 ....	\$18.90	\$15.75

**Single Lever OEM**

**B-7**

Handle Screw  
72-0606  
**3-3/4"**

Packaging	Product #	each	6 plus
bag	46-7443 ....	\$50.40	\$42.00

**COMPARE TO OEM**

**Single Lever**  
**Delta-Delex**



**B-19**

Handle Screw  
72-0606  
**3-1/2"**

Packaging	Product #	each	6 plus
bag	46-0079 ....	\$26.10	\$21.75
clam	746-0079 ....	\$27.60	\$23.25

**Single Lever OEM**



**B-19**

Handle Screw  
72-0606  
**3-1/2"**

Packaging	Product #	each
bag	KRP79 ....	\$54.00

**Single Lever OEM**





**B-7**

Handle Screw  
72-0606  
**3-3/8"**

Packaging	Product #	each	6 plus
bag	46-0090 ....	\$47.70	\$39.75

**Single Lever OEM**





**B-7**

**5-1/4"**

Packaging	Product #	each	6 plus
bag	46-2393 ....	\$45.00	\$37.50

**Single Lever**  
**Delta-Delex**

**B-7**

**Index Button**

Handle Screw  
72-0606  
**7"**

Packaging	Product #	each	6 plus
bag	46-5645 ....	\$21.60	\$18.00



**Single Lever OEM**



**B-7**

Packaging	Product #	each
bag	46-1874 ....	\$52.65

**Single Lever OEM**

**B-7**

Packaging	Product #	each
bag	46-8898 ....	\$69.00

**Single Lever OEM**



**B-7**

Packaging	Product #	each
bag	46-6919 ....	\$36.00

**COMPARE TO OEM**

**Single Lever**  
**Delta-Delex**



**B-5**

**Index Button**

Handle Screw  
72-0606  
**1-3/8" x 2-3/8"**

Packaging	Product #	each	6 plus
bag	46-9389 ....	\$11.55	\$9.60
clam	746-9389 ....	\$13.05	\$11.10

**Single Lever OEM**



**B-5**

**1-3/8" x 2-3/8"**

Packaging	Product #	each
bag	KRP2389 ....	\$33.75

HONEST MERCHANDISE-ETHICALLY REPRESENTED: KISSLER & CO. INC. established 1923 makes and distributes precision replacement parts of it's own manufacture and procurement. Brand names, model names, original manufacturers' name or stock numbers, which may appear on Seller's invoices, catalogs, packages, quotations or correspondence, are so utilized for identification purposes only: and are not a warranty or representation, either expressed or implied, that items offered or sold are genuine products of such original manufacturers

**COMPARE TO OEM**

**Single Lever Offset Broach**

**Delta-Delex**



**B-5**  
**Index Button**

**Handle Screw**  
72-0606

**1-1/2" x 2-1/2"**

Packaging	Product #	each	6 plus	50 plus
bag	46-9391 ....	\$11.55	\$9.60	\$7.50
clam	746-9391 ....	\$13.05	\$11.10	

**Single Lever OEM Offset Broach**





**B-5**

**1-1/2" x 2-1/2"**

Packaging	Product #	each
bag	KRP2391 ....	\$32.40

**COMPARE TO OEM**

**Single Lever**

**Delta-Delex**



**B-19**  
**Index Button**

**Handle Screw**  
72-0606

**1-1/2" x 2-1/2"**

Packaging	Product #	each	6 plus	50 plus
bag	46-9392 ....	\$11.55	\$9.60	\$7.50
clam	746-9392 ....	\$13.05	\$11.10	

**Single Lever OEM**





**B-19**

**1-1/2" x 2-1/2"**

Packaging	Product #	each
bag	KRP2392 ....	\$34.65

**Single Lever OEM**





**B-19**

Packaging	Product #	each	6 plus	50 plus
bag	46-7451 ....	\$13.80	\$11.50	\$0.00

**Single Lever for 77-3106**

**Dominion**





**B-7**

**Handle Screw**  
72-0606

Packaging	Product #	each	6 plus
bag	46-1181 ....	\$12.60	\$10.50

**Single Lever for 77-1180**

**Dominion**



**B-7**

**Handle Screw**  
72-0606

Packaging	Product #	each
bag	46-1181BN ....	\$21.60

**Single Lever for 77-3105**

**Dominion**

**B-45**

**Handle Screw**  
72-0606

Packaging	Product #	each	6 plus
bag	46-3105 ....	\$25.20	\$21.00

**Single Lever for 77-1850/1851**

**Dominion**



**B-45**

**Handle Screw**  
72-0606

Packaging	Product #	each	6 plus
bag	46-1851 ....	\$19.80	\$16.50

**Single Lever for 77-1632**

**Dominion**



**B-7**

**Handle Screw**  
72-0606

Packaging	Product #	each
bag	46-1851BN ....	\$21.60

**Single Lever Satin Nickel**

**Dominion**



**B-45**

**Handle Screw**  
72-0606

**for 77-3850/3851**

Packaging	Product #	each
bag	46-3850 ....	\$25.20

**Single Lever for 77-3005/3007**

**Dominion**



**B-7**  
**Index Button**  
92-0139

**Handle Screw**  
72-0606

Packaging	Product #	each	6 plus
bag	46-3005 ....	\$18.00	\$15.00

HONEST MERCHANDISE-ETHICALLY REPRESENTED: KISSLER & CO. INC. established 1923 makes and distributes precision replacement parts of it's own manufacture and procurement. Brand names, model names, original manufacturers' name or stock numbers, which may appear on Seller's invoices, catalogs, packages, quotations or correspondence, are so utilized for identification purposes only: and are not a warranty or representation, either expressed or implied, that items offered or sold are genuine products of such original manufacturers

**Single Lever for 77-3100**

Dominion



Packaging	Product #	each	6 plus
bag	46-3101 ....	\$18.00	\$15.00

**Single Lever for 77-2100**

Dominion



Packaging	Product #	each
bag	46-2000 ....	\$25.20

**Single Lever for 77-1183/1189**

Dominion



Packaging	Product #	each	6 plus
bag	46-1183 ....	\$19.80	\$16.50

**Single Lever for 77-1626/1631**

Dominion



Packaging	Product #	each
bag	46-1184 ....	\$19.80

**Single Lever for 77-1903**

Dominion



Packaging	Product #	each	6 plus
bag	46-1903 ....	\$19.80	\$16.50

**Single Lever for 77-1910**

Dominion



Packaging	Product #	each
bag	46-1903BN ....	\$21.60

**Single Lever for 77-2110**

Dominion



Packaging	Product #	each
bag	46-2110BN ....	\$21.60

**Single Lever for 77-2115**

Dominion



Packaging	Product #	each
bag	46-2115 ....	\$19.80

**Single Lever for 77-2120/2125**

Dominion



Packaging	Product #	each
bag	46-2115BN ....	\$21.60

**Single Lever for 77-3805/3810**

Dominion



Packaging	Product #	each
bag	46-3805 ....	\$19.80

**Single Lever for 77-3810/4219**

Dominion



Packaging	Product #	each
bag	46-3810 ....	\$25.20

**Single Lever OEM**

**Eljer**



Index Button  
92-5271  
Handle Screw

3" x 2"

Packaging	Product #	each
bag	46-6199 ....	\$48.00

HONEST MERCHANDISE-ETHICALLY REPRESENTED: KISSLER & CO. INC. established 1923 makes and distributes precision replacement parts of it's own manufacture and procurement. Brand names, model names, original manufacturers' name or stock numbers, which may appear on Seller's invoices, catalogs, packages, quotations or correspondence, are so utilized for identification purposes only; and are not a warranty or representation, either expressed or implied, that items offered or sold are genuine products of such original manufacturers



**Single Lever**  
Gerber



**3-1/4" x 1-5/8"**

Packaging	Product #	each	6 plus
bag	46-0152....	\$36.00	\$30.00



**Single Lever OEM**  
GERBER.



**5-3/8" x 1-5/8"**

Packaging	Product #	each
bag	46-1152....	\$66.00

**Single Lever OEM**  
GERBER.

**B-17**

Handle Screw

**1-3/8" x 2"**

Packaging	Product #	each
bag	46-0153....	\$37.50

**COMPARE TO OEM**

**Single Lever**  
Gerber



**B-19**

Packaging	Product #	each	6 plus
bag	46-5163....	\$36.00	\$30.00

**Single Lever OEM**  
GERBER.



**B-19**

Packaging	Product #	each
bag	KGR95-163....	\$74.40

**Most Common**

**Single Lever**  
Gerber



**B-19**

Packaging	Product #	each	6 plus
bag	46-7020....	\$43.20	\$36.00

**Single Lever**  
Imported



**B-7**

Index Button  
92-0139

Handle Screw  
72-0606

Packaging	Product #	each	6 plus
bag	46-0139....	\$18.00	\$15.00

**Single Lever**  
Kohler



**B-17**



Index Button  
92-5212

Handle Screw  
72-0211

**1-1/8" x 1-7/8"**

Packaging	Product #	each	6 plus
bag	46-0164....	\$27.00	\$22.50

**Single Lever**  
Kohler

**19 pt. B-33**



Index Button  
92-5111

Handle Screw  
72-0112

**1-1/4" x 2-1/2"**

Packaging	Product #	each	6 plus	50 plus
bag	46-0163....	\$11.70	\$9.75	\$7.50

**Single Lever**  
Kohler

**B-43**

Index Button  
92-5212

**1-5/16" x 2-7/8"**

Packaging	Product #	each	6 plus
bag	46-0168....	\$28.80	\$24.00

**Single Lever**  
Kohler



**B-17**

Index Button  
92-5213

Handle Screw  
72-0211

**1-1/4" x 1-7/8"**

Packaging	Product #	each	6 plus
bag	46-1164....	\$10.35	\$8.55

**Single Lever**  
Kohler



**19 pt. B-33**

Packaging	Product #	each
bag	46-6987....	\$30.00

HONEST MERCHANDISE-ETHICALLY REPRESENTED: KISSLER & CO. INC. established 1923 makes and distributes precision replacement parts of it's own manufacture and procurement. Brand names, model names, original manufacturers' name or stock numbers, which may appear on Seller's invoices, catalogs, packages, quotations or correspondence, are so utilized for identification purposes only; and are not a warranty or representation, either expressed or implied, that items offered or sold are genuine products of such original manufacturers

**Single Lever**

**Milwaukee**



**B-19**

**Index Button**  
92-5217

**Handle Screw**  
72-0112

**1-3/8" x 2-3/8"**

Packaging	Product #	each	6 plus
bag	46-0171 ....	\$17.40	\$14.40
clam	746-0171 ....	\$18.90	

**Single Lever**

**Mixet**



**B-21**

Packaging	Product #	each	6 plus
bag	46-0177 ....	\$28.80	\$24.00

**Single Lever**

**Mixet**



**B-19**

**1-3/8" x 2-1/4"**

Packaging	Product #	each	6 plus
bag	46-0175 ....	\$14.85	\$12.30

**Single Lever**

**Mixet**



**B-19**

**Handle Screw**  
72-0112

Packaging	Product #	each	6 plus
bag	46-0176 ....	\$12.00	\$9.90
clam	746-0176 ....	\$13.50	

**Single Lever**

**Mixet**



**B-19**

**Handle Screw**  
72-0112

**1-3/16" x 1"**

Packaging	Product #	each	6 plus	50 plus	100 plus
bag	46-0174 ....	\$5.10	\$4.20	\$3.30	\$3.00
clam	746-0174 ....	\$6.60	\$5.70		

**Single Lever (Smoke)**

**Mixet**



**B-19**

**Handle Screw**  
72-0112

**1-3/16" x 1"**

Packaging	Product #	each	6 plus	50 plus	100 plus
bag	46-0174SM ....	\$5.10	\$4.20		
clam	746-0174SM ....	\$6.60	\$5.70		

**Single Lever**

**Mixet**



**B-19**

**Handle Screw**  
72-0112

**2-1/4" x 1-5/8"**

Packaging	Product #	each	6 plus
bag	46-1174 ....	\$10.20	\$8.40
clam	746-1174 ....	\$11.70	\$9.90

**Single Lever (Smoke)**

**Mixet**



**B-19**

**Handle Screw**  
72-0112

**2-1/4" x 1-5/8"**

Packaging	Product #	each	6 plus
bag	46-1174SM ....	\$14.40	\$12.00

**Single Lever**

**Mixet**



**B-19**

**2-1/4" x 15/16"**

Packaging	Product #	each	6 plus	50 plus	100 plus
bag	46-3174 ....	\$5.10	\$4.20	\$3.30	\$3.00
clam	746-3174 ....	\$6.60	\$5.70		

**Single Lever (Smoke)**

**Mixet**



**B-19**

**2-1/4" x 15/16"**

Packaging	Product #	each	6 plus
bag	46-3174SM ....	\$9.00	\$7.50
clam	746-3174SM ....	\$12.00	

**Single Lever**

**Mixet**



**B-19**

**Handle Screw**  
72-0112

**3-13/16" x 1-1/2"**

Packaging	Product #	each	6 plus
bag	46-2174 ....	\$16.50	\$13.65

**Single Lever (Smoke)**

**Mixet**



**B-19**

**Handle Screw**  
72-0112

**3-13/16" x 1-1/2"**

Packaging	Product #	each
bag	46-2174SM ....	\$16.50

HONEST MERCHANDISE-ETHICALLY REPRESENTED: KISSLER & CO. INC. established 1923 makes and distributes precision replacement parts of it's own manufacture and procurement. Brand names, model names, original manufacturers' name or stock numbers, which may appear on Seller's invoices, catalogs, packages, quotations or correspondence, are so utilized for identification purposes only: and are not a warranty or representation, either expressed or implied, that items offered or sold are genuine products of such original manufacturers

**Single Lever**  
**Mixet**



**B-19**

3-13/16" x 3/4"

Packaging	Product #	each	6 plus
bag	46-4174....	\$12.60	\$10.50
clam	746-4174....	\$14.10	\$12.00

**Single Lever**  
**Moen**



**B-19**

4" X 2"

Packaging	Product #	each
bag	46-0657....	\$54.00

**Single Lever**  
**Moen**



**B-19**

3 1/2" X 2 7/8"

Packaging	Product #	each
bag	46-0679....	\$126.00

**Single Lever**  
**Moen**



**B-19**

**Index Button**  
92-5253  
**Handle Screw**  
72-0212

Short Broach 1-1/4" x 1-11/16"

Packaging	Product #	each	6 plus	50 plus
bag	46-3092....	\$8.40	\$6.90	\$5.40
clam	746-3092....	\$9.90		

**Most Common**

**Single Lever**  
**Moen**



**B-19**

**Index Button**  
92-5253  
**Handle Screw**  
72-0232

Long Broach 1-3/8" x 1-3/4"

Packaging	Product #	each	6 plus	50 plus
bag	46-3094....	\$8.40	\$6.90	\$5.40
clam	746-3094....	\$9.90	\$8.40	

**Single Lever**  
**Moen**



**B-19**

**Index Button**  
92-5259  
**Handle Screw**  
72-0212

Short Broach 1 1/4" X 1 9/16"

Packaging	Product #	each	6 plus
bag	46-3103....	\$9.00	\$7.50
clam	746-3103....	\$10.50	\$9.00

**Single Lever**  
**Moen**



**B-19**

**Index Button**  
92-5259  
**Handle Screw**  
72-0232

Long Broach 1-5/16" x 1-9/16"

Packaging	Product #	each	6 plus
bag	46-3104....	\$9.00	\$7.50
clam	746-3104....	\$10.50	\$9.00

**Most Common**

**Single Lever**  
**Moen**



**B-19**

**Index Button**  
92-5272  
**Handle Screw**  
72-0212

Short Broach 1-5/8" x 1-5/8"

Packaging	Product #	each	6 plus	50 plus	100 plus
bag	46-6791....	\$8.40	\$6.90	\$5.40	\$4.80
clam	746-6791....	\$9.90	\$8.40		

**Most Common**

**Single Lever**  
**Moen**



**B-19**

**Index Button**  
92-5272  
**Handle Screw**  
72-0232

Long Broach 1-5/8" x 1-5/8"

Packaging	Product #	each	6 plus	50 plus	100 plus
bag	46-6797....	\$8.40	\$6.90	\$5.40	\$4.80
clam	746-6797....	\$9.90	\$8.40		

**Most Common**

**Single Lever (Posi-Temp)**  
**Moen**



**B-19**

**Index Button**  
92-5272  
**Handle Screw**  
72-0232

Packaging	Product #	each	6 plus	50 plus	100 plus
bag	46-6884....	\$10.20	\$8.40	\$6.60	\$6.00
clam	746-6884....	\$11.70	\$9.90		

**Single Lever**  
**Moen**



**B-19**

4-1/2"

Packaging	Product #	each	6 plus
bag	46-6788....	\$10.80	\$9.00

**Single Lever**  
**Moen**



**B-19**

**Handle Screw**  
72-0222

7/8" x 1-5/8"

Packaging	Product #	each	6 plus
bag	46-6789....	\$7.05	\$5.85

HONEST MERCHANDISE-ETHICALLY REPRESENTED: KISSLER & CO. INC. established 1923 makes and distributes precision replacement parts of it's own manufacture and procurement. Brand names, model names, original manufacturers' name or stock numbers, which may appear on Seller's invoices, catalogs, packages, quotations or correspondence, are so utilized for identification purposes only: and are not a warranty or representation, either expressed or implied, that items offered or sold are genuine products of such original manufacturers

**Single Lever**  
Moen



**B-19**

Handle Screw  
72-0222  
4-1/2" x 1-5/8"

Packaging	Product #	each	6 plus
bag	46-6790 ....	\$20.70	\$17.25
clam	746-6790 ....	\$22.20	\$18.75

**Single Lever**  
Moen



**B-19**

2-5/8" x 1-1/4"

Packaging	Product #	each	6 plus
bag	46-6985 ....	\$20.70	\$17.25

**Single Lever**  
Moen



**B-19**

Long Broach  
Handle Screw  
72-0231  
2-3/4" x 1-1/4"

Packaging	Product #	each	6 plus
bag	46-3291 ....	\$22.35	\$18.60

**Single Lever**  
Moen



**B-19**

Handle Screw  
72-0231  
Short Broach  
2-3/4" x 1-1/4"

Packaging	Product #	each
bag	46-9393 ....	\$36.00

**Single Lever OEM**  
NIBCO  
AHEAD OF THE FLOW



**B-43**  
Index Button  
92-2153D

Packaging	Product #	each
bag	46-2177 ....	\$27.00

**Single Lever**  
Nibco



**Index Button**  
92-5254  
1-3/4" x 1-5/8"

Packaging	Product #	each	6 plus
bag	46-0179 ....	\$18.00	\$15.00

**Single Lever**  
Nibco



**B-43**  
Index Button  
92-5254  
2-3/8" x 1-3/4"

Packaging	Product #	each	6 plus
bag	46-2178 ....	\$8.10	\$6.75

**Single Lever**  
Peerless



**B-5**

Handle Screw  
72-0606  
3-1/4" x 7/8"

Packaging	Product #	each	6 plus
bag	46-7625 ....	\$16.50	\$13.65
clam	746-7625 ....	\$18.00	

**Single Lever**  
Price Pfister



**B-19**  
4"

Packaging	Product #	each	6 plus
bag	46-4511 ....	\$21.00	\$18.00

**Single Lever**  
Price Pfister



**B-19**  
Index Button  
92-5265  
Handle Screw  
72-0412  
3-1/4' x 7/8"

Packaging	Product #	each	6 plus
bag	46-4510 ....	\$21.60	\$18.00
clam	746-4510 ....	\$24.60	

**Single Lever**  
Price Pfister



**B-19**

Handle Screw  
72-0212  
3-1/4' x 7/8"

Packaging	Product #	each	6 plus
bag	46-4512 ....	\$13.05	

**Single Lever**  
Price Pfister



**B-17**  
3-1/4' x 7/8"

Packaging	Product #	each	6 plus
bag	46-4513 ....	\$10.80	\$9.00

HONEST MERCHANDISE-ETHICALLY REPRESENTED: KISSLER & CO. INC. established 1923 makes and distributes precision replacement parts of it's own manufacture and procurement. Brand names, model names, original manufacturers' name or stock numbers, which may appear on Seller's invoices, catalogs, packages, quotations or correspondence, are so utilized for identification purposes only; and are not a warranty or representation, either expressed or implied, that items offered or sold are genuine products of such original manufacturers



**Most Common**



**Single Lever**  
Price Pfister

**B-42**  
Index Button  
92-5255  
Handle Screw  
72-0212  
1-3/8" x 2"

Packaging	Product #	each	6 plus
bag	46-4516....	\$13.05	\$10.80
clam	746-4516....	\$14.55	\$12.30

**Most Common**



**Single Lever**  
Price Pfister

**B-42**  
Handle Screw  
72-0212

Packaging	Product #	each	6 plus
bag	46-4517....	\$13.35	\$11.10



**Single Lever**  
Price Pfister

**B-42**

4-1/2" x 1-3/4"

Packaging	Product #	each
bag	46-4515....	\$27.00



**Single Lever**  
Sayco

**B-43**

Packaging	Product #	each
bag	46-0327....	\$21.60

**Single Lever OEM**



**SPEAKMAN®**

**B-19**

1-3/4" x 1-3/4"

Packaging	Product #	each
bag	46-0193....	\$31.50



**Single Lever**  
Sterling

**B-43**

Handle Screw  
72-0214  
2-1/4" x 1- 1/2"

Packaging	Product #	each	6 plus
bag	46-5043....	\$25.20	\$21.00



**Single Lever**  
Sterling

**B-45**

1-1/16" x 1-7/8"

Packaging	Product #	each	6 plus
bag	46-0202....	\$9.60	\$7.95
clam	746-0202....	\$12.30	

**Most Common**



**Single Lever**  
Sterling

**B-45**

1-25/32" x 1- 3/4"

Packaging	Product #	each	6 plus
bag	46-0205....	\$11.40	\$9.45



**Single Lever**  
Sterling

**B-45**

Packaging	Product #	each	6 plus
bag	46-0206....	\$9.90	\$8.25



**Single Lever**  
Sterling

**B-46**  
Index Button  
92-5219  
Handle Screw  
72-0412  
1-3/16" x 2-1/8"

Packaging	Product #	each	6 plus
bag	46-0204....	\$11.40	\$9.45



**Single Lever**  
Symmons

**B-23**

Packaging	Product #	each	6 plus
bag	46-0217....	\$25.20	\$21.00



**Single Lever**  
Symmons

**12 pt. B-23**  
Index Button

Handle Screw  
72-0606  
3-1/4" x 1-1/2"

C-5 Temptrol

Packaging	Product #	each	6 plus
bag	46-0212....	\$16.95	\$14.10

HONEST MERCHANDISE-ETHICALLY REPRESENTED: KISSLER & CO. INC. established 1923 makes and distributes precision replacement parts of it's own manufacture and procurement. Brand names, model names, original manufacturers' name or stock numbers, which may appear on Seller's invoices, catalogs, packages, quotations or correspondence, are so utilized for identification purposes only: and are not a warranty or representation, either expressed or implied, that items offered or sold are genuine products of such original manufacturers



**Single Lever for RC-14x**

Symmons



12 pt. B-41  
Index Button

Handle Screw 72-0606

replace RC-14x 3-1/4" x 1-1/2"

Packaging	Product #	each	6 plus
bag	46-9212 ....	\$16.95	\$14.10

**Single Lever**

Symmons



B-5

4" x 2"

Packaging	Product #	each
bag	46-0211 ....	\$32.40

**Single Lever**

Symmons



B-5

5" x 3"

Packaging	Product #	each
bag	46-1211 ....	\$36.00

**Single Lever**

Symmons



12 pt. B-41  
Index Button

for TA-10 cartridge 1-5/8" x 1-1/4"

Packaging	Product #	each	6 plus
bag	46-0214 ....	\$23.40	\$19.50

**Single Lever (Die-Cast)**

Symmons



12 pt. B-41  
Index Button 92-2003D  
Handle Screw 72-0606

for TA-10 cartridge 2" x 1-1/4"

Packaging	Product #	each	6 plus	50 plus
bag	46-0215 ....	\$19.35	\$16.05	\$12.60
clam	746-0215 ....	\$20.85		

**Single Lever (Plastic)**

Symmons



12 pt. B-41  
Index Button 92-2003D  
Handle Screw 72-0606

for TA-10 cartridge 2" x 1-1/4"

Packaging	Product #	each	6 plus
bag	46-9215 ....	\$23.40	\$19.50

**Single Lever**

Symmons



Packaging	Product #	each
bag	46-6987 ....	\$30.00

**Single Lever**

Valley



B-7

Handle Screw 72-0606

3" x 1-3/4"

Packaging	Product #	each	6 plus	50 plus
bag	46-1165 ....	\$14.40	\$12.00	\$9.45
clam	746-1165 ....	\$15.90	\$13.50	

**Single Lever**

Valley



B-7

Handle Screw 72-0606

1-5/8" x 1-3/8"

Packaging	Product #	each	6 plus	50 plus	100 plus
bag	46-6679 ....	\$13.95	\$11.55	\$9.15	\$8.25
clam	746-6679 ....	\$15.45	\$13.05		

**Single Lever**

Valley



B-7  
Index Button 92-5210  
Handle Screw 72-0606

2" x 1-5/8"

Packaging	Product #	each	6 plus
bag	46-5002 ....	\$11.70	\$9.75
clam	746-5002 ....	\$14.55	

**Single Lever**

Valley



B-43  
Index Button 92-5210  
Handle Screw 72-0606

2" x 1-5/8"

Packaging	Product #	each	6 plus	50 plus	100 plus
bag	46-5022 ....	\$11.70	\$9.75	\$7.65	\$6.90
clam	746-5022 ....	\$13.20			

**Single Lever**

Valley



B-7  
Index Button 92-5210  
Handle Screw 72-0214

1-1/8" x 1-1/2"

Packaging	Product #	each	6 plus
bag	46-5014 ....	\$11.70	\$9.75
clam	746-5014 ....	\$13.20	

HONEST MERCHANDISE-ETHICALLY REPRESENTED: KISSLER & CO. INC. established 1923 makes and distributes precision replacement parts of it's own manufacture and procurement. Brand names, model names, original manufacturers' name or stock numbers, which may appear on Seller's invoices, catalogs, packages, quotations or correspondence, are so utilized for identification purposes only: and are not a warranty or representation, either expressed or implied, that items offered or sold are genuine products of such original manufacturers

**Single Lever**  
**Valley**



  
**B-43**  
Index Button  
92-5210  
Handle Screw  
72-0214  
**1-1/8" x 1-1/2"**

Packaging	Product #	each	6 plus
bag	46-5001....	\$11.70	\$9.75

**Single Lever**  
**Valley**



  
**B-43**  
Handle Screw  
72-0214  
**4" x 4-5/8"**

Packaging	Product #	each	6 plus	50 plus	100 plus
bag	46-1989....	\$21.60	\$18.00	\$13.95	\$12.60
clam	746-1989....	\$23.10			

**Single Lever**  
**Valley**



  
**20 pt. B-37**

Packaging	Product #	each
bag	46-4754....	\$22.50

**Pair of Handles**  
**American Brass**



  
**17 pt. B-26**  
Index Button  
92-5234  
Handle Screw  
72-0111  
**1" x 1-7/8"**

Packaging	Product #	each	6 plus
bag	95-0100....	\$21.60	\$18.00

**Pair of Handles OEM**  
**American Standard**



  
**16 pt. B-12**  
Index Button  
92-2003  
Handle Screw  
72-0232  
**1-1/8" x 2-1/2"**

Packaging	Product #	each
bag	95-2005....	\$48.00

**Pair of Handles OEM**  
**American Standard**



  
**16 pt. B-12**  
Index Button  
92-2003  
Handle Screw  
72-0232  
**1-1/4" x 3"**

Packaging	Product #	each
bag	95-1005....	\$82.50

**Diverter OEM**  
**American Standard**



  
**16 pt. B-12**  
Index Button  
92-2003D  
Handle Screw  
72-0212  
**1-1/4" x 3"**

Packaging	Product #	each
bag	95-1005D....	\$41.25

**Pair of Handles**  
**American Standard**



  
**16 pt. B-12**  
Index Button  
92-5228P  
Handle Screw  
72-0251  
**1-1/8" x 2-5/16"**

Packaging	Product #	each	6 plus	50 plus
bag	95-1002....	\$40.50	\$33.75	\$27.00
clam	795-1002....	\$42.00		

**Diverter**  
**American Standard**



  
**16 pt. B-12**  
Handle Screw  
72-0251  
**1-1/8" x 2-5/16"**

Packaging	Product #	each	6 plus
bag	95-1002D....	\$20.25	\$16.95

**Pair of Handles OEM**  
**American Standard**



  
**16 pt. B-12**  
Handle Screw  
72-0222  
**1-3/16" x 2-1/2"**

Packaging	Product #	each
bag	95-1007....	\$36.90

**Set of 3 Handles OEM**  
**American Standard**



  
**16 pt. B-12**  
Handle Screw  
72-0222  
**1-3/16" x 2-1/2"**

Packaging	Product #	each
bag	42592-0070A....	\$94.05

**Pair of Handles OEM**  
**American Standard**



  
**16 pt. B-12**  
Index Button  
92-2153  
Handle Screw  
**15/16" x 1-1/2"**

Packaging	Product #	each
bag	95-2006....	\$48.00

HONEST MERCHANDISE-ETHICALLY REPRESENTED: KISSLER & CO. INC. established 1923 makes and distributes precision replacement parts of it's own manufacture and procurement. Brand names, model names, original manufacturers' name or stock numbers, which may appear on Seller's invoices, catalogs, packages, quotations or correspondence, are so utilized for identification purposes only; and are not a warranty or representation, either expressed or implied, that items offered or sold are genuine products of such original manufacturers

**Pair of Handles OEM**  
*American Standard*



**16 pt. B-12**  
Index Button  
92-2153  
Handle Screw

1-1/8" x 1-7/8"

Packaging	Product #	each
bag	95-1006....	\$51.00

**Diverter OEM**  
*American Standard*



**16 pt. B-12**  
Index Button  
92-2153D

1-1/8" x 1-7/8"

Packaging	Product #	each
bag	95-1006D....	\$27.00

**Pair of Handles OEM**  
*American Standard*



**22 pt. B-8**  
Index Button  
92-2146  
Handle Screw  
72-0216

1-7/16" x 2-1/8"

Packaging	Product #	each
bag	95-1004....	\$94.50

**Pair of Handles**  
*American Standard*



1-7/16" x 2-1/8"

Packaging	Product #	each
bag	95-8413....	\$36.00

**Pair of Handles OEM**  
*BRIGGS*



**18 pt. B-22**  
Index Button  
92-2118  
Handle Screw  
72-0322

1 1/8" X 1 3/8"

Packaging	Product #	each
bag	95-0110....	\$37.50

**Pair of Handles OEM**  
*CRANE PLUMBING*



**12 pt. B-4**  
Index Button  
92-5229  
Handle Screw  
72-0112

1-3/16" x 1-1/2"

Packaging	Product #	each
bag	95-0124....	\$40.50

**Pair of Handles**  
*Crane-Repcal*



**12 pt. B-4**  
Handle Screw  
72-0112

1-1/8" x 1-1/2"

Packaging	Product #	each	6 plus
bag	95-0125....	\$19.80	\$16.50

**Pair of Handles**  
*Crane-Repcal*



**12 pt. B-4**  
Handle Screw  
72-0112

1-3/8" x 1-7/8"

Packaging	Product #	each	6 plus
bag	95-1125....	\$32.40	\$27.00

**Pair of Handles**  
*Crane-Repcal*



**12 pt. B-4**  
Handle Screw  
72-0112

1 1/4" X 1 5/8"

Packaging	Product #	each	6 plus
bag	95-3125....	\$32.40	\$27.00

**Pair of Handles OEM**  
*CRANE PLUMBING*



**12 pt. B-4**  
Handle Screw  
72-0112

15/16" x 1"

Packaging	Product #	each
bag	95-0123....	\$135.90

**Pair of Handles OEM**  
*CRANE PLUMBING*



**12 pt. B-4**  
Handle Screw  
72-0112

1-1/4" x 1-1/2"

Packaging	Product #	each
bag	95-1123....	\$170.70

**Diverter OEM**  
*CRANE PLUMBING*



**12 pt. B-4**  
Handle Screw  
72-0112

1-1/4" x 1-1/2"

Packaging	Product #	each
bag	95-1123D....	\$85.35

HONEST MERCHANDISE-ETHICALLY REPRESENTED: KISSLER & CO. INC. established 1923 makes and distributes precision replacement parts of it's own manufacture and procurement. Brand names, model names, original manufacturers' name or stock numbers, which may appear on Seller's invoices, catalogs, packages, quotations or correspondence, are so utilized for identification purposes only; and are not a warranty or representation, either expressed or implied, that items offered or sold are genuine products of such original manufacturers

**Most Common**

**Pair of Handles**

**Delta-Delex**



**B-13**  
Index Button  
92-5247  
Handle Screw  
72-0214  
**1-1/8" x 1-7/8"**

Packaging	Product #	each	6 plus	50 plus	100 plus
bag	95-1718....	\$9.00	\$7.50	\$6.00	\$5.40
clam	795-1718....	\$10.50	\$9.00		

**Diverter Handle**

**Delta-Delex**





**B-13**  
Index Button  
92-5247D  
Handle Screw  
72-0214  
**1-1/8" x 1-7/8"**

Packaging	Product #	each
bag	95-1718D....	\$6.00

**Pair of Handles**

**Delta-Delex**

**B-13**

offset broach

**1-1/8" x 1-7/8"**

Packaging	Product #	each
bag	95-4718....	\$21.60

**COMPARE TO OEM**

**Pair of Handles**

**Delta-Delex**



**B-13**

Handle Screw  
72-0214  
**1-1/8" x 1-7/8"**

Packaging	Product #	each	6 plus	50 plus
bag	95-5693....	\$10.80	\$9.00	\$7.20

**Pair of Handles OEM**





**B-13**

**1-1/8" x 1-7/8"**

Packaging	Product #	each
bag	KRP5693....	\$34.05

**Pair of Handles**

**Delta-Delex**



**B-13**  
Index Button  
92-5247  
Handle Screw  
72-0214  
**1-3/16" x 2-9/16"**

Packaging	Product #	each	6 plus
bag	95-3718....	\$12.60	\$10.50

**Pair of Handles OEM**





**B-13**  
Index Button  
92-5247  
Handle Screw  
72-0214  
**1-1/2" x 2-1/2"**

Packaging	Product #	each
bag	95-5218....	\$75.00

**COMPARE TO OEM**

**Pair of Handles**

**Delta-Delex**







**B-13**

Handle Screw  
72-0214  
**1-3/8" x 2-3/8"**

Packaging	Product #	each	6 plus
bag	95-9390....	\$19.80	\$16.50
clam	795-9390....	\$21.30	\$18.00

**Handle OEM**



**B-13**

**1-3/8" x 2-3/8"**

Packaging	Product #	each
bag	KRP2390....	\$36.15

**Pair of Handles**

**Eljer**





**1 1/2 pt. B-12**  
Index Button  
92-5237  
Handle Screw  
72-0212  
**1-3/8" x 2-3/8"**

Packaging	Product #	each	6 plus
bag	95-0130....	\$17.70	\$14.70

**Diverter**

**Eljer**

**1 1/2 pt. B-12**  
Index Button  
92-5237  
Handle Screw  
72-0212  
**1-3/8" x 2-3/8"**

Packaging	Product #	each	6 plus
bag	95-0130D....	\$8.85	\$7.35

**Pair of Handles**

**Gerber**



**1 1/2 pt. B-18**  
Index Button  
92-5009  
Handle Screw  
72-0212  
**1" x 1-3/4"**

Packaging	Product #	each	6 plus
bag	95-0142....	\$15.00	\$12.45
clam	795-0142....	\$16.50	

HONEST MERCHANDISE-ETHICALLY REPRESENTED: KISSLER & CO. INC. established 1923 makes and distributes precision replacement parts of it's own manufacture and procurement. Brand names, model names, original manufacturers' name or stock numbers, which may appear on Seller's invoices, catalogs, packages, quotations or correspondence, are so utilized for identification purposes only; and are not a warranty or representation, either expressed or implied, that items offered or sold are genuine products of such original manufacturers



**Pair of Handles**

**Gerber**



16 pt.  
B-18  
Index Button  
92-5009  
Handle Screw  
72-0212

Long Broach 1-1/4" x 2-5/8"

Packaging	Product #	each	6 plus
bag	95-0143....	\$16.20	\$13.50
clam	795-0143....	\$17.70	

**Diverter**

**Gerber**



16 pt.  
B-18  
Index Button  
92-5009D  
Handle Screw  
72-0212

Long Broach 1-1/4" x 2-5/8"

Packaging	Product #	each	6 plus
bag	95-0143D....	\$8.10	\$6.75

**Pair of Handles**

**Gerber**



16 pt.  
B-18  
Index Button  
92-5009  
Handle Screw  
72-0212

Short Broach 1-1/4" x 2-5/8"

Packaging	Product #	each	6 plus
bag	95-2143....	\$16.20	\$13.50
clam	795-2143....	\$17.70	

**Diverter**

**Gerber**



16 pt.  
B-18  
Index Button  
92-5009D  
Handle Screw  
72-0212

Short Broach 1-1/4" x 2-5/8"

Packaging	Product #	each	6 plus
bag	95-2143D....	\$8.10	\$6.75

**Pair of Handles**

**Kohler**



B-9  
Index Button  
92-5214S  
Handle Screw  
72-0112

1-1/8" x 2-1/8"

Packaging	Product #	each	6 plus
bag	95-0164....	\$24.90	\$20.70

**Pair of Handles**

**Kohler**



B-9  
Index Button  
92-5214S  
Handle Screw  
72-0112

1-1/4" x 2-15/16"

Packaging	Product #	each	6 plus
bag	95-1164....	\$29.70	\$24.75

**Pair of Handles**

**Kohler**



19 pt.  
B-33  
Index Button  
92-2133P  
Handle Screw  
72-0132

1-3/16" x 2-1/8"

Packaging	Product #	each	6 plus
bag	95-0165....	\$30.60	\$25.50

**Pair of Handles**

**Kohler**



19 pt.  
B-33  
Index Button  
92-2137P  
Handle Screw  
72-0142

1-3/8" x 2-13/16"

Packaging	Product #	each	6 plus
bag	95-1165....	\$39.60	\$33.00
clam	795-1165....	\$41.10	

**Pair of Handles OEM**

**KOHLER**



19 pt.  
B-33  
Index Button  
92-5269  
Handle Screw  
72-0132

1-3/16" x 3"

Packaging	Product #	each
bag	95-1167....	\$292.50

**Pair of Handles**

**Kohler**



16 pt.  
B-12  
Index Button  
92-5226  
Handle Screw  
72-0112

3/4" x 1-5/8"

Packaging	Product #	each	6 plus
bag	95-0166....	\$15.00	\$12.45
clam	795-0166....	\$16.50	

**Pair of Handles**

**Kohler**



16 pt.  
B-12  
Index Button  
92-5226  
Handle Screw  
72-0132

1-5/16" x 2-1/4"

Packaging	Product #	each	6 plus
bag	95-1166....	\$30.00	\$24.90
clam	795-1166....	\$31.50	\$26.40

**Diverter**

**Kohler**



16 pt.  
B-12  
Index Button  
92-5226D  
Handle Screw  
72-0132

1-5/16" x 2-1/4"

Packaging	Product #	each	6 plus
bag	95-1166D....	\$15.00	\$12.45

HONEST MERCHANDISE-ETHICALLY REPRESENTED: KISSLER & CO. INC. established 1923 makes and distributes precision replacement parts of it's own manufacture and procurement. Brand names, model names, original manufacturers' name or stock numbers, which may appear on Seller's invoices, catalogs, packages, quotations or correspondence, are so utilized for identification purposes only: and are not a warranty or representation, either expressed or implied, that items offered or sold are genuine products of such original manufacturers



**Pair of Handles**  
**Michigan Brass**



  
12 pt.  
B-24  
Index Button  
92-5246  
Handle Screw  
72-0112  
1" x 2-1/8"

Packaging	Product #	each	6 plus
bag	95-0170 ....	\$19.80	\$16.50

**Diverter**  
**Michigan Brass**



  
12 pt.  
B-24  
Index Button  
92-5246D  
Handle Screw  
72-0112  
1" x 2-1/8"

Packaging	Product #	each	6 plus
bag	95-0170D ....	\$9.90	\$8.25

**Pair of Handles**  
**Milwaukee**



  
B-9  
Index Button  
92-5226  
Handle Screw  
72-0723  
1-3/16" x 2-1/8"

Packaging	Product #	each	6 plus
bag	95-7540 ....	\$15.30	\$12.75
clam	795-7540 ....	\$16.80	

**Pair of Handles**  
**Moen**



  
17 pt.  
B-26  
Index Button  
92-5276P  
Handle Screw  
72-0122  
1-3/16" x 1-3/4"

Packaging	Product #	each	6 plus
bag	95-1801 ....	\$15.00	\$12.45
clam	795-1801 ....	\$16.50	



**Pair of Handles**  
**Moen**



  
B-9  
Index Button  
92-5243P  
Handle Screw  
72-0212  
1-3/16" x 2-1/8"

Packaging	Product #	each	6 plus
bag	95-3801 ....	\$15.00	\$12.45
clam	795-3801 ....	\$16.50	\$13.95

**Pair of Handles OEM**

  
B-9  
Index Button

Packaging	Product #	each
bag	95-3392 ....	\$60.75

**Most Common**  
**Pair of Handles**  
**Moen**



  
B-9  
Index Button

Packaging	Product #	each	6 plus
bag	95-3394 ....	\$16.20	\$13.50

**Most Common**  
**Pair of Handles**  
**Nibco**



  
17 pt.  
B-26  
Index Button  
92-5280  
Handle Screw  
72-0723  
1-3/16" x 2-1/16"

Packaging	Product #	each	6 plus	50 plus
bag	95-0178 ....	\$12.60	\$10.50	\$8.25
clam	795-0178 ....	\$14.10	\$12.00	

**Pair of Handles**  
**Price Pfister**



  
12 pt.  
B-6  
Index Button  
92-1186  
Handle Screw  
72-0211  
1-1/16" x 1-13/16"

Packaging	Product #	each	6 plus
bag	95-0186 ....	\$9.90	\$8.25

**Most Common**  
**Pair of Handles**  
**Price Pfister**



  
12 pt.  
B-6  
Index Button  
92-1186  
Handle Screw  
72-0211  
1-1/4" x 2-1/16"

Packaging	Product #	each	6 plus	50 plus
bag	95-1186 ....	\$16.20	\$13.50	\$10.50
clam	795-1186 ....	\$17.70	\$15.00	

**Diverter**  
**Price Pfister**



  
12 pt.  
B-6  
Index Button  
92-1186D  
Handle Screw  
72-0211  
1-1/4" x 2-1/16"

Packaging	Product #	each	6 plus
bag	95-1186D ....	\$8.10	\$6.75
clam	795-1186D ....	\$9.60	

**Pair of Handles**  
**Price Pfister**



  
12 pt.  
B-6  
Index Button  
92-2003  
Handle Screw  
72-0211  
1" x 2"

Packaging	Product #	each	6 plus
bag	95-0182 ....	\$12.60	\$10.50
clam	795-0182 ....	\$14.10	

HONEST MERCHANDISE-ETHICALLY REPRESENTED: KISSLER & CO. INC. established 1923 makes and distributes precision replacement parts of it's own manufacture and procurement. Brand names, model names, original manufacturers' name or stock numbers, which may appear on Seller's invoices, catalogs, packages, quotations or correspondence, are so utilized for identification purposes only; and are not a warranty or representation, either expressed or implied, that items offered or sold are genuine products of such original manufacturers

**Pair of Handles**

**Price Pfister**



**12 pt. B-6**

**Index Button**  
92-2003

**Handle Screw**  
72-0222

**1-1/2" x 2-7/8"**

Packaging	Product #	each	6 plus
bag	95-0183 ....	\$24.90	\$20.70

**Diverter**

**Price Pfister**



**12 pt. B-6**

**Index Button**  
92-2003D

**Handle Screw**  
72-0222

**1-1/2" x 2-7/8"**

Packaging	Product #	each	6 plus
bag	95-0183D ....	\$12.45	\$10.35

**Pair of Handles**

**Price Pfister**



**12 pt. B-6**

**Index Button**  
92-2127

**Handle Screw**  
72-0211

**7/8" x 1-5/8"**

Packaging	Product #	each	6 plus
bag	95-0180 ....	\$12.45	\$10.35

**Pair of Handles**

**Price Pfister**



**12 pt. B-6**

**Index Button**  
92-2127

**Handle Screw**  
72-0211

**1-1/4" x 2-1/4"**

Packaging	Product #	each	6 plus
bag	95-0181 ....	\$19.50	\$16.20
clam	795-0181 ....	\$22.50	

**Diverter**

**Price Pfister**



**12 pt. B-6**

**Index Button**  
92-2127D

**Handle Screw**  
72-0211

**1-1/4" x 2-1/4"**

Packaging	Product #	each	6 plus
bag	95-0181D ....	\$9.75	\$8.10

**Pair of Handles**

**Price Pfister**



**12 pt. B-6**

**Index Button**  
92-2127

**Handle Screw**  
72-0211

**15/16" x 1-7/8"**

Packaging	Product #	each	6 plus
bag	95-1180 ....	\$13.80	\$11.40
clam	795-1180 ....	\$15.30	\$12.90

**Pair of Handles**

**Price Pfister**



**12 pt. B-6**

**Index Button**  
92-2127

**Handle Screw**  
72-0211

**1-3/8" x 2-7/8"**

Packaging	Product #	each	6 plus	50 plus	100 plus
bag	95-1181 ....	\$16.20	\$13.50	\$10.50	\$9.45
clam	795-1181 ....	\$17.70	\$15.00		

**Diverter**

**Price Pfister**



**12 pt. B-6**

**Index Button**  
92-2127D

**Handle Screw**  
72-0211

**1-3/8" x 2-7/8"**

Packaging	Product #	each	6 plus
bag	95-1181D ....	\$8.10	\$6.75
clam	795-1181D ....	\$9.60	

**Pair of Handles (Mobile Home)**

**Price Pfister**



**12 pt. B-6**

**Index Button**  
92-5008

**Handle Screw**  
72-0212

**1 1/4" X 1 3/8"**

Packaging	Product #	each	6 plus
bag	95-2180 ....	\$11.40	\$9.45
clam	795-2180 ....	\$12.90	

**Pair of Handles**

**Sayco**



**16 pt. B-18**

**Index Button**  
92-5246

**Handle Screw**  
72-0122

**Long Broach**

**1-1/8" x 1-5/8"**

Packaging	Product #	each	6 plus
bag	95-0220 ....	\$13.50	\$11.40

**Pair of Handles**

**Sayco**



**16 pt. B-18**

**Index Button**  
92-5246

**Handle Screw**  
72-0112

**Short Broach**

**1-1/8" x 1-5/8"**

Packaging	Product #	each	6 plus
bag	95-1220 ....	\$13.50	\$11.40

**Diverter**

**Sayco**



**16 pt. B-18**

**Index Button**  
92-5246D

**Handle Screw**  
72-0112

**1-1/8" x 1-5/8"**

Packaging	Product #	each	6 plus
bag	95-1220D ....	\$6.75	\$5.70

HONEST MERCHANDISE-ETHICALLY REPRESENTED: KISSLER & CO. INC. established 1923 makes and distributes precision replacement parts of it's own manufacture and procurement. Brand names, model names, original manufacturers' name or stock numbers, which may appear on Seller's invoices, catalogs, packages, quotations or correspondence, are so utilized for identification purposes only: and are not a warranty or representation, either expressed or implied, that items offered or sold are genuine products of such original manufacturers

**Pair of Handles**

**Sayco**



16 pt.  
B-18

**Index Button**  
92-2112



**Handle Screw**  
72-0112

1-3/16" x 2-3/8"

Packaging	Product #	each	6 plus
bag	95-0225 ....	\$28.80	\$24.00

**Pair of Handles**

**Sayco**

16 pt.  
B-18

**Index Button**  
92-2112

**Handle Screw**  
72-0112

1-1/2" x 2-7/8"

Packaging	Product #	each	6 plus
bag	95-1225 ....	\$36.00	\$30.00

**Pair of Handles**

**Speakman**



20 pt.  
B-20

**Index Button**  
92-5250

**Handle Screw**  
72-0212

1-1/8" x 2"

Packaging	Product #	each	6 plus
bag	95-0195 ....	\$19.80	

**Pair of Handles**

**Speakman**



B-11

**Index Button**  
92-5250



**Handle Screw**  
72-0212

1-1/8" x 2"

Packaging	Product #	each
bag	95-3195 ....	\$21.60

**Pair of Handles OEM**

**SPEAKMAN®**

20 pt.  
B-20

**Index Button**  
92-2145D



**Handle Screw**  
72-0212

1-3/16" x 1-1/16"

Packaging	Product #	each
bag	95-0200 ....	\$78.00

**Diverter OEM**

**SPEAKMAN®**

20 pt.  
B-20

**Index Button**  
92-2145D



**Handle Screw**  
72-0212

1-3/16" x 1-1/16"

Packaging	Product #	each
bag	95-0200D ....	\$39.00

**Pair of Handles**

**Sterling**

16 pt.  
B-10

**Index Button**  
92-5224

**Handle Screw**  
72-0412

1" x 1-1/2"

Packaging	Product #	each	6 plus
bag	95-3231 ....	\$9.90	\$8.25

**Pair of Handles**

**Sterling**



16 pt.  
B-10

**Index Button**  
92-5235

**Handle Screw**  
72-0412

1-1/16" x 2-1/4"

Packaging	Product #	each	6 plus	50 plus
bag	95-0230 ....	\$16.20	\$13.50	\$10.80
clam	795-0230 ....	\$17.70		

**Diverter**

**Sterling**



16 pt.  
B-10

**Index Button**  
92-5009D

**Handle Screw**  
72-0412

1-1/16" x 2-1/4"

Packaging	Product #	each	6 plus
bag	95-0230D ....	\$8.10	\$6.75

**Most Common**

**Pair of Handles**

**Sterling**



B-43

**Index Button**  
92-5242

**Handle Screw**  
72-0422

1" x 2-1/8"

Packaging	Product #	each	6 plus
bag	95-0235 ....	\$11.70	\$9.75
clam	795-0235 ....	\$13.20	\$11.25

**Most Common**

**Pair of Handles**

**Sterling**



B-43

**Index Button**  
92-5242

**Handle Screw**  
72-0412

1-3/16" x 2-5/8"

Packaging	Product #	each	6 plus	50 plus
bag	95-1235 ....	\$25.20	\$21.00	\$16.50
clam	795-1235 ....	\$26.70	\$22.50	

**Diverter**

**Sterling**



B-43

**Index Button**  
92-5242D

**Handle Screw**  
72-0412

1-3/16" x 2-5/8"

Packaging	Product #	each	6 plus	50 plus
bag	95-1235D ....	\$12.60	\$10.50	\$8.25
clam	795-1235D ....	\$15.60		

HONEST MERCHANDISE-ETHICALLY REPRESENTED: KISSLER & CO. INC. established 1923 makes and distributes precision replacement parts of it's own manufacture and procurement. Brand names, model names, original manufacturers' name or stock numbers, which may appear on Seller's invoices, catalogs, packages, quotations or correspondence, are so utilized for identification purposes only: and are not a warranty or representation, either expressed or implied, that items offered or sold are genuine products of such original manufacturers

**Pair of Handles**

**Sterling**



**Index Button**  
92-5235

**Handle Screw**  
72-0412

**1-3/16" x 2-5/8"**

Packaging	Product #	each	6 plus
bag	95-1233 ....	\$24.90	\$20.70

**Pair of Handles**

**Sterling**



**Index Button**  
16 pt. B-10

**Handle Screw**  
72-0412

**1-3/16" x 2-3/4"**

Packaging	Product #	each	6 plus
bag	95-0234 ....	\$27.00	\$22.50

**Pair of Handles**

**Streamway**



**Index Button**  
17 pt. B-26

**Handle Screw**  
92-5224  
72-0112

**1-1/16" x 1-7/8"**

Packaging	Product #	each	6 plus	50 plus	100 plus
bag	95-0240 ....	\$15.00	\$12.45	\$9.90	\$9.00
clam	795-0240 ....	\$16.50	\$13.95		

**Pair of Handles**

**Streamway**



**Index Button**  
17 pt. B-26

**Handle Screw**  
92-5224  
72-0112

**1-3/8" x 2-1/4"**

Packaging	Product #	each	6 plus
bag	95-1240 ....	\$18.00	\$15.00

**Pair of Handles OEM**

**UNION BRASS**



**Index Button**  
17 pt. B-26

**Handle Screw**  
92-5250  
72-0232

**1-1/8" x 2-1/16"**

Packaging	Product #	each
bag	95-0250 ....	\$51.00

**Pair of Handles OEM**

**UNION BRASS**



**Index Button**  
17 pt. B-26

**Handle Screw**  
92-5250  
72-0262

**1-1/4" x 2-5/8"**

Packaging	Product #	each
bag	95-0252 ....	\$63.90

**Diverter OEM**

**UNION BRASS**



**Index Button**  
17 pt. B-26

**Handle Screw**  
92-5250D  
72-0262

**1-1/4" x 2-5/8"**

Packaging	Product #	each
bag	95-0252D ....	\$31.95

**Pair of Handles**

**Valley**



**Index Button**  
B-13

**Handle Screw**  
92-5231  
72-0214

**1-1/8" x 2"**

Packaging	Product #	each	6 plus	50 plus	100 plus
bag	95-7800 ....	\$12.60	\$10.50	\$8.25	\$7.50
clam	795-7800 ....	\$14.10	\$12.00		

**Diverter**

**Valley**



**Index Button**  
B-13

**Handle Screw**  
92-5210  
72-0214

**1-1/8" x 2"**

Packaging	Product #	each	6 plus	50 plus
bag	95-7800D ....	\$6.30	\$5.25	\$4.20

**Pair of Handles**

**Valley**



**Index Button**  
B-13

**Handle Screw**  
92-5231  
72-0214

**1-3/16" x 3-1/8"**

Packaging	Product #	each	6 plus	50 plus
bag	95-7815 ....	\$21.60	\$18.00	\$13.50
clam	795-7815 ....	\$23.70		

**Diverter**

**Valley**



**Index Button**  
B-13

**Handle Screw**  
92-5210  
72-0214

**1-3/16" x 3-1/8"**

Packaging	Product #	each	6 plus
bag	95-7815D ....	\$10.80	\$9.00
clam	795-7815D ....	\$13.80	

**Pair of Handles**

**Acme Brass**



**Index Button**  
16 pt. B-12

**Handle Screw**  
72-0211

**1-5/16" x 1-1/8"**

Packaging	Product #	each
bag	99-1125 ....	\$13.80

HONEST MERCHANDISE-ETHICALLY REPRESENTED: KISSLER & CO. INC. established 1923 makes and distributes precision replacement parts of it's own manufacture and procurement. Brand names, model names, original manufacturers' name or stock numbers, which may appear on Seller's invoices, catalogs, packages, quotations or correspondence, are so utilized for identification purposes only; and are not a warranty or representation, either expressed or implied, that items offered or sold are genuine products of such original manufacturers



**Diverter**  
**Acme Brass**



  
16 pt.  
B-12  
**Index Button**

**Handle Screw**  
72-0211  
**1-5/16" x 1-1/8"**

Packaging	Product #	each
bag	99-1125D....	\$6.90

**Pair of Handles**  
**American Brass**



  
17 pt.  
B-26  
**Index Button**

**Handle Screw**  
72-0111  
**1-9/16" x 15/16"**

Packaging	Product #	each	6 plus
bag	99-0122....	\$9.90	\$8.25
clam	799-0122....	\$12.90	

**Pair of Handles**  
**American Brass**



  
17 pt.  
B-26  
**Index Button**  
92-5008  
**Handle Screw**  
72-0111  
**1" x 1-9/16"**

Packaging	Product #	each	6 plus	50 plus
bag	99-0124....	\$16.20	\$13.50	\$10.50

**Pair of Handles**  
**American Brass**



  
17 pt.  
B-26  
**Index Button**  
92-5008  
**Handle Screw**  
72-0111  
**1-3/16" x 1-3/4"**

Packaging	Product #	each	6 plus	50 plus
bag	99-1124....	\$19.80	\$16.50	\$13.20

**Diverter**  
**American Brass**



  
17 pt.  
B-26  
**Index Button**  
92-5008D  
**Handle Screw**  
72-0111  
**1-3/16" x 1-3/4"**

Packaging	Product #	each	6 plus
bag	99-1124D....	\$9.90	\$8.25

**Pair of Handles**  
**American Standard**



  
16 pt.  
B-12  
**Index Button**

**Handle Screw**  
72-0111  
**1-1/4" x 1-3/16"**

Packaging	Product #	each	6 plus
bag	99-1041....	\$12.00	\$9.90

**Pair of Handles**  
**American Standard**



  
16 pt.  
B-12  
**Index Button**

**Handle Screw**  
72-0111  
**1-1/4" x 1-3/16"**

Packaging	Product #	each	6 plus
bag	99-0104....	\$12.00	\$9.90

**Pair of Handles**  
**American Standard**



  
16 pt.  
B-12  
**Index Button**

**Handle Screw**  
72-0111  
**1-1/16" x 1-3/16"**

Packaging	Product #	each	6 plus
bag	99-1104....	\$12.00	\$9.90

**Pair of Handles**  
**American Standard**



  
16 pt.  
B-12  
**Index Button**  
92-2003  
**Handle Screw**  
72-0212  
**1-1/16" x 1-1/4"**

Packaging	Product #	each	6 plus
bag	99-0106....	\$21.60	\$18.00

 **Pair of Handles**  
**American Standard**



  
16 pt.  
B-12  
**Index Button**

**Handle Screw**  
72-0111  
**1-5/16" x 1-1/8"**

Packaging	Product #	each	6 plus	50 plus	100 plus
bag	99-1103....	\$12.60	\$10.50	\$8.40	\$7.50
clam	799-1103....	\$14.10	\$12.00		

**Diverter**  
**American Standard**



  
16 pt.  
B-12  
**Index Button**

**Handle Screw**  
72-0111  
**1-5/16" x 1-1/8"**

Packaging	Product #	each	6 plus	50 plus	100 plus
bag	99-1103D....	\$6.30	\$5.25	\$4.20	\$3.75
clam	799-1103D....	\$7.80	\$6.75		

**Pair of Handles OEM**  
**American Standard**



  
16 pt.  
B-12

**Handle Screw**  
72-0211  
**1-3/4" x 1-1/4"**

Packaging	Product #	each
bag	99-0107....	\$48.00

HONEST MERCHANDISE-ETHICALLY REPRESENTED: KISSLER & CO. INC. established 1923 makes and distributes precision replacement parts of it's own manufacture and procurement. Brand names, model names, original manufacturers' name or stock numbers, which may appear on Seller's invoices, catalogs, packages, quotations or correspondence, are so utilized for identification purposes only; and are not a warranty or representation, either expressed or implied, that items offered or sold are genuine products of such original manufacturers



**Pair of Handles**  
American Standard



16 pt. B-12  
Index Button  
92-2003  
Handle Screw  
72-0111  
1-1/2" x 1-1/16"

Packaging	Product #	each	6 plus
bag	99-1107 ....	\$19.50	\$16.20
clam	799-1107 ....	\$22.50	

**Diverter**  
American Standard



16 pt. B-12  
Index Button  
92-2003D  
Handle Screw  
72-0111  
1-1/2" x 1-1/16"

Packaging	Product #	each	6 plus
bag	99-1107D ....	\$9.75	\$8.10

**Pair of Handles**  
American Standard



16 pt. B-12  
Index Button  
92-5228P  
Handle Screw  
72-0212  
7/8" x 1-3/4"

Packaging	Product #	each	6 plus
bag	99-1042 ....	\$17.40	\$14.40
clam	799-1042 ....	\$18.90	

**Pair of Handles**  
American Standard



16 pt. B-12  
Index Button  
92-5228P  
Handle Screw  
72-0212  
1" x 2-1/4"

Packaging	Product #	each	6 plus	50 plus
bag	99-1044 ....	\$21.60	\$18.00	\$14.40
clam	799-1044 ....	\$23.10	\$19.50	

**Diverter**  
American Standard



16 pt. B-12  
Index Button  
Handle Screw  
72-0212  
1" x 2-1/4"

Packaging	Product #	each	6 plus
bag	99-1044D ....	\$10.80	\$9.00

**Pair of Handles**  
American Standard



22 pt. B-8  
Index Button  
Handle Screw  
72-0221  
1-11/16" x 1-5/16"

Packaging	Product #	each	6 plus
bag	99-0105 ....	\$27.00	\$22.50
clam	799-0105 ....	\$28.50	\$24.00

**Pair of Handles**  
American Standard



22 pt. B-8  
Index Button  
Handle Screw  
72-0231  
1-7/8" x 1-5/8"

Packaging	Product #	each	6 plus
bag	99-1105 ....	\$38.40	\$31.80
clam	799-1105 ....	\$39.90	\$33.30

**Diverter**  
American Standard



22 pt. B-8  
Index Button  
Handle Screw  
72-0231  
1-7/8" x 1-5/8"

Packaging	Product #	each	6 plus
bag	99-1105D ....	\$19.20	\$15.90
clam	799-1105D ....	\$22.20	

**Pair of Handles (Service Sink)**  
American Standard



22 pt. B-8  
Index Button  
Handle Screw  
72-0231  
1-3/4" x 1-5/16"

Packaging	Product #	each
bag	99-2105 ....	\$90.00

**Pair of Handles (Die-Cast)**  
American Standard



22 pt. B-8  
Index Button  
92-2004  
Handle Screw  
72-0212  
15/16" x 1-9/16"

Packaging	Product #	each	6 plus
bag	99-0112 ....	\$16.20	\$13.50
clam	799-0112 ....	\$17.70	\$15.00

**Pair of Handles (Cast Brass)**  
American Standard



22 pt. B-8  
Index Button  
92-2004  
Handle Screw  
72-0222  
1-1/16" x 1-5/8"

Packaging	Product #	each	6 plus
bag	99-1102 ....	\$54.00	\$45.00
clam	799-1102 ....	\$55.50	\$46.50

**Diverter (Cast Brass)**  
American Standard



22 pt. B-8  
Index Button  
92-2004D  
Handle Screw  
72-0222  
1-1/16" x 1-5/8"

Packaging	Product #	each	6 plus
bag	99-1102D ....	\$27.00	\$22.50

HONEST MERCHANDISE-ETHICALLY REPRESENTED: KISSLER & CO. INC. established 1923 makes and distributes precision replacement parts of it's own manufacture and procurement. Brand names, model names, original manufacturers' name or stock numbers, which may appear on Seller's invoices, catalogs, packages, quotations or correspondence, are so utilized for identification purposes only; and are not a warranty or representation, either expressed or implied, that items offered or sold are genuine products of such original manufacturers



### Pair of Handles (Die-Cast)

American Standard



  
22 pt.  
B-8  
Index Button  
92-2004  
Handle Screw  
72-0222  
1-1/16" x 1-5/8"

Packaging	Product #	each	6 plus	50 plus
bag	99-1112....	\$22.50	\$18.60	\$15.00
clam	799-1112....	\$24.00	\$20.10	

### Diverter (Die-Cast)

American Standard



  
22 pt.  
B-8  
Index Button  
92-2004D  
Handle Screw  
72-0222  
1-1/16" x 1-5/8"

Packaging	Product #	each	6 plus
bag	99-1112D....	\$11.25	\$9.30
clam	799-1112D....	\$12.75	\$10.80

### Pair of Handles (Cast Brass)

American Standard



  
22 pt.  
B-8  
Index Button  
92-2004  
Handle Screw  
72-0232  
1-5/16" x 1-7/8"

Packaging	Product #	each	6 plus
bag	99-5102....	\$64.80	\$54.00
clam	799-5102....	\$66.30	\$55.50

### Diverter (Cast Brass)

American Standard



  
22 pt.  
B-8  
Index Button  
92-2004D  
Handle Screw  
72-0232  
1-5/16" x 1-7/8"

Packaging	Product #	each	6 plus
bag	99-5102D....	\$32.40	\$27.00
clam	799-5102D....	\$33.90	

### Pair of Handles

American Standard



  
22 pt.  
B-8  
Index Button  
Handle Screw  
72-0212  
1-11/16" x 1"

Packaging	Product #	each	6 plus
bag	99-0111....	\$28.80	\$24.00

### Pair of Handles

American Standard

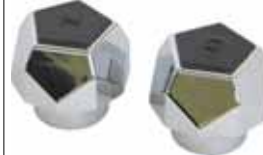

  
22 pt.  
B-8  
Index Button  
92-5113  
Handle Screw  
72-0212  
1-1/16" x 1-3/4"

Packaging	Product #	each	6 plus
bag	99-0108....	\$28.80	\$24.00

### Pair of Handles

American Standard



  
22 pt.  
B-8  
Index Button  
92-5114  
Handle Screw  
72-0232  
1-1/4" x 1-3/4"

Packaging	Product #	each	6 plus
bag	99-1108....	\$36.00	\$30.00

### Diverter

American Standard



  
22 pt.  
B-8  
Index Button  
92-5114D  
Handle Screw  
72-0232  
1-1/4" x 1-3/4"

Packaging	Product #	each	6 plus
bag	99-1108D....	\$18.00	\$15.00

### Pair of Handles

Briggs



  
18 pt.  
B-22  
Index Button  
Handle Screw  
72-0311  
1-5/8" x 7/8"

Packaging	Product #	each	6 plus
bag	99-0136....	\$10.80	\$9.00

### Pair of Handles OEM



  
18 pt.  
B-22  
Index Button  
92-2113  
Handle Screw  
72-0312  
2-1/4" x 1- 3/16"

Packaging	Product #	each
bag	99-0131....	\$69.30

### Pair of Handles

Briggs

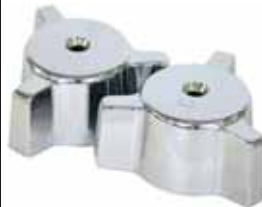

  
18 pt.  
B-22  
Index Button  
Handle Screw  
72-0311  
1" x 1-1/16"

Packaging	Product #	each	6 plus
bag	99-1134....	\$10.20	\$8.40

### Pair of Handles

Briggs



  
18 pt.  
B-22  
Index Button  
Handle Screw  
72-0311  
1-3/8" x 1-1/8"

Packaging	Product #	each	6 plus	50 plus
bag	99-0134....	\$13.50	\$11.10	\$8.70
clam	799-0134....	\$15.30	\$12.90	

HONEST MERCHANDISE-ETHICALLY REPRESENTED: KISSLER & CO. INC. established 1923 makes and distributes precision replacement parts of it's own manufacture and procurement. Brand names, model names, original manufacturers' name or stock numbers, which may appear on Seller's invoices, catalogs, packages, quotations or correspondence, are so utilized for identification purposes only: and are not a warranty or representation, either expressed or implied, that items offered or sold are genuine products of such original manufacturers

**Diverter**  
**Briggs**



  
18 pt.  
B-22  
Index Button

Handle Screw  
72-0311  
1-3/8" x 1-1/8"

Packaging	Product #	each	6 plus	50 plus
bag	99-0134D ....	\$6.90	\$5.70	\$4.50
clam	799-0134D ....	\$9.90		

**Pair of Handles** **OEM**



  
18 pt.  
B-22  
Index Button  
92-2118  
Handle Screw  
72-0312  
1-1/16" x 2-1/16"



Packaging	Product #	each
bag	99-1137 ....	\$45.00

**Pair of Handles**  
**Burlington Brass**



  
16 pt.  
B-12

Handle Screw  
72-0211  
1-5/8" x 7/8"

Packaging	Product #	each	6 plus
bag	99-1444 ....	\$10.80	

**Pair of Handles**  
**Burlington Brass**



  
16 pt.  
B-12

Handle Screw  
72-0211

Packaging	Product #	each	6 plus
bag	99-0143 ....	\$10.50	\$8.70

**Pair of Handles**  
**Burlington Brass**



  
16 pt.  
B-12

Handle Screw  
72-0211  
1-9/16" x 1-3/16"

Packaging	Product #	each	6 plus
bag	99-0144 ....	\$13.80	\$11.40

**Diverter**  
**Burlington Brass**



  
16 pt.  
B-12

Handle Screw  
72-0211  
1-9/16" x 1-3/16"

Packaging	Product #	each	6 plus
bag	99-0144D ....	\$6.90	\$5.70

**Pair of Handles**  
**Central Brass**



  
16 pt.  
B-12  
Index Button

Handle Screw  
72-0411  
1-3/4" x 1-1/8"

Packaging	Product #	each	6 plus	50 plus	100 plus
bag	99-1162 ....	\$8.10	\$6.75	\$5.25	
clam	799-1162 ....	\$9.60	\$8.25		

**Pair of Handles**  
**Central Brass**



  
16 pt.  
B-12  
Index Button

Handle Screw  
72-0411  
1-1/4" x 1-1/16"

Packaging	Product #	each	6 plus
bag	99-2164 ....	\$10.50	\$8.70

**Pair of Handles**  
**Central Brass**



  
16 pt.  
B-12  
Index Button

Handle Screw  
72-0411  
1-7/16" x 1-1/8"

**Most Common**

Packaging	Product #	each	6 plus	50 plus
bag	99-0164 ....	\$13.80	\$11.40	\$9.00
clam	799-0164 ....	\$15.30		

**Diverter**  
**Central Brass**





  
16 pt.  
B-12  
Index Button

Handle Screw  
72-0411  
1-7/16" x 1-1/8"

Packaging	Product #	each	6 plus
bag	99-0164D ....	\$6.90	\$5.70

**Pair of Handles**  
**Central Brass**



  
16 pt.  
B-12  
Index Button

Handle Screw  
72-0411  
1-5/16" x 1-1/8"

Packaging	Product #	each	6 plus
bag	99-0161 ....	\$12.00	\$9.90

**Diverter**  
**Central Brass**



  
16 pt.  
B-12

Handle Screw  
72-0411  
1-5/16" x 1-1/8"

Packaging	Product #	each	6 plus
bag	99-0161D ....	\$6.00	\$4.95

HONEST MERCHANDISE-ETHICALLY REPRESENTED: KISSLER & CO. INC. established 1923 makes and distributes precision replacement parts of it's own manufacture and procurement. Brand names, model names, original manufacturers' name or stock numbers, which may appear on Seller's invoices, catalogs, packages, quotations or correspondence, are so utilized for identification purposes only; and are not a warranty or representation, either expressed or implied, that items offered or sold are genuine products of such original manufacturers

**Pair of Handles**

**Central Brass**



  
16 pt.  
B-12  
Index Button

Handle Screw  
72-0411  
1-1/2" x 1-1/4"

Packaging	Product #	each	6 plus	50 plus	100 plus
bag	99-0163....	\$14.40	\$12.00	\$9.30	\$8.40
clam	799-0163....	\$15.90	\$13.50		

**Diverter**

**Central Brass**



  
16 pt.  
B-12  
Index Button

Handle Screw  
72-0411  
1-1/2" x 1-1/4"

Packaging	Product #	each	6 plus	50 plus
bag	99-0163D....	\$7.20	\$6.00	

**Most Common**

**Pair of Handles**

**Central Brass**



  
16 pt.  
B-12  
Index Button

Handle Screw  
72-0411  
1-3/8" x 2-3/8"

Packaging	Product #	each	6 plus	50 plus	100 plus
bag	99-1163....	\$14.40	\$12.00	\$9.30	\$8.40
clam	799-1163....	\$15.90	\$13.50		

**Most Common**

**Diverter**

**Central Brass**





  
16 pt.  
B-12  
Index Button

Handle Screw  
72-0411  
1-3/8" x 2-3/8"

Packaging	Product #	each	6 plus	50 plus
bag	99-1163D....	\$7.20	\$6.00	\$4.65
clam	799-1163D....	\$8.70	\$7.50	

**Pair of Handles OEM**



  
  
B-13

Packaging	Product #	each
bag	99-0006....	\$54.00

**Pair of Handles**

**Chicago**



  
B-25  
Index Button

Handle Screw  
72-0412  
1-1/4" x 1-13/16"

Packaging	Product #	each	6 plus
bag	99-0169....	\$25.20	\$21.00

**Pair of Handles OEM**

**CRANE PLUMBING**



  
12 pt.  
B-4

Handle Screw  
72-0112  
1-11/16" x 7/8"

Packaging	Product #	each
bag	99-0221....	\$24.00

**Pair of Handles OEM**

**CRANE PLUMBING**



  
12 pt.  
B-4

Handle Screw  
72-0111  
1-9/16" x 1-1/4"

Packaging	Product #	each
bag	99-0223....	\$54.00

**Pair of Handles**

**Crane-Recpal**



  
12 pt.  
B-4

Handle Screw  
72-0112  
1-3/4" x 1-3/4"

Packaging	Product #	each	6 plus
bag	99-0146....	\$25.20	\$21.00

**Pair of Handles**

**Crane-Recpal**



  
12 pt.  
B-4

Handle Screw  
72-0112

Packaging	Product #	each	6 plus
bag	99-0145....	\$25.20	\$21.00

**Pair of Handles**

**Crane-Recpal**



  
12 pt.  
B-6

Handle Screw  
72-0112  
2-1/2" x 2-1/2"

Packaging	Product #	each	6 plus
bag	99-1145....	\$34.20	\$28.50

**Diverter**

**Crane-Recpal**



  
12 pt.  
B-6

Handle Screw  
72-0112  
2-1/2" x 2-1/2"

Packaging	Product #	each	6 plus
bag	99-1145D....	\$17.10	\$14.25

HONEST MERCHANDISE-ETHICALLY REPRESENTED: KISSLER & CO. INC. established 1923 makes and distributes precision replacement parts of its own manufacture and procurement. Brand names, model names, original manufacturers' name or stock numbers, which may appear on Seller's invoices, catalogs, packages, quotations or correspondence, are so utilized for identification purposes only: and are not a warranty or representation, either expressed or implied, that items offered or sold are genuine products of such original manufacturers



**Diverter**  
**Crane-Repcal**



**B-7**

Handle Screw  
72-0112  
**13/16" x 1-1/8"**

Packaging	Product #	each
bag	99-2240D....	\$51.00

**Pair of Handles**  
**Crane-Repcal**



**12 pt. B-4**  
**Index Button**  
92-2117  
Handle Screw  
72-0112  
**13/16" x 1-1/4"**

Packaging	Product #	each	6 plus
bag	99-0147....	\$15.30	\$12.75

**Pair of Handles**  
**Crane-Repcal**



**12 pt. B-4**  
**Index Button**  
92-2117  
Handle Screw  
72-0112  
**1-1/16" x 1-5/8"**

Packaging	Product #	each	6 plus	50 plus
bag	99-2147....	\$20.70	\$17.25	

**Pair of Handles**  
**Crane-Repcal**



**12 pt. B-4**  
**Index Button**  
92-2117  
Handle Screw  
72-0112  
**1-3/16" x 1-7/8"**

Packaging	Product #	each	6 plus	50 plus
bag	99-1147....	\$25.20	\$21.00	

**Pair of Handles**  
**Crane-Repcal**



**12 pt. B-6**  
**Index Button**  
Handle Screw  
72-0112  
**1" x 1-1/16"**

Packaging	Product #	each	6 plus	50 plus
bag	99-2247....	\$13.50	\$11.25	\$9.00
clam	799-2247....	\$16.50		

**Most Common**  
**Pair of Handles**  
**Crane-Repcal**



**12 pt. B-6**  
**Index Button**  
Handle Screw  
72-0112  
**1-1/4" x 1-13/16"**

Packaging	Product #	each	6 plus	50 plus
bag	99-2245....	\$18.60	\$15.30	\$12.00
clam	799-2245....	\$20.10	\$16.80	

**Diverter**  
**Crane-Repcal**



**12 pt. B-6**  
**Index Button**  
Handle Screw  
72-0112  
**1-1/4" x 1-13/16"**

Packaging	Product #	each	6 plus	50 plus
bag	99-2245D....	\$9.30	\$7.65	\$6.00
clam	799-2245D....	\$10.80		

**Pair of Handles**  
**Crane-Repcal**



**12 pt. B-31**  
**Index Button**  
Handle Screw  
72-0112  
**1-1/4" x 1-13/16"**

Packaging	Product #	each	6 plus	50 plus
bag	99-2249....	\$21.60	\$18.00	\$13.50
clam	799-2249....	\$24.60		

**Pair of Handles**  
**Delta-Delex**



**B-13**  
Handle Screw  
72-0214

Packaging	Product #	each	6 plus
bag	99-1715....	\$12.60	\$10.50

**Pair of Handles OEM**



**B-13**  
**Index Button**  
Handle Screw

Packaging	Product #	each
bag	KRP6062....	\$33.60

**COMPARE TO OEM**  
**Pair of Handles**  
**Delta-Delex**



**B-13**  
**Index Button**  
92-5223  
Handle Screw  
72-0214  
**1-1/2" x 1-13/16"**

Packaging	Product #	each	6 plus
bag	99-2056....	\$12.60	\$10.50
clam	799-2056....	\$14.10	

**Pair of Handles**  
**Dick Brothers**



**16 pt. B-12**  
**Index Button**  
Handle Screw  
72-0211  
**1-5/8" x 7/8"**

Packaging	Product #	each	6 plus
bag	99-0431....	\$10.80	\$9.00

HONEST MERCHANDISE-ETHICALLY REPRESENTED: KISSLER & CO. INC. established 1923 makes and distributes precision replacement parts of it's own manufacture and procurement. Brand names, model names, original manufacturers' name or stock numbers, which may appear on Seller's invoices, catalogs, packages, quotations or correspondence, are so utilized for identification purposes only; and are not a warranty or representation, either expressed or implied, that items offered or sold are genuine products of such original manufacturers



**Pair of Handles**

**Dominion**





**B-13**

Handle Screw  
72-0211

Packaging	Product #	each	6 plus
bag	99-4105 ....	\$12.60	\$10.50

**Pair of Handles**

**Dominion**

**12 pt. B-6**

Packaging	Product #	each
bag	99-3390 ....	\$18.00

**Pair of Handles**

**Eljer**



**16 pt. B-12**

Index Button

Handle Screw  
72-0211

**1-3/16" x 1-1/16"**

Packaging	Product #	each	6 plus
bag	99-0142 ....	\$10.50	\$8.70
clam	799-0142 ....	\$13.50	

**Most Common**

**Pair of Handles**

**Eljer**



**16 pt. B-12**

Index Button

Handle Screw  
72-0211

**1-5/8" x 1-1/16"**

Packaging	Product #	each	6 plus	50 plus	100 plus
bag	99-1142 ....	\$13.80	\$11.40	\$9.00	\$7.95
clam	799-1142 ....	\$15.30	\$12.90		

**Most Common**

**Diverter**

**Eljer**



**16 pt. B-12**

Index Button

Handle Screw  
72-0211

**1-5/8" x 1-1/16"**

Packaging	Product #	each	6 plus	50 plus
bag	99-1142D ....	\$6.90	\$5.70	\$4.50
clam	799-1142D ....	\$8.40	\$7.20	

**Pair of Handles**

**Eljer**



**16 pt. B-12**

Index Button  
92-2149

Handle Screw  
72-0212

**1-3/16" x 2"**

Packaging	Product #	each	6 plus
bag	99-0443 ....	\$21.60	\$18.00
clam	799-0443 ....	\$23.10	\$19.50

**Diverter**

**Eljer**



**16 pt. B-12**

Index Button  
92-2149

Handle Screw  
72-0212

**1-3/16" x 2"**

Packaging	Product #	each	6 plus
bag	99-0443D ....	\$10.80	\$9.00

**Pair of Handles**

**Eljer**



**16 pt. B-12**

Index Button  
92-2003

Handle Screw  
72-0212

Packaging	Product #	each
bag	99-0440 ....	\$45.00

**Pair of Handles**

**Eljer**



**16 pt. B-12**

Index Button  
92-2003

Handle Screw  
72-0212

Packaging	Product #	each
bag	99-1440 ....	\$48.00

**Diverter**

**Eljer**



**16 pt. B-12**

Index Button  
92-2003

Handle Screw  
72-0212

Packaging	Product #	each
bag	99-1440D ....	\$24.00

**Most Common**

**Pair of Handles**

**Gerber**



**16 pt. B-18**

Index Button

Handle Screw  
72-0211

**1-5/8" x 1-1/8"**

Packaging	Product #	each	6 plus	50 plus
bag	99-0152 ....	\$8.10	\$6.75	\$5.40
clam	799-0152 ....	\$9.60	\$8.25	

**Most Common**

**Pair of Handles**

**Gerber**



**16 pt. B-18**

Index Button  
92-5009

Handle Screw  
72-0211

**1-5/16" x 1-1/2"**

Packaging	Product #	each	6 plus	50 plus	100 plus
bag	99-1152 ....	\$10.35	\$8.55	\$6.75	\$6.15
clam	799-1152 ....	\$11.85	\$10.05		

HONEST MERCHANDISE-ETHICALLY REPRESENTED: KISSLER & CO. INC. established 1923 makes and distributes precision replacement parts of it's own manufacture and procurement. Brand names, model names, original manufacturers' name or stock numbers, which may appear on Seller's invoices, catalogs, packages, quotations or correspondence, are so utilized for identification purposes only; and are not a warranty or representation, either expressed or implied, that items offered or sold are genuine products of such original manufacturers

**Handle OEM**

**GERBER.**



 16 pt. B-18  
Index Button

Handle Screw

1-5/16" x 1-1/2"

Packaging	Product #	each
bag	KGR94-404....	\$16.50

**Cold Handle OEM**

**GERBER.**



 16 pt. B-18

1-5/16" x 1-1/2"

Packaging	Product #	each
bag	KGR98-831....	\$20.10

**Hot Handle OEM**

**GERBER.**



 16 pt. B-18

1-5/16" x 1-1/2"

Packaging	Product #	each
bag	KGR98-830....	\$20.10

**Most Common**

**Pair of Handles**

**Gerber**



 16 pt. B-18  
Index Button

Handle Screw 72-0211

1-5/16" x 1"

Packaging	Product #	each	6 plus	50 plus	100 plus
bag	99-0151....	\$12.30	\$10.20	\$8.10	\$7.20
clam	799-0151....	\$13.80	\$11.70		

**Cold Handle OEM**

**GERBER.**



 16 pt. B-18

Handle Screw

1-5/16" x 1"

Packaging	Product #	each
bag	KGR90-401....	\$19.65

**Hot Handle OEM**

**GERBER.**



 16 pt. B-18

Handle Screw

1-5/16" x 1"

Packaging	Product #	each
bag	KGR90-400....	\$19.65

**Diverter**

**Gerber**



 16 pt. B-18  
Index Button

Handle Screw 72-0211

1-5/16" x 1"

Packaging	Product #	each	6 plus	50 plus
bag	99-0151D....	\$7.20	\$6.00	\$4.50
clam	799-0151D....	\$8.70		

**Most Common**

**Pair of Handles (long broach)**

**Gerber**



 16 pt. B-18  
Index Button 92-5009

Handle Screw 72-0211

1-3/16" x 2-1/2"

Packaging	Product #	each	6 plus	50 plus	100 plus
bag	99-1151....	\$14.40	\$12.00	\$9.30	\$8.40
clam	799-1151....	\$15.90	\$13.50		

**Pair of Handles Brushed Nickel**

**Gerber**



 16 pt. B-18  
Index Button 92-5009

Handle Screw 72-0211

Packaging	Product #	each
clam	799-1151BN....	\$28.80 \$24.00

**Handle OEM**

**GERBER.**



 16 pt. B-18  
Index Button

Handle Screw

1-3/16" x 2-1/2"

Packaging	Product #	each
bag	KGR94-402....	\$22.80

**Most Common**

**Diverter (long broach)**

**Gerber**



 16 pt. B-18  
Index Button 92-5009D

Handle Screw 72-0211

1-3/16" x 2-1/2"

Packaging	Product #	each	6 plus	50 plus	100 plus
bag	99-1151D....	\$7.20	\$6.00	\$4.65	\$4.20
clam	799-1151D....	\$8.70	\$7.50		

**Diverter Brushed Nickel**

**Gerber**



 16 pt. B-18  
Index Button 92-5009D

Handle Screw 72-0211

Packaging	Product #	each
clam	799-1151DBN....	\$14.40 \$12.00

HONEST MERCHANDISE-ETHICALLY REPRESENTED: KISSLER & CO. INC. established 1923 makes and distributes precision replacement parts of it's own manufacture and procurement. Brand names, model names, original manufacturers' name or stock numbers, which may appear on Seller's invoices, catalogs, packages, quotations or correspondence, are so utilized for identification purposes only; and are not a warranty or representation, either expressed or implied, that items offered or sold are genuine products of such original manufacturers

**Most Common**

**Pair of Handles (short broach)**

**Gerber**



**16 pt. 8-18**

**Index Button**  
92-5009

**Handle Screw**  
72-0211

**1-3/16" x 2-1/2"**

Packaging	Product #	each	6 plus	50 plus	100 plus
bag	99-1153 ....	\$14.40	\$12.00	\$9.30	\$8.40
clam	799-1153 ....	\$15.90	\$13.50		

**Pair of Handles Brushed Nickel**

**Gerber**



**16 pt. 8-18**

**Index Button**  
92-5009

**Handle Screw**  
72-0211

Packaging	Product #	each
clam	799-1153BN ....	\$28.80 \$24.00

**Handle OEM**

**GERBER.**



**16 pt. 8-18**

**Index Button**

**Handle Screw**

Packaging	Product #	each
bag	KGR94-401 ....	\$18.90

**Cold Handle OEM**

**GERBER.**



**16 pt. 8-18**

**Index Button**

**Handle Screw**

Packaging	Product #	each
bag	KGR98-827 ....	\$28.80

**Hot Handle OEM**

**GERBER.**



**16 pt. 8-18**

**Index Button**

**Handle Screw**

Packaging	Product #	each
bag	KGR98-826 ....	\$28.80

**Most Common**

**Diverter (short broach)**

**Gerber**



**16 pt. 8-18**

**Index Button**  
92-5009D

**Handle Screw**  
72-0211

**1-3/16" x 2-1/2"**

Packaging	Product #	each	6 plus	50 plus	100 plus
bag	99-1153D ....	\$7.20	\$6.00	\$4.65	\$4.20
clam	799-1153D ....	\$8.70	\$7.50		

**Diverter Handle OEM**

**GERBER.**



**16 pt. 8-18**

**Index Button**

**Handle Screw**

**1-3/16" x 2-1/2"**

Packaging	Product #	each
bag	KGR98-828 ....	\$28.80

**Diverter Brushed Nickel**

**Gerber**



**16 pt. 8-18**

**Index Button**  
92-5009D

**Handle Screw**  
72-0211

Packaging	Product #	each
clam	799-1153DBN ....	\$14.40 \$12.00

**Pair of Handles**

**Gerber**



**16 pt. 8-18**

**Index Button**  
92-5211

**Handle Screw**  
72-0211

**1-1/2"**

Packaging	Product #	each	6 plus
bag	99-0154 ....	\$27.00	\$22.50

**Pair of Handles (long broach)**

**Gerber**



**16 pt. 8-18**

**Index Button**  
92-5216

**Handle Screw**  
72-0211

**1-1/4" x 2-1/4"**

Packaging	Product #	each	6 plus
bag	99-1154 ....	\$18.90	\$15.60

**Diverter (long broach)**

**Gerber**



**16 pt. 8-18**

**Index Button**  
92-5216D

**Handle Screw**  
72-0211

**1-1/4" x 2-1/4"**

Packaging	Product #	each	6 plus
bag	99-1154D ....	\$9.45	\$7.80

**Pair of Handles (short broach)**

**Gerber**



**16 pt. 8-18**

**Index Button**  
92-5216

**Handle Screw**  
72-0211

**1-1/4" x 2-1/4"**

Packaging	Product #	each	6 plus
bag	99-1155 ....	\$18.90	\$15.60

HONEST MERCHANDISE-ETHICALLY REPRESENTED: KISSLER & CO. INC. established 1923 makes and distributes precision replacement parts of it's own manufacture and procurement. Brand names, model names, original manufacturers' name or stock numbers, which may appear on Seller's invoices, catalogs, packages, quotations or correspondence, are so utilized for identification purposes only; and are not a warranty or representation, either expressed or implied, that items offered or sold are genuine products of such original manufacturers

**Diverter (short broach)**

**Gerber**

16 pt.  
B-18

**Index Button**  
92-5216D

**Handle Screw**  
72-0211

1-1/4" x 2-1/4"

Packaging	Product #	each	6 plus
bag	99-1155D....	\$9.45	\$7.80

**Pair of Handles**

**Harcraft**

12 pt.  
B-31

**Index Button**  
92-2160

**Handle Screw**  
72-0212

7/8" x 1-3/4"

Packaging	Product #	each	6 plus
bag	99-0461....	\$18.75	\$15.60

**Pair of Handles**

**Harcraft**

12 pt.  
B-31

**Index Button**  
92-2161

**Handle Screw**  
72-0212

1-1/16" x 2-5/8"

Packaging	Product #	each	6 plus	50 plus
bag	99-1461....	\$32.40	\$27.00	\$21.60
clam	799-1461....	\$33.90	\$28.50	

**Diverter**

**Harcraft**

12 pt.  
B-31

**Index Button**  
92-2161D

**Handle Screw**  
72-0212

1-1/16" x 2-5/8"

Packaging	Product #	each	6 plus
bag	99-1461D....	\$16.20	\$13.50

**Pair of Handles**

**Indiana Brass**

18 pt.  
B-22

**Index Button**

**Handle Screw**  
72-0211

1-5/8" x 7/8"

Packaging	Product #	each	6 plus
bag	99-0171....	\$10.80	\$9.00

**Pair of Handles**

**Indiana Brass**

18 pt.  
B-22

**Handle Screw**  
72-0221

1-3/4" x 1-3/16"

Packaging	Product #	each	6 plus
bag	99-1171....	\$21.45	\$17.85

**Pair of Handles**

**Indiana Brass**

18 pt.  
B-22

**Index Button**

**Handle Screw**  
72-0211

1" x 7/8"

Packaging	Product #	each	6 plus
bag	99-0170....	\$11.55	\$9.60

**Pair of Handles**

**Indiana Brass**

18 pt.  
B-22

**Index Button**

**Handle Screw**  
72-0211

1-7/16" x 1-1/8"

Packaging	Product #	each	6 plus
bag	99-1170....	\$13.80	\$11.40
clam	799-1170....	\$15.30	\$12.90

**Diverter**

**Indiana Brass**

18 pt.  
B-22

**Index Button**

**Handle Screw**  
72-0211

1-7/16" x 1-1/8"

Packaging	Product #	each	6 plus
bag	99-1170D....	\$6.90	\$5.70
clam	799-1170D....	\$8.40	\$7.20

**Pair of Handles**

**Kohler**

16 pt.  
B-12

**Index Button**  
92-5226

**Handle Screw**  
72-0112

1-1/8" x 1-1/2"

Packaging	Product #	each	6 plus
bag	99-0182....	\$30.00	\$24.90

**Pair of Handles**

**Kohler**

16 pt.  
B-12

**Index Button**  
92-5226

**Handle Screw**  
72-0112

1" x 1-9/16"

Packaging	Product #	each	6 plus	50 plus
bag	99-0184....	\$18.00	\$15.00	\$12.75
clam	799-0184....	\$19.50	\$16.50	

**Pair of Handles**

**Kohler**

16 pt.  
B-12

**Index Button**  
92-5226

**Handle Screw**  
72-0112

1-5/16" x 2-1/8"

Packaging	Product #	each	6 plus	50 plus	100 plus
bag	99-1184....	\$24.00	\$19.50	\$17.70	\$16.20
clam	799-1184....	\$25.50	\$21.00		

HONEST MERCHANDISE-ETHICALLY REPRESENTED: KISSLER & CO. INC. established 1923 makes and distributes precision replacement parts of it's own manufacture and procurement. Brand names, model names, original manufacturers' name or stock numbers, which may appear on Seller's invoices, catalogs, packages, quotations or correspondence, are so utilized for identification purposes only; and are not a warranty or representation, either expressed or implied, that items offered or sold are genuine products of such original manufacturers



**Diverter**

**Kohler**



16 pt.  
B-12

**Index Button**  
92-5226D

**Handle Screw**  
72-0112

**1-5/16" x 2-1/8"**

Packaging	Product #	each	6 plus	50 plus
bag	99-1184D....	\$12.00	\$9.75	\$8.85
clam	799-1184D....	\$13.50		

**Pair of Handles**

**Kohler**



16 pt.  
B-12

**Handle Screw**  
72-0112

**1-11/16" x 2"**

Packaging	Product #	each	6 plus
bag	99-0187....	\$22.50	\$18.75

**Pair of Handles OEM**

**KOHLER**



19 pt.  
B-33



**Handle Screw**  
72-0112

**2-7/16" x 2"**

Packaging	Product #	each
bag	99-0192....	\$75.00

**Pair of Handles**

**Kohler**

19 pt.  
B-33



**Handle Screw**  
72-0111

**1-7/8" x 1-1/2"**

Packaging	Product #	each	6 plus
bag	99-0181....	\$28.80	\$24.00

**Pair of Handles**

**Kohler**

19 pt.  
B-33

**Handle Screw**  
72-0131

**2-5/8" x 2"**

Packaging	Product #	each	6 plus
bag	99-1181....	\$36.00	\$30.00
clam	799-1181....	\$37.50	

**Pair of Handles**

**Kohler**



19 pt.  
B-33

**Handle Screw**  
72-0111

**1-1/8" x 1-9/16"**

Packaging	Product #	each	6 plus
bag	99-1180....	\$39.60	\$33.00
clam	799-1180....	\$41.10	

**Diverter**

**Kohler**



19 pt.  
B-33



**Handle Screw**  
72-0111

**1-1/8" x 1-9/16"**

Packaging	Product #	each	6 plus
bag	99-1180D....	\$19.80	\$16.50

**Pair of Handles**

**Kohler**

19 pt.  
B-33

**Handle Screw**  
72-0131

**1-1/8" x 1-5/16"**

Packaging	Product #	each	6 plus
bag	99-0186....	\$32.40	\$27.00

**Pair of Handles**

**Kohler**



19 pt.  
B-33

**Handle Screw**  
72-0111

**1-3/8" x 1-5/8"**

Packaging	Product #	each	6 plus
bag	99-1186....	\$54.00	\$45.00
clam	799-1186....	\$55.50	

**Diverter**

**Kohler**



12 pt.  
B-24

**Handle Screw**  
72-0111

**1-3/8" x 1-5/8"**

Packaging	Product #	each	6 plus
bag	99-1186D....	\$27.00	\$22.50

**Pair of Handles**

**Michigan Brass**



12 pt.  
B-24

**Handle Screw**  
72-0121

**1-3/4" x 1-3/16"**

Packaging	Product #	each	6 plus	50 plus
bag	99-0191....	\$13.50	\$11.25	\$9.00

**Pair of Handles**

**Milwaukee**



16 pt.  
B-12

**Handle Screw**  
72-0121

**1-1/2" x 1-5/8"**

Packaging	Product #	each	6 plus
bag	99-0200....	\$24.00	\$19.95

HONEST MERCHANDISE-ETHICALLY REPRESENTED: KISSLER & CO. INC. established 1923 makes and distributes precision replacement parts of it's own manufacture and procurement. Brand names, model names, original manufacturers' name or stock numbers, which may appear on Seller's invoices, catalogs, packages, quotations or correspondence, are so utilized for identification purposes only: and are not a warranty or representation, either expressed or implied, that items offered or sold are genuine products of such original manufacturers



**Pair of Handles**

**Milwaukee**



12 pt. B-29

Handle Screw 72-0221  
2" x 1-3/16"

Packaging	Product #	each	6 plus
bag	99-0302....	\$24.00	\$19.95

**Pair of Handles**

**Milwaukee**



12 pt. B-29

Handle Screw 72-0221  
1-1/2" x 1-5/8"

Packaging	Product #	each	6 plus
bag	99-1300....	\$24.00	\$19.95

**Pair of Handles**

**Nibco**



17 pt. B-26

Handle Screw 72-0211  
1-3/4" x 1-1/8"

Packaging	Product #	each	6 plus
bag	99-0207....	\$9.90	\$8.25

**Pair of Handles**

**Nibco**



17 pt. B-26

Handle Screw 72-0211  
1-1/4" x 1-1/4"

Packaging	Product #	each	6 plus
bag	99-0209....	\$15.00	\$12.30

**Pair of Handles**

**Perlick**



12 pt. B-29

Handle Screw 72-0221  
2" x 1-3/16"

Packaging	Product #	each	6 plus
bag	99-0199....	\$24.00	\$19.95

**Pair of Handles**

**Price Pfister**



12 pt. B-6

Handle Screw 72-0211  
1-1/4" x 7/8"

Packaging	Product #	each	6 plus
bag	99-0212....	\$7.65	\$6.30

**Pair of Handles**

**Price Pfister**



12 pt. B-6

Handle Screw 72-0211  
1-1/2" x 15/16"

Packaging	Product #	each	6 plus
bag	99-0213....	\$7.65	\$6.30
clam	799-0213....	\$9.15	\$7.80

**Pair of Handles**

**Price Pfister**



12 pt. B-6

Handle Screw 72-0211  
1-3/4" x 1-3/16"

Packaging	Product #	each	6 plus
bag	99-1213....	\$9.45	\$7.80

**Pair of Handles**

**Price Pfister**



12 pt. B-6

Index Button 92-2129  
Handle Screw 72-0212  
1-3/16" x 5/8"

Packaging	Product #	each	6 plus
bag	99-0214....	\$18.00	\$15.00
clam	799-0214....	\$19.50	

**Diverter**

**Price Pfister**



12 pt. B-6

Index Button 92-2129D  
Handle Screw 72-0212  
1-1/2" x 3/4"

Packaging	Product #	each	6 plus	50 plus
bag	99-0214D....	\$7.65	\$6.30	\$4.95

**Pair of Handles**

**Price Pfister**



12 pt. B-6

Handle Screw 72-0211  
1" x 1-1/2"

Packaging	Product #	each	6 plus
bag	99-0210....	\$11.70	\$9.75
clam	799-0210....	\$13.20	

**Pair of Handles**

**Price Pfister**



12 pt. B-6

Handle Screw 72-0211  
1-1/4" x 2-3/8"

Packaging	Product #	each	6 plus	50 plus
bag	99-1210....	\$13.80	\$11.40	\$9.00
clam	799-1210....	\$15.30	\$12.90	

HONEST MERCHANDISE-ETHICALLY REPRESENTED: KISSLER & CO. INC. established 1923 makes and distributes precision replacement parts of it's own manufacture and procurement. Brand names, model names, original manufacturers' name or stock numbers, which may appear on Seller's invoices, catalogs, packages, quotations or correspondence, are so utilized for identification purposes only: and are not a warranty or representation, either expressed or implied, that items offered or sold are genuine products of such original manufacturers

**Most Common**

**Diverter**

**Price Pfister**



 12 pt. B-6

**Handle Screw**  
72-0211

**1-1/4" x 2-3/8"**

Packaging	Product #	each	6 plus	50 plus
bag	99-1210D....	\$6.90	\$5.70	\$4.50
clam	799-1210D....	\$8.40	\$7.20	

**Most Common**

**Pair of Handles**

**Price Pfister**



 12 pt. B-6

**Index Button**  
92-5008

**Handle Screw**  
72-0211

**7/8" x 1-5/8"**

Packaging	Product #	each	6 plus	50 plus
bag	99-0215....	\$6.90	\$6.30	\$4.95
clam	799-0215....	\$8.40	\$7.80	

**Most Common**

**Pair of Handles**

**Price Pfister**



 12 pt. B-6

**Index Button**  
92-5008

**Handle Screw**  
72-0211

**1-3/16" x 2-1/2"**

Packaging	Product #	each	6 plus	50 plus	100 plus
bag	99-1215....	\$12.60	\$10.50	\$8.40	\$7.80
clam	799-1215....	\$14.10	\$12.00		

**Pair of Handles Brushed Nickel**

**Price Pfister**



 12 pt. B-6

**Index Button**  
92-5008

**Handle Screw**  
72-0211

Packaging	Product #	each	6 plus
bag	799-1215BN....	\$25.20	\$21.00
clam	799-1215BN....		

**Most Common**

**Diverter**

**Price Pfister**



 12 pt. B-6

**Index Button**  
92-5008D

**Handle Screw**  
72-0211

**1-3/16" x 2-1/2"**

Packaging	Product #	each	6 plus	50 plus	100 plus
bag	99-1215D....	\$6.30	\$5.25	\$4.20	\$3.90
clam	799-1215D....	\$7.80	\$6.75		

**Diverter Brushed Nickel**

**Price Pfister**



 12 pt. B-6

**Index Button**  
92-5008D

**Handle Screw**  
72-0211

Packaging	Product #	each
clam	799-1215DBN....	\$12.60 \$10.50

**Pair of Handles**

**Price Pfister**



 12 pt. B-6

**Handle Screw**  
72-0211

**7/8" x 1-3/4"**

Packaging	Product #	each	6 plus
bag	99-0217....	\$14.85	\$12.30
clam	799-0217....	\$16.35	

**Pair of Handles**

**Price Pfister**



 12 pt. B-6

**Handle Screw**  
72-0211

**1-7/16" x 2-1/8"**

Packaging	Product #	each	6 plus	50 plus
bag	99-1217....	\$25.20	\$21.00	\$16.50
clam	799-1217....	\$26.70	\$22.50	

**Diverter**

**Price Pfister**



 12 pt. B-6

**Handle Screw**  
72-0211

**1-7/16" x 2-1/8"**

Packaging	Product #	each	6 plus
bag	99-1217D....	\$12.60	\$10.50

**Pair of Handles**

**Rhichmond Rheem**



 18 pt. B-22

**Handle Screw**  
72-0211

**1-5/8" x 7/8"**

Packaging	Product #	each	6 plus
bag	99-0230....	\$10.80	\$9.00

**Pair of Handles**

**Royal Brass**



 16 pt. B-12

**Handle Screw**  
72-0211

**1-5/8" x 7/8"**

Packaging	Product #	each	6 plus
bag	99-0228....	\$10.80	\$9.00

**Pair of Handles**

**Royal Brass**



 16 pt. B-12

**Handle Screw**  
72-0211

**1-7/16" x 1-1/8"**

Packaging	Product #	each	6 plus	50 plus
bag	99-0229....	\$13.80	\$11.40	\$9.00

HONEST MERCHANDISE-ETHICALLY REPRESENTED: KISSLER & CO. INC. established 1923 makes and distributes precision replacement parts of it's own manufacture and procurement. Brand names, model names, original manufacturers' name or stock numbers, which may appear on Seller's invoices, catalogs, packages, quotations or correspondence, are so utilized for identification purposes only: and are not a warranty or representation, either expressed or implied, that items offered or sold are genuine products of such original manufacturers

**Diverter**  
**Royal Brass**



16 pt.  
8-12

**Handle Screw**  
72-0211  
1-7/16" x 1-1/8"

Packaging	Product #	each	6 plus
bag	99-0229D....	\$6.90	\$5.70

**Most Common**

**Pair of Handles**  
**Savoy**



15 pt.  
8-14

**Handle Screw**  
72-0231  
1" x 1-9/6"

Packaging	Product #	each	6 plus	50 plus
bag	99-0232....	\$12.60	\$10.50	\$8.40
clam	799-0232....	\$14.10	\$12.00	

**Most Common**

**Diverter**  
**Savoy**



15 pt.  
8-14

**Handle Screw**  
72-0231  
1" x 1-9/6"

Packaging	Product #	each	6 plus	50 plus
bag	99-0232D....	\$6.30	\$5.25	\$4.20
clam	799-0232D....	\$7.80		

**Pair of Handles**  
**Savoy**



15 pt.  
8-14

**Handle Screw**  
72-0211  
1-3/8" x 1-3/16"

Packaging	Product #	each	6 plus
bag	99-0235....	\$10.80	\$9.00
clam	799-0235....	\$13.80	

**Pair of Handles**  
**Savoy**



16 pt.  
8-18

**Index Button**  
92-2112  
**Handle Screw**  
72-0112  
1-7/8" x 1-3/8"

Packaging	Product #	each	6 plus
bag	99-0240....	\$14.40	\$12.00

**Pair of Handles**  
**Savoy**



16 pt.  
8-18

**Index Button**  
92-2112  
**Handle Screw**  
72-0112  
2-1/8" x 1-5/8"

Packaging	Product #	each	6 plus
bag	99-1240....	\$16.20	\$13.50

**Diverter**  
**Sayco**



16 pt.  
8-18

**Index Button**  
92-2112D  
**Handle Screw**  
72-0112  
2-1/8" x 1-5/8"

Packaging	Product #	each	6 plus
bag	99-1240D....	\$8.10	\$6.75

**Pair of Handles**  
**Sayco**



16 pt.  
8-18

**Index Button**  
92-5246  
**Handle Screw**  
72-0112  
1-1/8" x 1"

Packaging	Product #	each	6 plus
bag	99-0242....	\$12.30	\$10.20

**Pair of Handles**  
**Sayco**



16 pt.  
8-18

**Index Button**  
92-5246  
**Handle Screw**  
72-0112  
1-3/8" x 1-3/8"

Packaging	Product #	each	6 plus	50 plus
bag	99-1242....	\$19.50	\$16.20	\$12.90

**Diverter**  
**Sayco**



16 pt.  
8-18

**Index Button**  
92-5246D  
**Handle Screw**  
72-0112  
1-3/8" x 1-3/8"

Packaging	Product #	each	6 plus
bag	99-1242D....	\$9.75	\$8.10

**Pair of Handles**  
**Sayco**



16 pt.  
8-18

**Index Button**  
92-5246  
**Handle Screw**  
72-0112  
1-1/8" x 1"

Packaging	Product #	each	6 plus	50 plus
bag	99-0244....	\$13.50	\$11.25	\$9.00

**Most Common**

**Pair of Handles**  
**Sayco**



16 pt.  
8-18

**Index Button**  
92-5246  
**Handle Screw**  
72-0112  
1-5/16" x 1-1/4"

Packaging	Product #	each	6 plus	50 plus
bag	99-1244....	\$19.80	\$16.50	\$13.20
clam	799-1244....	\$21.30	\$18.00	

HONEST MERCHANDISE-ETHICALLY REPRESENTED: KISSLER & CO. INC. established 1923 makes and distributes precision replacement parts of it's own manufacture and procurement. Brand names, model names, original manufacturers' name or stock numbers, which may appear on Seller's invoices, catalogs, packages, quotations or correspondence, are so utilized for identification purposes only; and are not a warranty or representation, either expressed or implied, that items offered or sold are genuine products of such original manufacturers

**Diverter**  
**Sayco**



  
16 pt.  
8-18  
**Index Button**  
92-5246D  
**Handle Screw**  
72-0112  
1-5/16" x 1-1/4"

Packaging	Product #	each	6 plus	50 plus
bag	99-1244D ....	\$9.90	\$8.25	\$6.60
clam	799-1244D ....	\$12.90		

**Pair of Handles**  
**Sayco**



  
16 pt.  
8-18  
**Index Button**  
92-5246  
**Handle Screw**  
72-0112  
1-1/4" x 1-5/8"

Packaging	Product #	each	6 plus	50 plus
bag	99-0245 ....	\$15.90	\$13.20	\$10.50
clam	799-0245 ....	\$17.40	\$14.70	

**Pair of Handles**  
**Sayco**



  
16 pt.  
8-18  
**Index Button**  
92-5246  
**Handle Screw**  
72-0112  
1-3/8" x 2-1/4"

Packaging	Product #	each	6 plus	50 plus	100 plus
bag	99-1245 ....	\$21.60	\$18.00	\$14.40	\$13.20
clam	799-1245 ....	\$23.10	\$19.50		

**Pair of Handles Brushed Nickel**  
**Sayco**



  
16 pt.  
8-18  
**Index Button**  
92-5246  
**Handle Screw**  
72-0112

Packaging	Product #	each
clam	799-1245BN ....	\$36.00 \$30.00

**Diverter**  
**Sayco**



  
16 pt.  
8-18  
**Index Button**  
92-5246D  
**Handle Screw**  
72-0112  
1-3/8" x 2-1/4"

Packaging	Product #	each	6 plus	50 plus
bag	99-1245D ....	\$10.80	\$9.00	\$7.20
clam	99-1245D ....	\$12.30	\$10.50	

**Diverter Brushed Nickel**  
**Sayco**



  
16 pt.  
8-18  
**Index Button**  
92-5246D  
**Handle Screw**  
72-0112

Packaging	Product #	each
clam	799-1245DBN ....	\$18.00 \$15.00

**Pair of Handles**  
**Speakman**



  
20 pt.  
8-20  
**Handle Screw**  
72-0221  
1-5/8" x 1-5/16"

Packaging	Product #	each	6 plus
bag	99-1262 ....	\$12.60	\$10.50
clam	799-1262 ....	\$14.10	

**Pair of Handles**  
**Speakman**



  
20 pt.  
8-20  
**Index Button**  
92-2003  
**Handle Screw**  
72-0212  
15/16" x 1-3/4"

Packaging	Product #	each	6 plus	50 plus
bag	99-1260 ....	\$16.20	\$13.50	\$10.80
clam	799-1260 ....	\$17.70		

**Diverter**  
**Speakman**



  
20 pt.  
8-20  
**Index Button**  
92-2003D  
**Handle Screw**  
72-0212  
15/16" x 1-3/4"

Packaging	Product #	each	6 plus
bag	99-1260D ....	\$8.10	\$6.75
clam	799-1260D ....	\$9.60	

**Pair of Handles**  
**Speakman**



  
8-11  
**Index Button**  
92-2003  
**Handle Screw**  
72-0112  
15/16" x 1-3/4"

Packaging	Product #	each	6 plus
bag	99-3260 ....	\$18.00	\$15.00
clam	799-3260 ....	\$19.50	

**Diverter**  
**Speakman**



  
8-11  
**Index Button**  
92-2003D  
**Handle Screw**  
72-0112  
15/16" x 1-3/4"

Packaging	Product #	each	6 plus
bag	99-3260D ....	\$9.00	\$7.50
clam	799-3260D ....	\$9.60	

**Pair of Handles**  
**Sterling**



  
16 pt.  
8-10  
**Handle Screw**  
72-0411  
1-1/4" x 1-1/4"

Packaging	Product #	each	6 plus	50 plus
bag	99-0280 ....	\$7.65	\$6.30	\$4.95
clam	799-0280 ....	\$9.15	\$7.80	

HONEST MERCHANDISE-ETHICALLY REPRESENTED: KISSLER & CO. INC. established 1923 makes and distributes precision replacement parts of it's own manufacture and procurement. Brand names, model names, original manufacturers' name or stock numbers, which may appear on Seller's invoices, catalogs, packages, quotations or correspondence, are so utilized for identification purposes only; and are not a warranty or representation, either expressed or implied, that items offered or sold are genuine products of such original manufacturers



**Pair of Handles**

**Sterling**



  
16 pt. B-16  
**Index Button**  
 92-5245  
**Handle Screw**  
 72-0412  
 1-1/8" x 1-1/2"

Packaging	Product #	each	6 plus
bag	99-1280....	\$14.40	\$12.00
clam	799-1280....	\$17.40	

**Pair of Handles**

**Sterling**



  
16 pt. B-16  
**Index Button**  
 92-5245  
**Handle Screw**  
 72-0412  
 1-1/8" x 1-1/2"

Packaging	Product #	each	6 plus
bag	99-3280....	\$14.40	\$12.00

**Most Common**

**Pair of Handles**

**Sterling**



  
16 pt. B-16  
**Handle Screw**  
 72-0411  
 1-5/16" x 1-1/4"

Packaging	Product #	each	6 plus	50 plus	100 plus
bag	99-0282....	\$9.75	\$8.10	\$6.30	\$5.70
clam	799-0282....	\$11.25	\$9.60		

**Most Common**

**Diverter**

**Sterling**



  
16 pt. B-16  
**Handle Screw**  
 72-0411  
 1-1/4" x 1-1/4"

Packaging	Product #	each	6 plus	50 plus	100 plus
bag	99-0282D....	\$4.80	\$3.90	\$3.00	\$2.70
clam	799-0282D....	\$6.30	\$5.40		

**Pair of Handles**

**Sterling**



  
16 pt. B-16  
**Index Button**  
 92-5245  
**Handle Screw**  
 72-0412  
 1-1/4" x 1-1/2"

Packaging	Product #	each	6 plus	50 plus
bag	99-1282....	\$13.20	\$10.80	\$8.70
clam	799-1282....	\$14.70	\$12.30	

**Diverter**

**Sterling**



  
16 pt. B-16  
**Index Button**  
**Handle Screw**  
 72-0412  
 1-1/4" x 1-1/2"

Packaging	Product #	each	6 plus	50 plus
bag	99-1282D....	\$6.60	\$5.40	\$4.35

**Most Common**

**Pair of Handles**

**Sterling**



  
16 pt. B-16  
**Index Button**  
 92-5242  
**Handle Screw**  
 72-0412  
 1-1/8" x 2-1/4"

Packaging	Product #	each	6 plus	50 plus
bag	99-1284....	\$25.20	\$21.00	\$16.50
clam	799-1284....	\$26.70	\$22.50	

**Diverter**

**Sterling**





  
16 pt. B-16  
**Index Button**  
**Handle Screw**  
 72-0412  
 1-1/8" x 2-1/4"

Packaging	Product #	each	6 plus	50 plus
bag	99-1284D....	\$12.60	\$10.50	\$8.25
clam	799-1284D....	\$15.30		

**Pair of Handles**

**Streamway**



  
17 pt. B-26  
**Handle Screw**  
 72-0111  
 1-5/8" x 7/8"

Packaging	Product #	each	6 plus	50 plus
bag	99-2270....	\$9.90	\$8.25	\$6.30
clam	799-2270....	\$11.40	\$9.75	

**Most Common**

**Pair of Handles**

**Streamway**



  
17 pt. B-26  
**Handle Screw**  
 72-0111  
 1-1/4" x 1-1/4"

Packaging	Product #	each	6 plus	50 plus
bag	99-0270....	\$16.20	\$13.50	\$10.80
clam	799-0270....	\$17.70	\$15.00	

**Diverter**

**Streamway**





  
17 pt. B-26  
**Handle Screw**  
 72-0111  
 1-1/4" x 1-1/4"

Packaging	Product #	each	6 plus	50 plus
bag	99-0270D....	\$8.10	\$6.75	\$5.40

**Pair of Handles**

**T & S**



  
20 pt. B-20  
**Handle Screw**  
 72-0411  
 1-3/16" x 2"

Packaging	Product #	each	6 plus
bag	99-2063....	\$24.00	\$21.00

HONEST MERCHANDISE-ETHICALLY REPRESENTED: KISSLER & CO. INC. established 1923 makes and distributes precision replacement parts of it's own manufacture and procurement. Brand names, model names, original manufacturers' name or stock numbers, which may appear on Seller's invoices, catalogs, packages, quotations or correspondence, are so utilized for identification purposes only; and are not a warranty or representation, either expressed or implied, that items offered or sold are genuine products of such original manufacturers



**Pair of Handles OEM**



**UNION BRASS**

18 pt. B-22

Handle Screw 72-0211  
5/8" x 7/8"

Packaging	Product #	each		
bag	99-0292....	\$23.40		

**Pair of Handles**

Union Brass



18 pt. B-22

Handle Screw 72-0211  
1-1/2" x 1"

Packaging	Product #	each	6 plus	
bag	99-0290....	\$12.60	\$10.50	
clam	799-0290....	\$10.50	\$9.00	

**Pair of Handles**

Union Brass



18 pt. B-22

Handle Screw 72-0221  
1-3/4" x 1-1/4"

Packaging	Product #	each	6 plus	
bag	99-1290....	\$14.40	\$12.00	
clam	799-1290....	\$15.90	\$13.50	

**Diverter**

Union Brass



B-13

Handle Screw 72-0221  
1-5/8" x 1-3/8"

Packaging	Product #	each	6 plus	
bag	99-0294D....	\$10.80	\$9.00	

**Diverter**

Union Brass



18 pt. B-22

Handle Screw 72-0221  
1-5/8" x 1-3/8"

Packaging	Product #	each	6 plus	
bag	99-1294D....	\$10.80	\$9.00	
clam	799-1294D....	\$16.80		

**Pair of Handles**

Union Brass



18 pt. B-22

Handle Screw 72-0221  
1-3/4" x 1-5/16"

Packaging	Product #	each	6 plus	
bag	99-1291....	\$10.80	\$9.00	

**Pair of Handles**

Union Brass



18 pt. B-22

Handle Screw 72-0231  
1-3/4" x 1-5/16"

Packaging	Product #	each	6 plus	
bag	99-0294....	\$21.60	\$18.00	

**Pair of Handles**

Union Brass



18 pt. B-22

Handle Screw 72-0421  
1-1/8" x 1"

Packaging	Product #	each	6 plus	
bag	99-0293....	\$11.55	\$9.60	

**Pair of Handles**

Union Brass



18 pt. B-22

Handle Screw 72-0431  
1-3/8" x 1-1/4"

Packaging	Product #	each	6 plus		50 plus
bag	99-1293....	\$15.90	\$13.20	\$10.50	
clam	799-1293....	\$17.40	\$14.70		

**Diverter**

Union Brass



B-13

Handle Screw 72-0431  
1-3/4" x 1-1/4"

Packaging	Product #	each	6 plus		50 plus
bag	99-1293D....	\$7.95	\$6.60	\$5.25	

**Pair of Handles**

Valley



B-13

Index Button 92-5231  
Handle Screw 72-0214  
1-1/8" x 1-1/2"

Packaging	Product #	each	6 plus	
bag	99-7804....	\$9.00	\$7.50	

**Pair of Handles**

Wolverine



12 pt. B-24

Handle Screw 72-0121  
1-3/4" x 1-3/16"

Packaging	Product #	each	6 plus	
bag	99-0350....	\$13.05	\$10.80	

HONEST MERCHANDISE-ETHICALLY REPRESENTED: KISSLER & CO. INC. established 1923 makes and distributes precision replacement parts of its own manufacture and procurement. Brand names, model names, original manufacturers' name or stock numbers, which may appear on Seller's invoices, catalogs, packages, quotations or correspondence, are so utilized for identification purposes only: and are not a warranty or representation, either expressed or implied, that items offered or sold are genuine products of such original manufacturers