

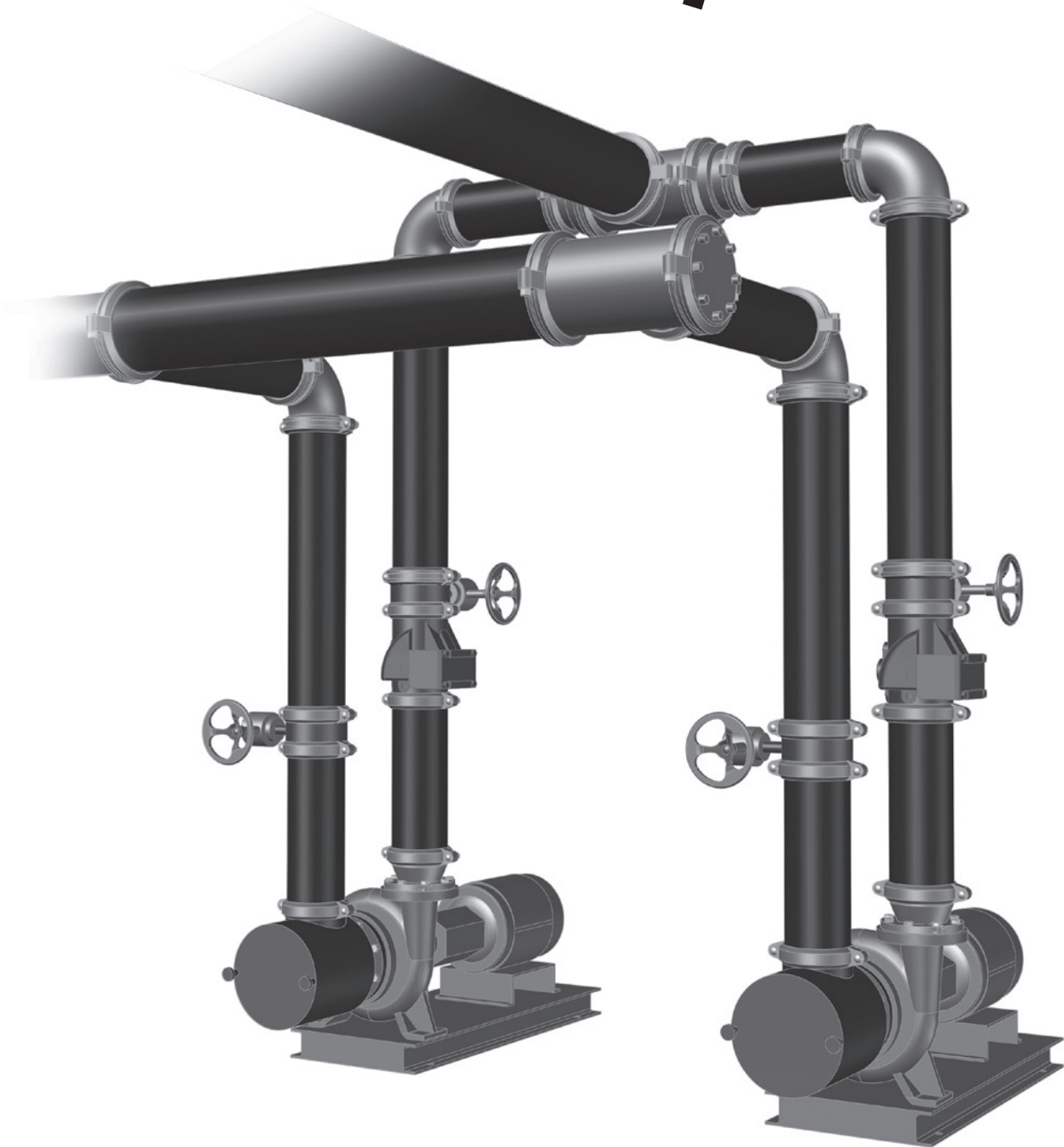

# Grinnell

## Mechanical Products



**U.S. List Prices**

Effective August 2015

**tyco**  
Mechanical Products

**IMPORTANT NOTICE**

Customer acknowledges and agrees that, in the absence of a previously executed agreement between the parties, products provided hereunder are provided pursuant to the TFPP General Terms and Conditions of Sale. **ATTENTION IS DIRECTED TO THE LIMITATION OF LIABILITY, WARRANTY, INDEMNITY AND OTHER CONDITIONS AVAILABLE AT:**

[http://www.tycofsbp.com/TFPPTerms\\_of\\_Sale/](http://www.tycofsbp.com/TFPPTerms_of_Sale/)

**Table of Contents**
**Section 1 – Introduction**

Table of Contents . . . . .	2-4
GRINNELL Gasket Styles, Grades and Recommendations . . . . .	5

**Section 2 – Couplings and Fittings**

#740 Rapid Installation Pivot-Bolt (GRIP) Rigid Coupling . . . . .	6
#772 Rigid Coupling . . . . .	7
#772 Rigid Coupling with Tri-Seal Gasket . . . . .	7
#772 Rigid Coupling with Grade "L" Silicone Gasket . . . . .	8
#772 Rigid Coupling with Grade "O" Fluoroelastomer Gasket . . . . .	8
#705 Flexible Coupling . . . . .	9
#705 Flexible Coupling with Tri-Seal Gasket . . . . .	9
#705 Flexible Coupling with Grade "L" Silicone Gasket . . . . .	10
#705 Flexible Coupling with Grade "O" Fluoroelastomer Gasket . . . . .	10
#707 Heavy-Duty Flexible Coupling . . . . .	11
#707 Heavy-Duty Flexible Coupling with Tri-Seal Gasket . . . . .	11
#707 Heavy-Duty Flexible Coupling with Grade "L" or Grade "O" Gasket . . . . .	12
#707L Large Diameter Heavy-Duty Flexible Coupling . . . . .	12
#716 Reducing Coupling . . . . .	13
#702 Outlet Coupling, Female Threaded End . . . . .	13
#702 Outlet Coupling, Male Threaded End . . . . .	14
#702 Outlet Coupling, Grooved End . . . . .	14
#770 High Pressure Rigid Coupling . . . . .	14
#780 Snap Coupling . . . . .	15
#71H Grooved Flange Adapter - Hinged . . . . .	15
#71 Grooved Flange Adapter . . . . .	16
#210 Grooved 90° Elbow . . . . .	16
#201 Grooved 45° Elbow . . . . .	16
#212 and #312 – Grooved 22½° Elbow . . . . .	17
#211 and #311 – Grooved 11¼° Elbow . . . . .	17
#210LR and #310LR – Grooved 90° Long Radius Elbow . . . . .	18
#201LR and #301LR – Grooved 45° Long Radius Elbow . . . . .	18
#310 - 3D, #310 - 5D, #310 - 6D Long Radius 90° Elbow, Painted . . . . .	19
#306 - 3D, #306 - 5D, #306 - 6D, Long Radius 60° Elbow, Painted . . . . .	19
#301 - 3D, #301 - 5D, #301 - 6D, Long Radius 45° Elbow, Painted . . . . .	20
#303 - 3D, #303 - 5D, #303 - 6D, Long Radius 30° Elbow, Painted . . . . .	20
#312 - 3D, #312 - 5D, #312 - 6D, Long Radius 22½° Elbow, Painted . . . . .	21
#311 - 3D, #311 - 5D, #311 - 6D, Long Radius 11¼° Elbow, Painted . . . . .	21
#316 Reducing Base Support Elbow, Groove x Flange . . . . .	22
#315 Groove x Male Thread – Adapter 90° Elbow . . . . .	22
#219 and #319 – Grooved Tee . . . . .	23
#320 Groove x Male Thread – Tee . . . . .	23
#221 and #321 – Grooved Reducing Tee . . . . .	24-25
#323 Groove x Male Thread – Reducing Tee with Threaded Branch . . . . .	25-26
#250 and #350 – Grooved Concentric Reducer . . . . .	27-28
#251 and #351 – Grooved Eccentric Reducer . . . . .	28-29
#372 Groove x Male Thread – Reducer . . . . .	30

*\*As used in this Table of Contents and Price Book, the designation "domestic" is meant to identify where the last point of manufacture or assembly takes place for a product. However, this designation does not represent compliance with any government regulatory standards or contract specifications and should not be relied upon for such purposes. You must request separate certifications or other representations concerning the specific regulatory standards or contract specifications which apply for your application.*

*In order to request regulatory or specification certifications/ representations please contact Tyco Trade Compliance at 215-362-0700 for assistance. In your request, please identify the part numbers and specific regulatory standards or contract specifications about which you are inquiring.*

See latest catalog or technical data sheets for specific approvals, listings, and design parameters.  
 POA = Price on availability. Prices subject to change without notice.

**Table of Contents**

**Section 2 – Couplings and Fittings (cont.)**

#391 Groove x Male Thread – Adapter Nipple . . . . .	30
#392 Groove x Groove – Adapter Nipple . . . . .	31
#393 Groove x Beveled – Adapter Nipple . . . . .	31
#395 Hose Adapter Nipple, Groove x Hose . . . . .	31
#380 Female Thread Adapter, Groove x Female Pipe Thread . . . . .	32
#314 Grooved Lateral . . . . .	32
#325 Grooved Reducing Lateral . . . . .	33
#324 Grooved Wye . . . . .	34
#331 Grooved Reducing Tee Wye . . . . .	34
#330 Grooved Tee Wye . . . . .	35
#327 – Grooved Cross . . . . .	36
#260 and #360 – Grooved Cap . . . . .	36
#260 Cast – Grooved Cap with 1/2", 3/4", or 1" Tap . . . . .	37
#341 Groove x Flange – Adapter 150# . . . . .	38
#342 Groove x Flange – Adapter 300# . . . . .	38
#397 Groove x Groove – Swaged Nipple . . . . .	39
#398 Groove x Male Thread – Swaged Nipple . . . . .	40
#399 Groove x Plain – Swaged Nipple . . . . .	41

**Section 3 – Mechanical Tees**

#730 Mechanical Tee – Threaded . . . . .	42
#730 Mechanical Tee – Grooved . . . . .	43
#730 Mechanical Cross – Threaded . . . . .	44
#730 Mechanical Cross – Grooved . . . . .	45

**Section 4 – Valves**

#B302 Grooved Butterfly Valve – EPDM or Nitrile . . . . .	46
#B302 Grooved Butterfly Valve – Fluoroelastomer . . . . .	46
#BN302 Grooved Butterfly Valve – EPDM NSF Approved . . . . .	47
#B302 and #BN302 Grooved Butterfly Valve – Accessories . . . . .	47
#B333 Grooved Butterfly Valve, EPDM or Nitrile, Gear Operator . . . . .	48
#B308 Grooved Butterfly Valve, EPDM or Nitrile, Gear Operator . . . . .	48
Babbitt Valve Chainwheels . . . . .	49
#B8101 Low Profile Butterfly Valve with Lever Handle . . . . .	50
#BV835 Grooved Ball Valve . . . . .	50
#B8200L Grooved Butterfly Valve – EPDM (For PVC Piping Systems) . . . . .	50
#590 Grooved Check Valve, EPDM or Nitrile . . . . .	51
#CV890 Grooved Dual Disk Check Valve, EPDM or Nitrile . . . . .	51
#TD830, Triple Duty Valve, Flow Control Type . . . . .	51

**Section 5 – Circuit Balancing Valves**

#CB800 Solder x Solder – Circuit Balancing Valve . . . . .	52
#CB800 Thread x Thread – Circuit Balancing Valve . . . . .	52
#CB800 Flange x Flange – Circuit Balancing Valve . . . . .	52
#CB800 Groove x Groove – Circuit Balancing Valve . . . . .	52
#CB800 Circuit Balancing Valves – Accessories . . . . .	53
Insulation Kits for #CB800 Circuit Balancing Valves . . . . .	53
Differential Measuring Computer . . . . .	53

**Table of Contents**

**Section 6 – Accessories**

#S853 Grooved Wye Strainer . . . . .	54
#S855 Grooved Tee – Type Strainer . . . . .	54
#S810 Groove x Flange ANSI – Suction Diffuser . . . . .	55
#7550 – Expansion Joint . . . . .	56 - 57

**Section 7 – Copper Systems**

#640 Pivot-Bolt Rigid Couplings Center-Stop Push-On Style Gasket . . . . .	58
#672 Rigid Couplings . . . . .	58
#616 Reducing Coupling . . . . .	58
#617 Transition Coupling for Joining IPS to Copper Tubing Systems . . . . .	59
#61H Flange Adapter – Hinged . . . . .	59
#61 Flange Adapter . . . . .	59
#610 Grooved 90° Elbow . . . . .	60
#601 Grooved 45° Elbow . . . . .	60
#619 Tee . . . . .	60
#660 Cap . . . . .	60
#650 Grooved Concentric Reducer . . . . .	61
#652 Grooved Reducer, Grooved x Cup . . . . .	61
#621 Reducing Tee, Grooved x Grooved x Grooved . . . . .	61
#618 Reducing Tee, Grooved x Grooved x Cup . . . . .	62
#407GG Dielectric Waterway Transition Fitting, Grooved x Grooved . . . . .	62
#407GT Dielectric Waterway, Grooved x Thread . . . . .	62
#407T Dielectric Waterway, Male Thread x Male Thread . . . . .	63
#B680 Copper System Butterfly Valve Grooved, EPDM . . . . .	63
Roll Groover Mini-Mite 2" – 8" Copper Tube #1039-66 . . . . .	63

**Section 8 – Stainless Steel Systems**

#472 Rigid Coupling 316 SS . . . . .	64
#472 Rigid Coupling 316 SS with Tri-seal Gasket . . . . .	64
#405 Flexible Coupling 316 SS . . . . .	65
#405 Flexible Coupling 316 SS with Tri-Seal Gasket . . . . .	65
#410 90° Elbow, <i>Schedule 10</i> . . . . .	66
#401 45° Elbow, <i>Schedule 10</i> . . . . .	66
#419 Tee, <i>Schedule 10</i> . . . . .	67
#460 Cap, <i>Schedule 10</i> . . . . .	67
#421 Reducing Tee, <i>Schedule 10</i> . . . . .	68
#441 Flange Adapter Nipple 150 lbs, <i>Schedule 10</i> . . . . .	68
#450 Concentric Reducer, <i>Schedule 10</i> . . . . .	69
#451 Eccentric Reducer, <i>Schedule 10</i> . . . . .	70
#410 90° Elbow, Long Radius, <i>Schedule 40</i> . . . . .	71
#401 45° Elbow, Long Radius, <i>Schedule 40</i> . . . . .	71
#419 Tee, <i>Schedule 40</i> . . . . .	72
#421 Reducing Tee, <i>Schedule 40</i> . . . . .	72
#450 Concentric Reducer, <i>Schedule 40</i> . . . . .	73
#451 Eccentric Reducer, <i>Schedule 40</i> . . . . .	74
#B480 Stainless Steel Grooved Butterfly Valve . . . . .	75
#BV435 Stainless Steel Grooved Ball Valve (600 psi) . . . . .	75

Introduction
Couplings & Fittings
Mechanical Tees
Valves
Circuit Balancing Valves
Accessories
Copper Systems
Stainless Steel Systems
Plain End Systems
Stainless Steel G-PRESS
HDPE Systems
Gaskets & Spare Parts
Preparation Equipment
Miscellaneous
Indices

\*As used in this Table of Contents and Price Book, the designation "domestic" is meant to identify where the last point of manufacture or assembly takes place for a product. However, this designation does not represent compliance with any government regulatory standards or contract specifications and should not be relied upon for such purposes. You must request separate certifications or other representations concerning the specific regulatory standards or contract specifications which apply for your application.

In order to request regulatory or specification certifications/ representations please contact Tyco Trade Compliance at 215-362-0700 for assistance. In your request, please identify the part numbers and specific regulatory standards or contract specifications about which you are inquiring.

**Customer Service: (800) 558-5236**

**www.grinnell.com**

See latest catalog or technical data sheets for specific approvals, listings, and design parameters.  
POA = Price on availability. Prices subject to change without notice.

**Table of Contents**
**Section 9 – Plain-End Systems**

#909 Plain End Coupling . . . . .	76
#910 Plain End 90° Elbow . . . . .	77
#910LR Plain End Long Radius 90° Elbow . . . . .	77
#901 Plain End 45° Elbow . . . . .	77
#901LR Plain End Long Radius 45° Elbow . . . . .	78
#919 Plain End Tee . . . . .	78
#927 Plain End Cross . . . . .	78
#924 Plain End True Wye . . . . .	79
#960 Plain End Cap (Bull Plug) . . . . .	79
#914 Plain End Lateral . . . . .	79
#999 Plain End Swaged Nipple . . . . .	80
#991 Adapter Nipple – Plain x Thread . . . . .	80
#992 Adapter Nipple – Plain x Grooved . . . . .	81
#993 Adapter Nipple – Plain x Bevel . . . . .	81
#941 Flange Adapter 150 lbs. . . . .	81
#942 Flange Adapter 300 lbs. . . . .	82
#921 Reducing Tee Plain End . . . . .	82

**Section 10 – Stainless Steel  
G-PRESS Systems**

#407 G-PRESS SS Coupling (Press x Press) . . . . .	83
#408 G-PRESS SS Slip Coupling (Press x Press) . . . . .	83
#468 G-PRESS SS 90° Elbow (Press x Press) . . . . .	83
#467 G-PRESS SS 90° Elbow (Press x Fitting) . . . . .	84
#471 G-PRESS SS 45° Elbow (Press x Press) . . . . .	84
#470 G-PRESS SS 45° Elbow (Press x Fitting) . . . . .	84
#442 G-PRESS SS Equal Tee (Press x Press x Press) . . . . .	85
#473 G-PRESS SS Reducing Tee (Press x Press x Press) . . . . .	85
#478 G-PRESS SS Reducing Tee Adapter (Press x Press x Female NPT) . . . . .	86
#474 G-PRESS SS Reducer (Fitting x Press) . . . . .	86
#476 G-PRESS SS Adapter (Press x Male NPT) . . . . .	87
#479 G-PRESS SS (Press x Female NPT) . . . . .	87
#484 G-PRESS SS End Cap (Press) . . . . .	88
#461 G-PRESS SS Weld Adaptor (Fitting x Weld) . . . . .	88
#477 G-PRESS SS Transition Nipple (Groove x Fitting) . . . . .	88
#485 G-PRESS SS Union (Press x Press) . . . . .	88
#475 G-PRESS SS Flange Adapter (Press x Flange) . . . . .	89
#466 G-PRESS SS Flange Adapter Van Stone (Press x Flange) . . . . .	89
#469 G-PRESS SS Ball Valve (Press x Press) . . . . .	89
G-PRESS SS O-Rings . . . . .	89

**Section 11 – HDPE Systems**

#9094 HDPE Flange Coupling . . . . .	90
#9095 HDPE Coupling . . . . .	90
#9097 HDPE Transition Coupling . . . . .	91

**Table of Contents**
**Section 12 – Gaskets & Spare Parts**

Replacement Gaskets – For 772, 770, 705, 707. . . . .	92
Replacement Tri-Seal Gaskets – For 772, 770, 705, 707 . . . . .	92
Replacement Grade “L” Silicone Gasket – For 772, 770, 705, 707 . . . . .	93
Replacement Grade “O” Fluoroelastomer Gasket – For 772, 770, 705, 707 . . . . .	93
Replacement Tri-Seal Gaskets Grade “O” Fluoroelastomer Gasket For #772, #770, #705, #707 . . . . .	94
Replacement Gaskets For # 716 Reducing Coupling . . . . .	95
Replacement Gaskets For #780 Snap Coupling . . . . .	95
#71H Hinged Flange Adapter Replacement Gaskets . . . . .	96
#71 Flange Adapter Replacement Gasket . . . . .	96
#71 Flange Washer Adapter, Carbon Steel or Stainless Steel . . . . .	96
Replacement Gaskets – For #730 . . . . .	97
Replacement Gaskets – For #702 Outlet Coupling . . . . .	98
Replacement Gaskets – For #740 Pivot-Bolt (GRIP) Rigid Coupling . . . . .	98
Replacement Gaskets – For #672 Coupling . . . . .	99
Replacement Gaskets – For #640 Coupling . . . . .	99
Replacement Gaskets – For #616 Reducing Coupling . . . . .	99
Replacement Gaskets – For #617 Transition Coupling . . . . .	100
Replacement Gaskets – For #61H Flange Adapter - Hinged . . . . .	100
Replacement Gaskets – For #61 Flange Adapter . . . . .	100
Phenolic Washer – For #61 Flange Adapter . . . . .	101
Replacement Gaskets – For #909 Plain End Coupling . . . . .	101
HDPE – #9094 Replacement Gaskets “E” . . . . .	102
HDPE – #9095 Replacement Gaskets “E” . . . . .	102
HDPE – #9097 Replacement Gaskets “E” . . . . .	102
Coupling Nut and Bolt Kit . . . . .	103
#71 Nut, Bolt, and Gasket Kit . . . . .	103
Pipe Tape Chrome Plated with GRINNELL Logo . . . . .	104
GRINNELL Gasket Lubricant . . . . .	104
GRINNELL Silicone Gasket Lubricant . . . . .	104

**Section 13 – Preparation Equipment**

Roll Grooving Machine Selection Chart . . . . .	105
Accessories . . . . .	105
Roll Selection Chart . . . . .	106

**Section 14 – Miscellaneous**

Grooved Couplings – Pieces Per Carton/Case . . . . .	107
Grooved Fittings – Pieces Per Carton/Case . . . . .	107
Grooved Fittings – Pieces Per Carton/Case . . . . .	108
Grooved Fittings – Pieces Per Carton/Case . . . . .	109
Copper System Grooved Couplings – Pieces Per Carton/Case . . . . .	109

**Section 15 – Indices**

Part Number Index . . . . .	110 – 124
Model Number Index . . . . .	125 – 127

\*As used in this Table of Contents and Price Book, the designation “domestic” is meant to identify where the last point of manufacture or assembly takes place for a product. However, this designation does not represent compliance with any government regulatory standards or contract specifications and should not be relied upon for such purposes. You must request separate certifications or other representations concerning the specific regulatory standards or contract specifications which apply for your application.

In order to request regulatory or specification certifications/ representations please contact Tyco Trade Compliance at 215-362-0700 for assistance. In your request, please identify the part numbers and specific regulatory standards or contract specifications about which you are inquiring.

See latest catalog or technical data sheets for specific approvals, listings, and design parameters.  
 POA = Price on availability. Prices subject to change without notice.

**GRINNELL Gasket Styles, Grades and Recommendations**

**Standard**

The standard style gasket, with a “C” shape configuration, is the most commonly used. It is provided as the standard gasket in the Figure 705, 707, 770, 772, 405, and 472 GRINNELL Couplings. The gasket is available in Grade “E” and “EN” EPDM Grade “T” Nitrile, Grade “L” Silicone, and Grade “O” Fluoroelastomer.



**Tri-Seal**

The tri-seal gasket is designed to close off the gap or gasket cavity. This is accomplished by positioning the center “rib” of the gasket over the gap between the pipes.



The tri-seal gasket has two tapered sealing edges in addition to the center rib for additional strength and sealing. The Tri-Seal gasket can be used with the Figure 705, 707, 770, 772, 405, 472, and 672 GRINNELL Couplings. The gasket is available in Grade “E”, “EN” EPDM and Grade “T” Nitrile.

**Note:** Rigid couplings are recommended for vacuum and low temperature applications

**Reducing Coupling**

The reducing gasket is provided with ribs used to position the larger pipe so that the sealing lip is located on the sealing surface of the pipe. This gasket is used only with the Figure 716 GRINNELL Reducing Coupling and is available in Grade “E” EPDM and Grade “T” Nitrile.



**Note:** Reducing couplings are not recommended for low temperature applications.

**Center-Stop Push-On**

The Grade “EHT” EPDM Center-Stop, Push-On Style Gasket is specially designed for easy installation of the GRINNELL Figure 640 Pivot-Bolt Coupling.



**Plain End Coupling**

This gasket is designed for use with the Figure 909 and Figure 9095 Plain End Coupling.



**Flange Adapter**

This gasket is specifically designed for use with the Figure 71 and 61 Flange Adapter. The gasket has an optimal amount of rubber to provide a dependable seal between both the pipe and mating surface. The gasket is available in Grade “E” EPDM and Grade “T” Nitrile.

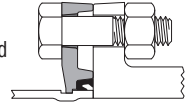

**Mechanical Tee, Cross and Strap**

The gasket provides a compression type seal, which is designed to conform to the exterior curve (OD) of the pipe.

This design is unique to both the Figure 730 Mechanical Tee (threaded and grooved) and Figure 40-5 Strap. The gasket is available in Grade “E” EPDM and Grade “T” Nitrile.

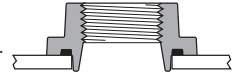

**Note:** When used in low temperature applications, use a petroleum-free silicone based lubricant, otherwise no lubricant is required on Mechanical Tee and Strap gaskets

**Outlet Coupling**

This gasket is specifically designed for use with the GRINNELL Figure 702 Outlet Coupling.

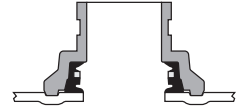

**GRINNELL Gaskets are designed exclusively for use with GRINNELL manufactured coupling housings. The mixing of other manufacturer’s gaskets or housings with GRINNELL Gaskets or Housings may result in pipe joint leakage or failure and will void the Tyco Mechanical Products limited warranty.**

The Gasket Recommendation Table has been developed to maximize service life. The table was developed from information supplied by the elastomer material manufacturers, reference technical literature, and testing conducted by Tyco Mechanical Products  
In evaluating the gasket grade for intended service, consider the following: system operating temperature, fluid or solution concentration, and duration of service.

All gasket recommendations are based on a temperature of 70°F (21°C) unless otherwise noted.  
When considering combinations of service solutions, consult Technical Services and Mechanical Services. (Phone 866-500-4768).  
Tyco Mechanical Products for recommendations for services not listed.  
Gasket recommendations apply to GRINNELL Gaskets and Valves only.

Grade	Temperature Range	Compound	Color Code	General Service Application
“E”	-30°F to 230°F (-34°C to 110°C)	EPDM	Green Striped	Hot water, dilute acids, alkalis, oil free air, and many chemical services not involving petroleum products. Excellent oxidation resistance. <b>NOT FOR USE WITH HYDROCARBONS.</b> <b>NOT RECOMMENDED FOR STEAM SERVICE</b>
“E” Tri-Seal	-30°F to 230°F (-34°C to 110°C)	EPDM	Green Striped	Hot water, dilute acids, alkalis, and many chemical services not involving petroleum products. Excellent oxidation resistance. <b>NOT FOR USE WITH HYDROCARBONS.</b> <b>Recommended for low temperature and vacuum services.</b>
“EN” and “EN” Tri-Seal IPS Pipe	Cold and Hot Potable Water up to 180°F (82°C)	EPDM	Green/Yellow Stripe	<b>IPS Sizes Only</b> , NSF 61 Approved for potable water. <b>NOT RECOMMENDED FOR HYDROCARBONS.</b>
“EN” Transition (IPS to CTS)	Cold and Hot Potable Water up to 180°F (82°C)	EPDM	Green/Copper Stripe	<b>Transition from IPS to CTS sizes only.</b> NSF 61 Approved for potable water.
“EN” Tri-Seal Copper Tubing	Cold and Hot Potable Water up to 180°F (82°C)	EPDM	Copper Striped	<b>CTS Sizes Only</b> , NSF 61 Approved for potable water. <b>NOT RECOMMENDED FOR HYDROCARBONS.</b>
“EHT” Center-Stop Push-On Style Copper Tubing	For closed-loop heating systems -30°F to 250°F (-34°C to 120°C) Potable Water up to 180°F (82°C)	EPDM	Red and Copper Striped	<b>CTS Sizes Only</b> , NSF 61 Approved for potable water. Recommended for use in low temperature and vacuum systems <b>NOT RECOMMENDED FOR HYDROCARBONS.</b>
“T” and “T” Tri-Seal	-20°F to 180°F (-29°C to 82°C)	Nitrile	Orange Striped	Petroleum products, vegetable oils, mineral oils and air with oils. High-End oil vapor temperature, decrease to 150°F (66°C) <b>Not Recommended for Hot Water Systems.</b> <b>Not Recommended for Hot Dry Air Systems</b>
“O”	+20°F to 300°F (-7°C to 149°C)	Fluoroelastomer	Blue Striped	Oxidizing acids, petroleum products, hydraulic fluids, lubricants, halogenated hydrocarbons.
“L”	-30°F to 350°F (-34°C to 177°C)	Silicone *	Red Gasket	Air without hydrocarbons, dry heat.

\* To prevent gasket from deteriorating, NEVER use silicone-based lubricants with Grade “L” Silicone gaskets

Introduction  
Couplings & Fittings  
Mechanical Tees  
Valves  
Circuit Balancing Valves  
Accessories  
Copper Systems  
Stainless Steel Systems  
Plain End Systems  
Stainless Steel G-PRESS  
HDPE Systems  
Gaskets & Spare Parts  
Preparation Equipment  
Miscellaneous  
Indices

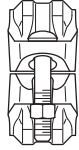
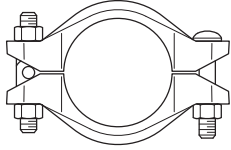
**#740 Rapid Installation Pivot-Bolt (GRIP) Rigid Coupling  
 with Grade “EHT” EPDM or Grade “T” Nitrile Center-Stop Push-On Style Gasket**

Nominal Size	Painted			Galvanized		
	Grade “EHT” EPDM	Grade “T” Nitrile	List Price	Grade “EHT” EPDM	Grade “T” Nitrile	List Price
2"	74020EHT	74020TS	\$72.00	74020EGHT	74020TGS	\$91.00
2½"	74025EHT	74025TS	\$82.50	74025EGHT	74025TGS	\$103.50
3"	74030EHT	74030TS	\$94.50	74030EGHT	74030TGS	\$121.00
4"	74040EHT	74040TS	\$132.50	74040EGHT	74040TGS	\$171.00
5"	74050EHT	74050TS	\$171.00	74050EGHT	74050TGS	\$222.50
6"	74060EHT	74060TS	\$224.50	74060EGHT	74060TGS	\$291.50
8"	74080EHT	74080TS	\$354.00	74080EGHT	74080TGS	\$460.50

**Technical Data Sheet: G144**

All standard couplings can be provided with stainless steel nuts and bolts upon request.  
 See latest catalog or technical data sheets for specific approvals, listings, and design parameters.  
 POA = Price on availability. Prices subject to change without notice.

# Tyco Mechanical Products

## Section 2 – Couplings & Fittings



### #772 Rigid Coupling with Grade “E” EPDM or Grade “T” Nitrile Gasket

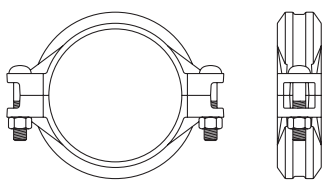

Nominal Size	Painted			Galvanized		
	Grade “E” EPDM	Grade “T” Nitrile	List Price	Grade “E” EPDM	Grade “T” Nitrile	List Price
1 1/4"	77213ES	77213TS	\$61.50	77213EGS	77213TGS	\$77.50
1 1/2"	77215ES	77215TS	\$66.00	77215EGS	77215TGS	\$83.00
2"	77220ES	77220TS	\$72.00	77220EGS	77220TGS	\$91.00
2 1/2"	77225ES	77225TS	\$82.50	77225EGS	77225TGS	\$103.50
3"	77230ES	77230TS	\$94.50	77230EGS	77230TGS	\$121.00
4"	77240ES	77240TS	\$132.50	77240EGS	77240TGS	\$171.00
5"	77250ES	77250TS	\$171.00	77250EGS	77250TGS	\$222.50
6"	77260ES	77260TS	\$224.50	77260EGS	77260TGS	\$291.50
8"	77280ES	77280TS	\$354.00	77280EGS	77280TGS	\$460.50
10"	77210ES	77210TS	\$687.00	77210EGS	77210TGS	\$916.50
12"	77212ES	77212TS	\$767.50	77212EGS	77212TGS	\$1,028.00
14"	77214ES	77214TS	\$727.50	77214EGS	77214TGS	\$933.50
16"	77216ES	77216TS	\$891.00	77216EGS	77216TGS	\$1,137.00
18"	77218ES	77218TS	\$1,029.50	77218EGS	77218TGS	\$1,333.50
20"	77221ES	77221TS	\$1,407.00	77221EGS	77221TGS	\$1,763.00
24"	77224ES	77224TS	\$1,803.50	77224EGS	77224TGS	\$2,284.50

Technical Data Sheet: G141

### #772 Rigid Coupling with Grade “E” EPDM or Grade “T” Nitrile Tri-Seal Gasket

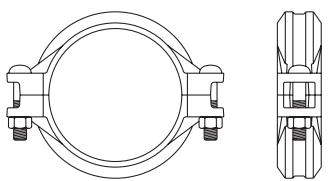

Nominal Size	Painted			Galvanized		
	Grade “E” EPDM	Grade “T” Nitrile	List Price	Grade “E” EPDM	Grade “T” Nitrile	List Price
1 1/4"	77213E3S	77213T3S	\$87.50	77213E3GS	77213T3GS	\$104.00
1 1/2"	77215E3S	77215T3S	\$93.50	77215E3GS	77215T3GS	\$111.00
2"	77220E3S	77220T3S	\$110.00	77220E3GS	77220T3GS	\$132.00
2 1/2"	77225E3S	77225T3S	\$132.50	77225E3GS	77225T3GS	\$155.00
3"	77230E3S	77230T3S	\$140.00	77230E3GS	77230T3GS	\$171.50
4"	77240E3S	77240T3S	\$195.50	77240E3GS	77240T3GS	\$241.00
5"	77250E3S	77250T3S	\$309.00	77250E3GS	77250T3GS	\$544.50
6"	77260E3S	77260T3S	\$364.50	77260E3GS	77260T3GS	\$446.00
8"	77280E3S	77280T3S	\$481.50	77280E3GS	77280T3GS	\$602.50
10"	77210E3S	77210T3S	\$964.50	77210E3GS	77210T3GS	\$1,224.50
12"	77212E3S	77212T3S	\$1,096.50	77212E3GS	77212T3GS	\$1,409.50
14"	77214E3S	77214T3S	\$727.50	77214E3GS	77214T3GS	\$933.50
16"	77216E3S	77216T3S	\$891.00	77216E3GS	77216T3GS	\$1,137.00
18"	77218E3S	77218T3S	\$1,029.50	77218E3GS	77218T3GS	\$1,333.50
20"	77221E3S	77221T3S	\$1,407.00	77221E3GS	77221T3GS	\$1,763.00
24"	77224E3S	77224T3S	\$1,803.50	77224E3GS	77224T3GS	\$2,284.50

Orders for items in shaded areas **cannot** be cancelled or returned.

Technical Data Sheet: G141

Introduction  
Couplings & Fittings  
Mechanical Tees  
Valves  
Circuit Balancing Valves  
Accessories  
Copper Systems  
Stainless Steel Systems  
Plain End Systems  
Stainless Steel G-PRESS  
HDPE Systems  
Gaskets & Spare Parts  
Preparation Equipment  
Miscellaneous  
Indices

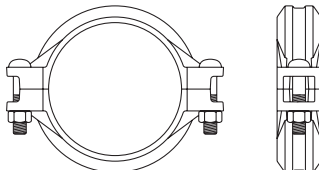
**#772 Rigid Coupling  
 with Grade “L” Silicone Gasket**

<i>Nominal Size</i>	<i>Painted</i>	<i>List Price</i>	<i>Galvanized</i>	<i>List Price</i>
1¼"	77213LS	\$142.00	77213LGS	\$157.00
1½"	77215LS	\$203.00	77215LGS	\$219.00
2"	77220HLS	\$160.00	77220HLGS	\$180.00
2½"	77225HLS	\$182.00	77225HLGS	\$207.00
3"	77230HLS	\$204.50	77230HLGS	\$234.00
4"	77240HLS	\$303.50	77240HLGS	\$347.00
5"	77250LS	\$546.00	77250LGS	\$602.00
6"	77260LS	\$641.50	77260LGS	\$713.50
8"	77280LS	\$802.00	77280LGS	\$916.50
10"	77210LS	\$1,452.00	77210LGS	\$1,720.00
12"	77212LS	\$1,666.50	77212LGS	\$1,970.50
14"	77214LS	\$1,716.00	77214LGS	\$1,909.50
16"	77216LS	\$1,888.00	77216LGS	\$2,133.50

 Orders for items in shaded areas *cannot* be cancelled or returned.

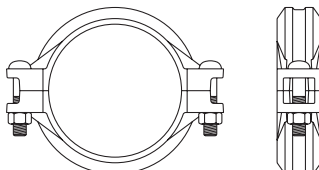
**Technical Data Sheet: G141**
**#772 Rigid Coupling  
 with Grade “O” Fluoroelastomer Gasket**

<i>Nominal Size</i>	<i>Painted</i>	<i>List Price</i>	<i>Galvanized</i>	<i>List Price</i>
1¼"	772130S	\$432.00	772130GS	\$449.00
1½"	772150S	\$431.50	772150GS	\$448.50
2"	77220HOS	\$410.50	77220HOGS	\$430.50
2½"	77225HOS	\$462.00	77225HOGS	\$485.00
3"	77230HOS	\$516.00	77230HOGS	\$546.00
4"	77240HOS	\$844.50	77240HOGS	\$887.00
5"	772500S	\$920.00	772500GS	\$977.00
6"	772600S	\$1,156.50	772600GS	\$1,229.50
8"	772800S	\$1,404.50	772800GS	\$1,519.00
10"	772100S	\$2,382.50	772100GS	\$2,649.50
12"	772120S	\$3,298.50	772120GS	\$3,602.00
14"	772140S	POA	772140GS	POA
16"	772160S	POA	772160GS	POA
18"	772180S	POA	772180GS	POA
20"	772210S	POA	772210GS	POA
24"	772240S	POA	772240GS	POA

 Orders for items in shaded areas *cannot* be cancelled or returned.

**Technical Data Sheet: G141**

All standard couplings can be provided with stainless steel nuts and bolts upon request.  
 See latest catalog or technical data sheets for specific approvals, listings, and design parameters.  
 POA = Price on availability. Prices subject to change without notice.



## Tyco Mechanical Products Section 2 – Couplings & Fittings

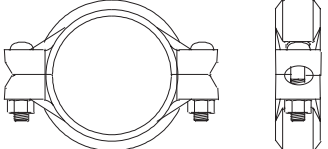

### #705 Flexible Coupling with Grade "E" EPDM or Grade "T" Nitrile Gasket

	Nominal Size	Painted			Galvanized		
		Grade "E" EPDM	Grade "T" Nitrile	List Price	Grade "E" EPDM	Grade "T" Nitrile	List Price
		1 1/4"	70513ES	70513TS	\$49.00	70513EGS	70513TGS
1 1/2"	70515ES	70515TS	\$59.50	70515EGS	70515TGS	\$74.00	
2"	70520ES	70520TS	\$72.50	70520EGS	70520TGS	\$95.00	
2 1/2"	70525ES	70525TS	\$84.00	70525EGS	70525TGS	\$117.50	
3"	70530ES	70530TS	\$93.50	70530EGS	70530TGS	\$129.00	
4"	70540ES	70540TS	\$134.50	70540EGS	70540TGS	\$189.50	
5"	70550ES	70550TS	\$203.00	70550EGS	70550TGS	\$291.50	
6"	70560ES	70560TS	\$240.50	70560EGS	70560TGS	\$344.00	
8"	70580ES	70580TS	\$390.00	70580EGS	70580TGS	\$579.50	
10"	70510ES	70510TS	\$635.00	70510EGS	70510TGS	\$909.50	
12"	70512ES	70512TS	\$722.00	70512EGS	70512TGS	\$1,033.00	

Orders for items in shaded areas **cannot** be cancelled or returned.

\* Items subject to minimum order quantities.

**Technical Data Sheet: G110**

### #705 Flexible Coupling with Grade "E" EPDM or Grade "T" Nitrile Tri-Seal Gasket

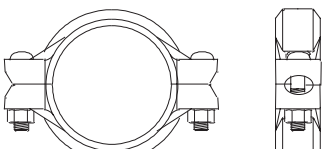
	Nominal Size	Painted			Galvanized		
		Grade "E" EPDM	Grade "T" Nitrile	List Price	Grade "E" EPDM	Grade "T" Nitrile	List Price
		1 1/4"	70513E3S	70513T3S	\$79.50	70513E3GS	70513T3GS
1 1/2"	70515E3S	70515T3S	\$86.50	70515E3GS	70515T3GS	\$103.50	
2"	70520E3S	70520T3S	\$89.50	70520E3GS	70520T3GS	\$107.00	
2 1/2"	70525E3S	70525T3S	\$107.00	70525E3GS	70525T3GS	\$125.50	
3"	70530E3S	70530T3S	\$112.50	70530E3GS	70530T3GS	\$135.50	
4"	70540E3S	70540T3S	\$160.50	70540E3GS	70540T3GS	\$196.50	
5"	70550E3S	70550T3S	\$273.00	70550E3GS	70550T3GS	\$325.00	
6"	70560E3S	70560T3S	\$301.50	70560E3GS	70560T3GS	\$366.00	
8"	70580E3S	70580T3S	\$501.00	70580E3GS	70580T3GS	\$600.50	
10"	70510E3S	70510T3S	\$753.50	70510E3GS	70510T3GS	\$1,012.50	
12"	70512E3S	70512T3S	\$884.50	70512E3GS	70512T3GS	\$1,164.50	

Orders for items in shaded areas **cannot** be cancelled or returned.

**Technical Data Sheet: G110**

Introduction  
Couplings & Fittings  
Mechanical Tees  
Valves  
Circuit Balancing Valves  
Accessories  
Copper Systems  
Stainless Steel Systems  
Plain End Systems  
Stainless Steel G-PRESS  
HDPE Systems  
Gaskets & Spare Parts  
Preparation Equipment  
Miscellaneous  
Indices

**#705 Flexible Coupling  
 with Grade “L” Silicone Gasket**

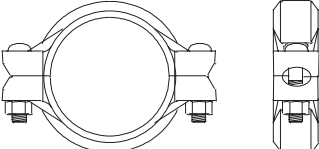
	<i>Nominal Size</i>	<i>Painted</i>	<i>List Price</i>	<i>Galvanized</i>	<i>List Price</i>
	1 1/4"	70513LS	\$182.50	70513LGS	\$197.00
	1 1/2"	70515LS	\$198.50	70515LGS	\$213.00
	2"	70520LS	\$132.50	70520LGS	\$147.00
	2 1/2"	70525LS	\$151.50	70525LGS	\$168.50
	3"	70530LS	\$167.50	70530LGS	\$189.50
	4"	70540LS	\$251.00	70540LGS	\$283.50
	5"	70550LS	\$471.00	70550LGS	\$517.00
	6"	70560LS	\$533.50	70560LGS	\$589.50
	8"	70580LS	\$658.00	70580LGS	\$756.50
	10"	70510LS	\$1,108.00	70510LGS	\$1,382.50
	12"	70512LS	\$1,283.50	70512LGS	\$1,595.00

 Orders for items in shaded areas **cannot** be cancelled or returned.

**Technical Data Sheet: G110**
**#705 Flexible Coupling  
 with Grade “O” Fluoroelastomer Gasket**

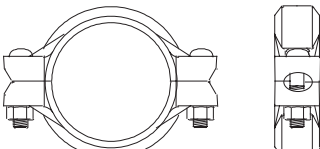
	<i>Nominal Size</i>	<i>Painted</i>	<i>List Price</i>
	1 1/4"	705130S	POA
	1 1/2"	705150S	POA
	2"	705200S	POA
	2 1/2"	705250S	POA
	3"	705300S	POA
	4"	705400S	POA
	5"	705500S	POA
	6"	705600S	POA
	8"	705800S	POA
	10"	705100S	POA
	12"	705120S	POA

 Orders for items in shaded areas **cannot** be cancelled or returned.

**Technical Data Sheet: G110**

All standard couplings can be provided with stainless steel nuts and bolts upon request.  
 See latest catalog or technical data sheets for specific approvals, listings, and design parameters.  
 POA = Price on availability. Prices subject to change without notice.

**#707 Heavy-Duty Flexible Coupling  
with Grade “E” EPDM or Grade “T” Nitrile Gasket**

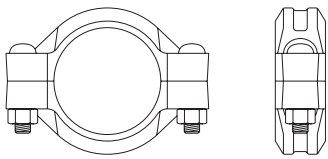

Nominal Size	Painted			Galvanized		
	Grade “E” EPDM	Grade “T” Nitrile	List Price	Grade “E” EPDM	Grade “T” Nitrile	List Price
1"	70701ES	70701TS	\$47.50	70701EGS	70701TGS	\$63.50
1½"	70715ES	70715TS	\$67.50	70715EGS	70715TGS	\$88.00
2"	70720ES	70720TS	\$72.50	70720EGS	70720TGS	\$91.00
2½"	70725ES	70725TS	\$82.50	70725EGS	70725TGS	\$117.50
3"	70730ES	70730TS	\$94.50	70730EGS	70730TGS	\$129.00
4"	70740ES	70740TS	\$132.50	70740EGS	70740TGS	\$189.50
5"	70750ES	70750TS	\$203.00	70750EGS	70750TGS	\$291.50
6"	70760ES	70760TS	\$240.50	70760EGS	70760TGS	\$344.00
8"	70780ES	70780TS	\$390.00	70780EGS	70780TGS	\$579.50
10"	70710ES	70710TS	\$635.00	70710EGS	70710TGS	\$909.50
12"	70712ES	70712TS	\$722.00	70712EGS	70712TGS	\$1,033.00
14"	70714ES	70714TS	\$1,032.00	70714EGS	70714TGS	\$1,424.00
16"	70716ES	70716TS	\$1,353.00	70716EGS	70716TGS	\$1,834.50
18"	70718ES	70718TS	\$1,583.50	70718EGS	70718TGS	\$2,193.50
20"	70721ES	70721TS	\$2,488.00	70721EGS	70721TGS	\$3,349.00
24"	70724ES	70724TS	\$2,726.50	70724EGS	70724TGS	\$3,661.50

Orders for items in shaded areas *cannot* be cancelled or returned.

**Technical Data Sheet: G130**

**#707 Heavy-Duty Flexible Coupling  
with Grade “E” EPDM or Grade “T” Nitrile Tri-Seal Gasket**

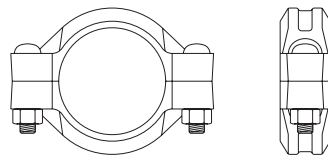

Nominal Size	Painted			Galvanized		
	Grade “E” EPDM	Grade “T” Nitrile	List Price	Grade “E” EPDM	Grade “T” Nitrile	List Price
1"	70701E3S	70701T3S	\$74.00	70701E3GS	70701T3GS	\$91.00
1½"	70715E3S	70715T3S	\$94.50	70715E3GS	70715T3GS	\$117.50
2"	70720E3S	70720T3S	\$99.50	70720E3GS	70720T3GS	\$124.50
2½"	70725E3S	70725T3S	\$120.50	70725E3GS	70725T3GS	\$153.50
3"	70730E3S	70730T3S	\$125.00	70730E3GS	70730T3GS	\$161.50
4"	70740E3S	70740T3S	\$180.00	70740E3GS	70740T3GS	\$235.50
5"	70750E3S	70750T3S	\$314.00	70750E3GS	70750T3GS	\$407.50
6"	70760E3S	70760T3S	\$348.50	70760E3GS	70760T3GS	\$456.50
8"	70780E3S	70780T3S	\$469.50	70780E3GS	70780T3GS	\$643.50
10"	70710E3S	70710T3S	\$753.50	70710E3GS	70710T3GS	\$1,012.50
12"	70712E3S	70712T3S	\$884.50	70712E3GS	70712T3GS	\$1,164.50
14"	70714E3S	70714T3S	\$1,153.00	70714E3GS	70714T3GS	\$1,527.00
16"	70716E3S	70716T3S	\$1,518.50	70716E3GS	70716T3GS	\$2,010.00
18"	70718E3S	70718T3S	\$1,783.00	70718E3GS	70718T3GS	\$2,406.50
20"	70721E3S	70721T3S	\$2,795.50	70721E3GS	70721T3GS	\$3,892.00
24"	70724E3S	70724T3S	\$3,147.00	70724E3GS	70724T3GS	\$4,104.50

Orders for items in shaded areas *cannot* be cancelled or returned.

**Technical Data Sheet: G130**

All standard couplings can be provided with stainless steel nuts and bolts upon request.  
See latest catalog or technical data sheets for specific approvals, listings, and design parameters.  
POA = Price on availability. Prices subject to change without notice.

Introduction  
Couplings & Fittings  
Mechanical Tees  
Valves  
Circuit Balancing Valves  
Accessories  
Copper Systems  
Stainless Steel Systems  
Plain End Systems  
Stainless Steel G-PRESS  
HDPE Systems  
Gaskets & Spare Parts  
Preparation Equipment  
Miscellaneous  
Indices

**#707 Heavy-Duty Flexible Coupling, Painted\*  
 with Grade “L” Silicone or Grade “O” Fluoroelastomer Gasket**

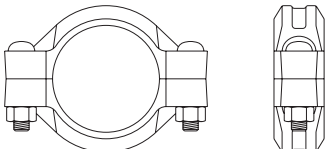
	Nominal Size	With Grade “L” Silicone Gasket		With Grade “O” Fluoroelastomer Gasket	
		Part Number	List Price	Part Number	List Price
	1½"	70715LS	\$206.00	70715OS	\$425.50
	2"	70720LS	\$143.00	70720OS	\$357.50
	2½"	70725LS	\$166.00	70725OS	\$403.00
	3"	70730LS	\$180.50	70730OS	\$448.00
	4"	70740LS	\$270.50	70740OS	\$734.00
	5"	70750LS	\$511.00	70750OS	\$832.00
	6"	70760LS	\$578.00	70760OS	\$1,020.50
	8"	70780LS	\$744.50	70780OS	\$1,261.00
	10"	70710LS	\$1,108.00	70710OS	\$1,785.00
	12"	70712LS	\$1,283.50	70712OS	\$2,471.00
	14"	70714LS	\$1,736.50	70714OS	POA
	16"	70716LS	\$1,922.00	70716OS	POA

\* Galvanized available upon request.

Orders for items in shaded areas **cannot** be cancelled or returned.

**Technical Data Sheet: G130**

**#707L Large Diameter Heavy-Duty Flexible Coupling  
 with Grade “E” EPDM or Grade “T” Nitrile Gasket**

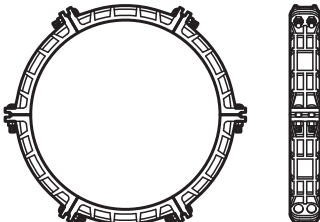
	Nominal Size	Painted			Galvanized		
		Grade “E” EPDM	Grade “T” Nitrile	List Price	Grade “E” EPDM	Grade “T” Nitrile	List Price
	26"	707L26ES	707L26TS	POA	707L26EGS	707L26TGS	POA
	28"	707L28ES	707L28TS	POA	707L28EGS	707L28TGS	POA
	30"	707L30ES	707L30TS	POA	707L30EGS	707L30TGS	POA
	32"	707L32ES	707L32TS	POA	707L32EGS	707L32TGS	POA
	36"	707L36ES	707L36TS	POA	707L36EGS	707L36TGS	POA
	40"	707L40ES	707L40TS	POA	707L40EGS	707L40TGS	POA
	42"	707L42ES	707L42TS	POA	707L42EGS	707L42TGS	POA

Orders for items in shaded areas **cannot** be cancelled or returned.

**Technical Data Sheet: G133**

All standard couplings can be provided with stainless steel nuts and bolts upon request.  
 See latest catalog or technical data sheets for specific approvals, listings, and design parameters.  
 POA = Price on availability. Prices subject to change without notice.

**#716 Reducing Coupling  
 with Grade "E" EPDM Gasket or Grade "T" Nitrile Gasket**

	Nominal Size	Painted			Galvanized		
		Grade "E" EPDM	Grade "T" Nitrile	List Price	Grade "E" EPDM	Grade "T" Nitrile	List Price
	2" x 1 1/2"	7162015ES	7162015TS	\$95.50	7162015EGS	7162015TGS	\$116.00
	2 1/2" x 2"	7162520ES	7162520TS	\$124.50	7162520EGS	7162520TGS	\$155.00
	3" x 2"	7163020ES	7163020TS	\$141.00	7163020EGS	7163020TGS	\$178.00
	3" x 2 1/2"	7163025ES	7163025TS	\$122.50	7163025EGS	7163025TGS	\$155.00
	4" x 2"	7164020ES	7164020TS	\$222.50	7164020EGS	7164020TGS	\$280.00
	4" x 2 1/2"	7164025ES	7164025TS	\$199.50	7164025EGS	7164025TGS	\$262.50
	4" x 3"	7164030ES	7164030TS	\$187.50	7164030EGS	7164030TGS	\$241.50
	5" x 4"	7165040ES	7165040TS	\$251.00	7165040EGS	7165040TGS	\$329.00
	6" x 4"	7166040ES	7166040TS	\$377.50	7166040EGS	7166040TGS	\$475.50
	6" x 5"	7166050ES	7166050TS	\$331.50	7166050EGS	7166050TGS	\$429.00
	8" x 6"	7168060ES	7168060TS	\$564.50	7168060EGS	7168060TGS	\$714.00

**Technical Data Sheet: G120**

**#702 Outlet Coupling  
 Grade "E" Gasket, Female Threaded End, Painted\***

	Nominal Size	Grade "E" EPDM	List Price
	1 1/2" x 1/2"	7021505FES	\$126.50
	1 1/2" x 3/4"	7021575FES	\$126.50
	1 1/2" x 1"	7021501FES	\$126.50
	2" x 1/2"	7022005FES	\$129.00
	2" x 3/4"	7022075FES	\$129.00
	2" x 1"	7022001FES	\$129.00
	2 1/2" x 1/2"	7022505FES	\$198.50
	2 1/2" x 3/4"	7022575FES	\$198.50
	2 1/2" x 1"	7022501FES	\$198.50
	3" x 3/4"	7023075FES	\$191.00
	3" x 1"	7023001FES	\$253.00
	4" x 3/4"	7024075FES	\$280.00
	4" x 1"	7024001FES	\$280.00
	4" x 1 1/2"	7024015FES	\$397.00
	6" x 1"	7026001FES	\$560.50
	6" x 1 1/2"	7026015FES	\$560.50

\* Galvanized available upon request.  
 Orders for items in shaded areas **cannot** be cancelled or returned.

**Technical Data Sheet: G220**

Introduction  
 Couplings & Fittings  
 Mechanical Tees  
 Valves  
 Circuit Balancing Valves  
 Accessories  
 Copper Systems  
 Stainless Steel Systems  
 Plain End Systems  
 Stainless Steel G-PRESS  
 HDPE Systems  
 Gaskets & Spare Parts  
 Preparation Equipment  
 Miscellaneous  
 Indices

**#702 Outlet Coupling**  
**Grade “E” Gasket, Male Threaded End, Painted\***

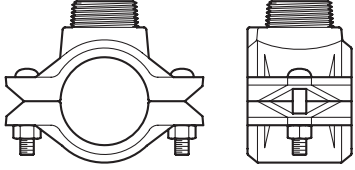
	Nominal Size	Grade “E” EPDM	List Price
	2" x 1"	7022001MES	\$129.00
	2½" x 1¼"	7022513MES	\$223.50
	2½" x 1½"	7022515MES	\$253.00
	3" x 1"	7023001MES	\$253.00
	3" x 1½"	7023015MES	\$289.50
	4" x 1"	7024001MES	\$280.00
	4" x 1½"	7024015MES	\$397.00
	4" x 2"	7024020MES	\$397.00
	6" x 1½"	7026015MES	\$560.50
6" x 2"	7026020MES	\$560.50	

\* Galvanized available upon request.

Orders for items in shaded areas **cannot** be cancelled or returned.

**Technical Data Sheet: G220**

**#702 Outlet Coupling**  
**Grade “E” Gasket, Grooved End, Painted\***

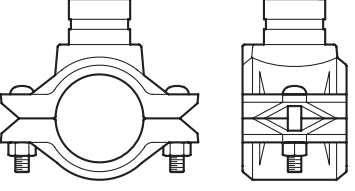
	Nominal Size	Grade “E” EPDM	List Price
	2" x 1"	7022001GRVES	\$129.00
	2½" x 1¼"	7022513GRVES	\$223.50
	2½" x 1½"	7022515GRVES	\$253.00
	3" x 1"	7023001GRVES	\$253.00
	3" x 1½"	7023015GRVES	\$289.50
	4" x 1½"	7024015GRVES	\$397.00
	4" x 2"	7024020GRVES	\$397.00
	6" x 1½"	7026015GRVES	\$560.50
	6" x 2"	7026020GRVES	\$560.50

\* Galvanized available upon request.

Orders for items in shaded areas **cannot** be cancelled or returned.

**Technical Data Sheet: G220**

**#770 High Pressure Rigid Coupling**  
**with Grade “E” EPDM or Grade “T” Nitrile Gasket**

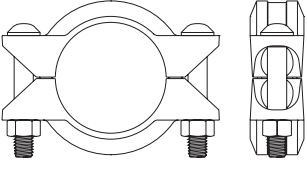
	Nominal Size	Painted			Galvanized		
		Grade “E” EPDM	Grade “T” Nitrile	List Price	Grade “E” EPDM	Grade “T” Nitrile	List Price
	2"	77020ES	77020TS	\$81.50	77020EGS	77020TGS	\$110.50
	2½"	77025ES	77025TS	\$93.50	77025EGS	77025TGS	\$125.50
	3"	77030ES	77030TS	\$104.00	77030EGS	77030TGS	\$141.00
	4"	77040ES	77040TS	\$151.00	77040EGS	77040TGS	\$215.00
	6"	77060ES	77060TS	\$271.50	77060EGS	77060TGS	\$390.50
	8"	77080ES	77080TS	\$434.00	77080EGS	77080TGS	\$623.50
	10"	77010ES	77010TS	\$801.50	77010EGS	77010TGS	\$1,096.50
	12"	77012ES	77012TS	\$1,167.00	77012EGS	77012TGS	\$1,561.50

For price and availability for the #770 High Pressure Rigid Coupling with Grade “E” EPDM Tri-Seal, Grade “T” Nitrile Tri-Seal, Grade “L” Silicone, or Grade “O” Fluoroelastomer Gasket, contact Tyco Mechanical Products.

Orders for items in shaded areas **cannot** be cancelled or returned.

**Technical Data Sheet: G138**

**#780 Snap Coupling  
with Grade “E” EPDM Gasket or Grade “T” Nitrile Gasket**

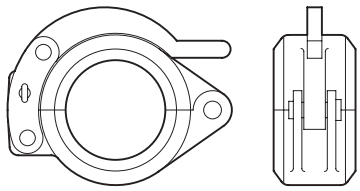
	Nominal Size	Painted			Galvanized		
		Grade “E” EPDM	Grade “T” Nitrile	List Price	Grade “E” EPDM	Grade “T” Nitrile	List Price
		1¼"	78013ES	78013TES	\$132.00	78013GES	78013GTS
1½"	78015ES	78015TES	\$126.50	78015GES	78015GTS	\$151.00	
2"	78020ES	78020TES	\$121.00	78020GES	78020GTS	\$132.50	
2½"	78025ES	78025TES	\$133.50	78025GES	78025GTS	\$159.00	
3"	78030ES	78030TES	\$155.00	78030GES	78030GTS	\$190.50	
4"	78040ES	78040TES	\$198.50	78040GES	78040GTS	\$255.00	
5"	78050ES	78050TES	\$403.00	78050GES	78050GTS	\$493.50	
6"	78060ES	78060TES	\$422.50	78060GES	78060GTS	\$534.00	
8"	78080ES	78080TES	\$647.50	78080GES	78080GTS	\$810.50	

Orders for items in shaded areas *cannot* be cancelled or returned.

**Technical Data Sheet: G145**

**#71H Grooved Flange Adapter - Hinged  
with Grade “E” EPDM Gasket or Grade “T” Nitrile Gasket**

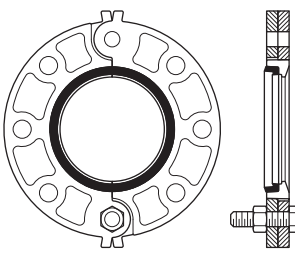
	Nominal Size	Painted			Galvanized		
		Grade “E” EPDM	Grade “T” Nitrile	List Price	Grade “E” EPDM	Grade “T” Nitrile	List Price
		2"	71H20S	71H20TS	\$281.00	71H20GS	71H20TGS
2½"	71H25S	71H25TS	\$349.00	71H25GS	71H25TGS	\$429.00	
3"	71H30S	71H30TS	\$376.50	71H30GS	71H30TGS	\$465.50	
4"	71H40S	71H40TS	\$502.00	71H40GS	71H40TGS	\$622.00	
5"	71H50S	71H50TS	\$583.00	71H50GS	71H50TGS	\$721.00	
6"	71H60S	71H60TS	\$635.50	71H60GS	71H60TGS	\$790.50	
8"	71H80S	71H80TS	\$718.00	71H80GS	71H80TGS	\$920.00	
10"	71H10S	71H10TS	\$1,134.00	71H10GS	71H10TGS	\$1,441.50	
12"	71H12S	71H12TS	\$1,483.00	71H12GS	71H12TGS	\$1,905.50	

**Technical Data Sheet: G155**

**#71H Grooved Flange Adapter - Hinged  
with Grade “O” Fluoroelastomer Gasket**

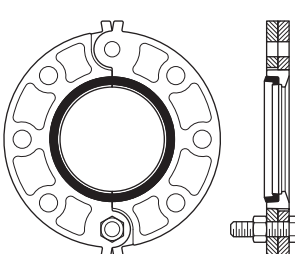
	Nominal Size	Painted		Galvanized	
		Grade “O” Fluoroelastomer	List Price	Grade “O” Fluoroelastomer	List Price
		2"	71H200S	POA	71H200GS
2½"	71H250S	POA	71H250GS	POA	
3"	71H300S	POA	71H300GS	POA	
4"	71H400S	POA	71H400GS	POA	
5"	71H500S	POA	71H500GS	POA	
6"	71H600S	POA	71H600GS	POA	
8"	71H800S	POA	71H800GS	POA	
10"	71H100S	POA	71H100GS	POA	
12"	71H120S	POA	71H120GS	POA	

Orders for items in shaded areas *cannot* be cancelled or returned.

**Technical Data Sheet: G155**

All standard couplings can be provided with stainless steel nuts and bolts upon request.  
See latest catalog or technical data sheets for specific approvals, listings, and design parameters.  
POA = Price on availability. Prices subject to change without notice.

Introduction  
Couplings & Fittings  
Mechanical Tees  
Valves  
Circuit Balancing Valves  
Accessories  
Copper Systems  
Stainless Steel Systems  
Plain End Systems  
Stainless Steel G-PRESS  
HDPE Systems  
Gaskets & Spare Parts  
Preparation Equipment  
Miscellaneous  
Indices

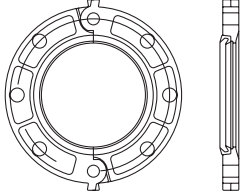
**#71 Grooved Flange Adapter  
 with Grade "E" EPDM Gasket or Grade "T" Nitrile Gasket**

Nominal Size	Painted			Galvanized		
	Grade "E" EPDM	Grade "T" Nitrile	List Price	Grade "E" EPDM	Grade "T" Nitrile	List Price
2"	7120S	7120TS	\$281.00	7120GS	7120TGS	\$340.00
2½"	7125S	7125TS	\$349.00	7125GS	7125TGS	\$429.00
3"	7130S	7130TS	\$376.50	7130GS	7130TGS	\$465.50
4"	7140S	7140TS	\$502.00	7140GS	7140TGS	\$622.00
5"	7150S	7150TS	\$583.00	7150GS	7150TGS	\$721.00
6"	7160S	7160TS	\$635.50	7160GS	7160TGS	\$790.50
8"	7180S	7180TS	\$718.00	7180GS	7180TGS	\$920.00
10"	7110S	7110TS	\$1,134.00	7110GS	7110TGS	\$1,441.50
12"	7112S	7112TS	\$1,483.00	7112GS	7112TGS	\$1,905.50
14"	7114S	7114TS	\$2,735.50	7114GS	7114TGS	\$3,365.50
16"	7116S	7116TS	\$3,175.00	7116GS	7116TGS	\$3,935.00
18"	7118S	7118TS	\$3,907.50	7118GS	7118TGS	\$4,979.50
20"	7121S	7121TS	\$4,701.00	7121GS	7121TGS	\$6,015.50
24"	7124S	7124TS	\$6,015.50	7124GS	7124TGS	\$7,760.50

 Orders for items in shaded areas *cannot* be cancelled or returned.

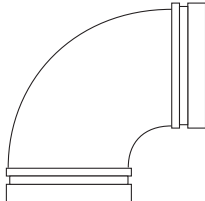
**Technical Data Sheet: G150**
**#210 Grooved 90° Elbow**

Nominal Size	Painted	List Price	Galvanized	List Price
1¼"	21013S	\$85.00	21013GS	\$112.50
1½"	21015S	\$85.00	21015GS	\$112.50
2"	21020S	\$85.00	21020GS	\$112.50
2½"	21025S	\$85.00	21025GS	\$112.50
3"	21030S	\$150.00	21030GS	\$187.50
4"	21040S	\$163.00	21040GS	\$228.00
5"	21050S	\$388.00	21050GS	\$501.50
6"	21060S	\$456.00	21060GS	\$603.50
8"	21080S	\$948.50	21080GS	\$1,249.50
10"	21010S	\$1,755.00	21010GS	\$2,194.00
12"	21012S	\$2,663.00	21012GS	\$3,436.00

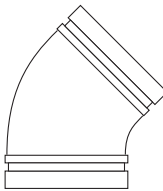
**Technical Data Sheet: G180**
**#201 Grooved 45° Elbow**

Nominal Size	Painted	List Price	Galvanized	List Price
1¼"	20113S	\$85.00	20113GS	\$107.50
1½"	20115S	\$85.00	20115GS	\$107.50
2"	20120S	\$85.00	20120GS	\$107.50
2½"	20125S	\$85.00	20125GS	\$107.50
3"	20130S	\$150.00	20130GS	\$176.50
4"	20140S	\$163.00	20140GS	\$211.50
5"	20150S	\$388.00	20150GS	\$481.00
6"	20160S	\$456.00	20160GS	\$575.50
8"	20180S	\$948.50	20180GS	\$1,189.50
10"	20110S	\$1,664.00	20110GS	\$1,815.00
12"	20112S	\$2,663.00	20112GS	\$3,103.00

 Orders for items in shaded areas *cannot* be cancelled or returned.

**Technical Data Sheet: G180**



## Tyco Mechanical Products Section 2 – Couplings & Fittings



### #212 and #312 – Grooved 22<sup>1</sup>/<sub>2</sub>° Elbow

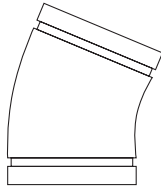

<i>Nominal Size</i>	<i>Painted</i>	<i>List Price</i>	<i>Galvanized</i>	<i>List Price</i>
1 <sup>1</sup> / <sub>4</sub> " *	21213S	\$93.00	21213GS	\$117.50
1 <sup>1</sup> / <sub>2</sub> " *	21215S	\$93.00	21215GS	\$117.50
2" *	21220S	\$93.00	21220GS	\$117.50
2 <sup>1</sup> / <sub>2</sub> " *	21225S	\$93.00	21225GS	\$117.50
3" *	21230S	\$133.50	21230GS	\$167.00
4" *	21240S	\$176.00	21240GS	\$228.00
5" *	21250S	\$537.50	21250GS	\$648.50
6" *	21260S	\$492.00	21260GS	\$626.50
8" *	21280S	\$1,024.50	21280GS	\$1,273.00
10"	31210S	\$1,351.50	31210GS	\$1,755.50
12"	31212S	\$1,826.50	31212GS	\$2,265.00
14"	31214S	\$1,273.50	31214GS	\$1,686.00
16"	31216S	\$1,527.00	31216GS	\$2,138.50
18"	31218S	\$1,849.00	31218GS	\$2,624.00
20"	31221S	\$2,321.50	31221GS	\$3,648.00
24"	31224S	\$3,961.00	31224GS	\$4,581.00

Elbow is segmentally welded except where a \* indicates it is available as a cast fitting.

Orders for items in shaded areas **cannot** be cancelled or returned.

**Technical Data Sheet: G180**

### #211 and #311 – Grooved 11<sup>1</sup>/<sub>4</sub>° Elbow

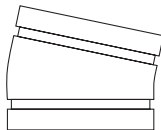

<i>Nominal Size</i>	<i>Painted</i>	<i>List Price</i>	<i>Galvanized</i>	<i>List Price</i>
1 <sup>1</sup> / <sub>4</sub> " *	21113S	\$93.00	21113GS	\$117.50
1 <sup>1</sup> / <sub>2</sub> " *	21115S	\$93.00	21115GS	\$117.50
2" *	21120S	\$213.50	21120GS	\$249.00
2 <sup>1</sup> / <sub>2</sub> " *	21125S	\$213.50	21125GS	\$249.00
3" *	21130S	\$133.50	21130GS	\$166.00
4" *	21140S	\$163.00	21140GS	\$216.00
5" *	21150S	\$537.50	21150GS	\$632.50
6" *	21160S	\$492.00	21160GS	\$594.50
8" *	21180S	\$875.50	21180GS	\$1,040.50
10"	75309	\$1,262.00	75315	\$1,506.50
12"	75310	\$1,826.50	75323	\$2,212.00
14"	75311	\$1,152.00	75324	\$1,445.50
16"	75312	\$1,418.50	75325	\$1,891.00
18"	31118S	\$1,717.50	75326	\$2,328.00
20"	31121S	\$2,102.00	75327	\$2,912.50
24"	31124S	\$3,668.00	75328	\$3,700.50

Elbow is segmentally welded except where a \* indicates it is available as a cast fitting.

Orders for items in shaded areas **cannot** be cancelled or returned.

**Technical Data Sheet: G180**

Introduction  
Couplings & Fittings  
Mechanical Tees  
Valves  
Circuit Balancing Valves  
Accessories  
Copper Systems  
Stainless Steel Systems  
Plain End Systems  
Stainless Steel G-PRESS  
HDPE Systems  
Gaskets & Spare Parts  
Preparation Equipment  
Miscellaneous  
Indices

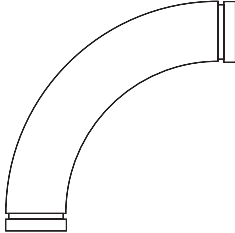
**#210LR and #310LR – Grooved 90° Long Radius Elbow**

<i>Nominal Size</i>	<i>Painted</i>	<i>List Price</i>	<i>Galvanized</i>	<i>List Price</i>
1 1/4"	<b>73500</b>	POA	<b>310LR13GS</b>	POA
1 1/2"	<b>73501</b>	POA	<b>310LR15GS</b>	POA
2"	<b>75780</b>	\$192.50	<b>310L20GS</b>	\$252.00
2 1/2"	<b>75781</b>	\$241.00	<b>310L25GS</b>	\$276.50
3"	<b>75782</b>	\$192.50	<b>73506</b>	\$252.00
4"	<b>75783</b>	\$286.00	<b>73507</b>	\$382.50
5"	<b>75825</b>	\$1,450.00	<b>73508</b>	\$1,661.50
6"	<b>75784</b>	\$830.00	<b>73509</b>	\$1,090.00
8"	<b>75785</b>	\$1,983.00	<b>73510</b>	\$2,534.50
10"	<b>75786</b>	\$3,965.00	<b>310L10GS</b>	\$4,779.00
12"	<b>75787</b>	\$4,005.00	<b>73512</b>	\$5,316.00
14" *	<b>210L14S</b>	\$2,869.00	<b>210L14GS</b>	\$3,722.50
16" *	<b>210L16S</b>	\$3,725.00	<b>210L16GS</b>	\$4,817.50
18"	<b>75790</b>	\$4,728.00	<b>310LR18GS</b>	\$5,892.50
20"	<b>75826</b>	\$6,231.50	<b>310LR21GS</b>	\$7,732.50
24"	<b>75827</b>	\$9,024.00	<b>73517</b>	\$11,233.50

Elbow is segmentally welded except where a \* indicates it is available as a cast fitting.

 Orders for items in shaded areas **cannot** be cancelled or returned.

**Technical Data Sheet: G180**
**#201LR and #301LR – Grooved 45° Long Radius Elbow**

<i>Nominal Size</i>	<i>Painted</i>	<i>List Price</i>	<i>Galvanized</i>	<i>List Price</i>
1 1/4"	<b>301L13S</b>	POA	<b>301L13GS</b>	POA
1 1/2"	<b>301L15S</b>	POA	<b>301L15GS</b>	POA
2"	<b>75791</b>	\$167.00	<b>301L20GS</b>	\$211.50
2 1/2"	<b>75792</b>	\$533.50	<b>301L25GS</b>	\$600.00
3"	<b>75793</b>	\$167.00	<b>73525</b>	\$211.50
4"	<b>75794</b>	\$203.00	<b>73526</b>	\$269.50
5"	<b>75795</b>	\$1,347.00	<b>301L50GS</b>	\$1,478.00
6"	<b>75796</b>	\$595.50	<b>73528</b>	\$763.00
8"	<b>75797</b>	\$1,035.00	<b>301L80GS</b>	\$1,345.00
10"	<b>75798</b>	\$2,974.00	<b>301L10GS</b>	\$3,184.00
12"	<b>75799</b>	\$3,444.00	<b>301L12GS</b>	\$4,228.00
14" *	<b>201L14S</b>	\$2,148.50	<b>201L14GS</b>	\$2,750.00
16" *	<b>201L16S</b>	\$2,417.50	<b>201L16GS</b>	\$3,001.00
18"	<b>75829</b>	\$2,834.00	<b>301L18GS</b>	\$3,474.00
20"	<b>75830</b>	\$3,722.50	<b>301L21GS</b>	\$4,864.00
24"	<b>75832</b>	\$5,654.00	<b>301L24GS</b>	\$6,966.00

Elbow is segmentally welded except where a \* indicates it is available as a cast fitting.

 Orders for items in shaded areas **cannot** be cancelled or returned.

**Technical Data Sheet: G180**

## Tyco Mechanical Products Section 2 – Couplings & Fittings



### #310 - 3D, #310 - 5D, #310 - 6D Long Radius 90° Elbow, Painted

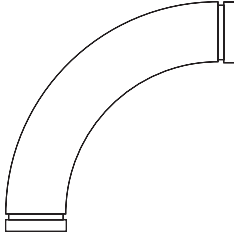

Nominal Size	3D	List Price	5D	List Price	6D	List Price
2"	310203D	\$1,388.00	310205D	\$1,489.50	310206D	\$1,527.50
2½"	310253D	\$1,482.50	310255D	\$1,533.50	310256D	\$1,597.00
3"	310303D	\$1,691.50	310305D	\$1,805.50	310306D	\$1,837.00
4"	310403D	\$1,888.00	310405D	\$2,034.00	310406D	\$2,135.50
5"	310503D	\$2,122.00	310505D	\$2,395.00	310506D	\$2,445.50
6"	310603D	\$2,489.50	310605D	\$2,755.50	310606D	\$2,971.50
8"	310803D	\$3,269.00	310805D	\$3,813.50	310806D	\$4,142.00
10"	310103D	\$4,148.00	310105D	\$5,263.50	310106D	\$5,719.00
12"	310123D	\$5,269.00	310125D	\$6,674.50	310126D	\$7,523.00
14"	310143D	\$6,405.50	310145D	\$8,369.00	310146D	\$9,366.50
16"	310163D	\$7,766.50	310165D	\$10,067.50	310166D	\$11,596.00
18"	310183D	\$10,735.00	310185D	\$13,923.50	310186D	\$15,355.00
20"	310213D	\$12,944.50	310215D	\$16,522.00	310216D	\$18,148.50
24"	310243D	\$18,103.00	310245D	\$23,346.00	310246D	\$26,113.50

Elbow is segmentally welded.

Orders for items in shaded areas **cannot** be cancelled or returned.

**Technical Data Sheet: G180**

### #306 - 3D, #306 - 5D, #306 - 6D, Long Radius 60° Elbow, Painted

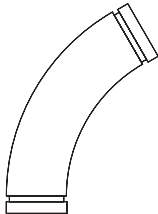

Nominal Size	3D	List Price	5D	List Price	6D	List Price
2"	306203D	\$1,342.50	306205D	\$1,413.00	306206D	\$1,438.50
2½"	306253D	\$1,406.00	306255D	\$1,482.50	306256D	\$1,501.50
3"	306303D	\$1,610.00	306305D	\$1,698.50	306306D	\$1,717.50
4"	306403D	\$1,837.00	306405D	\$1,888.00	306406D	\$1,983.50
5"	306503D	\$2,059.50	306505D	\$2,211.00	306506D	\$2,242.50
6"	306603D	\$2,294.00	306605D	\$2,489.50	306606D	\$2,527.50
8"	306803D	\$2,882.50	306805D	\$3,180.00	306806D	\$3,459.00
10"	306103D	\$3,654.50	306105D	\$4,174.00	306106D	\$4,547.00
12"	306123D	\$4,357.50	306125D	\$5,567.50	306126D	\$6,041.00
14"	306143D	\$5,322.50	306145D	\$6,735.50	306146D	\$7,299.50
16"	306163D	\$6,476.00	306165D	\$8,128.50	306166D	\$8,790.50
18"	306183D	\$9,074.50	306185D	\$11,065.00	306186D	\$12,295.50
20"	306213D	\$10,565.50	306215D	\$12,795.50	306216D	\$14,183.00
24"	306243D	\$14,797.50	306245D	\$18,298.50	306246D	\$20,144.50

Elbow is segmentally welded.

Orders for items in shaded areas **cannot** be cancelled or returned.

**Technical Data Sheet: G180**

Introduction  
Couplings & Fittings  
Mechanical Tees  
Valves  
Circuit Balancing Valves  
Accessories  
Copper Systems  
Stainless Steel Systems  
Plain End Systems  
Stainless Steel G-PRESS  
HDPE Systems  
Gaskets & Spare Parts  
Preparation Equipment  
Miscellaneous  
Indices

**#301 -3D, #301 - 5D, #301 -6D, Long Radius 45° Elbow, Painted**

	Nominal Size	3D	List Price	5D	List Price	6D	List Price
	2"	301203D	\$1,318.00	301205D	\$1,356.50	301206D	\$1,375.00
	2½"	301253D	\$1,394.00	301255D	\$1,420.00	301256D	\$1,470.50
	3"	301303D	\$1,591.00	301305D	\$1,666.50	301306D	\$1,686.00
	4"	301403D	\$1,749.00	301405D	\$1,851.00	301406D	\$1,869.00
	5"	301503D	\$1,940.00	301505D	\$2,072.00	301506D	\$2,097.50
	6"	301603D	\$2,256.00	301605D	\$2,312.50	301606D	\$2,457.50
	8"	301803D	\$2,806.50	301805D	\$3,041.00	301806D	\$3,111.00
	10"	301103D	\$3,293.50	301105D	\$3,743.00	301106D	\$4,078.50
	12"	301123D	\$4,180.00	301125D	\$4,737.50	301126D	\$5,161.00
	14"	301143D	\$4,784.50	301145D	\$5,770.00	301146D	\$6,268.50
	16"	301163D	\$5,834.00	301165D	\$6,989.00	301166D	\$7,571.50
	18"	301183D	\$8,252.00	301185D	\$9,639.00	301186D	\$10,358.50
	20"	301213D	\$9,600.00	301215D	\$11,162.00	301216D	\$12,425.50
	24"	301243D	\$12,841.00	301245D	\$15,465.50	301246D	\$17,157.00

Elbow is segmentally welded.

 Orders for items in shaded areas **cannot** be cancelled or returned.

**Technical Data Sheet: G180**
**#303 - 3D, #303 - 5D, #303 - 6D, Long Radius 30° Elbow, Painted**

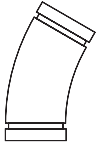
	Nominal Size	3D	List Price	5D	List Price	6D	List Price
	2"	303203D	\$1,293.00	303205D	\$1,318.00	303206D	\$1,331.00
	2½"	303253D	\$1,375.00	303255D	\$1,394.00	303256D	\$1,401.50
	3"	303303D	\$1,571.50	303305D	\$1,591.00	303306D	\$1,603.00
	4"	303403D	\$1,724.50	303405D	\$1,813.00	303406D	\$1,825.00
	5"	303503D	\$1,907.50	303505D	\$2,028.00	303506D	\$2,040.00
	6"	303603D	\$2,104.00	303605D	\$2,256.00	303606D	\$2,274.00
	8"	303803D	\$2,559.50	303805D	\$2,749.00	303806D	\$2,775.50
	10"	303103D	\$2,932.50	303105D	\$3,307.00	303106D	\$3,610.00
	12"	303123D	\$3,718.50	303125D	\$4,186.50	303126D	\$4,282.00
	14"	303143D	\$4,246.00	303145D	\$5,109.00	303146D	\$5,232.00
	16"	303163D	\$5,187.00	303165D	\$5,834.00	303166D	\$6,346.50
	18"	303183D	\$7,415.50	303185D	\$8,219.50	303186D	\$8,822.00
	20"	303213D	\$8,187.00	303215D	\$9,522.00	303216D	\$10,222.50
	24"	303243D	\$10,896.00	303245D	\$13,248.50	303246D	\$14,169.50

Elbow is segmentally welded.

 Orders for items in shaded areas **cannot** be cancelled or returned.

**Technical Data Sheet: G180**

## Tyco Mechanical Products Section 2 – Couplings & Fittings

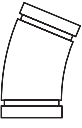

### #312 3D, #312 - 5D, #312 - 6D, Long Radius 22<sup>1</sup>/<sub>2</sub>° Elbow, Painted

	Nominal Size	3D	List Price	5D	List Price	6D	List Price
	2"	312203D	\$1,281.50	312205D	\$1,306.00	312206D	\$1,313.00
	2 <sup>1</sup> / <sub>2</sub> "	312253D	\$1,370.00	312255D	\$1,382.00	312256D	\$1,388.50
	3"	312303D	\$1,559.00	312305D	\$1,578.00	312306D	\$1,584.00
	4"	312403D	\$1,710.00	312405D	\$1,730.00	312406D	\$1,742.50
	5"	312503D	\$1,888.00	312505D	\$1,913.50	312506D	\$1,925.50
	6"	312603D	\$2,084.00	312605D	\$2,109.50	312606D	\$2,242.50
	8"	312803D	\$2,521.50	312805D	\$2,533.50	312806D	\$2,731.00
	10"	312103D	\$2,895.00	312105D	\$3,204.50	312106D	\$3,255.50
	12"	312123D	\$3,629.50	312125D	\$3,768.00	312126D	\$4,123.00
	14"	312143D	POA	312145D	\$4,628.50	312146D	POA
	16"	312163D	\$5,050.00	312165D	\$5,627.50	312166D	\$5,736.50
	18"	312183D	\$6,800.50	312185D	\$7,501.00	312186D	\$8,064.00
	20"	312213D	\$7,921.50	312215D	\$8,705.50	312216D	\$9,341.00
24"	312243D	\$10,520.50	312245D	\$11,531.50	312246D	\$12,373.50	

Elbow is segmentally welded.

Orders for items in shaded areas **cannot** be cancelled or returned.

**Technical Data Sheet: G180**

### #311 - 3D, #311 - 5D, #311 - 6D, Long Radius 11<sup>1</sup>/<sub>4</sub>° Elbow, Painted

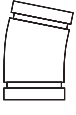
	Nominal Size	3D	List Price	5D	List Price	6D	List Price
	2"	311203D	\$1,267.00	311205D	\$1,274.50	311206D	\$1,281.50
	2 <sup>1</sup> / <sub>2</sub> "	311253D	\$1,356.50	311255D	\$1,362.50	311256D	\$1,362.50
	3"	311303D	\$1,547.00	311305D	\$1,552.00	311306D	\$1,559.00
	4"	311403D	\$1,692.00	311405D	\$1,698.50	311406D	\$1,704.50
	5"	311503D	\$1,862.50	311505D	\$1,876.00	311506D	\$1,881.50
	6"	311603D	\$2,053.00	311605D	\$2,065.00	311606D	\$2,078.50
	8"	311803D	\$2,294.00	311805D	\$2,471.00	311806D	\$2,483.50
	10"	311103D	\$2,610.00	311105D	\$2,864.00	311106D	\$2,876.00
	12"	311123D	\$3,218.50	311125D	\$3,287.50	311126D	\$3,603.50
	14"	311143D	\$3,650.50	311145D	\$4,052.00	311146D	\$4,097.50
	16"	311163D	\$4,473.50	311165D	\$4,583.50	311166D	\$4,998.50
	18"	311183D	\$6,081.00	311185D	\$6,631.50	311186D	\$6,709.50
	20"	311213D	\$7,091.50	311215D	\$7,254.00	311216D	\$7,792.50
24"	311243D	\$9,360.00	311245D	\$9,554.50	311246D	\$10,287.00	

Elbow is segmentally welded.

Orders for items in shaded areas **cannot** be cancelled or returned.

**Technical Data Sheet: G180**

Introduction
Couplings & Fittings
Mechanical Tees
Valves
Circuit Balancing Valves
Accessories
Copper Systems
Stainless Steel Systems
Plain End Systems
Stainless Steel G-PRESS
HDPE Systems
Gaskets & Spare Parts
Preparation Equipment
Miscellaneous
Indices

**#316 Reducing Base Support Elbow, Groove x Flange**

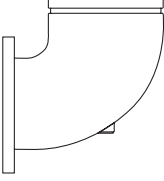
	<i>Nominal Size</i>	<i>Painted</i>	<i>List Price</i>	<i>Galvanized</i>	<i>List Price</i>
	6" x 4"	72646	\$1,533.00	72670	POA
	6" x 5"	72647	\$1,735.50	72671	POA
	8" x 5"	72645	POA	72672	POA
	8" x 6"	72649	\$2,330.00	72673	POA
	10" x 6"	72650	POA	72674	POA
	10" x 8"	72651	\$3,359.50	72675	POA
	12" x 8"	72652	POA	3161208GS	POA
	12" x 10"	72653	POA	3161210GS	POA

Elbow is segmentally welded.

 Orders for items in shaded areas **cannot** be cancelled or returned.

**#315 Groove x Male Thread – Adapter 90° Elbow**

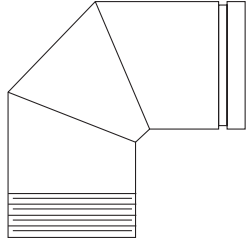
	<i>Nominal Size</i>	<i>Painted</i>	<i>List Price</i>	<i>Galvanized</i>	<i>List Price</i>
	1 1/4"	75761	\$164.00	31513GS	\$181.50
	1 1/2"	75762	\$208.50	31515GS	\$242.00
	2"	75763	\$146.50	73542	\$181.50
	2 1/2"	75764	\$254.00	73543	\$277.50
	3"	75765	\$235.50	73544	\$288.50
	4"	75766	POA	31540GS	POA
	6"	75767	\$727.50	31560GS	\$920.00

Elbow is segmentally welded.

 Orders for items in shaded areas **cannot** be cancelled or returned.

**Technical Data Sheet: G180**

# Tyco Mechanical Products

## Section 2 – Couplings & Fittings



### #219 and #319 – Grooved Tee

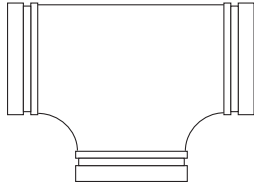

Nominal Size	Painted	List Price	Galvanized	List Price
1 1/4" *	21913S	\$132.00	21913GS	\$172.00
1 1/2" *	21915S	\$132.00	21915GS	\$172.00
2" *	21920S	\$132.00	21920GS	\$172.00
2 1/2" *	21925S	\$132.00	21925GS	\$172.00
3" *	21930S	\$180.50	21930GS	\$246.50
4" *	21940S	\$274.50	21940GS	\$372.50
5" *	21950S	\$639.00	21950GS	\$810.50
6" *	21960S	\$737.50	21960GS	\$1,006.00
8" *	21980S	\$1,615.00	21980GS	\$2,119.00
10" *	21910S	\$3,237.00	21910GS	\$4,191.00
12" *	21912S	\$4,512.00	21912GS	\$5,763.00
14" *	21914S	\$2,880.50	21914GS	\$3,587.00
16" *	21916S	\$3,253.00	21916GS	\$4,131.50
18"	73565	\$4,066.00	31918GS	\$5,242.50
20"	73566	\$5,826.00	31921GS	\$7,386.00
24"	73567	\$8,882.00	73572	\$11,520.00

Tee is segmentally welded except where a \* indicates it is available as a cast fitting.

Orders for items in shaded areas **cannot** be cancelled or returned.

**Technical Data Sheet: G180**

### #320 Groove x Male Thread – Tee

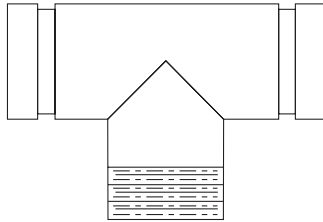

Nominal Size	Painted	List Price	Galvanized	List Price
1 1/4"	32013S	\$275.50	32013GS	\$323.50
1 1/2"	75490	\$429.00	32015GS	\$505.50
2"	75491	\$275.50	32020GS	\$323.50
2 1/2"	75492	POA	32025GS	POA
3"	75493	POA	32030GS	POA
4"	75465	\$569.00	32040GS	\$782.50
5"	32050S	\$1,634.00	32050GS	POA
6"	75466	\$1,459.00	32060GS	\$1,717.00
8"	32080S	POA	32080GS	POA
10"	32010S	POA	32010GS	POA
12"	32012S	POA	32012GS	POA

Tee is segmentally welded.

Orders for items in shaded areas **cannot** be cancelled or returned.

**Technical Data Sheet: G180**

Introduction  
 Couplings & Fittings  
 Mechanical Tees  
 Valves  
 Circuit Balancing Valves  
 Accessories  
 Copper Systems  
 Stainless Steel Systems  
 Plain End Systems  
 Stainless Steel G-PRESS  
 HDPE Systems  
 Gaskets & Spare Parts  
 Preparation Equipment  
 Miscellaneous  
 Indices

**#221 and #321 – Grooved Reducing Tee**

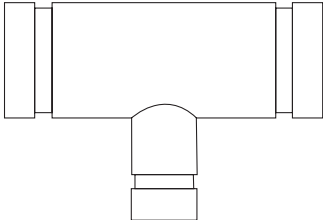
	<i>Nominal Size</i>	<i>Painted</i>	<i>List Price</i>	<i>Galvanized</i>	<i>List Price</i>
	1½" x 1½" x 1¼"	<b>73580</b>	\$244.50	<b>73589</b>	\$270.50
	2" x 2" x 1"	<b>75410</b>	\$277.50	<b>75470</b>	\$325.00
	* 2" x 2" x 1½"	<b>2212015S</b>	\$277.50	<b>2212015GS</b>	\$330.00
	2½" x 2½" x 1"	<b>75412</b>	\$277.50	<b>3212510GS</b>	\$325.00
	2½" x 2½" x 1¼"	<b>75413</b>	\$418.00	<b>73590</b>	\$492.00
	2½" x 2½" x 1½"	<b>75414</b>	\$277.50	<b>73591</b>	\$330.00
	* 2½" x 2½" x 2"	<b>2212520S</b>	\$277.50	<b>2212520GS</b>	\$330.00
	* 3" x 3" x 1"	<b>2213010S</b>	\$245.00	<b>2213010GS</b>	\$312.50
	* 3" x 3" x 1½"	<b>2213015S</b>	\$245.00	<b>2213015GS</b>	\$316.00
	* 3" x 3" x 2"	<b>2213020S</b>	\$245.00	<b>2213020GS</b>	\$316.00
	* 3" x 3" x 2½"	<b>2213025S</b>	\$245.00	<b>2213025GS</b>	\$316.00
	4" x 4" x 1"	<b>75420</b>	\$330.00	<b>3214010GS</b>	\$412.00
	4" x 4" x 1¼"	<b>73575</b>	\$648.50	<b>73593</b>	\$755.00
	4" x 4" x 1½"	<b>75421</b>	\$330.00	<b>73594</b>	\$412.00
	* 4" x 4" x 2"	<b>2214020S</b>	\$330.00	<b>2214020GS</b>	\$432.50
	* 4" x 4" x 2½"	<b>2214025S</b>	\$330.00	<b>2214025GS</b>	\$432.50
	* 4" x 4" x 3"	<b>2214030S</b>	\$330.00	<b>2214030GS</b>	\$432.50
	5" x 5" x 2"	<b>75425</b>	\$799.00	<b>73595</b>	\$987.00
	* 5" x 5" x 2½"	<b>2215025S</b>	\$651.00	<b>2215025GS</b>	\$819.50
	* 5" x 5" x 3"	<b>2215030S</b>	\$651.00	<b>2215030GS</b>	\$819.50
	* 5" x 5" x 4"	<b>2215040S</b>	\$704.50	<b>2215040GS</b>	\$890.00
	* 6" x 6" x 2"	<b>2216020S</b>	\$775.50	<b>2216020GS</b>	\$1,018.50
	* 6" x 6" x 2½"	<b>2216025S</b>	\$775.50	<b>2216025GS</b>	\$1,018.50
	* 6" x 6" x 3"	<b>2216030S</b>	\$775.50	<b>2216030GS</b>	\$1,018.50
	* 6" x 6" x 4"	<b>2216040S</b>	\$775.50	<b>2216040GS</b>	\$1,018.50
	6" x 6" x 5"	<b>75433</b>	\$775.50	<b>3216050GS</b>	\$1,024.50
	8" x 8" x 2"	<b>73576</b>	\$1,117.50	<b>73599</b>	\$1,411.00
	8" x 8" x 2½"	<b>73574</b>	\$1,117.50	<b>3218025GS</b>	\$1,411.00
	8" x 8" x 3"	<b>75435</b>	\$1,204.00	<b>75482</b>	\$1,438.50
	* 8" x 8" x 4"	<b>2218040S</b>	\$1,615.00	<b>2218040GS</b>	\$2,087.00
8" x 8" x 5"	<b>75437</b>	\$1,615.00	<b>75484</b>	\$2,100.50	
* 8" x 8" x 6"	<b>2218060S</b>	\$1,615.00	<b>2218060GS</b>	\$2,109.50	
10" x 10" x 2"	<b>75461</b>	\$1,878.00	<b>73620</b>	\$2,851.00	
10" x 10" x 3"	<b>75439</b>	\$1,878.00	<b>73621</b>	\$2,989.00	
10" x 10" x 4"	<b>75440</b>	\$1,964.00	<b>73622</b>	\$2,510.00	
10" x 10" x 5"	<b>75441</b>	\$2,007.00	<b>3211005GS</b>	\$2,562.00	
10" x 10" x 6"	<b>75442</b>	\$2,007.00	<b>73624</b>	\$3,259.00	
10" x 10" x 8"	<b>75443</b>	\$2,044.00	<b>73625</b>	\$3,275.00	
12" x 12" x 3"	<b>73600</b>	\$2,529.00	<b>3211230GS</b>	\$3,264.00	
12" x 12" x 4"	<b>73577</b>	\$2,710.00	<b>73627</b>	\$3,811.00	
12" x 12" x 5"	<b>73578</b>	\$2,864.00	<b>3211205GS</b>	\$3,721.00	
12" x 12" x 6"	<b>75444</b>	\$2,899.00	<b>73629</b>	\$4,253.00	
12" x 12" x 8"	<b>75445</b>	\$2,980.00	<b>73630</b>	\$4,506.00	
12" x 12" x 10"	<b>75446</b>	\$3,119.00	<b>73631</b>	\$4,849.00	
14" x 14" x 6"	<b>75447</b>	\$1,923.00	<b>3211460GS</b>	\$2,466.00	
14" x 14" x 8"	<b>73579</b>	\$1,970.00	<b>73633</b>	\$2,507.00	
14" x 14" x 10"	<b>75448</b>	\$2,083.00	<b>3211410GS</b>	\$2,656.00	
14" x 14" x 12"	<b>75449</b>	\$2,230.00	<b>75486</b>	\$2,856.00	

See latest catalog or technical data sheets for specific approvals, listings, and design parameters.  
 POA = Price on availability. Prices subject to change without notice.

Customer Service: (800) 558-5236



## Tyco Mechanical Products Section 2 – Couplings & Fittings



### #221 and #321 – Grooved Reducing Tee

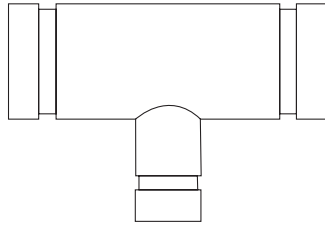

(Continued from Previous page)

<i>Nominal Size</i>	<i>Painted</i>	<i>List Price</i>	<i>Galvanized</i>	<i>List Price</i>
16" x 16" x 4"	<b>75454</b>	POA	<b>73635</b>	POA
16" x 16" x 8"	<b>75450</b>	\$2,356.00	<b>73636</b>	\$2,986.00
16" x 16" x 10"	<b>75451</b>	\$2,545.50	<b>3211610GS</b>	\$3,225.00
16" x 16" x 12"	<b>75452</b>	\$2,596.50	<b>75469</b>	\$3,298.50
16" x 16" x 14"	<b>75453</b>	\$3,040.50	<b>3211614GS</b>	\$3,781.00
18" x 18" x 8"	<b>75455</b>	\$3,002.00	<b>3211880GS</b>	\$3,971.00
18" x 18" x 10"	<b>75456</b>	\$3,115.50	<b>3211810GS</b>	\$4,012.50
18" x 18" x 12"	<b>75457</b>	\$3,115.50	<b>3211812GS</b>	\$4,051.50
18" x 18" x 14"	<b>75458</b>	\$3,605.00	<b>3211814GS</b>	\$4,635.00
18" x 18" x 16"	<b>75459</b>	\$3,934.50	<b>3211816GS</b>	\$4,969.50
20" x 20" x 14"	<b>73581</b>	\$4,799.00	<b>3212114GS</b>	\$6,109.00
20" x 20" x 16"	<b>73582</b>	\$5,148.00	<b>3212116GS</b>	\$6,525.50
20" x 20" x 18"	<b>73583</b>	\$5,661.00	<b>3212118GS</b>	\$7,157.50
24" x 24" x 10"	<b>73584</b>	\$6,257.50	<b>73647</b>	\$7,864.50
24" x 24" x 12"	<b>73585</b>	\$6,433.50	<b>73648</b>	\$9,051.00
24" x 24" x 14"	<b>3212414S</b>	\$7,176.50	<b>73649</b>	\$9,838.50
24" x 24" x 16"	<b>73587</b>	\$7,337.50	<b>73650</b>	\$10,059.50
24" x 24" x 18"	<b>75460</b>	\$7,473.50	<b>73651</b>	\$10,266.50
24" x 24" x 20"	<b>3212420S</b>	\$8,113.50	<b>73652</b>	\$11,896.50

Tee is segmentally welded except where a \* indicates it is available as a cast fitting.

Orders for items in shaded areas **cannot** be cancelled or returned.

#### Technical Data Sheet: G180

### #323 Groove x Male Thread – Reducing Tee with Threaded Branch

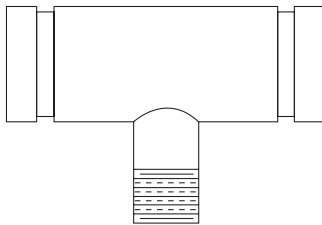

<i>Nominal Size</i>	<i>Painted</i>	<i>List Price</i>	<i>Galvanized</i>	<i>List Price</i>
1 1/2" x 1 1/2" x 1 1/4"	<b>73653</b>	POA	<b>3231513GS</b>	POA
2" x 2" x 1"	<b>75500</b>	\$293.00	<b>75520</b>	\$343.50
2" x 2" x 1 1/4"	<b>75409</b>	\$492.50	<b>3232013GS</b>	\$526.50
2" x 2" x 1 1/2"	<b>75501</b>	\$293.00	<b>75522</b>	\$348.50
2 1/2" x 2 1/2" x 1"	<b>76502</b>	\$293.00	<b>75408</b>	\$343.50
2 1/2" x 2 1/2" x 1 1/4"	<b>75502</b>	\$639.50	<b>73608</b>	\$657.50
2 1/2" x 2 1/2" x 1 1/2"	<b>75503</b>	\$293.00	<b>73609</b>	\$348.50
2 1/2" x 2 1/2" x 2"	<b>75504</b>	\$293.00	<b>73610</b>	\$351.00
3" x 3" x 1"	<b>75505</b>	\$293.00	<b>75521</b>	\$366.50
3" x 3" x 1 1/2"	<b>75506</b>	\$293.00	<b>75546</b>	\$368.50
3" x 3" x 2"	<b>75507</b>	\$293.00	<b>75523</b>	\$368.50
3" x 3" x 2 1/2"	<b>75508</b>	\$705.50	<b>73611</b>	\$763.50
4" x 4" x 1"	<b>75509</b>	\$366.50	<b>75524</b>	\$450.50
4" x 4" x 1 1/4"	<b>76541</b>	\$752.00	<b>3234013GS</b>	\$810.00
4" x 4" x 1 1/2"	<b>75541</b>	\$366.50	<b>76524</b>	\$458.50
4" x 4" x 2"	<b>75510</b>	\$366.50	<b>75525</b>	\$458.50
4" x 4" x 2 1/2"	<b>75511</b>	\$366.50	<b>73691</b>	\$472.00
4" x 4" x 3"	<b>75512</b>	\$366.50	<b>75526</b>	\$473.50
5" x 5" x 2"	<b>75513</b>	\$783.00	<b>75534</b>	\$853.00
5" x 5" x 2 1/2"	<b>76822</b>	\$703.50	<b>3235025GS</b>	\$891.00
5" x 5" x 3"	<b>3235030S</b>	\$651.00	<b>75535</b>	\$819.50
5" x 5" x 4"	<b>3235040S</b>	\$703.50	<b>3235040GS</b>	\$959.00

**#323 Groove x Male Thread – Reducing Tee with Threaded Branch**

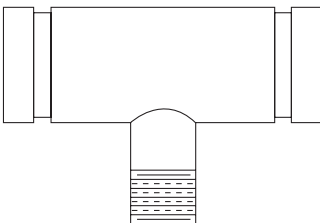
	<i>Nominal Size</i>	<i>Painted</i>	<i>List Price</i>	<i>Galvanized</i>	<i>List Price</i>
	 <p>(Continued from Previous page)</p>	6" x 6" x 2"	<b>75514</b>	\$913.50	<b>75527</b>
6" x 6" x 2 1/2"		<b>75590</b>	\$913.50	<b>75528</b>	\$1,137.00
6" x 6" x 3"		<b>75515</b>	\$913.50	<b>75529</b>	\$1,137.00
6" x 6" x 4"		<b>75516</b>	\$1,154.00	<b>73694</b>	\$1,241.00
6" x 6" x 5"		<b>75517</b>	\$913.50	<b>3236050GS</b>	\$1,137.00
8" x 8" x 2"		<b>75518</b>	\$1,117.50	<b>73696</b>	\$1,541.50
8" x 8" x 3"		<b>75519</b>	\$1,541.50	<b>3238030GS</b>	\$1,999.00
8" x 8" x 4"		<b>3238040S</b>	\$1,615.00	<b>3238040GS</b>	\$2,087.00
8" x 8" x 5"		<b>3238050S</b>	\$1,615.00	<b>3238050GS</b>	\$2,099.50
8" x 8" x 6"		<b>3238060S</b>	\$1,786.50	<b>3238060GS</b>	\$2,454.00
10" x 10" x 2"		<b>73659</b>	\$1,872.50	<b>3231020GS</b>	\$2,735.50
10" x 10" x 3"		<b>3231030S</b>	\$1,872.50	<b>3231030GS</b>	\$2,323.00
10" x 10" x 4"		<b>3231040S</b>	\$1,958.50	<b>3231040GS</b>	\$2,503.50
10" x 10" x 5"		<b>3231050S</b>	\$1,722.00	<b>3231050GS</b>	\$2,555.50
10" x 10" x 6"		<b>3231060S</b>	\$2,002.00	<b>3231060GS</b>	\$2,589.50
10" x 10" x 8"		<b>3231080S</b>	\$2,700.00	<b>3231080GS</b>	\$3,018.00
12" x 12" x 3"		<b>3231230S</b>	\$2,522.00	<b>3231230GS</b>	\$3,255.50
12" x 12" x 4"		<b>3231240S</b>	\$2,702.00	<b>3231240GS</b>	\$3,470.00
12" x 12" x 5"		<b>3231250S</b>	\$2,856.50	<b>3231250GS</b>	\$3,710.00
12" x 12" x 6"		<b>3231260S</b>	\$2,891.00	<b>3231260GS</b>	\$3,744.50
12" x 12" x 8"	<b>3231280S</b>	\$2,972.00	<b>3231280GS</b>	\$3,831.50	
12" x 12" x 10"	<b>3231210S</b>	\$3,110.50	<b>3231210GS</b>	\$3,837.00	

Tee is segmentally welded.

 Orders for items in shaded areas *cannot* be cancelled or returned.

**Technical Data Sheet: G180**

## Tyco Mechanical Products Section 2 – Couplings & Fittings



### #250 and #350 – Grooved Concentric Reducer

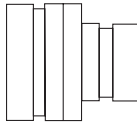

<i>Nominal Size</i>	<i>Painted</i>	<i>List Price</i>	<i>Galvanized</i>	<i>List Price</i>
1 1/4" x 1"	<b>3501301S</b>	\$399.00	<b>3501301GS</b>	\$439.00
1 1/2" x 1"	<b>74328</b>	\$100.00	<b>73400</b>	\$117.00
* 1 1/2" x 1 1/4"	<b>2501513S</b>	\$100.00	<b>2501513GS</b>	\$117.00
2" x 1"	<b>72852</b>	\$100.00	<b>73402</b>	\$117.00
2" x 1 1/4"	<b>72853</b>	\$108.50	<b>73403</b>	\$127.50
2" x 1 1/2"	<b>72854</b>	\$100.00	<b>73404</b>	\$117.00
2 1/2" x 1"	<b>72855</b>	\$135.00	<b>73393</b>	\$155.50
* 2 1/2" x 1 1/4"	<b>2502513S</b>	\$100.00	<b>2502513GS</b>	\$117.00
* 2 1/2" x 1 1/2"	<b>2502515S</b>	\$100.00	<b>2502515GS</b>	\$117.00
* 2 1/2" x 2"	<b>2502520S</b>	\$100.00	<b>2502520GS</b>	\$117.00
3" x 1"	<b>72860</b>	\$108.50	<b>73406</b>	\$132.50
3" x 1 1/4"	<b>72861</b>	\$173.50	<b>73396</b>	\$200.00
* 3 x 1 1/2"	<b>2503015S</b>	\$119.50	<b>2503015GS</b>	\$145.50
* 3" x 2"	<b>2503020S</b>	\$88.00	<b>2503020GS</b>	\$107.50
* 3" x 2 1/2"	<b>2503025S</b>	\$119.50	<b>2503025GS</b>	\$144.50
4" x 1"	<b>72867</b>	\$132.00	<b>73409</b>	\$161.50
4" x 1 1/4"	<b>72868</b>	\$1,004.50	<b>3504013GS</b>	\$1,125.50
4" x 1 1/2"	<b>72869</b>	\$181.50	<b>73410</b>	\$240.00
* 4" x 2"	<b>2504020S</b>	\$117.00	<b>2504020GS</b>	\$143.50
* 4" x 2 1/2"	<b>2504025S</b>	\$144.50	<b>2504025GS</b>	\$175.50
* 4" x 3"	<b>2504030S</b>	\$144.50	<b>2504030GS</b>	\$175.50
5" x 2"	<b>72876</b>	\$1,413.00	<b>73399</b>	\$1,560.50
5" x 2 1/2"	<b>72877</b>	\$293.00	<b>3505025GS</b>	\$357.50
* 5" x 3"	<b>2505030S</b>	\$167.00	<b>2505030GS</b>	\$207.00
* 5" x 4"	<b>2505040S</b>	\$199.00	<b>2505040GS</b>	\$249.00
* 6" x 2"	<b>2506020S</b>	\$263.50	<b>2506020GS</b>	\$328.50
* 6" x 2 1/2"	<b>2506025S</b>	\$293.00	<b>2506025GS</b>	\$360.00
* 6" x 3"	<b>2506030S</b>	\$263.50	<b>2506030GS</b>	\$328.50
* 6" x 4"	<b>2506040S</b>	\$231.00	<b>2506040GS</b>	\$298.00
* 6" x 5"	<b>2506050S</b>	\$340.00	<b>2506050GS</b>	\$421.50
8" x 2 1/2"	<b>73749</b>	POA	<b>73761</b>	POA
* 8" x 3"	<b>2508030S</b>	\$469.00	<b>2508030GS</b>	\$584.00
* 8" x 4"	<b>2508040S</b>	\$469.00	<b>2508040GS</b>	\$587.00
* 8" x 5"	<b>2508050S</b>	\$469.00	<b>2508050GS</b>	\$590.50
* 8" x 6"	<b>2508060S</b>	\$595.00	<b>2508060GS</b>	\$745.00
10" x 4"	<b>72889</b>	\$1,067.00	<b>73764</b>	\$1,314.00
10" x 5"	<b>73750</b>	\$2,348.00	<b>3501050GS</b>	\$2,679.00
* 10" x 6"	<b>2501060S</b>	\$1,167.50	<b>2501060GS</b>	\$1,455.00
* 10" x 8"	<b>2501080S</b>	\$1,167.50	<b>2501080GS</b>	\$1,480.00
* 12" x 4"	<b>2501240S</b>	\$5,108.50	<b>2501240GS</b>	\$6,080.00
* 12" x 6"	<b>2501260S</b>	\$1,392.00	<b>2501260GS</b>	\$1,720.50
* 12" x 8"	<b>2501280S</b>	\$2,088.00	<b>2501280GS</b>	\$2,465.50
* 12" x 10"	<b>2501210S</b>	\$2,088.00	<b>2501210GS</b>	\$2,584.50

Introduction  
Couplings & Fittings  
Mechanical Tees  
Valves  
Circuit Balancing Valves  
Accessories  
Copper Systems  
Stainless Steel Systems  
Plain End Systems  
Stainless Steel G-PRESS  
HDPE Systems  
Gaskets & Spare Parts  
Preparation Equipment  
Miscellaneous  
Indices

**#250 and #350 – Grooved Concentric Reducer**

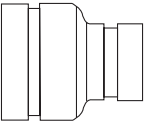
	<i>Nominal Size</i>	<i>Painted</i>	<i>List Price</i>	<i>Galvanized</i>	<i>List Price</i>
 (Continued from Previous Page)	14" x 6"	72897	\$4,761.00	3501460GS	\$5,160.50
	14" x 8"	72898	\$2,698.50	3501480GS	\$2,985.50
	14" x 10"	72899	\$2,358.50	73770	\$2,631.50
	14" x 12"	72900	\$2,581.50	73771	\$2,911.00
	16" x 8"	72901	\$3,865.50	3501680GS	\$4,215.00
	16" x 10"	72902	\$3,714.00	3501610GS	\$4,215.00
	16" x 12"	72903	\$3,764.00	73774	\$4,239.00
	16" x 14"	72904	\$3,764.00	3501614GS	\$4,291.00
	18" x 12"	72906	\$5,293.00	3501812GS	\$6,909.00
	18" x 14"	72910	\$4,285.50	3501814GS	\$5,399.50
	18" x 16"	72911	\$4,285.50	3501816GS	\$5,399.50
	20" x 10"	73751	\$6,185.00	73779	POA
	20" x 12"	72915	\$5,767.00	3502112GS	\$6,989.50
	20" x 14"	73752	\$5,790.50	3502114GS	\$7,003.00
	20" x 16"	73753	\$4,660.50	3502116GS	\$5,743.00
	20" x 18"	73754	\$4,486.50	3502118GS	\$7,689.00
	24" x 10"	72920	\$12,391.00	73784	POA
	24" x 12"	72921	\$13,527.00	73785	POA
	24" x 14"	72922	\$10,172.00	73786	\$15,117.50
	24" x 16"	72923	\$11,068.00	73787	\$16,037.00
	24" x 18"	72924	\$10,590.00	3502418GS	\$12,783.00
	24" x 20"	72925	\$8,521.50	3502421GS	\$10,725.50

Reducer is segmentally welded except where a \* indicates it is available as a cast fitting.

 Orders for items in shaded areas **cannot** be cancelled or returned.

**Technical Data Sheet: G180**
**#251 and #351 – Grooved Eccentric Reducer**

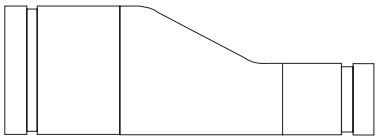
	<i>Nominal Size</i>	<i>Painted</i>	<i>List Price</i>	<i>Galvanized</i>	<i>List Price</i>
	1 1/2" x 1"	3511510S	\$421.00	3511510GS	\$492.50
	1 1/2" x 1 1/4"	73812	\$411.50	3511513GS	\$514.50
	2" x 1"	73815	\$464.00	3512010GS	\$492.00
	2" x 1 1/4"	73813	\$507.00	73846	POA
	2" x 1 1/2"	72930	\$103.50	3512015GS	\$123.00
	2 1/2" x 1"	3512510S	\$1,092.50	3512510GS	\$1,210.00
	2 1/2" x 1 1/4"	72931	\$110.50	3512513GS	\$128.00
	2 1/2" x 1 1/2"	72932	\$506.00	3512515GS	\$578.00
	2 1/2" x 2"	72933	\$207.00	73851	\$281.00
	3" x 1"	3513010S	\$1,172.50	3513010GS	\$1,290.50
	3" x 1 1/4"	73814	\$1,062.00	3513013GS	POA
	3" x 1 1/2"	76587	\$584.00	3513015GS	\$682.50
	* 3" x 2"	2513020S	\$236.00	2513020GS	\$322.50
	* 3" x 2 1/2"	2513025S	\$236.00	2513025GS	\$330.00
	4" x 1"	3514010S	\$2,373.50	3514010GS	POA
	4" x 1 1/4"	73817	POA	3514013GS	POA
	4" x 1 1/2"	73816	\$1,436.00	3514015GS	\$1,550.50
	* 4" x 2"	2514020S	\$288.00	2514020GS	\$401.50
	* 4" x 2 1/2"	2514025S	\$288.00	2514025GS	\$401.50
	* 4" x 3"	2514030S	\$288.00	2514030GS	\$288.50

## Tyco Mechanical Products Section 2 – Couplings & Fittings

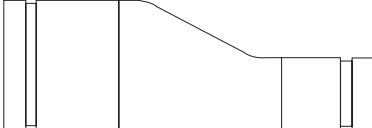

### #251 and #351 – Grooved Eccentric Reducer

	<i>Nominal Size</i>	<i>Painted</i>	<i>List Price</i>	<i>Galvanized</i>	<i>List Price</i>
	5" x 2"	<b>73818</b>	\$1,583.50	<b>73860</b>	\$1,822.50
	5" x 2 1/2"	<b>73819</b>	\$1,349.50	<b>73861</b>	POA
	5" x 3"	<b>72939</b>	\$1,304.50	<b>3515030GS</b>	\$1,453.50
	* 5" x 4"	<b>2515040S</b>	\$391.00	<b>2515040GS</b>	\$551.00
	6" x 2"	<b>73820</b>	\$2,242.50	<b>72963</b>	\$2,442.00
	6" x 2 1/2"	<b>72941</b>	\$2,669.50	<b>3516025GS</b>	\$2,906.00
	* 6" x 3"	<b>2516030S</b>	\$518.50	<b>2516030GS</b>	\$727.50
	* 6" x 4"	<b>2516040S</b>	\$455.00	<b>2516040GS</b>	\$667.50
	* 6" x 5"	<b>2516050S</b>	\$545.00	<b>2516050GS</b>	\$772.50
	8" x 3"	<b>72946</b>	\$2,604.00	<b>3518030GS</b>	\$2,836.50
	8" x 4"	<b>72947</b>	\$2,277.50	<b>3518040GS</b>	\$2,598.50
	8" x 5"	<b>72948</b>	\$2,277.50	<b>3518050GS</b>	\$2,598.50
	8" x 6"	<b>72949</b>	\$917.00	<b>3518060GS</b>	\$1,252.00
	10" x 4"	<b>72950</b>	\$4,020.50	<b>3511040GS</b>	\$4,821.50
	10" x 5"	<b>3511050S</b>	\$3,787.00	<b>3511050GS</b>	\$4,457.00
	10" x 6"	<b>72951</b>	\$2,856.50	<b>3511060GS</b>	\$3,386.00
	10" x 8"	<b>72952</b>	\$2,418.50	<b>73875</b>	\$3,007.50
	12" x 4"	<b>3511240S</b>	\$4,223.00	<b>3511240GS</b>	\$4,967.50
	12" x 5"	<b>3511250S</b>	POA	<b>3511250GS</b>	POA
	12" x 6"	<b>73823</b>	\$3,815.50	<b>73877</b>	\$4,595.50
	12" x 8"	<b>72953</b>	\$3,718.50	<b>73878</b>	\$4,449.50
	12" x 10"	<b>72954</b>	\$3,329.50	<b>3511210GS</b>	\$3,948.00
	14" x 6"	<b>3511460S</b>	\$5,814.00	<b>3511460GS</b>	\$6,919.50
	14" x 8"	<b>72955</b>	\$4,402.50	<b>3511480GS</b>	\$5,023.50
	14" x 10"	<b>73825</b>	\$4,027.00	<b>3511410GS</b>	\$4,404.00
	14" x 12"	<b>72956</b>	\$3,911.00	<b>73883</b>	\$4,278.00
	16" x 8"	<b>3511680S</b>	\$6,421.50	<b>73884</b>	\$7,064.00
	16" x 10"	<b>373828</b>	\$5,933.00	<b>73885</b>	\$6,823.00
	16" x 12"	<b>72958</b>	\$5,835.50	<b>3511612GS</b>	\$6,382.50
	16" x 14"	<b>73830</b>	\$5,711.50	<b>73887</b>	\$6,907.00
18" x 12"	<b>73831</b>	\$7,578.00	<b>73888</b>	\$8,714.50	
18" x 14"	<b>73832</b>	\$6,885.50	<b>3511814GS</b>	\$8,327.00	
18" x 16"	<b>73833</b>	\$6,885.50	<b>3511816GS</b>	\$8,688.50	
20" x 12"	<b>3512112S</b>	\$7,866.00	<b>73892</b>	POA	
20" x 14"	<b>73836</b>	\$8,082.50	<b>73893</b>	POA	
20" x 16"	<b>73837</b>	\$7,805.00	<b>3512116GS</b>	\$9,439.50	
20" x 18"	<b>73838</b>	\$7,805.00	<b>3512118GS</b>	\$9,850.00	
24" x 10"	<b>3512410S</b>	POA	<b>3512410GS</b>	POA	
24" x 12"	<b>73840</b>	\$10,452.00	<b>73897</b>	POA	
24" x 14"	<b>73841</b>	\$13,118.50	<b>73898</b>	POA	
24" x 16"	<b>73842</b>	\$13,118.50	<b>73899</b>	\$15,086.00	
24" x 18"	<b>73843</b>	\$12,373.50	<b>3512418GS</b>	\$14,588.00	
24" x 20"	<b>3512421S</b>	\$12,521.00	<b>3512421GS</b>	\$15,463.50	

(Continued from Previous Page)

Reducer is segmentally welded except where a \* indicates it is available as a cast fitting.

Orders for items in shaded areas **cannot** be cancelled or returned.

**Technical Data Sheet: G180**

Introduction  
Couplings & Fittings  
Mechanical Tees  
Valves  
Circuit Balancing Valves  
Accessories  
Copper Systems  
Stainless Steel Systems  
Plain End Systems  
Stainless Steel G-PRESS  
HDPE Systems  
Gaskets & Spare Parts  
Preparation Equipment  
Miscellaneous  
Indices

**#372 Groove x Male Thread – Reducer**

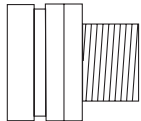
	<i>Nominal Size</i>	<i>Painted</i>	<i>List Price</i>	<i>Galvanized</i>	<i>List Price</i>
	1 1/2" x 1"	<b>76800</b>	\$103.50	<b>76825</b>	\$127.00
	2" x 3/4"	<b>76801</b>	\$103.50	<b>76826</b>	\$127.00
	2" x 1"	<b>76802</b>	\$103.50	<b>76827</b>	\$127.00
	2" x 1 1/4"	<b>76815</b>	\$103.50	<b>3722013GS</b>	\$127.00
	2" x 1 1/2"	<b>76803</b>	\$103.50	<b>76828</b>	\$127.00
	2 1/2" x 1 1/4"	<b>76816</b>	\$146.50	<b>3722513GS</b>	\$180.50
	2 1/2" x 1 1/2"	<b>76817</b>	\$153.50	<b>3722515GS</b>	\$180.50
	2 1/2" x 2"	<b>76804</b>	\$103.50	<b>76829</b>	\$127.00
	3" x 1"	<b>76805</b>	\$112.50	<b>76830</b>	\$135.50
	3" x 1 1/4"	<b>76818</b>	\$354.00	<b>3723013GS</b>	\$393.50
	3" x 1 1/2"	<b>76819</b>	\$127.00	<b>73797</b>	\$152.00
	3" x 2"	<b>76806</b>	\$127.00	<b>76831</b>	\$152.00
	3" x 2 1/2"	<b>76807</b>	\$153.50	<b>76832</b>	\$180.50
	4" x 1"	<b>76808</b>	\$145.00	<b>76833</b>	\$175.50
	4" x 1 1/4"	<b>76820</b>	POA	<b>3724013GS</b>	POA
	4" x 1 1/2"	<b>76821</b>	\$338.50	<b>73799</b>	\$442.50
	4" x 2"	<b>76809</b>	\$154.50	<b>76834</b>	\$184.50
	4" x 2 1/2"	<b>76810</b>	\$155.00	<b>76835</b>	\$190.00
	4" x 3"	<b>76811</b>	\$189.50	<b>76836</b>	\$224.00
	5" x 3"	<b>3725030S</b>	POA	<b>3725030GS</b>	POA
5" x 4"	<b>3725040S</b>	\$1,071.50	<b>3725040GS</b>	\$1,165.50	
6" x 1"	<b>76812</b>	\$293.00	<b>76837</b>	\$360.00	
6" x 2"	<b>76813</b>	\$293.00	<b>76838</b>	\$360.00	
6" x 3"	<b>76814</b>	\$293.00	<b>76839</b>	\$360.00	
6" x 4"	<b>73792</b>	\$1,759.00	<b>3726040GS</b>	\$1,948.50	
6" x 5"	<b>73793</b>	POA	<b>73802</b>	POA	

Reducer is segmentally welded.

 Orders for items in shaded areas **cannot** be cancelled or returned.

**Technical Data Sheet: G180**
**#391 Groove x Male Thread – Adapter Nipple**

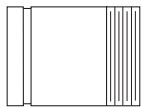
	<i>Nominal Size (O.D. x Length)</i>	<i>Painted</i>	<i>List Price</i>	<i>Galvanized</i>	<i>List Price</i>
	1 1/4" x 4" L	<b>75121</b>	\$51.50	<b>74292</b>	POA
	1 1/2" x 4" L	<b>75122</b>	\$51.50	<b>74293</b>	POA
	2" x 4" L	<b>75123</b>	\$51.50	<b>74294</b>	POA
	2 1/2" x 4" L	<b>75124</b>	\$59.50	<b>74295</b>	POA
	3" x 4" L	<b>75125</b>	\$72.50	<b>74296</b>	POA
	3" x 6" L	<b>74335</b>	\$117.00	<b>3913060GS</b>	POA
	4" x 6" L	<b>75126</b>	\$118.00	<b>74297</b>	POA
	5" x 6" L	<b>75129</b>	\$243.00	<b>3915060GS</b>	POA
	6" x 6" L	<b>75130</b>	\$311.50	<b>3916060GS</b>	POA
	8" x 6" L	<b>75131</b>	\$349.50	<b>74336</b>	POA
	10" x 8" L	<b>75132</b>	\$489.00	<b>74337</b>	POA
	12" x 8" L	<b>75133</b>	\$612.50	<b>74338</b>	POA

Adapter Nipple is segmentally welded.

 Orders for items in shaded areas **cannot** be cancelled or returned.

**Technical Data Sheet: G180**

**#392 Groove x Groove – Adapter Nipple**

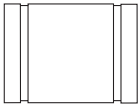
	Nominal Size (O.D. x Length)	Painted	List Price	Galvanized	List Price
	1 1/4" x 4" L	75098	\$51.50	74339	POA
	1 1/2" x 4" L	75099	\$51.50	3921540GS	POA
	2" x 4" L	75100	\$51.50	3922040GS	POA
	2 1/2" x 4" L	75101	\$59.50	3922540GS	POA
	3" x 4" L	75102	\$72.50	3923040GS	POA
	4" x 6" L	75103	\$118.00	74309	POA
	5" x 6" L	75104	\$243.00	3925060GS	POA
	6" x 6" L	75105	\$311.50	74311	POA
	8" x 6" L	75106	\$349.50	3928060GS	POA
	10" x 8" L	75107	\$489.00	3921080GS	POA
12" x 8" L	75108	\$612.50	3921280GS	POA	

Adapter Nipple is segmentally welded.  
Orders for items in shaded areas **cannot** be cancelled or returned.  
**Technical Data Sheet: G180**

**#393 Groove x Beveled – Adapter Nipple**

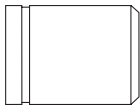
	Nominal Size (O.D. x Length)	Painted	List Price	Galvanized	List Price
	1 1/4" x 4" L	75148	\$51.50	3931340GS	POA
	1 1/2" x 4" L	3931540S	\$51.50	3931540GS	POA
	2" x 4" L	75150	\$51.50	3932040GS	POA
	2 1/2" x 4" L	75151	\$59.50	3932540GS	POA
	3" x 4" L	75152	\$72.50	74330	POA
	4" x 6" L	75153	\$118.00	74331	POA
	5" x 6" L	75158	\$243.00	3935060GS	POA
	6" x 6" L	75154	\$311.50	3936060GS	POA
	8" x 6" L	75155	\$349.50	3938060GS	POA
	10" x 8" L	75156	\$489.00	3931080GS	POA
12" x 8" L	75157	\$612.50	3931280GS	POA	

Adapter Nipple is segmentally welded.  
Orders for items in shaded areas **cannot** be cancelled or returned.  
**Technical Data Sheet: G180**

**#395 Hose Adapter Nipple, Groove x Hose**

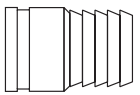
	Nominal Size (O.D. x Length)	Painted	List Price	Galvanized	List Price
	1" x 3 1/4" L	72680	\$168.50	72692	POA
	1 1/4" x 3 5/8" L	72681	\$168.50	72693	POA
	1 1/2" x 4" L	72682	\$168.50	72694	\$201.00
	2" x 4 5/8" L	72683	\$168.50	72695	\$201.00
	2 1/2" x 5 1/2" L	72684	\$168.50	72696	\$201.00
	3" x 6" L	72685	\$243.00	72697	\$292.50
	4" x 7 1/4" L	72686	\$421.00	72698	\$506.50
	5" x 9 3/4" L	72687	\$635.50	72699	POA
	6" x 11" L	72688	\$754.50	72620	POA
	8" x 12 1/2" L	39580125S	\$1,567.00	39580125GS	POA
	10" x 14" L	3951014S	\$1,539.50	72622	POA
	12" x 16" L	72691	POA	72623	POA

Adapter Nipple is segmentally welded.  
Orders for items in shaded areas **cannot** be cancelled or returned.  
**Technical Data Sheet: G180**

Introduction  
Couplings & Fittings  
Mechanical Tees  
Valves  
Circuit Balancing Valves  
Accessories  
Copper Systems  
Stainless Steel Systems  
Plain End Systems  
Stainless Steel G-PRESS  
HDPE Systems  
Gaskets & Spare Parts  
Preparation Equipment  
Miscellaneous  
Indices

**#380 Female Thread Adapter, Groove x Female Pipe Thread**

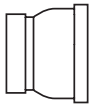
	Nominal Size	Painted	List Price	Galvanized	List Price
	1"	72601	\$469.00	72607	\$503.00
	1 1/4"	72602	\$248.00	72608	\$277.50
	1 1/2"	72603	\$321.00	72609	\$342.00
	2"	72604	\$152.00	72610	\$178.00
	2 1/2"	72613	\$152.00	72614	\$178.00
	3"	72605	\$176.00	72611	\$215.00
	4"	72606	\$269.00	72612	\$337.50

Adapter is segmentally welded.

 Orders for items in shaded areas **cannot** be cancelled or returned.

**Technical Data Sheet: G180**
**#314 Grooved Lateral**

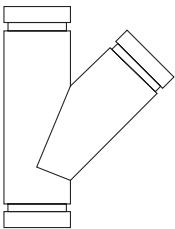
	Nominal Size	Painted	List Price	Galvanized	List Price
	1 1/4"	31413S	\$506.50	31413GS	POA
	1 1/2"	31415S	POA	31415GS	POA
	2"	75700	\$506.50	74700	\$620.00
	2 1/2"	75701	\$506.50	74701	\$620.00
	3"	75702	\$559.00	74702	\$704.50
	4"	75703	\$860.00	74703	\$1,071.50
	5"	31450S	\$1,256.00	31405GS	\$1,576.50
	6"	75704	\$2,021.50	74704	\$2,428.00
	8"	75705	\$2,909.00	74705	\$3,525.50
	10"	75706	\$3,952.50	31410GS	\$4,584.50
	12"	75707	\$4,777.50	31412GS	\$6,054.00
	14"	75708	\$4,229.50	31414GS	\$5,426.50
	16"	31416S	\$5,283.00	31416GS	\$6,785.50
	18"	75710	\$5,905.50	31418GS	\$7,676.50
	20"	75711	\$8,957.00	31421GS	\$11,350.00
	24"	75712	\$13,917.50	31424GS	\$16,217.00

Lateral is segmentally welded.

 Orders for items in shaded areas **cannot** be cancelled or returned.

**Technical Data Sheet: G180**



# Tyco Mechanical Products

## Section 2 – Couplings & Fittings



### #325 Grooved Reducing Lateral

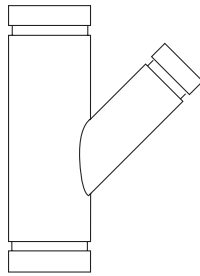

<i>Nominal Size</i>	<i>Painted</i>	<i>List Price</i>	<i>Galvanized</i>	<i>List Price</i>
3" x 3" x 2"	75670	\$438.50	3253020GS	\$547.00
3" x 3" x 2 1/2"	75671	\$438.50	75695	POA
4" x 4" x 2"	75672	\$860.00	74672	\$1,024.50
4" x 4" x 2 1/2"	75673	\$860.00	74673	\$1,061.00
4" x 4" x 3"	75674	\$860.00	3254030GS	\$1,070.00
5" x 5" x 2"	75675	\$1,256.00	74675	POA
5" x 5" x 2 1/2"	3255025S	POA	73935	POA
5" x 5" x 3"	75676	\$1,256.00	74676	\$1,557.50
5" x 5" x 4"	75677	\$1,256.00	74677	\$1,582.50
6" x 6" x 2"	75678	POA	74678	POA
6" x 6" x 2 1/2"	3256025S	POA	3256025GS	POA
6" x 6" x 3"	75679	\$1,621.00	74679	\$2,028.00
6" x 6" x 4"	75680	\$1,621.00	74680	\$2,042.00
6" x 6" x 5"	75681	\$1,621.00	74681	\$2,064.00
8" x 8" x 4"	75682	\$2,338.50	74682	\$2,968.00
8" x 8" x 5"	75683	\$2,338.50	74683	\$2,994.50
8" x 8" x 6"	75684	\$2,338.50	74684	\$3,031.00
10" x 10" x 4"	75685	\$2,559.00	74685	\$3,362.00
10" x 10" x 5"	75686	POA	74686	\$3,596.00
10" x 10" x 6"	75687	\$2,807.00	74687	\$3,586.00
10" x 10" x 8"	75688	\$2,859.00	74688	\$3,816.00
12" x 12" x 4"	75689	POA	74689	POA
12" x 12" x 6"	75690	\$3,317.50	74690	\$4,729.50
12" x 12" x 8"	75691	\$3,360.00	74691	\$4,539.00
12" x 12" x 10"	75692	\$3,404.50	74692	\$4,687.50
14" x 14" x 4"	73913	\$1,868.00	73937	\$2,810.50
14" x 14" x 6"	73914	\$2,005.50	3251460GS	\$2,999.00
14" x 14" x 8"	73915	\$2,157.00	3251480GS	\$3,392.50
14" x 14" x 10"	73916	\$2,734.00	3251410GS	\$3,582.50
14" x 14" x 12"	73917	\$2,775.00	3251412GS	\$3,976.50
16" x 16" x 6"	73918	\$2,907.00	3251660GS	\$4,136.50
16" x 16" x 8"	73919	\$3,074.00	3251680GS	\$4,947.50
16" x 16" x 10"	73920	\$3,587.50	3251610GS	\$4,895.50
16" x 16" x 12"	73921	\$3,739.00	3251612GS	\$5,250.50
16" x 16" x 14"	73922	\$3,739.00	3251614GS	\$5,250.50
18" x 18" x 6"	73923	\$3,739.00	3251860GS	\$5,250.50
18" x 18" x 8"	73924	\$3,739.00	3251880GS	\$5,250.50
18" x 18" x 10"	73925	POA	73949	POA
18" x 18" x 12"	73926	\$4,155.50	73950	\$5,874.50
18" x 18" x 14"	73927	\$4,974.50	3251814GS	\$6,469.50
18" x 18" x 16"	73928	\$5,595.50	3251816GS	\$7,228.00
20" x 20" x 12"	73929	\$5,347.50	3252112GS	\$7,636.50
20" x 20" x 14"	73930	\$5,512.50	3252114GS	\$7,870.00
20" x 20" x 16"	73931	\$6,502.50	3252116GS	\$9,038.50
24" x 24" x 16"	73932	\$12,343.00	74327	\$15,894.00
24" x 24" x 20"	73933	\$13,427.00	3252421GS	\$16,419.50

Lateral is segmentally welded.

Orders for items in shaded areas **cannot** be cancelled or returned.

**Technical Data Sheet: G180**

Introduction  
Couplings & Fittings  
Mechanical Tees  
Valves  
Circuit Balancing Valves  
Accessories  
Copper Systems  
Stainless Steel Systems  
Plain End Systems  
Stainless Steel G-PRESS  
HDPE Systems  
Gaskets & Spare Parts  
Preparation Equipment  
Miscellaneous  
Indices

**#324 Grooved Wye**

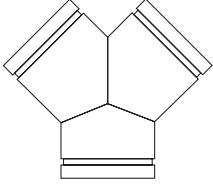
	<i>Nominal Size</i>	<i>Painted</i>	<i>List Price</i>	<i>Galvanized</i>	<i>List Price</i>
	1 1/4"	75901	\$485.50	74224	POA
	1 1/2"	75902	\$485.50	32415GS	\$578.00
	2"	75903	\$485.50	74226	\$578.00
	2 1/2"	75904	\$485.50	32425GS	\$578.00
	3"	75905	\$580.50	74228	\$690.50
	4"	75906	\$760.50	74229	\$914.00
	5"	75907	\$1,088.00	32450GS	\$1,306.00
	6"	75908	\$1,342.50	74231	\$1,635.50
	8"	75909	\$1,933.50	32480GS	\$2,376.00
	10"	75910	\$3,210.50	74233	\$3,933.00
	12"	75911	\$3,546.00	74234	\$4,485.50
	14"	75912	\$2,585.50	32414GS	\$3,227.00
	16"	75913	\$3,593.50	32416GS	\$4,291.00
	18"	75914	\$4,190.00	32418GS	\$5,115.50
	20"	75915	\$5,606.50	32421GS	\$6,938.50
24"	75916	\$9,997.50	32424GS	\$10,535.00	

Wye is segmentally welded.

 Orders for items in shaded areas **cannot** be cancelled or returned.

**Technical Data Sheet: G180**
**#331 Grooved Reducing Tee Wye**

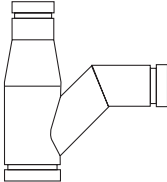
	<i>Nominal Size</i>	<i>Painted</i>	<i>List Price</i>	<i>Galvanized</i>	<i>List Price</i>
	4" x 3" x 3"	3314030S	\$1,301.00	3314030GS	\$1,547.00
	4" x 3" x 4"	75734	\$1,850.00	74214	\$2,216.00
	5" x 3" x 3"	3315030S	\$1,757.00	3315030GS	\$2,062.00
	5" x 3" x 5"	75736	POA	331503050GS	POA
	5" x 4" x 3"	74208	POA	74217	POA
	5" x 4" x 4"	75737	POA	74218	POA
	6" x 4" x 6"	74209	\$6,596.00	74219	POA
	6" x 5" x 3"	74210	POA	74220	POA
	6" x 5" x 4"	74211	POA	74221	POA
	8" x 6" x 4"	74212	POA	74222	\$4,134.00
	8" x 6" x 8"	75746	\$7,728.00	74223	\$8,509.00

Wye is segmentally welded.

 Orders for items in shaded areas **cannot** be cancelled or returned.

**Technical Data Sheet: G180**

## Tyco Mechanical Products Section 2 – Couplings & Fittings



### #330 Grooved Tee Wye

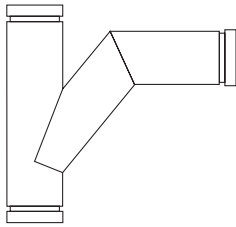

	Nominal Size	Painted	List Price	Galvanized	List Price
	2" x 2" x 2"	75730	\$880.50	3302020GS	\$1,048.50
	2 1/2" x 2 1/2" x 2 1/2"	75731	\$880.50	3302525GS	\$1,048.50
	3" x 3" x 3"	75732	\$1,009.50	73979	\$1,218.00
	4" x 4" x 3"	73957	\$1,216.00	73980	\$1,471.50
	4" x 4" x 4"	75735	\$1,401.00	73981	\$1,703.50
	5" x 5" x 3"	3305030S	\$1,759.50	3305030GS	\$2,062.50
	5" x 5" x 4"	3305040S	\$2,028.00	73983	\$2,264.50
	5" x 5" x 5"	75738	\$2,980.00	3305050GS	\$3,640.00
	6" x 6" x 3"	3306030S	\$1,441.50	3306030GS	\$1,860.50
	6" x 6" x 4"	3306040S	\$1,756.50	73986	\$2,195.00
	6" x 6" x 5"	73962	POA	73987	POA
	6" x 6" x 6"	75742	\$2,671.50	73988	\$3,303.50
	8" x 8" x 3"	3308030S	\$1,716.50	73989	\$2,492.50
	8" x 8" x 4"	3308040S	\$2,044.50	73990	\$2,817.50
	8" x 8" x 5"	3308050S	\$2,706.00	3308050GS	\$3,559.00
	8" x 8" x 6"	3308060S	\$2,951.00	73992	\$3,859.00
	8" x 8" x 8"	75759	\$4,066.00	73993	\$5,155.00
	10" x 10" x 3"	3301030S	\$2,276.50	3301030GS	\$3,156.00
	10" x 10" x 4"	3301040S	\$2,496.50	73995	\$3,428.00
	10" x 10" x 5"	73969	POA	73996	\$4,181.50
	10" x 10" x 6"	73970	\$3,311.00	73997	\$4,392.50
	10" x 10" x 8"	73971	\$4,295.50	73998	\$5,526.00
	10" x 10" x 10"	75752	\$5,610.00	3301010GS	\$7,193.00
	12" x 12" x 3"	73972	POA	3301230GS	POA
	12" x 12" x 4"	73973	POA	72032	POA
	12" x 12" x 6"	3301260S	POA	3301260GS	POA
	12" x 12" x 8"	3301280S	POA	3301280GS	POA
	12" x 12" x 10"	3301210S	POA	72035	POA
	12" x 12" x 12"	75758	\$7,734.50	3301212GS	\$9,820.50

Wye is segmentally welded.

Orders for items in shaded areas *cannot* be cancelled or returned.

**Technical Data Sheet: G180**

Introduction  
Couplings & Fittings  
Mechanical Tees  
Valves  
Circuit Balancing Valves  
Accessories  
Copper Systems  
Stainless Steel Systems  
Plain End Systems  
Stainless Steel G-PRESS  
HDPE Systems  
Gaskets & Spare Parts  
Preparation Equipment  
Miscellaneous  
Indices

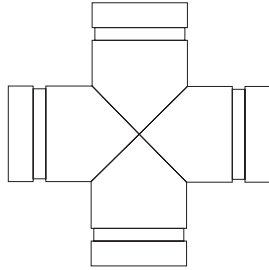
**#327 – Grooved Cross**

<i>Nominal Size</i>	<i>Painted</i>	<i>List Price</i>	<i>Galvanized</i>	<i>List Price</i>
1 1/4"	<b>32713S</b>	\$381.50	<b>32713GS</b>	\$444.00
1 1/2"	<b>73729</b>	\$410.50	<b>32715GS</b>	\$476.00
2"	<b>75840</b>	\$234.50	<b>75849</b>	\$279.50
2 1/2"	<b>75841</b>	\$234.50	<b>75850</b>	\$279.50
3"	<b>75842</b>	\$417.00	<b>75851</b>	\$510.50
4"	<b>75843</b>	\$691.50	<b>75852</b>	\$850.50
5"	<b>73730</b>	\$1,409.00	<b>32750GS</b>	\$1,698.00
6"	<b>75845</b>	\$1,808.00	<b>75853</b>	\$2,194.50
8"	<b>75846</b>	\$2,382.00	<b>76757</b>	\$2,946.50
10"	<b>75847</b>	\$3,907.00	<b>76758</b>	\$4,833.00
12"	<b>75848</b>	\$5,638.00	<b>76759</b>	\$7,023.50
14"	<b>32714S</b>	\$3,741.50	<b>32714GS</b>	\$5,120.00
16"	<b>32716S</b>	\$5,394.50	<b>73743</b>	\$6,227.00
18"	<b>32718S</b>	\$6,580.00	<b>32718GS</b>	\$7,604.00
20"	<b>32721S</b>	\$7,853.00	<b>32721GS</b>	\$11,290.50
24"	<b>32724S</b>	\$11,408.50	<b>32724GS</b>	\$15,922.50

Cross is segmentally welded.

 Orders for items in shaded areas **cannot** be cancelled or returned.

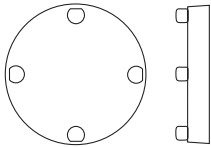
**Technical Data Sheet: G180**
**#260 and #360 – Grooved Cap**

<i>Nominal Size</i>	<i>Painted</i>	<i>List Price</i>	<i>Galvanized</i>	<i>List Price</i>
1" *	<b>26001S</b>	\$72.50	<b>26001GS</b>	\$86.00
1 1/4" *	<b>26013S</b>	\$72.50	<b>26013GS</b>	\$86.00
1 1/2" *	<b>26015S</b>	\$72.50	<b>26015GS</b>	\$86.00
2" *	<b>26020S</b>	\$72.50	<b>26020GS</b>	\$86.00
2 1/2" *	<b>26025S</b>	\$72.50	<b>26025GS</b>	\$86.00
3" *	<b>26030S</b>	\$72.50	<b>26030GS</b>	\$86.00
4" *	<b>26040S</b>	\$77.50	<b>26040GS</b>	\$101.50
5" *	<b>26050S</b>	\$180.50	<b>26050GS</b>	\$241.50
6" *	<b>26060S</b>	\$180.00	<b>26060GS</b>	\$241.50
8" *	<b>26080S</b>	\$343.00	<b>26080GS</b>	\$454.50
10" *	<b>26010S</b>	\$696.50	<b>26010GS</b>	\$907.50
12" *	<b>26012S</b>	\$1,138.00	<b>26012GS</b>	\$1,449.00
14"	<b>73807</b>	\$1,479.00	<b>75488</b>	\$1,692.50
16"	<b>73803</b>	\$1,673.50	<b>73808</b>	\$1,998.50
18"	<b>73804</b>	\$1,937.00	<b>73809</b>	\$2,289.00
20"	<b>73805</b>	\$2,200.00	<b>73810</b>	\$2,627.50
24"	<b>73806</b>	\$2,995.50	<b>73811</b>	\$3,464.00

Cap is segmentally welded except where a \* indicates it is available as a cast fitting.

 Orders for items in shaded areas **cannot** be cancelled or returned.

**Technical Data Sheet: G180**

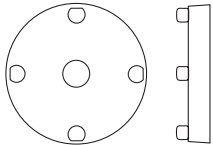
<b>#260 Cast – Grooved Cap with 1/2" Tap</b>			
	<i>Nominal Size</i>	<i>Painted</i>	<i>List Price</i>
	1 1/4"	26013TS	POA
	1 1/2"	26015TS	POA
	2"	26020TS	\$371.50
	2 1/2"	26025TS	\$376.00
	3"	26030TS	\$376.00
	4"	26040TS	\$382.00
	5"	26050TS	POA
	6"	26060TS	\$525.50
	8"	26080TS	\$774.50
	10"	26010TS	POA
	12"	26012TS	POA

Orders for items in shaded areas *cannot* be cancelled or returned.

**Technical Data Sheet: G180**

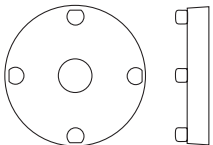
<b>#260 Cast – Grooved Cap with 3/4" Tap</b>			
	<i>Nominal Size</i>	<i>Painted</i>	<i>List Price</i>
	2"	26020T75S	\$370.50
	2 1/2"	26025T75S	POA
	3"	26030T75S	POA
	4"	26040T75S	POA
	5"	26050T75S	POA
	6"	26060T75S	\$524.00
	8"	26080T75S	\$626.50
	10"	26010T75S	\$1,201.50
	12"	26012T75S	\$1,390.50

Orders for items in shaded areas *cannot* be cancelled or returned.

**Technical Data Sheet: G180**

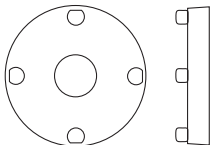
<b>#260 Cast – Grooved Cap with 1" Tap</b>			
	<i>Nominal Size</i>	<i>Painted</i>	<i>List Price</i>
	2"	26020T1S	\$371.50
	2 1/2"	26025T1S	POA
	3"	26030T1S	\$495.50
	4"	26040T1S	\$477.50
	5"	26050T1S	POA
	6"	26060T1S	\$525.50
	8"	26080T1S	\$628.00
	10"	26010T1S	POA
	12"	26012T1S	POA

Orders for items in shaded areas *cannot* be cancelled or returned.

**Technical Data Sheet: G180**

Introduction  
Couplings & Fittings  
Mechanical Tees  
Valves  
Circuit Balancing Valves  
Accessories  
Copper Systems  
Stainless Steel Systems  
Plain End Systems  
Stainless Steel G-PRESS  
HDPE Systems  
Gaskets & Spare Parts  
Preparation Equipment  
Miscellaneous  
Indices

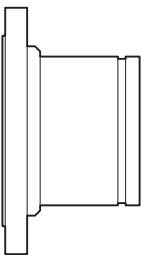
**#341 Groove x Flange – Adapter 150#**

<i>Nominal Size</i>	<i>Painted</i>	<i>List Price</i>	<i>Galvanized</i>	<i>List Price</i>
1¼"	74240	POA	74245	POA
1½"	74241	\$358.00	34115GS	\$563.00
2"	73230	\$358.00	34120GS	\$563.00
2½"	73231	\$714.00	73251	\$841.00
3"	73232	\$731.00	73252	\$868.50
4"	73233	\$833.00	73253	\$1,214.00
5"	73234	\$1,153.00	73254	\$1,596.00
6"	73235	\$1,173.50	73255	\$1,619.00
8"	73236	\$1,452.50	73256	\$2,161.50
10"	73237	\$2,193.50	74265	\$3,288.00
12"	73238	\$3,002.50	74254	\$4,335.00
14"	73239	\$3,994.00	34114GS	\$4,442.50
16"	73240	\$4,759.50	34116GS	\$5,525.50
18"	73241	\$5,269.00	34118GS	\$5,736.00
20"	73242	\$5,527.00	34121GS	\$5,980.50
24"	73243	\$5,787.00	74259	\$6,226.00

Adapter is segmentally welded.

Raised face flanges are standard; flat flanges are quoted on application.

 Orders for items in shaded areas *cannot* be cancelled or returned.

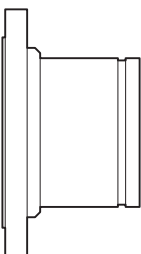
**Technical Data Sheet: G180**
**#342 Groove x Flange – Adapter 300#**

<i>Nominal Size</i>	<i>Painted</i>	<i>List Price</i>	<i>Galvanized</i>	<i>List Price</i>
1¼"	74260	POA	74276	\$516.50
1½"	34215S	\$411.50	34215GS	POA
2"	34220S	\$439.00	74278	\$516.50
2½"	74263	\$439.00	34225GS	\$516.50
3"	74264	\$609.00	34230GS	\$770.50
4"	73260	\$1,146.00	34240GS	\$1,310.50
5"	73261	\$1,173.50	73264	POA
6"	73262	\$1,173.50	74283	\$1,771.50
8"	74268	\$2,399.50	34280GS	\$2,853.00
10"	34210S	\$2,973.00	34210GS	POA
12"	34212S	\$4,462.50	34212GS	\$7,857.00
14"	34214S	POA	34214GS	POA
16"	34216S	POA	34216GS	POA
18"	34218S	POA	34218GS	POA
20"	34221S	POA	34221GS	POA
24"	34224S	POA	34224GS	POA

Adapter is segmentally welded.

Raised face flanges are standard; flat flanges are quoted on application.

 Orders for items in shaded areas *cannot* be cancelled or returned.

**Technical Data Sheet: G180**

## Tyco Mechanical Products Section 2 – Couplings & Fittings



### #397 Groove x Groove – Swaged Nipple

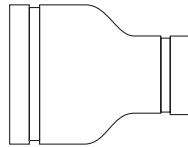

<i>Nominal Size</i>	<i>Painted</i>	<i>List Price</i>
2" x 1"	76840	\$368.00
2" x 1 <sup>1</sup> / <sub>4</sub> "	76841	\$368.00
2" x 1 <sup>1</sup> / <sub>2</sub> "	76842	\$368.00
2 <sup>1</sup> / <sub>2</sub> " x 1"	76843	\$791.50
2 <sup>1</sup> / <sub>2</sub> " x 1 <sup>1</sup> / <sub>4</sub> "	76844	\$791.50
2 <sup>1</sup> / <sub>2</sub> " x 1 <sup>1</sup> / <sub>2</sub> "	76845	\$791.50
2 <sup>1</sup> / <sub>2</sub> " x 2"	76846	\$703.00
3" x 1"	76847	\$882.00
3" x 1 <sup>1</sup> / <sub>4</sub> "	76848	\$882.00
3" x 1 <sup>1</sup> / <sub>2</sub> "	76849	\$882.00
3" x 2"	76850	\$741.00
3" x 2 <sup>1</sup> / <sub>2</sub> "	76851	\$741.00
3 <sup>1</sup> / <sub>2</sub> " x 3"	76852	\$1,693.50
4" x 1"	76853	\$1,253.50
4" x 1 <sup>1</sup> / <sub>4</sub> "	76854	\$1,253.50
4" x 1 <sup>1</sup> / <sub>2</sub> "	76855	\$961.00
4" x 2"	76856	\$961.00
4" x 2 <sup>1</sup> / <sub>2</sub> "	76857	\$1,101.00
4" x 3"	76858	\$1,101.00
5" x 1 <sup>1</sup> / <sub>2</sub> "	3975015S	POA
5" x 2"	76860	\$1,558.50
5" x 2 <sup>1</sup> / <sub>2</sub> "	3975025S	POA
5" x 3"	76861	\$1,558.50
5" x 4"	76862	\$1,558.50
6" x 1"	76863	\$3,107.00
6" x 1 <sup>1</sup> / <sub>4</sub> "	76864	\$3,107.00
6" x 1 <sup>1</sup> / <sub>2</sub> "	76865	\$3,107.00
6" x 2"	76866	\$2,541.50
6" x 2 <sup>1</sup> / <sub>2</sub> "	76867	\$2,541.50
6" x 3"	76868	\$2,541.50
6" x 4"	76870	\$1,522.50
6" x 5"	76871	\$1,522.50
8" x 6"	3978060S	\$2,899.50

Nipple is segmentally welded.

Orders for items in shaded areas **cannot** be cancelled or returned.

#### Technical Data Sheet: G180

Introduction
Couplings & Fittings
Mechanical Tees
Valves
Circuit Balancing Valves
Accessories
Copper Systems
Stainless Steel Systems
Plain End Systems
Stainless Steel G-PRESS
HDPE Systems
Gaskets & Spare Parts
Preparation Equipment
Miscellaneous
Indices

**#398 Groove x Male Thread – Swaged Nipple**

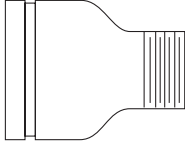
	<i>Nominal Size</i>	<i>Painted</i>	<i>List Price</i>
	2" x 1"	77001	\$368.00
	2" x 1 <sup>1</sup> / <sub>4</sub> "	77002	\$368.00
	2" x 1 <sup>1</sup> / <sub>2</sub> "	77003	\$368.00
	2 <sup>1</sup> / <sub>2</sub> " x 1"	77004	\$791.50
	2 <sup>1</sup> / <sub>2</sub> " x 1 <sup>1</sup> / <sub>4</sub> "	77005	\$791.50
	2 <sup>1</sup> / <sub>2</sub> " x 1 <sup>1</sup> / <sub>2</sub> "	77006	\$791.50
	2 <sup>1</sup> / <sub>2</sub> " x 2"	77007	\$703.00
	3" x 1"	77008	\$882.00
	3" x 1 <sup>1</sup> / <sub>4</sub> "	77009	\$882.00
	3" x 1 <sup>1</sup> / <sub>2</sub> "	77010	\$882.00
	3" x 2"	77011	\$741.00
	3" x 2 <sup>1</sup> / <sub>2</sub> "	77012	\$741.00
	3 <sup>1</sup> / <sub>2</sub> " x 3"	77013	\$1,693.50
	4" x 1"	77014	\$1,253.50
	4" x 1 <sup>1</sup> / <sub>4</sub> "	77015	\$1,253.50
	4" x 1 <sup>1</sup> / <sub>2</sub> "	77016	\$961.00
	4" x 2"	77017	\$961.00
	4" x 2 <sup>1</sup> / <sub>2</sub> "	77018	\$1,101.00
	4" x 3"	77019	\$1,101.00
	5" x 1 <sup>1</sup> / <sub>2</sub> "	3985015S	POA
	5" x 2"	77021	\$1,558.50
	5" x 2 <sup>1</sup> / <sub>2</sub> "	3985025S	POA
	5" x 3"	77022	\$1,558.50
	5" x 4"	77023	\$1,558.50
	6" x 1"	77024	\$3,107.00
	6" x 1 <sup>1</sup> / <sub>4</sub> "	77025	\$3,107.00
	6" x 1 <sup>1</sup> / <sub>2</sub> "	77026	\$3,107.00
	6" x 2"	77027	\$2,541.50
	6" x 2 <sup>1</sup> / <sub>2</sub> "	77028	\$2,541.50
	6" x 3"	77029	\$2,541.50
6" x 4"	77031	\$1,522.50	
6" x 5"	77032	\$1,522.50	
8" x 6"	3988060S	\$2,899.50	

Nipple is segmentally welded.

 Orders for items in shaded areas **cannot** be cancelled or returned.

**Technical Data Sheet: G180**



# Tyco Mechanical Products

## Section 2 – Couplings & Fittings



### #399 Groove x Plain – Swaged Nipple

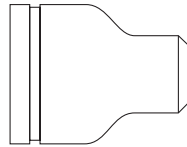

Nominal Size	Painted	List Price
2" x 1"	<b>76051</b>	\$368.00
2" x 1 <sup>1</sup> / <sub>4</sub> "	<b>76052</b>	\$368.00
2" x 1 <sup>1</sup> / <sub>2</sub> "	<b>76053</b>	\$368.00
2 <sup>1</sup> / <sub>2</sub> " x 1"	<b>76054</b>	\$791.50
2 <sup>1</sup> / <sub>2</sub> " x 1 <sup>1</sup> / <sub>4</sub> "	<b>76055</b>	\$791.50
2 <sup>1</sup> / <sub>2</sub> " x 1 <sup>1</sup> / <sub>2</sub> "	<b>76056</b>	\$791.50
2 <sup>1</sup> / <sub>2</sub> " x 2"	<b>76057</b>	\$703.00
3" x 1"	<b>76058</b>	\$882.00
3" x 1 <sup>1</sup> / <sub>4</sub> "	<b>76059</b>	\$882.00
3" x 1 <sup>1</sup> / <sub>2</sub> "	<b>76060</b>	\$882.00
3" x 2"	<b>76061</b>	\$741.00
3" x 2 <sup>1</sup> / <sub>2</sub> "	<b>76062</b>	\$741.00
3 <sup>1</sup> / <sub>2</sub> " x 3"	<b>76063</b>	\$1,693.50
4" x 1"	<b>76064</b>	\$1,253.50
4" x 1 <sup>1</sup> / <sub>4</sub> "	<b>76065</b>	\$1,253.50
4" x 1 <sup>1</sup> / <sub>2</sub> "	<b>76066</b>	\$961.00
4" x 2"	<b>76067</b>	\$961.00
4" x 2 <sup>1</sup> / <sub>2</sub> "	<b>76068</b>	\$1,101.00
4" x 3"	<b>76069</b>	\$1,101.00
5" x 1 <sup>1</sup> / <sub>2</sub> "	<b>3995015S</b>	POA
5" x 2"	<b>76071</b>	\$1,558.50
5" x 2 <sup>1</sup> / <sub>2</sub> "	<b>3995025S</b>	POA
5" x 3"	<b>76072</b>	\$1,558.50
5" x 4"	<b>76073</b>	\$1,558.50
6" x 1"	<b>76074</b>	\$3,107.00
6" x 1 <sup>1</sup> / <sub>4</sub> "	<b>76075</b>	\$3,107.00
6" x 1 <sup>1</sup> / <sub>2</sub> "	<b>76076</b>	\$3,107.00
6" x 2"	<b>76077</b>	\$2,541.50
6" x 2 <sup>1</sup> / <sub>2</sub> "	<b>76078</b>	\$2,541.50
6" x 3"	<b>76079</b>	\$2,541.50
6" x 4"	<b>76081</b>	\$1,522.50
6" x 5"	<b>76082</b>	\$1,522.50
8" x 6"	<b>3998060S</b>	\$2,899.50

Nipple is segmentally welded.

Orders for items in shaded areas **cannot** be cancelled or returned.

#### Technical Data Sheet: G180

Introduction
Couplings & Fittings
Mechanical Tees
Valves
Circuit Balancing Valves
Accessories
Copper Systems
Stainless Steel Systems
Plain End Systems
Stainless Steel G-PRESS
HDPE Systems
Gaskets & Spare Parts
Preparation Equipment
Miscellaneous
Indices

**#730 Mechanical Tee – Threaded  
 with Grade “E” or Grade “T” Nitrile Gasket**

Nominal Size	Painted			Galvanized		
	Grade “E” EPDM	Grade “T” Nitrile	List Price	Grade “E” EPDM	Grade “T” Nitrile	List Price
2" x 1/2"	7302005ES	7302005TS	\$79.50	7302005EGS	7302005TGS	\$100.50
2" x 3/4"	73020075ES	73020075TS	\$79.50	73020075EGS	73020075TGS	\$100.50
2" x 1"	7302010ES	7302010TS	\$79.50	7302010EGS	7302010TGS	\$100.50
2" x 1 1/4"	7302013ES	7302013TS	\$92.00	7302013EGS	7302013TGS	\$114.50
2" x 1 1/2"	7302015ES	7302015TS	\$92.00	7302015EGS	7302015TGS	\$114.50
2 1/2" x 1/2"	7302505ES	7302505TS	\$79.50	7302505EGS	7302505TGS	\$100.50
2 1/2" x 3/4"	73025075ES	73025075TS	\$79.50	73025075EGS	73025075TGS	\$100.50
2 1/2" x 1"	7302510ES	7302510TS	\$79.50	7302510EGS	7302510TGS	\$100.50
2 1/2" x 1 1/4"	7302513ES	7302513TS	\$112.00	7302513EGS	7302513TGS	\$136.50
2 1/2" x 1 1/2"	7302515ES	7302515TS	\$112.00	7302515EGS	7302515TGS	\$136.50
2 1/2" x 2"	7302520EP	7302520TP	\$112.00	7302520EGP	7302520TGP	\$136.50
3" x 1/2"	7303005ES	7303005TS	\$92.00	7303005EGS	7303005TGS	\$112.00
3" x 3/4"	73030075ES	73030075TS	\$92.00	73030075EGS	73030075TGS	\$112.00
3" x 1"	7303010ES	7303010TS	\$92.00	7303010EGS	7303010TGS	\$112.00
3" x 1 1/4"	7303013ES	7303013TS	\$116.50	7303013EGS	7303013TGS	\$145.50
3" x 1 1/2"	7303015ES	7303015TS	\$116.50	7303015EGS	7303015TGS	\$145.50
3" x 2"	7303020ES	7303020TS	\$134.00	7303020EGS	7303020TGS	\$166.50
4" x 1/2"	7304005ES	7304005TS	\$116.00	7304005EGS	7304005TGS	\$138.00
4" x 3/4"	73040075ES	73040075TS	\$116.00	73040075EGS	73040075TGS	\$138.00
4" x 1"	7304010ES	7304010TS	\$116.00	7304010EGS	7304010TGS	\$138.00
4" x 1 1/4"	7304013ES	7304013TS	\$135.50	7304013EGS	7304013TGS	\$160.00
4" x 1 1/2"	7304015ES	7304015TS	\$141.00	7304015EGS	7304015TGS	\$177.50
4" x 2"	7304020ES	7304020TS	\$141.00	7304020EGS	7304020TGS	\$179.00
4" x 2 1/2"	7304025ES	7304025TS	\$147.00	7304025EGS	7304025TGS	\$190.50
4" x 3"	7304030ES	7304030TS	\$156.50	7304030EGS	7304030TGS	\$201.00
5" x 1 1/2"	7305015EP	7305015TP	\$172.00	7305015EGP	7305015TGP	\$218.00
5" x 2"	7305020ES	7305020TS	\$172.00	7305020EGS	7305020TGS	\$218.00
5" x 2 1/2"	7305025ES	7305025TS	\$181.50	7305025EGS	7305025TGS	\$231.50
5" x 3"	7305030EP	7305030TP	\$193.00	7305030EGP	7305030TGP	\$248.50
6" x 1 1/4"	7306013EP	7306013TP	\$176.50	7306013EGP	7306013TGP	\$225.50
6" x 1 1/2"	7306015ES	7306015TS	\$176.50	7306015EGS	7306015TGS	\$225.50
6" x 2"	7306020ES	7306020TS	\$176.50	7306020EGS	7306020TGS	\$225.50
6" x 2 1/2"	7306025ES	7306025TS	\$190.00	7306025EGS	7306025TGS	\$245.50
6" x 3"	7306030ES	7306030TS	\$201.50	7306030EGS	7306030TGS	\$259.50
6" x 4"	7306040ES	7306040TS	\$223.50	7306040EGS	7306040TGS	\$291.00
8" x 2 1/2"	7308025ES	7308025TS	\$308.00	7308025EGS	7308025TGS	\$388.50
8" x 3"	7308030ES	7308030TS	\$325.00	7308030EGS	7308030TGS	\$412.00
8" x 4"	7308040ES	7308040TS	\$334.50	7308040EGS	7308040TGS	\$432.00

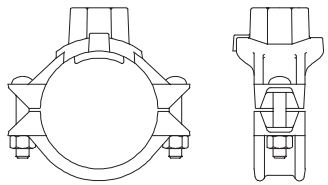
 Orders for items in shaded areas *cannot* be cancelled or returned.

**Technical Data Sheet: G210**

# Tyco Mechanical Products

## Section 3 – Mechanical Tees



### #730 Mechanical Tee – Grooved with Grade “E” or Grade “T” Nitrile Gasket

Nominal Size	Painted			Galvanized		
	Grade “E” EPDM	Grade “T” Nitrile	List Price	Grade “E” EPDM	Grade “T” Nitrile	List Price
2" x 1 1/4"	7302013ERS	7302013TRS	\$92.00	7302013EGRS	7302013TGRS	\$114.50
2" x 1 1/2"	7302015ERS	7302015TRS	\$92.00	7302015EGRS	7302015TGRS	\$114.50
2 1/2" x 1 1/4"	7302513ERS	7302513TRS	\$112.00	7302513EGRS	7302513TGRS	\$136.50
2 1/2" x 1 1/2"	7302515ERS	7302515TRS	\$112.00	7302515EGRS	7302515TGRS	\$136.50
2 1/2" x 2"	7302520ERP	7302520TRP	POA	7302520EGRP	7302520TGRP	POA
3" x 1 1/4"	7303013ERS	7303013TRS	\$116.50	7303013EGRS	7303013TGRS	\$145.50
3" x 1 1/2"	7303015ERS	7303015TRS	\$116.50	7303015EGRS	7303015TGRS	\$145.50
3" x 2"	7303020ERS	7303020TRS	\$134.00	7303020EGRS	7303020TGRS	\$166.50
4" x 1 1/4"	7304013ERS	7304013TRS	\$135.50	7304013EGRS	7304013TGRS	\$160.00
4" x 1 1/2"	7304015ERS	7304015TRS	\$141.00	7304015EGRS	7304015TGRS	\$177.50
4" x 2"	7304020ERS	7304020TRS	\$141.00	7304020EGRS	7304020TGRS	\$179.00
4" x 2 1/2"	7304025ERS	7304025TRS	\$147.00	7304025EGRS	7304025TGRS	\$190.50
4" x 3"	7304030ERS	7304030TRS	\$156.50	7304030EGRS	7304030TGRS	\$201.00
5" x 1 1/2"	7305015ERP	7305015TRP	\$172.00	7305015EGRP	7305015TGRP	\$218.00
5" x 2"	7305020ERS	7305020TRS	\$172.00	7305020EGRS	7305020TGRS	\$218.00
5" x 2 1/2"	7305025ERS	7305025TRS	\$181.50	7305025EGRS	7305025TGRS	\$231.50
5" x 3"	7305030ERP	7305030TRP	\$193.00	7305030EGRP	7305030TGRP	\$248.50
6" x 1 1/4"	7306013ERP	7306013TRP	\$176.50	7306013EGRP	7306013TGRP	\$225.50
6" x 1 1/2"	7306015ERS	7306015TRS	\$176.50	7306015EGRS	7306015TGRS	\$225.50
6" x 2"	7306020ERS	7306020TRS	\$176.50	7306020EGRS	7306020TGRS	\$225.50
6" x 2 1/2"	7306025ERS	7306025TRS	\$193.00	7306025EGRS	7306025TGRS	\$245.50
6" x 3"	7306030ERS	7306030TRS	\$201.50	7306030EGRS	7306030TGRS	\$259.50
6" x 4"	7306040ERS	7306040TRS	\$223.50	7306040EGRS	7306040TGRS	\$291.00
8" x 2 1/2"	7308025ERS	7308025TRS	\$308.00	7308025EGRS	7308025TGRS	\$388.50
8" x 3"	7308030ERS	7308030TRS	\$325.00	7308030EGRS	7308030TGRS	\$412.00
8" x 4"	7308040ERS	7308040TRS	\$334.50	7308040EGRS	7308040TGRS	\$432.00

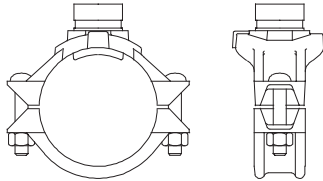

Orders for items in shaded areas *cannot* be cancelled or returned.

Technical Data Sheet: G210

Introduction  
Couplings & Fittings  
Mechanical Tees  
Valves  
Circuit Balancing Valves  
Accessories  
Copper Systems  
Stainless Steel Systems  
Plain End Systems  
Stainless Steel G-PRESS  
HDPE Systems  
Gaskets & Spare Parts  
Preparation Equipment  
Miscellaneous  
Indices

**#730 Mechanical Cross – Threaded  
 with Grade “E” or Grade “T” Nitrile Gasket**

Nominal Size	Painted			Galvanized		
	Grade “E” EPDM	Grade “T” Nitrile	List Price	Grade “E” EPDM	Grade “T” Nitrile	List Price
2" x 1"	7302010ECS	7302010TCS	\$126.00	7302010EGCS	7302010TGCS	\$161.00
2" x 1 1/4"	7302013ECS	7302013TCS	\$144.00	7302013EGCS	7302013TGCS	\$184.50
2" x 1 1/2"	7302015ECS	7302015TCS	\$144.00	7302015EGCS	7302015TGCS	\$184.50
2 1/2" x 1"	7302510ECS	7302510TCS	\$126.00	7302510EGCS	7302510TGCS	\$161.00
2 1/2" x 1 1/4"	7302513ECS	7302513TCS	\$172.50	7302513EGCS	7302513TGCS	\$223.00
2 1/2" x 1 1/2"	7302515ECS	7302515TCS	\$172.50	7302515EGCS	7302515TGCS	\$184.50
3" x 1"	7303010ECS	7303010TCS	\$141.00	7303010EGCS	7303010TGCS	\$181.50
3" x 1 1/4"	7303013ECS	7303013TCS	\$172.50	7303013EGCS	7303013TGCS	\$215.50
3" x 1 1/2"	7303015ECS	7303015TCS	\$172.50	7303015EGCS	7303015TGCS	\$215.50
3" x 2"	7303020ECS	7303020TCS	\$199.50	7303020EGCS	7303020TGCS	\$247.00
4" x 3/4"	7304075ECS	7304075TCS	\$172.50	7304075EGCS	7304075TGCS	\$224.00
4" x 1"	7304010ECS	7304010TCS	\$172.50	7304010EGCS	7304010TGCS	\$224.00
4" x 1 1/4"	7304013ECS	7304013TCS	\$209.50	7304013EGCS	7304013TGCS	\$263.00
4" x 1 1/2"	7304015ECS	7304015TCS	\$209.50	7304015EGCS	7304015TGCS	\$263.00
4" x 2"	7304020ECS	7304020TCS	\$224.00	7304020EGCS	7304020TGCS	\$264.50
4" x 2 1/2"	7304025ECS	7304025TCS	\$224.00	7304025EGCS	7304025TGCS	\$285.00
4" x 3"	7304030ECS	7304030TCS	\$233.50	7304030EGCS	7304030TGCS	\$302.00
5" x 2"	7305020ECS	7305020TCS	\$256.00	7305020EGCS	7305020TGCS	\$325.00
5" x 2 1/2"	7305025ECS	7305025TCS	\$269.50	7305025EGCS	7305025TGCS	\$344.00
5" x 3"	7305030ECP	7305030TCP	\$289.00	7305030EGCP	7305030TGCP	\$370.50
6" x 1 1/2"	7306015ECS	7306015TCS	\$262.50	7306015EGCS	7306015TGCS	\$337.50
6" x 2"	7306020ECS	7306020TCS	\$273.50	7306020EGCS	7306020TGCS	\$364.50
6" x 2 1/2"	7306025ECS	7306025TCS	\$281.50	7306025EGCS	7306025TGCS	\$364.50
6" x 3"	7306030ECS	7306030TCS	\$301.00	7306030EGCS	7306030TGCS	\$386.00
6" x 4"	7306040ECS	7306040TCS	\$333.00	7306040EGCS	7306040TGCS	\$432.00
8" x 2 1/2"	7308025ECS	7308025TCS	\$460.50	7308025EGCS	7308025TGCS	\$581.00
8" x 3"	7308030ECS	7308030TCS	\$484.50	7308030EGCS	7308030TGCS	\$616.00
8" x 4"	7308040ECS	7308040TCS	\$501.00	7308040EGCS	7308040TGCS	\$647.50

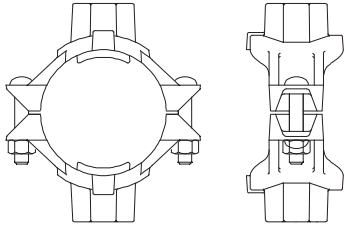
 Orders for items in shaded areas *cannot* be cancelled or returned.

**Technical Data Sheet: G210**

# Tyco Mechanical Products

## Section 3 – Mechanical Tees



### #730 Mechanical Cross – Grooved with Grade “E” or Grade “T” Nitrile Gasket

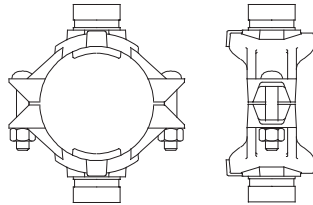

Nominal Size	Painted			Galvanized		
	Grade “E” EPDM	Grade “T” Nitrile	List Price	Grade “E” EPDM	Grade “T” Nitrile	List Price
2" x 1 1/4"	7302013ERCS	7302013TRCS	\$144.00	7302013EGRCS	7302013TGRCS	\$184.50
2" x 1 1/2"	7302015ERCS	7302015TRCS	\$144.00	7302015EGRCS	7302015TGRCS	\$184.50
2 1/2" x 1 1/4"	7302513ERCS	7302513TRCS	\$172.50	7302513EGRCS	7302513TGRCS	\$223.00
2 1/2" x 1 1/2"	7302515ERCS	7302515TRCS	\$172.50	7302515EGRCS	7302515TGRCS	\$184.50
3" x 1 1/4"	7303013ERCS	7303013TRCS	\$172.50	7303013EGRCS	7303013TGRCS	\$215.50
3" x 1 1/2"	7303015ERCS	7303015TRCS	\$172.50	7303015EGRCS	7303015TGRCS	\$215.50
3" x 2"	7303020ERCS	7303020TRCS	\$199.50	7303020EGRCS	7303020TGRCS	\$247.00
4" x 1 1/4"	7304013ERCS	7304013TRCS	\$209.50	7304013EGRCS	7304013TGRCS	\$263.00
4" x 1 1/2"	7304015ERCS	7304015TRCS	\$209.50	7304015EGRCS	7304015TGRCS	\$263.00
4" x 2"	7304020ERCS	7304020TRCS	\$224.00	7304020EGRCS	7304020TGRCS	\$264.50
4" x 2 1/2"	7304025ERCS	7304025TRCS	\$224.00	7304025EGRCS	7304025TGRCS	\$285.00
4" x 3"	7304030ERCS	7304030TRCS	\$233.50	7304030EGRCS	7304030TGRCS	\$302.00
5" x 2"	7305020ERCS	7305020TRCS	\$256.00	7305020EGRCS	7305020TGRCS	\$325.00
5" x 2 1/2"	7305025ERCS	7305025TRCS	\$269.50	7305025EGRCS	7305025TGRCS	\$344.00
5" x 3"	7305030ERCS	7305030TRCS	\$289.00	7305030EGRCS	7305030TGRCS	\$370.50
6" x 1 1/2"	7306015ERCS	7306015TRCS	\$262.50	7306015EGRCS	7306015TGRCS	\$337.50
6" x 2"	7306020ERCS	7306020TRCS	\$273.50	7306020EGRCS	7306020TGRCS	\$364.50
6" x 2 1/2"	7306025ERCS	7306025TRCS	\$281.50	7306025EGRCS	7306025TGRCS	\$364.50
6" x 3"	7306030ERCS	7306030TRCS	\$301.00	7306030EGRCS	7306030TGRCS	\$386.00
6" x 4"	7306040ERCS	7306040TRCS	\$333.00	7306040EGRCS	7306040TGRCS	\$432.00
8" x 2 1/2"	7308025ERCS	7308025TRCS	\$460.50	7308025EGRCS	7308025TGRCS	\$581.00
8" x 3"	7308030ERCS	7308030TRCS	\$484.50	7308030EGRCS	7308030TGRCS	\$616.00
8" x 4"	7308040ERCS	7308040TRCS	\$501.00	7308040EGRCS	7308040TGRCS	\$647.50

Orders for items in shaded areas **cannot** be cancelled or returned.

**Technical Data Sheet: G210**

Introduction  
Couplings & Fittings  
Mechanical Tees  
Valves  
Circuit Balancing Valves  
Accessories  
Copper Systems  
Stainless Steel Systems  
Plain End Systems  
Stainless Steel G-PRESS  
HDPE Systems  
Gaskets & Spare Parts  
Preparation Equipment  
Miscellaneous  
Indices

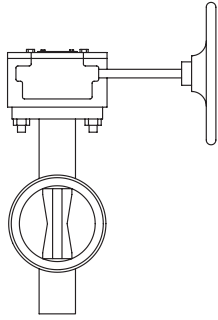
**#B302 Grooved Butterfly Valve – EPDM or Nitrile**

Available with Gear Operator and Handwheel (as pictured) or Lever Lock Handle. Specify choice when ordering.

Size	Lever Lock Part #		List Price	Gear Op. Part #		List Price
	EPDM, w Lever	Nitrile, with Lever		EPDM, with Gear Op.	Nitrile, with Gear Op.	
2"	B30220EL	B30220TL	\$692.00	B30220EG	B30220TG	\$1,264.50
2½"	B30225EL	B30225TL	\$852.50	B30225EG	B30225TG	\$1,423.50
3"	B30230EL	B30230TL	\$889.50	B30230EG	B30230TG	\$1,460.50
4"	B30240EL	B30240TL	\$1,062.00	B30240EG	B30240TG	\$1,634.00
5"	B30250EL	B30250TL	\$1,892.00	B30250EG	B30250TG	\$2,463.50
6"	B30260EL	B30260TL	\$1,998.50	B30260EG	B30260TG	\$2,545.50
8"	B30280EL	B30280TL	\$2,598.50	B30280EG	B30280TG	\$3,146.00
10"	–	–	–	B30210EG	B30210TG	\$4,171.50
12"	–	–	–	B30212EG	B30212TG	\$4,625.00

Technical Data Sheet: G310

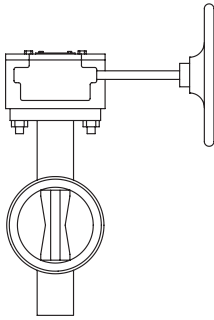
**#B302 Grooved Butterfly Valve – Fluoroelastomer**

Available with Gear Operator and Handwheel (as pictured) or Lever Lock Handle. Specify choice when ordering.

Size	Lever Handle		Gear Operator	
	Part #	List Price	Part #	List Price
2"	B30220LO	\$988.50	B30220GO	\$1,337.00
2½"	B30225LO	\$1,145.50	B30225GO	\$1,491.00
3"	B30230LO	\$1,271.00	B30230GO	\$1,558.00
4"	B30240LO	\$1,418.00	B30240GO	\$1,764.00
5"	B30250LO	\$2,719.50	B30250GO	\$2,630.50
6"	B30260LO	\$2,786.00	B30260GO	\$3,226.50
8"	B30280LO	\$3,580.00	B30280GO	\$4,272.50
10"	–	–	B30210GO	\$5,559.00
12"	–	–	B30212GO	\$6,204.50

Orders for items in shaded areas **cannot** be cancelled or returned.

Technical Data Sheet: G310

# Tyco Mechanical Products

## Section 4 – Valves



### #BN302 Grooved Butterfly Valve – EPDM NSF Approved

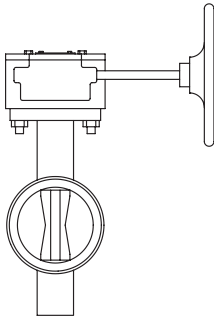

Available with Gear Operator and Handwheel  
(as pictured) or Lever Lock Handle.  
Specify choice when ordering.

Size	Lever Handle		Gear Operator	
	Part #	List Price	Part #	List Price
2"	BN30220EL	\$692.00	BN30220EG	\$1,264.50
2½"	BN30225EL	\$852.50	BN30225EG	\$1,423.50
3"	BN30230EL	\$889.50	BN30230EG	\$1,460.50
4"	BN30240EL	\$1,062.00	BN30240EG	\$1,634.00
5"	BN30250EL	\$1,892.00	BN30250EG	\$2,463.50
6"	BN30260EL	\$1,998.50	BN30260EG	\$2,545.50
8"	BN30280EL	\$2,598.50	BN30280EG	\$3,146.00
10"	-	-	BN30210EG	\$4,171.50
12"	-	-	BN30212EG	\$4,625.00

Orders for items in shaded areas **cannot** be cancelled or returned.

**Technical Data Sheet: G310**

### #B302 and #BN302 Grooved Butterfly Valve – Accessories

Size	Description	Part Number	List Price
2"	Mechanical BFV Gear Operator 2" & Bushing	GOH30220	\$996.00
2½"	Mechanical BFV Gear Operator 2½" & Bushing	GOH30225	\$996.00
3"	Mechanical BFV Gear Operator 3" & Bushing	GOH30230	\$996.00
4"	Mechanical BFV Gear Operator 4" & Bushing	GOH30240	\$996.00
5"	Mechanical BFV Gear Operator 5" & Bushing	GOH30250	\$996.00
6"	Mechanical BFV Gear Operator 6" & Bushing	GOH30260	\$996.00
8"	Mechanical BFV Gear Operator 8" & Bushing	GOH30280	\$996.00
10"	Mechanical BFV Gear Operator 10"	GOH30210	\$1,021.00
12"	Mechanical BFV Gear Operator 12"	GOH30212	\$1,021.00
2"	Mechanical BFV Lever Handle 2" & PLT	LH30220	\$230.50
2½"	Mechanical BFV Lever Handle 2½" & PLT	LH30225	\$230.50
3"	Mechanical BFV Lever Handle 3" & PLT	LH30230	\$230.50
4"	Mechanical BFV Lever Handle 4" & PLT	LH30240	\$261.50
5"	Mechanical BFV Lever Handle 5" & PLT	LH30250	\$261.50
6"	Mechanical BFV Lever Handle 6" & PLT	LH30260	\$261.50
8"	Mechanical BFV Lever Handle 8" & PLT	LH30280	\$261.50

Orders for items in shaded areas **cannot** be cancelled or returned.

**Technical Data Sheet: G310**

Introduction  
Couplings & Fittings  
Mechanical Tees  
Valves  
Circuit Balancing Valves  
Accessories  
Copper Systems  
Stainless Steel Systems  
Plain End Systems  
Stainless Steel G-PRESS  
HDPE Systems  
Gaskets & Spare Parts  
Preparation Equipment  
Miscellaneous  
Indices

**Model B333 Grooved Butterfly Valve,  
 EPDM or Nitrile, Gear Operator**

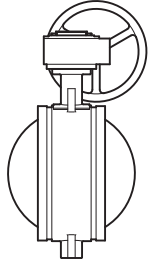
	Size	Part Number		List Price
		EPDM	Nitrile	
	14"	B33314EG	B33314TG	\$6,191.00
	16"	B33316EG	B33316TG	\$8,469.00
	18"	B33318EG	B33318TG	\$10,423.50
	20"	B33320EG	B33320TG	\$14,104.50
24"	B33324EG	B33324TG	\$17,961.00	
Contact Tyco representative for availability				
Orders for items in shaded areas <i>cannot</i> be cancelled or returned.				
<b>Technical Data Sheet: G325</b>				

**#B308 Grooved Butterfly Valve,  
 EPDM or Nitrile – D.I. Nickle Plated, Gear Operator**

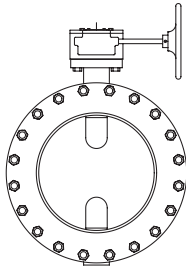
	Size	Part Number		List Price
		EPDM	Nitrile	
	14"	B30814ENG	B30814TNG	\$6,191.00
	16"	B30816ENG	B30816TNG	\$8,469.00
	18"	B30818ENG	B30818TNG	\$10,423.50
	20"	B30820ENG	B30820TNG	\$14,104.50
24"	B30824ENG	B30824TNG	\$17,961.00	
Contact Tyco representative for other component material options.				
Orders for items in shaded areas <i>cannot</i> be cancelled or returned.				
<b>Technical Data Sheet: G320</b>				



**Babbitt Valve Chainwheels**

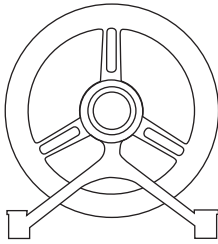

**Cast Iron Standard Chainwheel**

<i>Item No.</i>	<i>Hand Wheel Size</i>	<i>Part Number</i>	<i>List Price</i>
0	2" to 4"	5036	\$229.00
1	4 <sup>1</sup> / <sub>4</sub> " to 5 <sup>3</sup> / <sub>4</sub> "	5037	\$332.50
1.5	6" to 7 <sup>1</sup> / <sub>2</sub> "	5031	\$403.00
2	7 <sup>3</sup> / <sub>4</sub> " to 9"	5038	\$532.00
2.5	9 <sup>1</sup> / <sub>4</sub> " to 12 <sup>1</sup> / <sub>2</sub> "	5039	\$763.50
3	12 <sup>3</sup> / <sub>4</sub> " to 15 <sup>1</sup> / <sub>2</sub> "	5040	\$887.00
3.5	15 <sup>3</sup> / <sub>4</sub> " to 19"	5041A	\$1,343.00

**Epoxy Coated Corrosion Resistant Chainwheel**

0	2" to 4"	5025	\$496.50
1	4 <sup>1</sup> / <sub>4</sub> " to 5 <sup>3</sup> / <sub>4</sub> "	5026	\$797.50
1.5	6" to 7 <sup>1</sup> / <sub>2</sub> "	5027	\$1,019.00
2	7 <sup>3</sup> / <sub>4</sub> " to 9"	5028	\$1,251.00
2.5	9 <sup>1</sup> / <sub>4</sub> " to 12 <sup>1</sup> / <sub>2</sub> "	5033	\$1,619.00
3	12 <sup>3</sup> / <sub>4</sub> " to 15 <sup>1</sup> / <sub>2</sub> "	5034	\$1,996.00
3.5	15 <sup>3</sup> / <sub>4</sub> " to 19"	5035	\$2,463.00

**Hot Dipped Galvanized Standard Chain**

<i>Item No.</i>	<i>Part Number</i>	<i>List Price Per Foot</i>
0	5029	\$7.50
1 to 2	5030	\$10.00
2.5 to 3.5	5032	\$13.50

Orders for items in shaded areas **cannot** be cancelled or returned.

Introduction  
 Couplings & Fittings  
 Mechanical Tees  
 Valves  
 Circuit Balancing Valves  
 Accessories  
 Copper Systems  
 Stainless Steel Systems  
 Plain End Systems  
 Stainless Steel G-PRESS  
 HDPE Systems  
 Gaskets & Spare Parts  
 Preparation Equipment  
 Miscellaneous  
 Indices

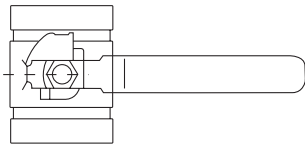
**#B8101 Low Profile Butterfly Valve  
 with Lever Handle**

<i>Size</i>	<i>Part Number</i>	<i>List Price</i>
2"	B810120E	\$606.50
2½"	B810125E	\$771.00
3"	B810130E	\$871.00
4"	B810140E	\$957.50
5"	B810150E	\$1,824.00
6"	B810160E	\$1,930.50

 Orders for items in shaded areas *cannot* be cancelled or returned.

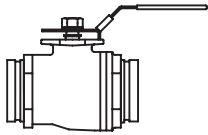
**Technical Data Sheet: G330**
**BV835 Grooved Ball Valve**

<i>Size</i>	<i>Lever Handle</i>		<i>Gear Operator</i>	
	<i>Part Number</i>	<i>List Price</i>	<i>Part Number</i>	<i>List Price</i>
1½"	BV83515	\$338.50	BV83515G	\$899.00
2"	BV83520	\$375.50	BV83520G	\$1,259.50
2½"	BV83525	\$818.00	BV83525G	\$1,654.00
3"	BV83530	\$1,321.50	BV83530G	\$2,342.50
4"	BV83540M	\$2,044.00	BV83540G	\$2,984.00
6"	BV83560	\$6,271.00	BV83560G	\$7,039.00

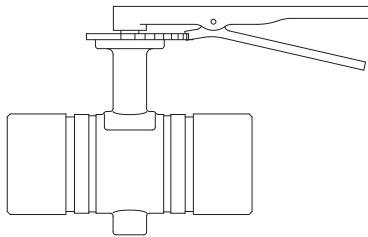
**Technical Data Sheet: G380**
**#B8200L Grooved Butterfly Valve – EPDM  
 (For Use In PVC Piping Systems)**

<i>Nominal Size</i>	<i>Part Number</i>	<i>List Price</i>
2"	B820020	\$375.00
3"	B820030	\$490.50
4"	B820040	\$631.00
6"	B820060	\$1,052.50
8"	B820080	\$1,258.00

 Orders for items in shaded areas *cannot* be cancelled or returned.

**Technical Data Sheet: G592**

**#590 Grooved Check Valve, EPDM or Nitrile**

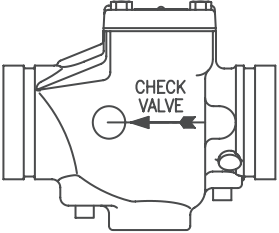
	Size	EPDM Part Number		Nitrile Part Number		List Price
		Domestic	Import	Domestic	Import	
		2"	59030020	59030020P	59030020T	
2½"	59030025	59030025P	–	59030025TP	\$645.50	
3"	59030030	59030030P	–	59030030TP	\$762.00	
4"	59030040	59030040P	59030040T	59030040TP	\$805.00	
5"	59030050	59030050P	–	59030050TP	\$1,337.50	
6"	59030060	59030060P	59030060T	59030060TP	\$1,585.50	
8"	59030080	59030080P	59030080T	59030080TP	\$2,166.00	
10"	590300100	590300100P	–	590300100TP	\$5,796.00	
12"	–	590300120P	–	590300120TP	\$6,867.50	

Orders for items in shaded areas *cannot* be cancelled or returned.

**Technical Data Sheet: G350**

**#CV890 Grooved Dual Disk Check Valve, EPDM or Nitrile**

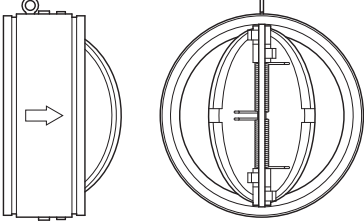
	Size	Part Number		List Price
		EPDM	Nitrile	
		14"	CV89014E	
16"	CV89016E	CV89016T	\$8,436.00	
18"	CV89018E	CV89018T	\$11,136.00	
20"	CV89020E	CV89020T	\$14,638.50	
24"	CV89024E	CV89024T	\$18,456.50	

Orders for items in shaded areas *cannot* be cancelled or returned.

**Technical Data Sheet: G354**

**#TD830, Triple Duty Valve, Flow Control Type**

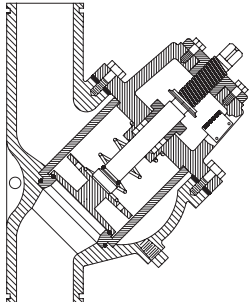
	Size	Part Number	List Price
	2"	TD83020	\$3,526.00
	2½"	TD83025	\$3,572.00
3"	TD83030	\$3,886.00	
4"	TD83040	\$5,328.00	
5"	TD83050	\$5,830.00	
6"	TD83060	\$8,725.00	
8"	TD83080	\$12,954.00	
10"	TD83010	\$21,632.00	
12"	TD83012	\$30,606.00	
14"	TD83014	\$47,236.00	

Orders for items in shaded areas *cannot* be cancelled or returned.

**Technical Data Sheet: G390**

Introduction  
Couplings & Fittings  
Mechanical Tees  
Valves  
Circuit Balancing Valves  
Accessories  
Copper Systems  
Stainless Steel Systems  
Plain End Systems  
Stainless Steel G-PRESS  
HDPE Systems  
Gaskets & Spare Parts  
Preparation Equipment  
Miscellaneous  
Indices

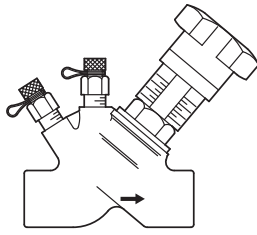
**#CB800 Solder x Solder – Circuit Balancing Valve**

<i>Size</i>	<i>Part #</i>	<i>List Price</i>
1/2"	CB8000501	\$90.00
3/4"	CB8000751	\$95.00
1"	CB8001001	\$127.00
1 1/4"	CB8001251	\$195.00
1 1/2"	CB8001501	\$225.00
2"	CB8002001	\$338.00

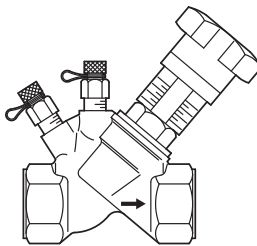
**Technical Data Sheet: G450**
**#CB800 Thread x Thread – Circuit Balancing Valve**

<i>Size</i>	<i>Part #</i>	<i>List Price</i>
1/2"	CB8005002	\$88.00
3/4"	CB8000752	\$96.00
1"	CB8001002	\$129.00
1 1/4"	CB8001252	\$198.00
1 1/2"	CB8001502	\$228.00
2"	CB8002002	\$341.00

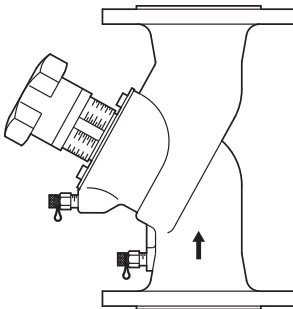
**Technical Data Sheet: G450**
**#CB800 Flange x Flange – Circuit Balancing Valve**

<i>Size</i>	<i>Part Number</i>	<i>List Price</i>
2 1/2"	CB8002503	\$846.50
3"	CB8003003	\$1,293.00
4"	CB8004003	\$1,782.00
5"	CB8005003	\$3,188.50
6"	CB8006003	\$4,075.50
8"	CB8008003	\$8,807.50
10"	CB8001103	\$11,439.50
12"	CB8001203	\$23,950.50

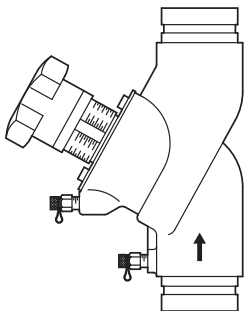
**Technical Data Sheet: G450**
**#CB800 Groove x Groove – Circuit Balancing Valve**

<i>Size</i>	<i>Part Number</i>	<i>List Price</i>
2 1/2"	CB8002504	\$732.00
3"	CB8003004	\$1,138.00
4"	CB8004004	\$1,573.00
5"	CB8005004	\$2,846.50
6"	CB8006004	\$3,813.00
8"	CB8008004	\$8,123.00
10"	CB8001104	\$10,658.00
12"	CB8001204	\$23,159.50

**Technical Data Sheet: G450**

# Tyco Mechanical Products

## Section 5 – Circuit Balancing Valves



### #CB800 Circuit Balancing Valves – Accessories

	Description	Part Number	List Price
	Fill & Drain Ball Valve 1/4"	<b>CBBV025</b>	\$64.75
	Set of Two Pressure Test Points	<b>CBTP02</b>	\$107.00
	Set of One Pressure Test Point & One Fill & Drain Ball Valve	<b>CBTK02</b>	\$118.00
	Stem Extension 3/8" – 6", 1.38"	<b>CBSE7560</b>	\$58.50
	Hose BIB Kit	<b>1659300</b>	\$41.00
	CBV Needles	<b>CBSR100</b>	\$320.00
	Test Point Ext 80mm	<b>CBTPX80</b>	\$61.50
	Measuring Adapter	<b>CBMA01</b>	\$31.50

Orders for items in shaded areas **cannot** be cancelled or returned.

**Technical Data Sheet: G450**

### Insulation Kits for #CB800 Circuit Balancing Valves

	Size	Part Number	List Price
	1/2"	<b>CBIS050</b>	\$26.00
	3/4"	<b>CBIS075</b>	\$26.00
	1"	<b>CBIS010</b>	\$28.50
	1 1/4"	<b>CBIS125</b>	\$32.00
	1 1/2"	<b>CBIS150</b>	\$35.00
	2"	<b>CBIS200</b>	\$42.50
	2 1/2"	<b>CBIS250</b>	\$476.50
	3"	<b>CBIS300</b>	\$530.00
	4"	<b>CBIS400</b>	\$589.00
	5"	<b>CBIS500</b>	\$658.00
6"	<b>CBIS600</b>	\$812.00	
8"	<b>CBIS800</b>	POA	

Orders for items in shaded areas **cannot** be cancelled or returned.

**Technical Data Sheet: G450**

### Differential Measuring Computer

	Description	Part #	List Price
	Differential Measuring Computer	<b>CBMDMC2</b>	\$7,643.50

Orders for items in shaded areas **cannot** be cancelled or returned.

**Technical Data Sheet: G450**

Introduction  
Couplings & Fittings  
Mechanical Tees  
Valves  
Circuit Balancing Valves  
Accessories  
Copper Systems  
Stainless Steel Systems  
Plain End Systems  
Stainless Steel G-PRESS  
HDPE Systems  
Gaskets & Spare Parts  
Preparation Equipment  
Miscellaneous  
Indices

**#S853 Grooved Wye Strainer**

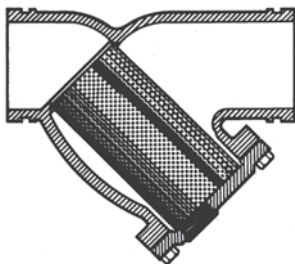
	Size	Painted		Galvanized	
		Part Number	List Price	Part Number	List Price
	2"	<b>S85320</b>	\$1,536.50	<b>S85320G</b>	\$1,718.00
2½"	<b>S85325</b>	\$1,614.50	<b>S85325G</b>	\$1,828.00	
3"	<b>S85330</b>	\$1,813.50	<b>S85330G</b>	\$2,084.00	
4"	<b>S85340</b>	\$2,052.00	<b>S85340G</b>	\$2,425.50	
5"	<b>S85350</b>	\$2,969.50	<b>S85350G</b>	\$3,537.50	
6"	<b>S85360</b>	\$3,223.00	<b>S85360G</b>	\$3,967.00	
8"	<b>S85380</b>	\$4,940.00	<b>S85380G</b>	\$6,182.00	
10"	<b>S85310</b>	\$7,939.00	<b>S85310G</b>	\$9,965.00	
12"	<b>S85312</b>	\$13,864.50	<b>S85312G</b>	\$16,849.50	

 Orders for items in shaded areas **cannot** be cancelled or returned.

Galvanized items have minimum order quantities of 10 pcs (2" thru 4") and 5 pcs (5" &amp; larger) per line item or a small order charge of \$650.00 per line item will be assessed.

**Technical Data Sheet: G420**
**#S855 Grooved Tee – Type Strainer**

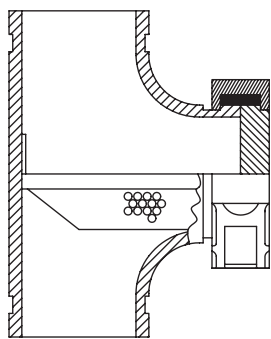
	Size	Painted		Galvanized	
		Part Number	List Price	Part Number	List Price
	2"	<b>S85520</b>	\$1,517.50	<b>S85520G</b>	\$1,779.50
2½"	<b>S85525</b>	\$1,595.00	<b>S85525G</b>	\$1,879.50	
3"	<b>S85530</b>	\$1,790.00	<b>S85530G</b>	\$2,142.50	
4"	<b>S85540</b>	\$2,025.50	<b>S85540G</b>	\$2,482.00	
5"	<b>S85550</b>	\$2,933.50	<b>S85550G</b>	\$3,512.50	
6"	<b>S85560</b>	\$3,183.00	<b>S85560G</b>	\$3,881.00	
8"	<b>S85580</b>	\$4,878.50	<b>S85580G</b>	\$5,990.00	
10"	<b>S85510</b>	\$7,162.00	<b>S85510G</b>	\$8,841.50	
12"	<b>S85512</b>	\$9,220.00	<b>S85512G</b>	\$11,353.50	

 Orders for items in shaded areas **cannot** be cancelled or returned.

Galvanized items have minimum order quantities of 10 pcs (2" thru 4") and 5 pcs (5" &amp; larger) per line item or a small order charge of \$650.00 per line item will be assessed.

**Technical Data Sheet: G430**

**#S810 Groove x Flange ANSI – Suction Diffuser**

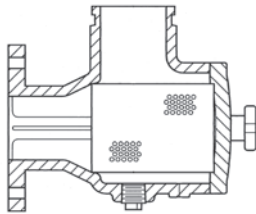

<i>Size</i>	<i>Part #</i>	<i>List Price</i>
3" x 2"	<b>S8103020</b>	\$3,122.00
3" x 2 1/2"	<b>S8103025</b>	\$2,245.00
3" x 3"	<b>S8103030</b>	\$2,275.00
4" x 2"	<b>S8104020</b>	POA
4" x 2 1/2"	<b>S8104025</b>	\$2,466.00
4" x 3"	<b>S8104030</b>	\$2,660.00
4" x 4"	<b>S8104040</b>	\$3,081.00
5" x 3"	<b>S8105030</b>	\$4,313.00
5" x 4"	<b>S8105040</b>	\$3,434.50
5" x 5"	<b>S8105050</b>	\$3,607.50
6" x 3"	<b>S8106030</b>	POA
6" x 4"	<b>S8106040</b>	\$3,661.50
6" x 5"	<b>S8106050</b>	\$4,378.50
6" x 6"	<b>S8106060</b>	\$4,546.50
8" x 5"	<b>S8108050</b>	\$4,663.00
8" x 6"	<b>S8108060</b>	\$4,917.00
8" x 8"	<b>S8108080</b>	\$8,460.50
10" x 6"	<b>S8101060</b>	\$8,783.50
10" x 8"	<b>S8101080</b>	\$9,545.50
10" x 10"	<b>S8101010</b>	\$11,501.00
12" x 8"	<b>S8101280</b>	\$12,042.50
12" x 10"	<b>S8101210</b>	\$13,614.00
12" x 12"	<b>S8101212</b>	\$18,934.00
14" x 10"	<b>S8101410</b>	\$13,972.00
14" x 12"	<b>S8101412</b>	\$15,608.00
14" x 14"	<b>S8101414</b>	\$18,953.50
16" x 14"	<b>S8101614</b>	\$19,506.50

Orders for items in shaded areas **cannot** be cancelled or returned.

**Technical Data Sheet: G410**

Introduction
Couplings & Fittings
Mechanical Tees
Valves
Circuit Balancing Valves
Accessories
Copper Systems
Stainless Steel Systems
Plain End Systems
Stainless Steel G-PRESS
HDPE Systems
Gaskets & Spare Parts
Preparation Equipment
Miscellaneous
Indices

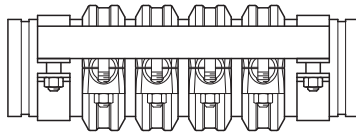
**#7550 – Expansion Joint**

Nominal Size	Number of Couplings per Expansion Joint	Movement (inches)			Painted Couplings and Black Pipe			Galvanized Couplings and Pipe		
		Maximum	Compressed	Expanded	Grade "E" EPDM	Grade "T" Nitrile	List Price	Grade "E" EPDM	Grade "T" Nitrile	List Price
1 1/4" with Fig. 705 Coupling	8	1.00	26.625	27.625	7550-1-13	7550-1-13T	POA	7550-1-13G	7550-1-13GT	POA
	10	1.25	31.375	32.625	7550-13-13	7550-13-13T	POA	7550-13-13G	7550-13-13GT	POA
	12	1.50	36.125	37.625	7550-15-13	7550-15-13T	POA	7550-15-13G	7550-15-13GT	POA
	14	1.75	40.875	42.625	7550-75-13	7550-75-13T	POA	7550-75-13G	7550-75-13GT	POA
1 1/2" with Fig. 705 Coupling	8	1.00	26.625	27.625	7550-1-15	7550-1-15T	POA	7550-1-15G	7550-1-15GT	POA
	10	1.25	31.375	32.625	7550-13-15	7550-13-15T	POA	7550-13-15G	7550-13-15GT	POA
	12	1.50	36.125	37.625	7550-15-15	7550-15-15T	POA	7550-15-15G	7550-15-15GT	POA
	14	1.75	40.875	42.625	7550-75-15	7550-75-15T	POA	7550-75-15G	7550-75-15GT	POA
2" with Fig. 705 Coupling	8	1.00	26.625	27.625	7550-1-20	7550-1-20T	POA	7550-1-20G	7550-1-20GT	POA
	10	1.25	31.375	32.625	7550-13-20	7550-13-20T	POA	7550-13-20G	7550-13-20GT	POA
	12	1.50	36.125	37.625	7550-15-20	7550-15-20T	POA	7550-15-20G	7550-15-20GT	POA
	14	1.75	40.875	42.625	7550-75-20	7550-75-20T	POA	7550-75-20G	7550-75-20GT	POA
2 1/2" with Fig. 705 Coupling	8	1.00	26.625	27.625	7550-1-25	7550-1-25T	POA	7550-1-25G	7550-1-25GT	POA
	10	1.25	31.375	32.625	7550-13-25	7550-13-25T	POA	7550-13-25G	7550-13-25GT	POA
	12	1.50	36.125	37.625	7550-15-25	7550-15-25T	POA	7550-15-25G	7550-15-25GT	POA
	14	1.75	40.875	42.625	7550-75-25	7550-75-25T	POA	7550-75-25G	7550-75-25GT	POA
3" with Fig. 705 Coupling	8	1.00	26.625	27.625	7550-1-30	7550-1-30T	POA	7550-1-30G	7550-1-30GT	POA
	10	1.25	31.375	32.625	7550-13-30	7550-13-30T	POA	7550-13-30G	7550-13-30GT	POA
	12	1.50	36.125	37.625	7550-15-30	7550-15-30T	POA	7550-15-30G	7550-15-30GT	POA
	14	1.75	40.875	42.625	7550-75-30	7550-75-30T	POA	7550-75-30G	7550-75-30GT	POA
4" with Fig. 705 Coupling	4	1.00	17.500	18.500	7550-1-40	7550-1-40T	POA	7550-1-40G	7550-1-40GT	POA
	5	1.25	20.000	21.250	7550-13-40	7550-13-40T	POA	7550-13-40G	7550-13-40GT	POA
	6	1.50	22.500	24.000	7550-15-40	7550-15-40T	POA	7550-15-40G	7550-15-40GT	POA
	7	1.75	25.000	26.750	7550-75-40	7550-75-40T	POA	7550-75-40G	7550-75-40GT	POA
5" with Fig. 705 Coupling	4	1.00	17.500	18.500	7550-1-50	7550-1-50T	POA	7550-1-50G	7550-1-50GT	POA
	5	1.25	20.000	21.250	7550-13-50	7550-13-50T	POA	7550-13-50G	7550-13-50GT	POA
	6	1.50	22.500	24.000	7550-15-50	7550-15-50T	POA	7550-15-50G	7550-15-50GT	POA
	7	1.75	25.000	26.750	7550-75-50	7550-75-50T	POA	7550-75-50G	7550-75-50GT	POA
6" with Fig. 705 Coupling	4	1.00	17.500	18.500	7550-1-60	7550-1-60T	POA	7550-1-60G	7550-1-60GT	POA
	5	1.25	20.000	21.250	7550-13-60	7550-13-60T	POA	7550-13-60G	7550-13-60GT	POA
	6	1.50	22.500	24.000	7550-15-60	7550-15-60T	POA	7550-15-60G	7550-15-60GT	POA
	7	1.75	25.000	26.750	7550-75-60	7550-75-60T	POA	7550-75-60G	7550-75-60GT	POA
8" with Fig. 705 Coupling	4	1.00	19.125	20.125	7550-1-80	7550-1-80T	POA	7550-1-80G	7550-1-80GT	POA
	5	1.25	22.000	23.250	7550-13-80	7550-13-80T	POA	7550-13-80G	7550-13-80GT	POA
	6	1.50	24.875	26.375	7550-15-80	7550-15-80T	POA	7550-15-80G	7550-15-80GT	POA
	7	1.75	27.500	29.500	7550-75-80	7550-75-80T	POA	7550-75-80G	7550-75-80GT	POA

See latest catalog or technical data sheets for specific approvals, listings, and design parameters.  
 POA = Price on availability. Prices subject to change without notice.

Customer Service: (800) 558-5236

[www.grinnell.com](http://www.grinnell.com)



**#7550 – Expansion Joint**

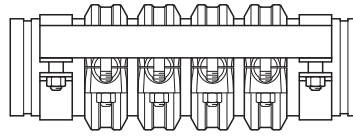

Nominal Size	Number of Couplings per Expansion Joint	Movement (inches)			Painted Couplings and Black Pipe			Galvanized Couplings and Pipe		
		Maximum	Compressed	Expanded	Grade "E" EPDM	Grade "T" Nitrile	List Price	Grade "E" EPDM	Grade "T" Nitrile	List Price
10" with Fig. 705 Coupling	4	1.00	21.500	22.500	7550-1-10	7550-1-10T	POA	7550-1-10G	7550-1-10GT	POA
	5	1.25	24.500	25.750	7550-13-10	7550-13-10T	POA	7550-13-10G	7550-13-10GT	POA
	6	1.50	27.500	29.000	7550-15-10	7550-15-10T	POA	7550-15-10G	7550-15-10GT	POA
	7	1.75	30.500	32.250	7550-75-10	7550-75-10T	POA	7550-75-10G	7550-75-10GT	POA
12" with Fig. 705 Coupling	4	1.00	21.500	22.500	7550-1-12	7550-1-12T	POA	7550-1-12G	7550-1-12GT	POA
	5	1.25	24.500	25.750	7550-13-12	7550-13-12T	POA	7550-13-12G	7550-13-12GT	POA
	6	1.50	27.500	29.000	7550-15-12	7550-15-12T	POA	7550-15-12G	7550-15-12GT	POA
	7	1.75	30.500	32.250	7550-75-12	7550-75-12T	POA	7550-75-12G	7550-75-12GT	POA
14" with Fig. 707 Coupling	4	1.00	23.125	24.125	7550-1-14	7550-1-14T	POA	7550-1-14G	7550-1-14GT	POA
	5	1.25	26.500	27.750	7550-13-14	7550-13-14T	POA	7550-13-14G	7550-13-14GT	POA
	6	1.50	29.875	31.375	7550-15-14	7550-15-14T	POA	7550-15-14G	7550-15-14GT	POA
	7	1.75	33.250	35.000	7550-75-14	7550-75-14T	POA	7550-75-14G	7550-75-14GT	POA
16" with Fig. 707 Coupling	4	1.00	24.125	25.125	7550-1-16	7550-1-16T	POA	7550-1-16G	7550-1-16GT	POA
	5	1.25	27.500	28.750	7550-13-16	7550-13-16T	POA	7550-13-16G	7550-13-16GT	POA
	6	1.50	30.875	32.375	7550-15-16	7550-15-16T	POA	7550-15-16G	7550-15-16GT	POA
	7	1.75	34.250	36.000	7550-75-16	7550-75-16T	POA	7550-75-16G	7550-75-16GT	POA

1. Factory present needs to be denoted at the time of sale as fully expanded, fully compressed, or intermediate % of movement from compressed position.
2. Expansion Joints can be provided with any of the following option combinations as a special order.

**Gasket Material:** "E" EPDM, "T" Nitrile, "O" Fluoroelastomer, or "L" Silicone

**Pipe Finish:** black, galvanized, or stainless steel

**Coupling Finish:** painted, galvanized, or stainless steel

For specific coupling specifications refer to appropriate coupling technical datasheet.

Consult with your Tyco Mechanical Products Sales representative before ordering.

Orders for items in shaded areas **cannot** be cancelled or returned.

**Technical Data Sheet: G460**

Introduction  
Couplings & Fittings  
Mechanical Tees  
Valves  
Circuit Balancing Valves  
Accessories  
Copper Systems  
Stainless Steel Systems  
Plain End Systems  
Stainless Steel G-PRESS  
HDPE Systems  
Gaskets & Spare Parts  
Preparation Equipment  
Miscellaneous  
Indices

**#640 Pivot-Bolt Rigid Couplings**  
**with Grade “EHT” EPDM Center-Stop Push-On Style Gasket**

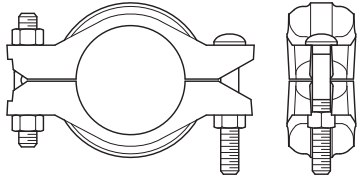
	<i>Nominal Size</i>	<i>Part Number</i>	<i>List Price</i>
	2"	64020EHT	\$58.50
	2½"	64025EHT	\$66.00
	3"	64030EHT	\$74.00
	4"	64040EHT	\$111.00
	5"	64050EHT	\$186.50
	6"	64060EHT	\$246.00
	8"	64080EHT	\$381.50
<b>Technical Data Sheet: G512</b>			

**#672 Rigid Couplings**  
**with Grade “EN” Tri-Seal Gasket**

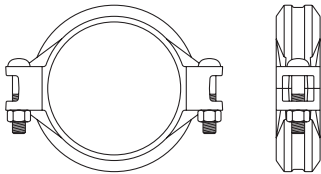
	<i>Nominal Size</i>	<i>Part Number</i>	<i>List Price</i>
	2"	67220EN3	\$58.50
	2½"	67225EN3	\$66.00
	3"	67230EN3	\$74.00
	4"	67240EN3	\$111.00
	5"	67250EN3	\$186.50
	6"	67260EN3	\$246.00
	8"	67280EN3	\$381.50
<b>Technical Data Sheet: G510</b>			

**#616 Reducing Coupling**  
**with Grade “EN” EPDM Gasket**

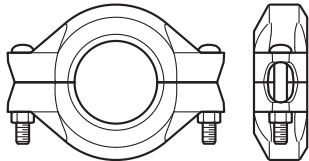
	<i>Nominal Size</i>	<i>Part Number</i>	<i>List Price</i>
	2½" x 2"	6162520ENP	\$230.00
	3" x 2"	6163020ENP	\$240.00
	3" x 2½"	6163025ENP	\$245.00
	4" x 2½"	6164025ENP	\$425.00
	4" x 3"	6164030ENP	\$435.00
	5" x 4"	6165040ENP	\$1,160.00
	6" x 4"	6166040ENP	\$1,250.00
<b>Technical Data Sheet: G511</b>			

**#617 Transition Coupling for Joining IPS to Copper Tubing Systems  
 with Grade “EN” EPDM Gasket**

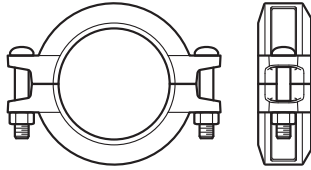

<i>Nominal Size</i>	<i>Part Number</i>	<i>List Price</i>
2"	61720ENP	\$295.00
2½"	61725ENP	\$300.00
3"	61730ENP	\$395.00
4"	61740ENP	\$750.00

Technical Data Sheet: G513

**#61H Flange Adapter – Hinged  
 with Grade “EN” EPDM Gasket**

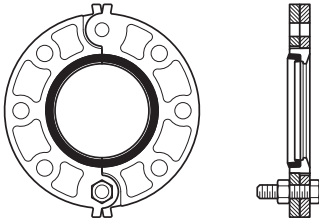

<i>Nominal Size</i>	<i>Part Number</i>	<i>List Price</i>
2"	61H20ENP	\$445.50
2½"	61H25ENP	\$464.00
3"	61H30ENP	\$486.00
4"	61H40ENP	\$533.00
5"	61H50ENP	\$716.50
6"	61H60ENP	\$779.50

Technical Data Sheet: G516

**#61 Flange Adapter  
 with Grade “EN” EPDM Gasket**

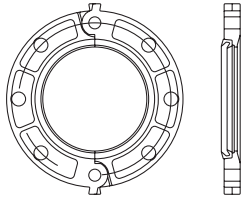

<i>Nominal Size</i>	<i>Part Number</i>	<i>List Price</i>
2"	6120EN	\$445.50
2½"	6125EN	\$464.00
3"	6130EN	\$486.00
4"	6140EN	\$533.00
5"	6150EN	\$716.50
6"	6160EN	\$779.50

Technical Data Sheet: G515

Introduction  
 Couplings & Fittings  
 Mechanical Tees  
 Valves  
 Circuit Balancing Valves  
 Accessories  
 Copper Systems  
 Stainless Steel Systems  
 Plain End Systems  
 Stainless Steel G-PRESS  
 HDPE Systems  
 Gaskets & Spare Parts  
 Preparation Equipment  
 Miscellaneous  
 Indices

**#610 Grooved 90° Elbow**

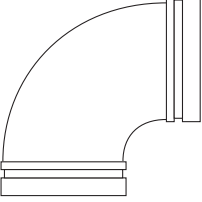
	Nominal Size	Part Number	List Price
	2"	61020S	\$103.00
	2½"	61025S	\$111.50
	3"	61030S	\$156.50
	4"	61040S	\$359.00
	5"	61050S	\$1,018.50
	6"	61060S	\$1,625.50
	8"	61080S	\$3,052.00

**Technical Data Sheet: G520**
**#601 Grooved 45° Elbow**

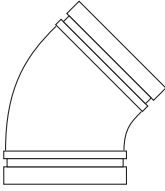
	Nominal Size	Part Number	List Price
	2"	64520S	\$103.00
	2½"	64525S	\$111.50
	3"	64530S	\$156.50
	4"	64540S	\$359.00
	5"	64550S	\$1,018.50
	6"	64560S	\$1,625.50
	8"	64580S	\$3,052.00

 Orders for items in shaded areas *cannot* be cancelled or returned.

**Technical Data Sheet: G520**
**#619 Tee**

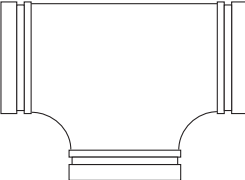
	Nominal Size	Part Number	List Price
	2"	61920S	\$169.00
	2½"	61925S	\$179.50
	3"	61930S	\$267.00
	4"	61940S	\$586.00
	5"	61950S	\$1,640.00
	6"	61960S	\$2,026.50
	8"	61980S	\$3,619.00

**Technical Data Sheet: G520**
**#660 Cap**

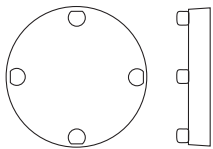
	Nominal Size	Part Number	List Price
	2"	66020S	\$71.00
	2½"	66025S	\$105.50
	3"	66030S	\$131.00
	4"	66040S	\$196.50
	5"	66050S	\$221.50
	6"	66060S	\$401.00
	8"	66080S	POA

 Orders for items in shaded areas *cannot* be cancelled or returned.

**Technical Data Sheet: G520**

**#650 Grooved Concentric Reducer**

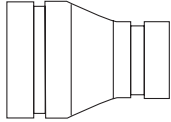

<i>Nominal Size</i>	<i>Part Number</i>	<i>List Price</i>
2½" x 2"	6502520	\$148.00
3" x 2"	6503020	\$148.00
3" x 2½"	6503025	\$148.00
4" x 2"	6504020	\$302.50
4" x 2½"	6504025	\$302.50
4" x 3"	6504030	\$302.50
5" x 3"	6505030	\$851.50
5" x 4"	6505040	\$851.50
6" x 3"	6506030	\$922.00
6" x 4"	6506040	\$922.00
6" x 5"	6506050	\$922.00
8" x 6"	6508060	\$1,618.00

Orders for items in shaded areas *cannot* be cancelled or returned.

**Technical Data Sheet: G520**

**#652 Grooved Reducer  
Grooved x Cup**

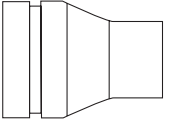

<i>Nominal Size</i>	<i>Part Number</i>	<i>List Price</i>
2" x 1"	6522010W	\$122.50
2" x 1¼"	6522013W	\$122.50
2" x 1½"	6522015W	\$122.50
2½" x 1"	6522510W	\$150.00
2½" x 1¼"	6522513W	\$150.00
2½" x 1½"	6522515W	\$150.00
2½" x 2"	6522520W	\$150.00
3" x 1½"	6523015W	\$186.00
3" x 2"	6523020W	\$186.00
4" x 2"	6524020W	\$345.50

**Technical Data Sheet: G520**

**#621 Reducing Tee  
Grooved x Grooved x Grooved**

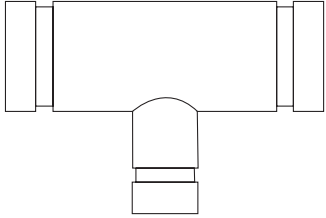

<i>Nominal Size</i>	<i>Part Number</i>	<i>List Price</i>
2½" x 2½" x 2"	6212520	\$267.50
3" x 3" x 2"	6213020	\$344.50
3" x 3" x 2½"	6213025	\$454.50
4" x 4" x 2"	6214020	\$770.00
4" x 4" x 2½"	6214025	\$770.00
4" x 4" x 3"	6214030	\$770.00
5" x 5" x 3"	6215030	\$2,350.50
5" x 5" x 4"	6215040	\$2,350.50
6" x 6" x 2½"	6216025	\$2,870.00
6" x 6" x 3"	6216030	\$2,870.00
6" x 6" x 4"	6216040	\$2,870.00
6" x 6" x 5"	6216050	\$2,870.00

Orders for items in shaded areas *cannot* be cancelled or returned.

**Technical Data Sheet: G520**

Introduction  
Couplings & Fittings  
Mechanical Tees  
Valves  
Circuit Balancing Valves  
Accessories  
Copper Systems  
Stainless Steel Systems  
Plain End Systems  
Stainless Steel G-PRESS  
HDPE Systems  
Gaskets & Spare Parts  
Preparation Equipment  
Miscellaneous  
Indices

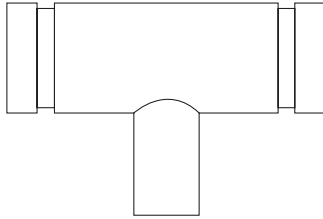
**#618 Reducing Tee**  
**Grooved x Grooved x Cup**

<i>Nominal Size</i>	<i>Part Number</i>	<i>List Price</i>
2" x 2" x 3/4"	<b>61820075</b>	\$216.50
2" x 2" x 1"	<b>6182010</b>	\$216.50
2" x 2" x 1 1/4"	<b>6182013</b>	\$216.50
2" x 2" x 1 1/2"	<b>6182015</b>	\$216.50
2 1/2" x 2 1/2" x 3/4"	<b>61825075</b>	\$275.00
2 1/2" x 2 1/2" x 1"	<b>6182510</b>	\$268.50
2 1/2" x 2 1/2" x 1 1/4"	<b>6182513</b>	\$268.50
2 1/2" x 2 1/2" x 1 1/2"	<b>6182515</b>	\$268.50
3" x 3" x 3/4"	<b>61830075</b>	\$497.00
3" x 3" x 1"	<b>6183010</b>	\$497.00
3" x 3" x 1 1/4"	<b>6183013</b>	\$497.00
3" x 3" x 1 1/2"	<b>6183015</b>	\$497.00
4" x 4" x 3/4"	<b>61840075</b>	\$587.50
4" x 4" x 1"	<b>6184010</b>	\$770.00
4" x 4" x 1 1/4"	<b>6184013</b>	\$770.00
4" x 4" x 1 1/2"	<b>6184015</b>	\$770.00

 Orders for items in shaded areas **cannot** be cancelled or returned.

**Technical Data Sheet: G520**
**#407GG Dielectric Waterway Transition**  
**Fitting Grooved x Grooved, IPS x CTS**

<i>Nominal Size</i> <i>(Pipe Size x Length)</i>	<i>Part Number</i>	<i>List Price</i>
2" x 4 <sup>3</sup> / <sub>16</sub> " L	<b>41480</b>	\$171.50
2 1/2" x 6 <sup>3</sup> / <sub>16</sub> " L	<b>41474</b>	\$192.50
3" x 6 <sup>3</sup> / <sub>16</sub> " L	<b>41475</b>	\$295.00
4" x 6 <sup>3</sup> / <sub>16</sub> " L	<b>41476</b>	\$592.00
5" x 6 <sup>3</sup> / <sub>16</sub> " L	<b>41477</b>	\$661.00
6" x 6 <sup>3</sup> / <sub>16</sub> " L	<b>41478</b>	\$818.50

 Orders for items in shaded areas **cannot** be cancelled or returned.

**Technical Data Sheet: G465**
**#407GT Dielectric Waterway**  
**Grooved x Thread**



<i>Nominal Size</i> <i>(Pipe Size x Length)</i>	<i>Painted</i>	<i>List Price</i>
1" x 4" L	<b>41465</b>	\$64.00
1 1/4" x 4" L	<b>41466</b>	\$85.00
1 1/2" x 4" L	<b>41467</b>	\$99.50
2" x 4" L	<b>41468</b>	\$101.00
2 1/2" x 6" L	<b>41469</b>	\$136.50
3" x 6" L	<b>41470</b>	\$246.50
4" x 6" L	<b>41472</b>	\$329.50

**Technical Data Sheet: G465**

**#407T Dielectric Waterway  
Male Thread x Male Thread**

	Nominal Size (Pipe Size x Length)	Painted	List Price
	1/2" x 3" L	41455	\$35.50
	3/4" x 3" L	41456	\$35.50
	1" x 4" L	41457	\$52.00
	1 1/4" x 4" L	41458	\$74.00
	1 1/2" x 4" L	41459	\$89.00
	2" x 4" L	41460	\$101.00
	2 1/2" x 6" L	41461	\$136.50
	3" x 6" L	41462	\$246.50
4" x 6" L	41464	\$329.50	
<b>Technical Data Sheet: G465</b>			

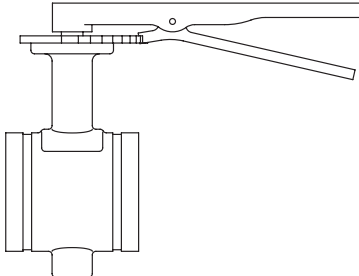
**#B680 Copper System Butterfly Valve  
Grooved, EPDM, with Lever Handle or Gear Operated**

	Nominal Size	Lever Handle		Gear Operated	
		Part Number	List Price	Part Number	List Price
	2"	68020EL	POA	68020EG	POA
	2 1/2"	68025EL	\$1,098.90	68025EG	\$1,799.60
	3"	68030EL	\$1,207.25	68030EG	\$1,906.30
	4"	68040EL	\$1,526.80	68040EG	\$2,228.05
	5"	68050EL	\$1,931.60	68050EG	\$2,640.00
6"	68060EL	\$2,075.70	68060EG	\$2,774.75	
Orders for items in shaded areas <b>cannot</b> be cancelled or returned.					
<b>Technical Data Sheet: G530</b>					

**Roll Groover Mini-Mite 2" – 8" Copper Tube  
#1039-66 Ratchet Hand Crank or Chucked into a Ridgid® 300**

	Nominal Size	Part Number	List Price
	2" – 8"	41047	\$815.50
<b>Technical Data Sheet: G720</b>			

Introduction  
Couplings & Fittings  
Mechanical Tees  
Valves  
Circuit Balancing Valves  
Accessories  
Copper Systems  
Stainless Steel Systems  
Plain End Systems  
Stainless Steel G-PRESS  
HDPE Systems  
Gaskets & Spare Parts  
Preparation Equipment  
Miscellaneous  
Indices

**#472 Rigid Coupling 316 SS**  
**with Grade “EN” or Grade “T” Nitrile Gasket**

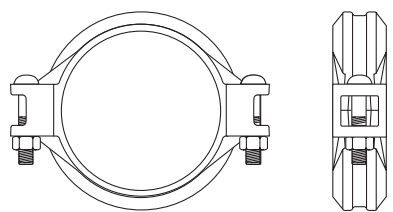
	Nominal Size	Part Number		List Price
		Grade “EN” EPDM	Grade “T” Nitrile	
	1 1/4"	47213EN	47213T	POA
	1 1/2"	47215EN	47215T	\$223.50
	2"	47220EN	47220T	\$250.00
	2 1/2"	47225EN	47225T	\$274.50
	3"	47230EN	47230T	\$306.50
	4"	47240EN	47240T	\$386.00
	5"	47250EN	47250T	POA
	6"	47260EN	47260T	\$891.50
	8"	47280EN	47280T	\$1,858.00
	10"	47210EN	47210T	\$2,189.50
	12"	47212EN	47212T	\$3,082.00

 Orders for items in shaded areas *cannot* be cancelled or returned.

**Technical Data Sheet: G560**
**#472 Rigid Coupling 316 SS**  
**with Grade “EN” or Grade “T” Nitrile Tri-seal Gasket**

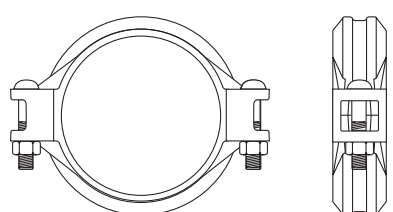
	Nominal Size	Part Number		List Price
		Grade “EN” EPDM	Grade “T” Nitrile	
	1 1/4"	47213EN3	47213T3	POA
	1 1/2"	47215EN3	47215T3	\$252.50
	2"	47220EN3	47220T3	\$291.00
	2 1/2"	47225EN3	47225T3	\$311.00
	3"	47230EN3	47230T3	\$341.50
	4"	47240EN3	47240T3	\$437.00
	5"	47250EN3	47250T3	POA
	6"	47260EN3	47260T3	\$1,201.00
	8"	47280EN3	47280T3	\$1,954.00
	10"	47210EN3	47210T3	\$2,312.50
	12"	47212EN3	47212T3	\$3,231.50

 Orders for items in shaded areas *cannot* be cancelled or returned.

**Technical Data Sheet: G560**

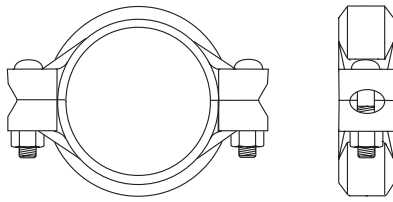

**#405 Flexible Coupling 316 SS**  
**with Grade “EN” or Grade “T” Nitrile Gasket**

	Nominal Size	Part Number		List Price
		Grade “EN” EPDM	Grade “T” Nitrile	
	1"	40501EN	40501T	\$171.50
	1 1/4"	40513EN	40513T	\$200.50
	1 1/2"	40515EN	40515T	\$223.50
	2"	40520EN	40520T	\$250.00
	2 1/2"	40525EN	40525T	\$274.50
	3"	40530EN	40530T	\$306.50
	4"	40540EN	40540T	\$386.00
	5"	40550EN	40550T	POA
	6"	40560EN	40560T	POA
	8"	40580EN	40580T	POA

Orders for items in shaded areas *cannot* be cancelled or returned.

**Technical Data Sheet: G565**

**#405 Flexible Coupling 316 SS**  
**with Grade “EN” or Grade “T” Nitrile Tri-Seal Gasket**

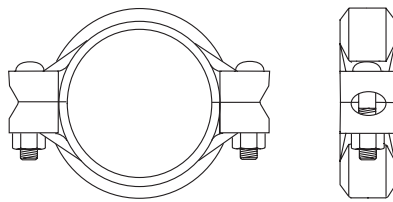
	Nominal Size	Part Number		List Price
		Grade “EN” EPDM	Grade “T” Nitrile	
	1 1/4"	40513EN3	40513T3	\$228.00
	1 1/2"	40515EN3	40515T3	\$252.00
	2"	40520EN3	40520T3	\$291.00
	2 1/2"	40525EN3	40525T3	\$311.00
	3"	40530EN3	40530T3	\$341.50
	4"	40540EN3	40540T3	\$437.00
	5"	40550EN3	40550T3	POA
	6"	40560EN3	40560T3	POA
	8"	40580EN3	40580T3	POA

Orders for items in shaded areas *cannot* be cancelled or returned.

**Technical Data Sheet: G565**

Introduction  
 Couplings & Fittings  
 Mechanical Tees  
 Valves  
 Circuit Balancing Valves  
 Accessories  
 Copper Systems  
 Stainless Steel Systems  
 Plain End Systems  
 Stainless Steel G-PRESS  
 HDPE Systems  
 Gaskets & Spare Parts  
 Preparation Equipment  
 Miscellaneous  
 Indices

**#410 90° Elbow**  
**304 SS & 316 SS, Schedule 10**

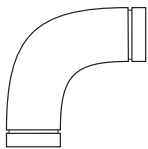
	Nominal Size	304 SS			316 SS		
		Domestic	Global	List Price	Domestic	Global	List Price
	1"	410014AD	410014A	POA	410016AD	410016A	\$140.50
	1¼"	410134AD	410134A	POA	410136AD	410136A	\$142.50
	1½"	410154AD	410154A	POA	410156AD	410156A	\$143.00
	2"	410204AD	410204A	POA	410206AD	410206A	\$160.50
	2½"	410254AD	410254A	POA	410256AD	410256A	\$217.50
	3"	410304AD	410304A	\$210.00	410306AD	410306A	\$260.50
	4"	410404AD	410404A	\$299.50	410406AD	410406A	\$373.00
	5"	410504AD	410504A	POA	410506AD	410506A	POA
	6"	410604AD	410604A	\$789.00	410606AD	410606A	\$984.50
	8"	410804AD	410804A	\$1,371.00	410806AD	410806A	\$1,711.00
	10"	410104AD	410104A	\$2,705.50	410106AD	410106A	\$3,380.50
	12"	410124AD	410124A	\$4,240.00	410126AD	410126A	\$5,298.00

 Orders for items in shaded areas *cannot* be cancelled or returned.

**Technical Data Sheet: G570**
**#401 45° Elbow,**  
**304 SS & 316 SS, Schedule 10**

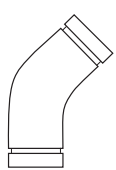
	Nominal Size	304 SS			316 SS		
		Domestic	Global	List Price	Domestic	Global	List Price
	1"	401014AD	401014A	POA	401016AD	401016A	\$127.00
	1¼"	401134AD	401134A	POA	401136AD	401136A	\$128.00
	1½"	401154AD	401154A	POA	401156AD	401156A	\$130.50
	2"	401204AD	401204A	POA	401206AD	401206A	\$143.00
	2½"	401254AD	401254A	POA	401256AD	401256A	\$188.50
	3"	401304AD	401304A	\$193.50	401306AD	401306A	\$240.00
	4"	401404AD	401404A	\$276.50	401406AD	401406A	\$343.50
	5"	401504AD	401504A	POA	401506AD	401506A	POA
	6"	401604AD	401604A	\$521.00	401606AD	401606A	\$650.50
	8"	401804AD	401804A	\$890.50	401806AD	401806A	\$1,113.00
	10"	401104AD	401104A	\$2,083.00	401106AD	401106A	\$2,436.00
	12"	401124AD	401124A	\$2,874.00	401126AD	401126A	\$3,592.50

 Orders for items in shaded areas *cannot* be cancelled or returned.

**Technical Data Sheet: G570**

## Tyco Mechanical Products Section 8 – Stainless Steel Systems

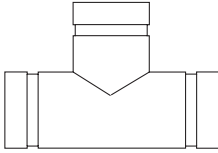

### #419 Tee, 304 SS & 316 SS, Schedule 10

	Nominal Size	304 SS			316 SS		
		Domestic	Global	List Price	Domestic	Global	List Price
	1"	419014AD	419014A	\$418.50	419016AD	419016A	\$436.00
	1 1/4"	419134AD	419134A	\$491.00	419136AD	419136A	POA
	1 1/2"	419154AD	419154A	POA	419156AD	419156A	\$407.50
	2"	419204AD	419204A	POA	419206AD	419206A	\$426.00
	2 1/2"	419254AD	419254A	POA	419256AD	419256A	\$519.00
	3"	419304AD	419304A	\$538.50	419306AD	419306A	\$672.50
	4"	419404AD	419404A	\$576.00	419406AD	419406A	\$720.00
	5"	419504AD	419504A	POA	419506AD	419506A	POA
	6"	419604AD	419604A	\$1,120.50	419606AD	419606A	\$1,571.50
	8"	419804AD	419804A	\$1,654.50	419806AD	419806A	\$2,921.50
	10"	419104AD	419104A	\$3,235.50	419106AD	419106A	\$7,462.00
	12"	419124AD	419124A	\$4,876.00	419126AD	419126A	\$9,513.00

Orders for items in shaded areas *cannot* be cancelled or returned.

**Technical Data Sheet: G570**

### #460 Cap, 304 SS & 316 SS, Schedule 10

	Nominal Size	304 SS			316 SS		
		Domestic	Global	List Price	Domestic	Global	List Price
	1"	460014AD	460014A	POA	460016AD	460016A	\$199.00
	1 1/4"	460134AD	460134A	POA	460136AD	460136A	\$210.50
	1 1/2"	460154AD	460154A	POA	460156AD	460156A	\$219.50
	2"	460204AD	460204A	POA	460206AD	460206A	\$301.50
	2 1/2"	460254AD	460254A	POA	460256AD	460256A	\$313.50
	3"	460304AD	460304A	POA	460306AD	460306A	\$379.50
	4"	460404AD	460404A	POA	460406AD	460406A	\$484.00
	5"	460504AD	460504A	POA	460506AD	460506A	POA
	6"	460604AD	460604A	POA	460606AD	460606A	\$578.00
	8"	460804AD	460804A	POA	460806AD	460806A	\$1,361.50
	10"	460104AD	460104A	POA	460106AD	460106A	\$1,782.50
	12"	460124AD	460124A	POA	460126AD	460126A	\$2,074.50

Orders for items in shaded areas *cannot* be cancelled or returned.

**Technical Data Sheet: G570**

Introduction  
Couplings & Fittings  
Mechanical Tees  
Valves  
Circuit Balancing Valves  
Accessories  
Copper Systems  
Stainless Steel Systems  
Plain End Systems  
Stainless Steel G-PRESS  
HDPE Systems  
Gaskets & Spare Parts  
Preparation Equipment  
Miscellaneous  
Indices

**#421 Reducing Tee,  
 304 SS & 316 SS, Schedule 10**

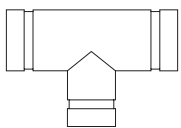
	Nominal Size	304 SS			316 SS		
		Domestic	Global	List Price	Domestic	Global	List Price
	1 1/2" x 1 1/2" x 1"	42115014AD	42115014A	\$367.50	42115016AD	42115016A	\$451.50
	1 1/2" x 1 1/2" x 1 1/4"	42115134AD	42115134A	\$375.50	42115136AD	42115136A	\$462.00
	2" x 2" x 1"	42120014AD	42120104A	\$396.00	42120016AD	42120016A	\$466.50
	2" x 2" x 1 1/4"	42120134AD	42120134A	\$445.00	42120136AD	42120136A	\$605.50
	2" x 2" x 1 1/2"	42120154AD	42120154A	\$503.00	42120156AD	42120156A	\$605.50
	2 1/2" x 2 1/2" x 1"	42125014AD	42125104A	\$504.00	42125016AD	42125016A	\$619.00
	2 1/2" x 2 1/2" x 1 1/2"	42125154AD	42125154A	\$569.00	42125156AD	42125156A	\$621.50
	2 1/2" x 2 1/2" x 2"	42125204AD	42125204A	POA	42125206AD	42125206A	\$612.00
	3" x 3" x 1"	42130014AD	42130014A	\$504.50	42130016AD	42130016A	\$578.50
	3" x 3" x 1 1/4"	42130134AD	42130134A	\$597.50	42130136AD	42130136A	\$712.00
	3" x 3" x 1 1/2"	42130154AD	42130154A	\$621.50	42130156AD	42130156A	\$747.50
	3" x 3" x 2"	42130204AD	42130204A	\$666.00	42130206AD	42130206A	POA
	3" x 3" x 2 1/2"	42130254AD	42130254A	\$641.50	42130256AD	42130256A	\$798.50
	4" x 4" x 2"	42140204AD	42140204A	\$754.50	42140206AD	42140206A	\$902.50
	4" x 4" x 2 1/2"	42140254AD	42140254A	POA	42140256AD	42140256A	\$965.50
	4" x 4" x 3"	42140304AD	42140304A	\$885.50	42140306AD	42140306A	\$1,104.50
	6" x 6" x 1 1/2"	42160154AD	42160154A	POA	42160156AD	42160156A	POA
	6" x 6" x 2"	42160204AD	42160204A	POA	42160206AD	42160206A	\$1,883.50
	6" x 6" x 3"	42160304AD	42160304A	\$1,141.50	42160306AD	42160306A	\$1,424.50
6" x 6" x 4"	42160404AD	42160404A	\$1,415.00	42160406AD	42160406A	\$1,689.00	
8" x 8" x 4"	42180404AD	42180404A	\$3,333.00	42180406AD	42180406A	\$3,978.50	
8" x 8" x 6"	42180604AD	42180604A	\$4,369.00	42180606AD	42180606A	\$5,356.00	
10" x 10" x 6"	42110604AD	42110604A	\$5,330.50	42110606AD	42110606A	\$6,795.00	
10" x 10" x 8"	42110804AD	42110804A	\$5,377.50	42110806AD	42110806A	\$6,854.00	
12" x 12" x 8"	42112804AD	42112804A	\$7,683.00	42112806AD	42112806A	\$9,589.50	
12" x 12" x 10"	42112104AD	42112104A	\$9,183.50	42112106AD	42112106A	\$11,460.50	

 Orders for items in shaded areas **cannot** be cancelled or returned.

**Technical Data Sheet: G570**
**#441 Flange Adapter Nipple 150 lbs.  
 304 SS & 316 SS, Schedule 10**

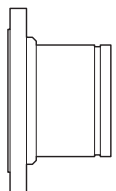
	Nominal Size	304 SS		316 SS	
		Part Number	List Price	Part Number	List Price
	2"	441204	\$705.00	441206	\$717.50
	2 1/2"	441254	\$992.00	441256	\$1,070.50
	3"	441304	\$1,024.00	441306	\$1,105.50
	4"	441404	\$1,431.50	441406	\$1,545.50
	6"	441604	\$1,927.00	441606	\$2,061.00
	8"	441804	\$2,631.50	441806	\$3,153.50

 Orders for items in shaded areas **cannot** be cancelled or returned.

**Technical Data Sheet: G568**

 For domestically-made fittings, contact your local Tyco Mechanical Products sales representative.  
 See latest catalog or technical data sheets for specific approvals, listings, and design parameters.  
 POA = Price on availability. Prices subject to change without notice.

# Tyco Mechanical Products

## Section 8 – Stainless Steel Systems



### #450 Concentric Reducer, 304 SS & 316 SS, Schedule 10

Nominal Size	304 SS			316 SS		
	Domestic	Global	List Price	Domestic	Global	List Price
1 1/2" x 1"	45015014AD	45015014A	\$260.00	45015016AD	45015016A	\$302.50
1 1/2" x 1 1/4"	45015134AD	45015134A	\$289.00	45015136AD	45015136A	\$315.00
2" x 1"	45020014AD	45020104A	\$210.50	45020016AD	45020016A	\$249.00
2" x 1 1/4"	45020134AD	45020134A	\$584.50	45020136AD	45020136A	\$739.00
2" x 1 1/2"	45020154AD	45020154A	POA	45020156AD	45020156A	\$286.00
2 1/2" x 1 1/2"	45025154AD	45025154A	\$565.00	45025156AD	45025156A	\$605.00
2 1/2" x 2"	45025204AD	45025204A	POA	45025206AD	45025206A	\$359.00
3" x 1"	45030014AD	45030014A	\$602.50	45030016AD	45030016A	\$785.50
3" x 1 1/4"	45030134AD	45030134A	\$866.00	45030136AD	45030136A	POA
3" x 1 1/2"	45030154AD	45030154A	\$589.50	45030156AD	45030156A	\$703.00
3" x 2"	45030204AD	45030204A	\$188.00	45030206AD	45030206A	\$277.50
3" x 2 1/2"	45030254AD	45030254A	\$154.00	45030256AD	45030256A	\$191.50
4" x 2"	45040204AD	45040204A	\$250.50	45040206AD	45040206A	\$438.00
4" x 2 1/2"	45040254AD	45040254A	\$343.50	45040256AD	45040256A	\$646.00
4" x 3"	45040304AD	45040304A	\$178.00	45040306AD	45040306A	\$222.50
5" x 3"	45050304AD	45050304A	POA	45050306AD	45050306A	POA
5" x 4"	45050404AD	45050404A	POA	45050406AD	45050406A	POA
6" x 2"	45060204AD	45060204A	POA	45060206AD	45060206A	POA
6" x 2 1/2"	45060254AD	45060254A	\$2,883.50	45060256AD	45060256A	\$3,644.50
6" x 3"	45060304AD	45060304A	\$576.00	45060306AD	45060306A	\$718.50
6" x 4"	45060404AD	45060404A	\$438.00	45060406AD	45060406A	\$545.50
6" x 5"	45060504AD	45060504A	\$1,679.00	-	-	-
8" x 3"	45080304AD	45080304A	POA	45080306AD	45080306A	POA
8" x 4"	45080404AD	45080404A	\$2,098.50	45080406AD	45080406A	\$2,622.50
8" x 6"	45080604AD	45080604A	\$1,101.00	45080606AD	45080606A	\$1,374.00
10" x 4"	45010404AD	45010404A	POA	45010406AD	45010406A	POA
10" x 6"	45010604AD	45010604A	\$2,598.50	45010606AD	45010606A	\$3,248.00
10" x 8"	45010804AD	45010804A	\$2,903.00	45010806AD	45010806A	\$3,628.00
12" x 6"	45012604AD	45012604A	POA	45012606AD	45012606A	POA
12" x 8"	45012804AD	45012804A	\$3,954.50	45012806AD	45012806A	\$4,942.00
12" x 10"	45012104AD	45012104A	\$3,634.00	45012106AD	45012106A	\$4,541.00

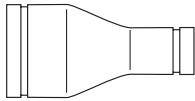

Orders for items in shaded areas **cannot** be cancelled or returned.

#### Technical Data Sheet: G570

Introduction  
Couplings & Fittings  
Mechanical Tees  
Valves  
Circuit Balancing Valves  
Accessories  
Copper Systems  
Stainless Steel Systems  
Plain End Systems  
Stainless Steel G-PRESS  
HDPE Systems  
Gaskets & Spare Parts  
Preparation Equipment  
Miscellaneous  
Indices

**#451 Eccentric Reducer,  
 304 SS & 316 SS, Schedule 10**

Nominal Size	304 SS			316 SS		
	Domestic	Global	List Price	Domestic	Global	List Price
1 1/4" x 1"	45113014AD	45113014A	POA	45113016AD	45113016A	POA
1 1/2" x 1"	45115014AD	45115014A	\$567.50	45115016AD	45115016A	\$652.50
1 1/2" x 1 1/4"	45115134AD	45115134A	POA	45115136AD	45115136A	POA
2" x 1"	45120014AD	45120014A	\$1,136.50	45120016AD	45120016A	\$1,136.50
2" x 1 1/4"	45120134AD	45120134A	\$1,222.50	45120136AD	45120136A	\$1,304.50
2" x 1 1/2"	45120154AD	45120154A	\$644.50	45120156AD	45120156A	\$739.00
2 1/2" x 2"	45125204AD	45125204A	\$784.00	45125206AD	45125206A	\$956.00
3" x 1"	45130014AD	45130014A	POA	45130016AD	45130016A	POA
3" x 2"	45130204AD	45130204A	\$793.00	45130206AD	45130206A	\$863.50
3" x 2 1/2"	45130254AD	45130254A	\$806.50	45130256AD	45130256A	\$925.50
4" x 2"	45140204AD	45140204A	\$2,122.50	45140206AD	45140206A	\$3,077.00
4" x 2 1/2"	45140254AD	45140254A	\$989.00	45140256AD	45140256A	\$1,680.00
4" x 3"	45140304AD	45140304A	\$1,648.00	45140306AD	45140306A	\$2,057.00
5" x 3"	45150304AD	45150304A	POA	45150306AD	45150306A	POA
5" x 4"	45150404AD	45150404A	POA	45150406AD	45150406A	POA
6" x 2"	45160204AD	45160204A	POA	45160206AD	45160206A	POA
6" x 2 1/2"	45160254AD	45160254A	\$2,883.50	45160256AD	45160256A	POA
6" x 3"	45160304AD	45160304A	\$4,762.00	45160306AD	45160306A	POA
6" x 4"	45160404AD	45160404A	\$1,738.50	45160406AD	45160406A	\$2,543.00
8" x 3"	45180304AD	45180304A	POA	45180306AD	45180306A	POA
8" x 4"	45180404AD	45180404A	POA	45180406AD	45180406A	POA
8" x 6"	45180604AD	45180604A	POA	45180606AD	45180606A	POA
10" x 6"	45110604AD	45110604A	POA	45110606AD	45110606A	POA
10" x 8"	45110804AD	45110804A	POA	45110806AD	45110806A	POA
12" x 6"	45112604AD	45112604A	POA	45112606AD	45112606A	POA
12" x 8"	45112804AD	45112804A	POA	45112806AD	45112806A	POA
12" x 10"	45112104AD	45112104A	POA	45112106AD	45112106A	POA



 Orders for items in shaded areas *cannot* be cancelled or returned.

**Technical Data Sheet: G570**

## Tyco Mechanical Products Section 8 – Stainless Steel Systems

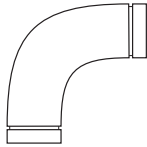

### #410 90° Elbow, Long Radius, 304 SS & 316 SS, Schedule 40



Nominal Size	304 SS			316 SS		
	Domestic	Global	List Price	Domestic	Global	List Price
1"	410014AD40	410014A40	\$448.50	410016AD40	410016A40	\$560.50
1 1/4"	410134AD40	410134A40	\$455.50	410136AD40	410136A40	\$569.00
1 1/2"	410154AD40	410154A40	\$457.00	410156AD40	410156A40	\$571.00
2"	410204AD40	410204A40	\$800.50	410206AD40	410206A40	\$1,000.50
2 1/2"	410254AD40	410254A40	\$909.00	410256AD40	410256A40	\$1,136.50
3"	410304AD40	410304A40	\$1,079.00	410306AD40	410306A40	\$1,348.50
4"	410404AD40	410404A40	\$1,381.50	410406AD40	410406A40	\$1,727.50
6"	410604AD40	410604A40	\$2,535.00	410606AD40	410606A40	\$3,168.50
8"	410804AD40	410804A40	\$3,918.00	410806AD40	410806A40	\$4,897.00
10"	410104AD40	410104A40	\$6,662.00	410106AD40	410106A40	\$8,327.00
12"	410124AD40	410124A40	\$9,034.00	410126AD40	410126A40	\$11,292.00

Orders for items in shaded areas **cannot** be cancelled or returned.

**Technical Data Sheet: G570**

### #401 45° Elbow, Long Radius, 304 SS & 316 SS, Schedule 40



Nominal Size	304 SS			316 SS		
	Domestic	Global	List Price	Domestic	Global	List Price
1"	401014AD40	401014A40	\$425.50	401016AD40	401016A40	\$532.50
1 1/4"	401134AD40	401134A40	\$433.00	401136AD40	401136A40	\$540.50
1 1/2"	401154AD40	401154A40	\$435.00	401156AD40	401156A40	\$543.50
2"	401204AD40	401204A40	\$791.00	401206AD40	401206A40	\$988.50
2 1/2"	401254AD40	401254A40	\$890.00	401256AD40	401256A40	\$1,112.00
3"	401304AD40	401304A40	\$999.00	401306AD40	401306A40	\$1,249.50
4"	401404AD40	401404A40	\$1,230.50	401406AD40	401406A40	\$1,537.50
6"	401604AD40	401604A40	\$1,998.00	401606AD40	401606A40	\$2,497.50
8"	401804AD40	401804A40	\$3,084.50	401806AD40	401806A40	\$3,856.00
10"	401104AD40	401104A40	\$4,687.00	401106AD40	401106A40	\$5,757.50
12"	401124AD40	401124A40	\$4,637.50	401126AD40	401126A40	\$5,797.00

Orders for items in shaded areas **cannot** be cancelled or returned.

**Technical Data Sheet: G570**

Introduction  
Couplings & Fittings  
Mechanical Tees  
Valves  
Circuit Balancing Valves  
Accessories  
Copper Systems  
Stainless Steel Systems  
Plain End Systems  
Stainless Steel G-PRESS  
HDPE Systems  
Gaskets & Spare Parts  
Preparation Equipment  
Miscellaneous  
Indices

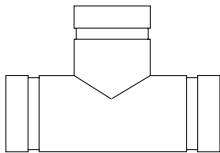
**#419 Tee,  
 304 SS & 316 SS, Schedule 40**

Nominal Size	304 SS			316 SS		
	Domestic	Global	List Price	Domestic	Global	List Price
1"	419014AD40	419014A40	\$1,120.00	419016AD40	419016A40	\$1,400.00
1 1/4"	419134AD40	419134A40	\$1,136.50	419136AD40	419136A40	\$1,421.00
1 1/2"	419154AD40	419154A40	\$1,153.00	419156AD40	419156A40	\$1,441.50
2"	419204AD40	419204A40	\$1,284.50	419206AD40	419206A40	\$1,606.50
2 1/2"	419254AD40	419254A40	\$1,350.50	419256AD40	419256A40	\$1,688.50
3"	419304AD40	419304A40	\$1,548.00	419306AD40	419306A40	\$1,935.50
4"	419404AD40	419404A40	\$2,272.50	419406AD40	419406A40	\$2,840.50
6"	419604AD40	419604A40	\$3,919.00	419606AD40	419606A40	\$4,898.00
8"	419804AD40	419804A40	\$4,281.50	419806AD40	419806A40	\$5,351.00
10"	419104AD40	419104A40	\$9,925.00	419106AD40	419106A40	\$12,406.00
12"	419124AD40	419124A40	\$12,652.00	419126AD40	419126A40	\$15,815.00

 Orders for items in shaded areas *cannot* be cancelled or returned.

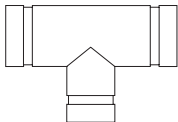
**Technical Data Sheet: G570**
**#421 Reducing Tee,  
 304 SS & 316 SS, Schedule 40**

Nominal Size	304 SS			316 SS		
	Domestic	Global	List Price	Domestic	Global	List Price
1 1/2" x 1 1/2" x 1"	42115014AD40	42115014A40	POA	42115016AD40	42115016A40	POA
1 1/2" x 1 1/2" x 1 1/4"	42115134AD40	42115134A40	POA	42115136AD40	42115136A40	POA
2" x 2" x 1"	42120104AD40	42120104A40	\$1,582.50	42120106AD40	42120106A40	\$1,978.00
2" x 2" x 1 1/4"	42120134AD40	42120134A40	\$1,778.50	42120136AD40	42120136A40	\$2,222.50
2" x 2" x 1 1/2"	42120154AD40	42120154A40	\$2,009.50	42120156AD40	42120156A40	\$2,511.50
2 1/2" x 2 1/2" x 1"	42125104AD40	42125104A40	POA	42125106AD40	42125106A40	POA
2 1/2" x 2 1/2" x 1 1/2"	42125154AD40	42125154A40	\$2,274.50	42125156AD40	42125156A40	\$2,843.50
2 1/2" x 2 1/2" x 2"	42125204AD40	42125204A40	\$2,535.50	42125206AD40	42125206A40	\$3,169.00
3" x 3" x 1"	42130014AD40	42130014A40	POA	42130016AD40	42130016A40	POA
3" x 3" x 1 1/4"	42130134AD40	42130134A40	POA	42130136AD40	42130136A40	POA
3" x 3" x 1 1/2"	42130154AD40	42130154A40	\$2,486.00	42130156AD40	42130156A40	\$3,107.50
3" x 3" x 2"	42130204AD40	42130204A40	\$2,661.00	42130206AD40	42130206A40	\$3,169.00
3" x 3" x 2 1/2"	42130254AD40	42130254A40	\$2,872.50	42130256AD40	42130256A40	\$3,590.50
4" x 4" x 2"	42140204AD40	42140204A40	\$3,016.50	42140206AD40	42140206A40	\$3,770.50
4" x 4" x 2 1/2"	42140254AD40	42140254A40	\$3,227.00	42140256AD40	42140256A40	\$4,034.00
4" x 4" x 3"	42140304AD40	42140304A40	\$3,540.00	42140306AD40	42140306A40	\$4,425.00
6" x 6" x 1 1/2"	42160154AD40	42160154A40	POA	42160156AD40	42160156A40	POA
6" x 6" x 2"	42160204AD40	42160204A40	\$4,114.50	42160206AD40	42160206A40	POA
6" x 6" x 3"	42160304AD40	42160304A40	\$4,114.50	42160306AD40	42160306A40	\$5,143.00
6" x 6" x 4"	42160404AD40	42160404A40	\$4,244.50	42160406AD40	42160406A40	\$5,305.50
8" x 8" x 4"	42180404AD40	42180404A40	\$5,968.00	42180406AD40	42180406A40	\$7,459.50
8" x 8" x 6"	42180604AD40	42180604A40	\$8,034.00	42180606AD40	42180606A40	\$10,042.50
10" x 10" x 6"	42110604AD40	42110604A40	\$10,192.00	42110606AD40	42110606A40	\$12,740.50
10" x 10" x 8"	42110804AD40	42110804A40	\$10,281.00	42110806AD40	42110806A40	\$12,851.50
12" x 12" x 8"	42112804AD40	42112804A40	\$14,384.50	42112806AD40	42112806A40	\$17,980.50
12" x 12" x 10"	42112104AD40	42112104A40	\$17,191.50	42112106AD40	42112106A40	\$21,489.00

 Orders for items in shaded areas *cannot* be cancelled or returned.

**Technical Data Sheet: G570**

 For domestically-made fittings, contact your local Tyco Mechanical Products sales representative.  
 See latest catalog or technical data sheets for specific approvals, listings, and design parameters.  
 POA = Price on availability. Prices subject to change without notice.



# Tyco Mechanical Products

## Section 8 – Stainless Steel Systems



### #450 Concentric Reducer, 304 SS & 316 SS, Schedule 40

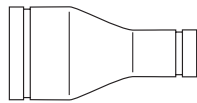

Nominal Size	304 SS			316 SS		
	Domestic	Global	List Price	Domestic	Global	List Price
1½" x 1"	45015014AD40	45015014A40	POA	45015016AD40	45015016A40	POA
1½" x 1¼"	45015134AD40	45015134A40	POA	45015136AD40	45015136A40	POA
2" x 1"	45020104AD40	45020104A40	\$703.00	45020106AD40	45020106A40	POA
2" x 1¼"	45020134AD40	45020134A40	POA	45020136AD40	45020136A40	POA
2" x 1½"	45020154AD40	45020154A40	\$703.00	45020156AD40	45020156A40	\$879.00
2½" x 1½"	45025154AD40	45025154A40	POA	45025156AD40	45025156A40	POA
2½" x 2"	45025204AD40	45025204A40	\$880.00	45025206AD40	45025206A40	\$1,100.00
3" x 1"	45030014AD40	45030014A40	POA	45030016AD40	45030016A40	POA
3" x 1¼"	45030134AD40	45030134A40	POA	45030136AD40	45030136A40	POA
3" x 1½"	45030154AD40	45030154A40	POA	45030156AD40	45030156A40	POA
3" x 2"	45030204AD40	45030204A40	\$956.50	45030206AD40	45030206A40	\$1,195.50
3" x 2½"	45030254AD40	45030254A40	\$956.50	45030256AD40	45030256A40	\$1,195.50
4" x 2"	45040204AD40	45040204A40	POA	45040206AD40	45040206A40	POA
4" x 2½"	45040254AD40	45040254A40	\$1,400.50	45040256AD40	45040256A40	\$1,751.00
4" x 3"	45040304AD40	45040304A40	\$968.50	45040306AD40	45040306A40	\$1,210.50
5" x 3"	45050304AD40	45050304A40	POA	45050306AD40	45050306A40	POA
5" x 4"	45050404AD40	45050404A40	POA	45050406AD40	45050406A40	POA
6" x 2"	45060204AD40	45060204A40	POA	45060206AD40	45060206A40	POA
6" x 2½"	45060254AD40	45060254A40	POA	45060256AD40	45060256A40	POA
6" x 3"	45060304AD40	45060304A40	\$1,400.50	45060306AD40	45060306A40	\$1,751.00
6" x 4"	45060404AD40	45060404A40	\$1,800.00	45060406AD40	45060406A40	\$2,250.00
6" x 5"	45060504AD40	45060504A40	POA	45060506AD40	45060506A40	POA
8" x 3"	45080304AD40	45080304A40	POA	45080306AD40	45080306A40	POA
8" x 4"	45080404AD40	45080404A40	\$2,262.50	45080406AD40	45080406A40	\$2,828.00
8" x 6"	45080604AD40	45080604A40	\$2,685.00	45080606AD40	45080606A40	\$3,356.50
10" x 4"	45010404AD40	45010404A40	POA	45010406AD40	45010406A40	POA
10" x 6"	45010604AD40	45010604A40	\$3,937.50	45010606AD40	45010606A40	\$4,954.00
10" x 8"	45010804AD40	45010804A40	\$4,520.00	45010806AD40	45010806A40	\$5,651.00
12" x 6"	45012604AD40	45012604A40	POA	45012606AD40	45012606A40	POA
12" x 8"	45012804AD40	45012804A40	\$6,547.00	45012806AD40	45012806A40	\$8,183.50
12" x 10"	45012104AD40	45012104A40	\$6,931.50	45012106AD40	45012106A40	\$8,664.00

Orders for items in shaded areas **cannot** be cancelled or returned.

#### Technical Data Sheet: G570

Introduction  
Couplings & Fittings  
Mechanical Tees  
Valves  
Circuit Balancing Valves  
Accessories  
Copper Systems  
Stainless Steel Systems  
Plain End Systems  
Stainless Steel G-PRESS  
HDPE Systems  
Gaskets & Spare Parts  
Preparation Equipment  
Miscellaneous  
Indices

**#451 Eccentric Reducer,  
 304 SS & 316 SS, Schedule 40**

Nominal Size	304 SS			316 SS		
	Domestic	Global	List Price	Domestic	Global	List Price
1 1/4" x 1"	45113014AD40	45113014A40	POA	45113016AD40	45113016A40	POA
1 1/2" x 1"	45115014AD40	45115014A40	POA	45115016AD40	45115016A40	POA
1 1/2" x 1 1/4"	45115134AD40	45115134A40	POA	45115136AD40	45115136A40	POA
2" x 1"	45120014AD40	45120014A40	POA	45120016AD40	45120016A40	POA
2" x 1 1/4"	45120134AD40	45120134A40	POA	45120136AD40	45120136A40	POA
2" x 1 1/2"	45120154AD40	45120154A40	\$2,017.50	45120156AD40	45120156A40	\$2,521.50
2 1/2" x 2"	45125204AD40	45125204A40	\$3,410.50	45125206AD40	45125206A40	\$4,263.00
3" x 1"	45130014AD40	45130014A40	POA	45130016AD40	45130016A40	POA
3" x 2"	45130204AD40	45130204A40	\$3,327.50	45130206AD40	45130206A40	\$4,159.00
3" x 2 1/2"	45130254AD40	45130254A40	\$3,443.50	45130256AD40	45130256A40	\$4,304.50
4" x 2"	45140204AD40	45140204A40	POA	45140206AD40	45140206A40	POA
4" x 2 1/2"	45140254AD40	45140254A40	\$4,714.00	45140256AD40	45140256A40	\$5,892.50
4" x 3"	45140304AD40	45140304A40	\$5,992.00	45140306AD40	45140306A40	\$7,490.00
5" x 3"	45150304AD40	45150304A40	POA	45150306AD40	45150306A40	POA
5" x 4"	45150404AD40	45150404A40	POA	45150406AD40	45150406A40	POA
6" x 2"	45160204AD40	45160204A40	POA	45160206AD40	45160206A40	POA
6" x 2 1/2"	45160254AD40	45160254A40	POA	45160256AD40	45160256A40	POA
6" x 3"	45160304AD40	45160304A40	\$6,632.00	45160306AD40	45160306A40	\$8,290.00
6" x 4"	45160404AD40	45160404A40	\$6,862.00	45160406AD40	45160406A40	\$8,578.00
8" x 3"	45180304AD40	45180304A40	POA	45180306AD40	45180306A40	POA
8" x 4"	45180404AD40	45180404A40	\$9,487.50	45180406AD40	45180406A40	\$11,859.00
8" x 6"	45180604AD40	45180604A40	\$11,565.00	45180606AD40	45180606A40	\$14,456.50
10" x 6"	45110604AD40	45110604A40	\$10,884.50	45110606AD40	45110606A40	\$13,605.50
10" x 8"	45110804AD40	45110804A40	\$11,709.00	45110806AD40	45110806A40	\$14,636.00
12" x 6"	45112604AD40	45112604A40	POA	45112606AD40	45112606A40	POA
12" x 8"	45112804AD40	45112804A40	\$12,536.50	45112806AD40	45112806A40	\$15,670.50
12" x 10"	45112104AD40	45112104A40	\$13,377.50	45112106AD40	45112106A40	\$16,722.50

 Orders for items in shaded areas *cannot* be cancelled or returned.

**Technical Data Sheet: G570**

**#B480 Stainless Steel Grooved Butterfly Valve  
 EPDM or Nitrile, Lever Operator**

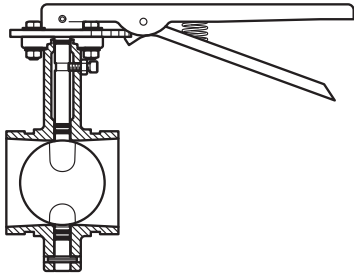

Size	EPDM		Nitrile	
	Part #	List Price	Part #	List Price
2"	B48020EL	\$1,878.50	B48020TL	\$1,878.50
2½"	B48025EL	\$2,151.00	B48025TL	\$2,151.00
76.1mm	B480761EL	\$2,151.00	B480761TL	\$2,151.00
3"	B48030EL	\$2,442.50	B48030TL	\$2,442.50
4"	B48040EL	\$2,762.50	B48040TL	\$2,762.50
165.1mm	B4801651EL	\$4,192.50	B4801651TL	\$4,192.50
6"	B48060EL	\$4,192.50	B48060TL	\$4,192.50

Orders for items in shaded areas **cannot** be cancelled or returned.

**Technical Data Sheet: G340**

**BV435 Stainless Steel Grooved Ball Valve (600 psi)**

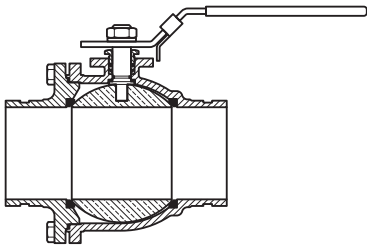

Size	Part Number	List Price
1½"	BV43515	\$899.00
2"	BV43520	\$1,259.50
2½"	BV43525	\$1,654.00
3"	BV43530	\$2,342.50
4"	BV43540	\$2,984.00

**Technical Data Sheet: G370**

Introduction  
 Couplings & Fittings  
 Mechanical Tees  
 Valves  
 Circuit Balancing Valves  
 Accessories  
 Copper Systems  
 Stainless Steel Systems  
 Plain End Systems  
 Stainless Steel G-PRESS  
 HDPE Systems  
 Gaskets & Spare Parts  
 Preparation Equipment  
 Miscellaneous  
 Indices

**#909 Plain End Coupling**  
**with Grade “E” EPDM Gasket or Grade “T” Nitrile Gasket**

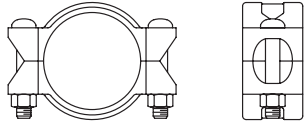
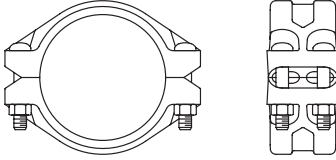
	Nominal Size	Painted			Galvanized		
		Grade “E” EPDM Part No.	Grade “T” Nitrile Part No.	List Price	Grade “E” EPDM Part No.	Grade “T” Nitrile Part No.	List Price
 Fig. 909 – 2" thru 6"	2"	90920ES	90920TS	\$180.00	90920EGS	90920TGS	\$232.50
	2½"	90925ES	90925TS	\$180.00	90925EGS	90925TGS	\$232.50
	3"	90930ES	90930TS	\$263.00	90930EGS	90930TGS	\$343.50
	4"	90940ES	90940TS	\$303.50	90940EGS	90940TGS	\$403.00
	5" *	79008	79008T	\$432.00	79008G	79008GT	\$574.00
 Fig. 909 – 8" thru 18"	6"	90960ES	90960TS	\$527.00	90960EGS	90960TGS	\$715.00
	8"	90980ES	90980TS	\$929.50	90980EGS	90980TGS	\$1,243.50
	10"	90910ES	90910TS	\$1,206.50	90910EGS	90910TGS	\$1,620.00
	12" *	79009	79009T	\$1,514.50	79009G	79009GT	\$2,088.50
	14" *	79010	79010T	\$2,079.00	79010G	79010GT	\$2,698.50
	16" *	79011	79011T	\$2,844.00	79011G	79011GT	\$3,630.00
	18"	90918ES	90918TS	\$3,794.00	90918EGS	90918TGS	\$4,924.00

\* Shurjoint brand model 79.

 Orders for items in shaded areas **cannot** be cancelled or returned.

**Technical Data Sheet: G190**

# Tyco Mechanical Products

## Section 9 – Plain End Systems

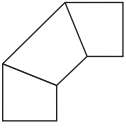

### #910 Plain End 90° Elbow

	Nominal Size	Painted		Galvanized	
		Part Number	List Price	Part Number	List Price
		2"	91020F	\$525.00	91020GF
2½"	91025F	\$614.00	91025GF	\$682.50	
3"	91030F	\$637.50	91030GF	\$713.00	
4"	91040F	\$722.00	91040GF	\$794.00	
6"	91060F	\$1,048.50	91060GF	\$1,276.00	
8"	91080F	\$1,969.00	91080GF	\$2,226.00	
10"	91010F	\$2,507.00	91010GF	\$2,806.00	
12"	91012F	\$2,789.50	91012GF	\$4,292.00	

Orders for items in shaded areas **cannot** be cancelled or returned.

Technical Data Sheet: G192

### #910LR Plain End Long Radius 90° Elbow

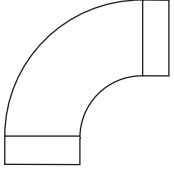
	Nominal Size	Painted		Galvanized	
		Part Number	List Price	Part Number	List Price
		2"	91020LF	POA	91020LGF
2½"	91025LF	POA	91025LGF	POA	
3"	91030LF	POA	91030LGF	POA	
4"	91040LF	POA	91040LGF	POA	
6"	91060LF	POA	91060LGF	POA	
8"	91080LF	POA	91080LGF	POA	

Orders for items in shaded areas **cannot** be cancelled or returned.

Technical Data Sheet: G192

### #901 Plain End 45° Elbow

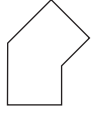
	Nominal Size	Painted		Galvanized	
		Part Number	List Price	Part Number	List Price
		2"	90120F	\$556.50	90120GF
2½"	90125F	\$556.50	90125GF	\$684.00	
3"	90130F	\$637.50	90130GF	\$718.00	
4"	90140F	\$664.50	90140GF	\$735.50	
6"	90160F	\$950.50	90160GF	\$1,116.00	
8"	90180F	\$1,114.50	90180GF	\$1,573.50	
10"	90110F	\$1,151.00	90110GF	\$1,438.50	
12"	90112F	\$2,080.50	90112GF	\$2,450.00	

Orders for items in shaded areas **cannot** be cancelled or returned.

Technical Data Sheet: G192

Introduction  
Couplings & Fittings  
Mechanical Tees  
Valves  
Circuit Balancing Valves  
Accessories  
Copper Systems  
Stainless Steel Systems  
Plain End Systems  
Stainless Steel G-PRESS  
HDPE Systems  
Gaskets & Spare Parts  
Preparation Equipment  
Miscellaneous  
Indices

**#901LR Plain End Long Radius 45° Elbow**

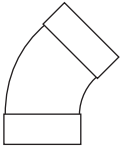
	Nominal Size	Painted		Galvanized	
		Part Number	List Price	Part Number	List Price
	2"	90120LF	POA	90120LGF	POA
2½"	90125LF	POA	90125LGF	POA	
3"	90130LF	POA	90130LGF	POA	
4"	90140LF	POA	90140LGF	POA	
6"	90160LF	POA	90160LGF	POA	
8"	90180LF	POA	90180LGF	POA	

 Orders for items in shaded areas *cannot* be cancelled or returned.

**Technical Data Sheet: G192**
**#919 Plain End Tee**

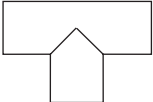
	Nominal Size	Painted		Galvanized	
		Part Number	List Price	Part Number	List Price
	2"	91920F	\$428.50	91920GF	\$480.50
2½"	91925F	\$558.50	91925GF	\$632.50	
3"	91930F	\$858.00	91930GF	\$979.50	
4"	91940F	\$1,228.50	91940GF	\$1,535.50	
6"	91960F	\$1,462.00	91960GF	\$1,678.00	
8"	91980F	\$2,107.00	91980GF	POA	
10"	91910F	POA	91910GF	POA	
12"	91912F	\$3,861.00	91912GF	POA	

 Orders for items in shaded areas *cannot* be cancelled or returned.

**Technical Data Sheet: G192**
**#927 Plain End Cross**

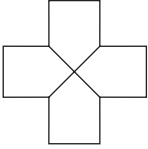
	Nominal Size	Painted		Galvanized	
		Part Number	List Price	Part Number	List Price
	2"	92720F	\$580.50	92720GF	POA
2½"	92725F	POA	92725GF	POA	
3"	92730F	POA	92730GF	POA	
4"	92740F	POA	92740GF	POA	
6"	92760F	POA	92760GF	POA	
8"	92780F	POA	92780GF	POA	
10"	92710F	POA	92710GF	POA	
12"	92712F	POA	92712GF	POA	

 Orders for items in shaded areas *cannot* be cancelled or returned.

**Technical Data Sheet: G192**

## Tyco Mechanical Products Section 9 – Plain End Systems

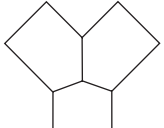

### #924 Plain End True Wye

	<i>Nominal Size</i>	<i>Painted</i>		<i>Galvanized</i>	
		<i>Part Number</i>	<i>List Price</i>	<i>Part Number</i>	<i>List Price</i>
		2"	92420F	POA	92420GF
2½"	92425F	POA	92425GF	POA	
3"	92430F	POA	92430GF	POA	
4"	92440F	POA	92440GF	POA	
6"	92460F	POA	92460GF	POA	
8"	92480F	POA	92480GF	POA	
10"	92410F	POA	92410GF	POA	
12"	92412F	POA	92412GF	POA	

Orders for items in shaded areas **cannot** be cancelled or returned.

**Technical Data Sheet: G192**

### #960 Plain End Cap (Bull Plug)

	<i>Nominal Size</i>	<i>Painted</i>		<i>Galvanized</i>	
		<i>Part Number</i>	<i>List Price</i>	<i>Part Number</i>	<i>List Price</i>
		2"	96020F	\$300.00	96020GF
2½"	96025F	\$300.00	96025GF	POA	
3"	96030F	\$438.00	96030GF	POA	
4"	96040F	\$564.50	96040GF	POA	
6"	96060F	\$1,323.50	96060GF	POA	
8"	96080F	\$2,485.00	96080GF	POA	
10"	96010F	POA	96010GF	POA	
12"	96012F	\$6,670.50	96012GF	POA	

Orders for items in shaded areas **cannot** be cancelled or returned.

**Technical Data Sheet: G192**

### #914 Plain End Lateral

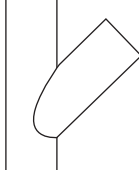
	<i>Nominal Size</i>	<i>Painted</i>		<i>Galvanized</i>	
		<i>Part Number</i>	<i>List Price</i>	<i>Part Number</i>	<i>List Price</i>
		2"	91420F	\$578.50	91420GF
2½"	91425F	\$665.50	91425GF	\$783.00	
3"	91430F	\$790.00	91430GF	\$928.50	
4"	91440F	\$1,088.00	91440GF	\$1,218.00	
6"	91460F	\$1,903.50	91460GF	\$2,309.50	
8"	91480F	\$3,193.50	91480GF	\$3,760.00	
10"	91410F	\$3,193.00	91410GF	\$5,585.00	
12"	91412F	\$5,870.00	91412GF	\$7,549.00	

Orders for items in shaded areas **cannot** be cancelled or returned.

**Technical Data Sheet: G192**

Introduction  
Couplings & Fittings  
Mechanical Tees  
Valves  
Circuit Balancing Valves  
Accessories  
Copper Systems  
Stainless Steel Systems  
Plain End Systems  
Stainless Steel G-PRESS  
HDPE Systems  
Gaskets & Spare Parts  
Preparation Equipment  
Miscellaneous  
Indices

**#999 Plain End Swaged Nipple**

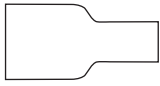
	Nominal Size	Painted		Galvanized	
		Part Number	List Price	Part Number	List Price
	2 1/2" x 2"	9992520F	POA	9992520GF	POA
	3" x 2"	9993020F	POA	9993020GF	POA
	3" x 2 1/2"	9993025F	POA	9993025GF	POA
	4" x 2"	9994020F	POA	9994020GF	POA
	4" x 2 1/2"	9994025F	POA	9994025GF	POA
	4" x 3"	9994030F	POA	9994030GF	POA
	5" x 2"	9995020F	POA	9995020GF	POA
	5" x 3"	9995030F	POA	9995030GF	POA
	5" x 4"	9995040F	POA	9995040GF	POA
	6" x 2"	9996020F	POA	9996020GF	POA
	6" x 2 1/2"	9996025F	POA	9996025GF	POA
	6" x 3"	9996030F	POA	9996030GF	POA
	6" x 4"	9996040F	POA	9996040GF	POA
	6" x 5"	9996050F	POA	9996050GF	POA
	8" x 3"	9998030F	POA	9998030GF	POA
	8" x 4"	9998040F	POA	9998040GF	POA
8" x 5"	9998050F	POA	9998050GF	POA	
8" x 6"	9998060F	POA	9998060GF	POA	

 Orders for items in shaded areas **cannot** be cancelled or returned.

**Technical Data Sheet: G192**
**#991 Adapter Nipple – Plain x Thread**

	Nominal Size	Painted		Galvanized	
		Part Number	List Price	Part Number	List Price
	2"	99120F	\$51.50	99120GF	POA
	2 1/2"	99125F	\$59.50	99125GF	POA
	3"	99130F	\$72.50	99130GF	POA
	4"	99140F	\$118.00	99140GF	POA
	6"	99160F	\$311.50	99160GF	POA
	8"	99180F	POA	99180GF	POA

 Orders for items in shaded areas **cannot** be cancelled or returned.

**Technical Data Sheet: G192**



# Tyco Mechanical Products

## Section 9 – Plain End Systems



<b>#992 Adapter Nipple – Plain x Grooved</b>					
	<b>Nominal Size</b>	<b>Painted</b>		<b>Galvanized</b>	
		<b>Part Number</b>	<b>List Price</b>	<b>Part Number</b>	<b>List Price</b>
	2"	<b>99220F</b>	\$51.50	<b>99220GF</b>	POA
2½"	<b>99225F</b>	\$59.50	<b>99225GF</b>	POA	
3"	<b>99230F</b>	\$72.50	<b>99230GF</b>	POA	
4"	<b>99240F</b>	\$118.00	<b>99240GF</b>	POA	
6"	<b>99260F</b>	\$311.50	<b>99260GF</b>	POA	
8"	<b>99280F</b>	POA	<b>99280GF</b>	POA	

Orders for items in shaded areas **cannot** be cancelled or returned.

**Technical Data Sheet: G192**

<b>#993 Adapter Nipple – Plain x Bevel</b>					
	<b>Nominal Size</b>	<b>Painted</b>		<b>Galvanized</b>	
		<b>Part Number</b>	<b>List Price</b>	<b>Part Number</b>	<b>List Price</b>
	2"	<b>99320F</b>	\$51.50	<b>99320GF</b>	POA
2½"	<b>99325F</b>	\$59.50	<b>99325GF</b>	POA	
3"	<b>99330F</b>	\$72.50	<b>99330GF</b>	POA	
4"	<b>99340F</b>	\$118.00	<b>99340GF</b>	POA	
6"	<b>99360F</b>	\$311.50	<b>99360GF</b>	POA	
8"	<b>99380F</b>	POA	<b>99380GF</b>	POA	

Orders for items in shaded areas **cannot** be cancelled or returned.

**Technical Data Sheet: G192**

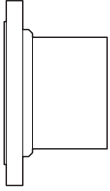
<b>#941 Flange Adapter 150 lbs.</b>					
	<b>Nominal Size</b>	<b>Painted</b>		<b>Galvanized</b>	
		<b>Part Number</b>	<b>List Price</b>	<b>Part Number</b>	<b>List Price</b>
	2"	<b>94120F</b>	POA	<b>94120GF</b>	POA
2½"	<b>94125F</b>	POA	<b>94125GF</b>	POA	
3"	<b>94130F</b>	POA	<b>94130GF</b>	POA	
4"	<b>94140F</b>	POA	<b>94140GF</b>	POA	
6"	<b>94160F</b>	POA	<b>94160GF</b>	POA	
8"	<b>94180F</b>	POA	<b>94180GF</b>	POA	

Orders for items in shaded areas **cannot** be cancelled or returned.

Raised face flanges are standard; flat flanges are quoted on application.

**Technical Data Sheet: G192**

Introduction  
Couplings & Fittings  
Mechanical Tees  
Valves  
Circuit Balancing Valves  
Accessories  
Copper Systems  
Stainless Steel Systems  
Plain End Systems  
Stainless Steel G-PRESS  
HDPE Systems  
Gaskets & Spare Parts  
Preparation Equipment  
Miscellaneous  
Indices

**#942 Flange Adapter 300 lbs.**

	Nominal Size	Painted		Galvanized	
		Part Number	List Price	Part Number	List Price
	2"	94220F	POA	94220GF	POA
2½"	94225F	POA	94225GF	POA	
3"	94230F	POA	94230GF	POA	
4"	94240F	POA	94240GF	POA	
6"	94260F	POA	94260GF	POA	
8"	94280F	POA	94280GF	POA	

 Orders for items in shaded areas *cannot* be cancelled or returned.

Raised face flanges are standard; flat flanges are quoted on application.

**Technical Data Sheet: G192**
**#921 Reducing Tee Plain End**

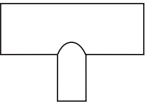
	Nominal Size	Painted		Galvanized	
		Part Number	List Price	Part Number	List Price
	3" x 3" x 2"	9213020F	POA	9213020GF	\$853.00
4" x 4" x 2"	9214020F	\$531.00	9214020GF	POA	
4" x 4" x 2½"	9214025F	\$546.00	9214025GF	POA	
4" x 4" x 3"	9214030F	\$546.00	9214030GF	POA	
6" x 6" x 2"	9216020F	POA	9216020GF	POA	
6" x 6" x 3"	9216030F	\$929.50	9216030GF	POA	
6" x 6" x 4"	9216040F	POA	9216040GF	\$1,196.00	
8" x 8" x 2"	9218020F	POA	9218020GF	\$3,245.00	
8" x 8" x 3"	9218030F	POA	9218030GF	POA	
8" x 8" x 4"	9218040F	\$1,056.00	9218040GF	POA	
8" x 8" x 6"	9218060F	\$1,238.00	9218060GF	POA	
10" x 10" x 4"	9211040F	POA	9211040GF	POA	
10" x 10" x 6"	9211060F	POA	9211060GF	POA	
10" x 10" x 8"	9211080F	POA	9211080GF	POA	

 Orders for items in shaded areas *cannot* be cancelled or returned.

**Technical Data Sheet: G192**

## Tyco Mechanical Products Section 10 – SS G-PRESS Systems



### #407 G-PRESS 316 Stainless Steel Coupling (Press x Press)

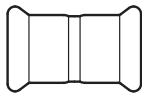

Nominal Size	Grade "E" EPDM O-Ring Part Number	Grade "T" Nitrile O-Ring Part Number	List Price	Grade "O" Fluoroelastomer O-Ring Part Number	List Price	Pieces/ Bag Quantities
1/2"	407050E	407050T	\$48.00	407050O	\$65.50	20
3/4"	407075E	407075T	\$53.00	407075O	\$73.50	20
1"	407100E	407100T	\$60.00	407100O	\$79.00	10
1 1/2"	407150E	407150T	\$80.50	407150O	\$136.50	4
2"	407200E	407200T	\$106.00	407200O	\$179.50	4

Orders for items in shaded areas *cannot* be cancelled or returned.

**Technical Data Sheet: G550**

### #408 G-PRESS 316 Stainless Steel Slip Coupling (Press x Press)

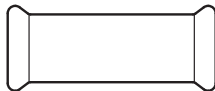

Nominal Size	Grade "E" EPDM O-Ring Part Number	Grade "T" Nitrile O-Ring Part Number	List Price	Grade "O" Fluoroelastomer O-Ring Part Number	List Price	Pieces/ Bag Quantities
1/2"	408050E	408050T	\$63.00	408050O	\$80.50	20
3/4"	408075E	408075T	\$68.50	408075O	\$89.50	20
1"	408100E	408100T	\$78.50	408100O	\$105.00	10
1 1/2"	408150E	408150T	\$101.00	408150O	\$178.50	4
2"	408200E	408200T	\$129.50	408200O	\$228.00	4

Orders for items in shaded areas *cannot* be cancelled or returned.

**Technical Data Sheet: G550**

### #468 G-PRESS 316 Stainless Steel 90° Elbow (Press x Press)

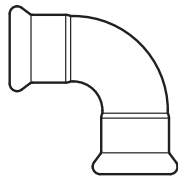

Nominal Size	Grade "E" EPDM O-Ring Part Number	Grade "T" Nitrile O-Ring Part Number	List Price	Grade "O" Fluoroelastomer O-Ring Part Number	List Price	Pieces/ Bag Quantities
1/2"	468050E	468050T	\$90.00	468050O	\$107.50	20
3/4"	468075E	468075T	\$101.00	468075O	\$122.50	10
1"	468100E	468100T	\$120.00	468100O	\$146.50	10
1 1/2"	468150E	468150T	\$237.50	468150O	\$314.50	2
2"	468200E	468200T	\$303.50	468200O	\$402.50	2

Orders for items in shaded areas *cannot* be cancelled or returned.

**Technical Data Sheet: G550**

Introduction  
Couplings & Fittings  
Mechanical Tees  
Valves  
Circuit Balancing Valves  
Accessories  
Copper Systems  
Stainless Steel Systems  
Plain End Systems  
Stainless Steel G-PRESS  
HDPE Systems  
Gaskets & Spare Parts  
Preparation Equipment  
Miscellaneous  
Indices

**#467 G-PRESS 316 Stainless Steel 90° Elbow (Press x Fitting)**

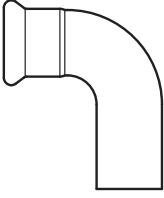
	Nominal Size	Grade "E" EPDM O-Ring Part Number	Grade "T" Nitrile O-Ring Part Number	List Price	Grade "O" Fluoroelastomer O-Ring Part Number	List Price	Pieces/Bag Quantities
	1/2"	467050E	467050T	\$90.00	4670500	\$98.50	20
	3/4"	467075E	467075T	\$101.00	4670750	\$112.00	10
	1"	467100E	467100T	\$120.00	4671000	\$133.00	10
	1 1/2"	467150E	467150T	\$237.50	4671500	\$276.00	2
	2"	467200E	467200T	\$303.50	4672000	\$352.50	2

 Orders for items in shaded areas *cannot* be cancelled or returned.

**Technical Data Sheet: G550**
**#471 G-PRESS 316 Stainless Steel 45° Elbow (Press x Press)**

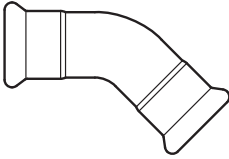
	Nominal Size	Grade "E" EPDM O-Ring Part Number	Grade "T" Nitrile O-Ring Part Number	List Price	Grade "O" Fluoroelastomer O-Ring Part Number	List Price	Pieces/Bag Quantities
	1/2"	471050E	471050T	\$80.00	4710500	\$97.50	10
	3/4"	471075E	471075T	\$88.50	4710750	\$109.00	10
	1"	471100E	471100T	\$105.50	4711000	\$131.50	10
	1 1/2"	471150E	471150T	\$207.00	4711500	\$283.50	2
	2"	471200E	471200T	\$265.00	4712000	\$364.00	2

 Orders for items in shaded areas *cannot* be cancelled or returned.

**Technical Data Sheet: G550**
**#470 G-PRESS 316 Stainless Steel 45° Elbow (Press x Fitting)**

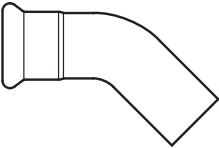
	Nominal Size	Grade "E" EPDM O-Ring Part Number	Grade "T" Nitrile O-Ring Part Number	List Price	Grade "O" Fluoroelastomer O-Ring Part Number	List Price	Pieces/Bag Quantities
	1/2"	470050E	470050T	\$80.00	4700500	\$89.00	20
	3/4"	470075E	470075T	\$88.50	4700750	\$98.50	10
	1"	470100E	470100T	\$105.50	4701000	\$118.00	10
	1 1/2"	470150E	470150T	\$207.00	4701500	\$245.00	2
	2"	470200E	470200T	\$265.00	4702000	\$314.50	2

 Orders for items in shaded areas *cannot* be cancelled or returned.

**Technical Data Sheet: G550**

## Tyco Mechanical Products Section 10 – SS G-PRESS Systems

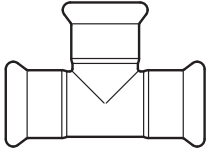

### #442 G-PRESS 316 Stainless Steel Equal Tee (Press x Press x Press)

	Nominal Size	Grade "E" EPDM O-Ring Part Number	Grade "T" Nitrile O-Ring Part Number	List Price	Grade "O" Fluoroelastomer O-Ring Part Number	List Price	Pieces/ Bag Quantities
	1/2"	442050E	442050T	\$163.50	442050O	\$190.00	20
	3/4"	442075E	442075T	\$180.50	442075O	\$212.00	10
	1"	442100E	442100T	\$193.00	442100O	\$232.50	10
	1 1/2"	442150E	442150T	\$247.00	442150O	\$362.00	2
	2"	442200E	442200T	\$307.50	442200O	\$455.50	2

Orders for items in shaded areas *cannot* be cancelled or returned.

**Technical Data Sheet: G550**

### #473 G-PRESS 316 Stainless Steel Reducing Tee (Press x Press x Press)

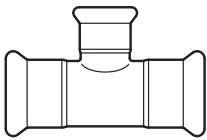
	Nominal Size	Grade "E" EPDM O-Ring Part Number	Grade "T" Nitrile O-Ring Part Number	List Price	Grade "O" Fluoroelastomer O-Ring Part Number	List Price	Pieces/ Bag Quantities
	3/4" x 3/4" x 1/2"	4737505E	4737505T	\$182.00	4737505O	\$212.00	10
	1" x 1" x 1/2"	4731005E	4731005T	\$188.00	4731005O	\$223.00	10
	1" x 1" x 3/4"	4731075E	4731075T	\$192.00	4731075O	\$229.00	10
	1 1/2" x 1 1/2" x 1/2"	4731505E	4731505T	\$226.50	4731505O	\$312.00	2
	1 1/2" x 1 1/2" x 3/4"	4731575E	4731575T	\$229.00	4731575O	\$316.00	2
	1 1/2" x 1 1/2" x 1"	4731510E	4731510T	\$230.00	4731510O	\$319.50	2
	2" x 2" x 1/2"	4732005E	4732005T	\$295.00	4732005O	\$402.50	2
	2" x 2" x 3/4"	4732075E	4732075T	\$299.50	4732075O	\$408.50	2
	2" x 2" x 1"	4732010E	4732010T	\$308.00	4732010O	\$420.00	2
	2" x 2" x 1 1/2"	4732015E	4732015T	\$339.50	4732015O	\$476.50	2

Orders for items in shaded areas *cannot* be cancelled or returned.

**Technical Data Sheet: G550**

Introduction  
Couplings & Fittings  
Mechanical Tees  
Valves  
Circuit Balancing Valves  
Accessories  
Copper Systems  
Stainless Steel Systems  
Plain End Systems  
Stainless Steel G-PRESS  
HDPE Systems  
Gaskets & Spare Parts  
Preparation Equipment  
Miscellaneous  
Indices

**#478 G-PRESS 316 Stainless Steel Reducing Tee Adapter (Press x Press x Female NPT)**

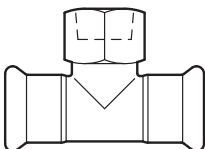
	Nominal Size	Grade "E"	Grade "T"	List Price	Grade "O"	List Price	Pieces/Bag Quantities
		EPDM O-Ring Part Number	Nitrile O-Ring Part Number		Fluoroelastomer O-Ring Part Number		
	1/2" x 1/2" x 1/2"	4780505E	4780505T	\$247.00	4780505O	\$264.50	20
	1/2" x 1/2" x 3/4"	4780575E	4780575T	\$296.50	4780575O	\$315.00	20
	3/4" x 3/4" x 1/2"	4787505E	4787505T	\$267.00	4787505O	\$288.00	10
	3/4" x 3/4" x 3/4"	4787575E	4787575T	\$270.00	4787575O	\$291.00	10
	3/4" x 3/4" x 1"	4787510E	4787510T	\$319.50	4787510O	\$342.00	10
	1" x 1" x 1/2"	4781015E	4781015T	\$272.00	4781015O	\$298.50	10
	1" x 1" x 3/4"	4781075E	4781075T	\$273.00	4781075O	\$299.50	10
	1" x 1" x 1"	4781010E	4781010T	\$296.50	4781010O	\$322.50	-
	1" x 1" x 1 1/4"	4781012E	4781012T	\$319.50	4781012O	\$349.50	10
	1 1/2" x 1 1/2" x 1/2"	4781505E	4781505T	\$308.00	4781505O	\$385.00	4
	1 1/2" x 1 1/2" x 3/4"	4781575E	4781575T	\$311.50	4781575O	\$388.00	4
	1 1/2" x 1 1/2" x 1"	4781510E	4781510T	\$340.00	4781510O	\$417.00	4
	1 1/2" x 1 1/2" x 1 1/2"	4781515E	4781515T	\$365.50	4781515O	\$414.00	4
	2" x 2" x 1/2"	4782005E	4782005T	\$351.00	4782005O	\$450.00	2
	2" x 2" x 3/4"	4782075E	4782075T	\$354.50	4782075O	\$453.50	2
	2" x 2" x 1"	4782010E	4782010T	\$380.00	4782010O	\$478.50	2
2" x 2" x 2"	4782020E	4782020T	\$507.50	4782020O	\$590.00	2	

 Orders for items in shaded areas **cannot** be cancelled or returned.

**Technical Data Sheet: G550**
**#474 G-PRESS 316 Stainless Steel Reducer (Fitting x Press)**

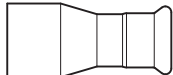
	Nominal Size	Grade "E"	Grade "T"	List Price	Grade "O"	List Price	Pieces/Bag Quantities
		EPDM O-Ring Part Number	Nitrile O-Ring Part Number		Fluoroelastomer O-Ring Part Number		
	3/4" x 1/2"	4747505E	4747505T	\$148.00	4747505O	\$167.00	10
	1" x 1/2"	4741005E	4741005T	\$199.00	4741005O	\$221.00	10
	1" x 3/4"	4741075E	4741075T	\$158.00	4741075O	\$181.50	10
	1 1/2" x 1/2"	4741505E	4741505T	\$279.50	4741505O	\$326.00	4
	1 1/2" x 3/4"	4741575E	4741575T	\$262.00	4741575O	\$311.00	4
	1 1/2" x 1"	4741510E	4741510T	\$146.00	4741510O	\$197.50	4
	2" x 1/2"	4742005E	4742005T	\$518.50	4742005O	\$576.50	2
	2" x 3/4"	4742075E	4742075T	\$233.50	4742075O	\$293.50	2
	2" x 1"	4742010E	4742010T	\$180.50	4742010O	\$243.00	2
	2" x 1 1/2"	4742015E	4742015T	\$180.50	4742015O	\$268.00	2

 Orders for items in shaded areas **cannot** be cancelled or returned.

**Technical Data Sheet: G550**

## Tyco Mechanical Products

### Section 10 – SS G-PRESS Systems

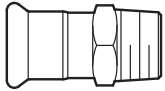

<b>#476 G-PRESS 316 Stainless Steel Adapter (Press x Male NPT)</b>							
	<i>Nominal Size</i>	<i>Grade "E" EPDM O-Ring Part Number</i>	<i>Grade "T" Nitrile O-Ring Part Number</i>	<i>List Price</i>	<i>Grade "O" Fluoroelastomer O-Ring Part Number</i>	<i>List Price</i>	<i>Pieces/Bag Quantities</i>
	1/2" x 1/2"	4760505E	4760505T	\$90.50	4760505O	\$99.50	20
	1/2" x 3/4"	4760575E	4760575T	\$125.50	4760575O	\$136.00	20
	1/2" x 1"	4760510E	4760510T	\$138.50	4760510O	\$150.00	20
	3/4" x 1/2"	4767505E	4767505T	\$94.00	4767505O	\$103.00	–
	3/4" x 3/4"	4767575E	4767575T	\$94.00	4767575O	\$105.00	20
	3/4" x 1"	4767510E	4767510T	\$109.00	4767510O	\$122.50	20
	3/4" x 1 1/4"	4767512E	4767512T	\$138.50	4767512O	\$149.00	20
	1" x 3/4"	4761075E	4761075T	\$111.50	4761075O	\$122.50	–
	1" x 1"	4761010E	4761010T	\$111.50	4761010O	\$125.00	10
	1" x 1 1/4"	4761012E	4761012T	\$138.50	4761012O	\$153.00	10
	1" x 1 1/2"	4761015E	4761015T	\$138.50	4761015O	\$153.00	10
	1 1/2" x 3/4"	4761575E	4761575T	\$208.00	4761575O	\$218.50	–
	1 1/2" x 1"	4761510E	4761510T	POA	4761510O	POA	–
	1 1/2" x 1 1/4"	4761512E	4761512T	\$212.50	4761512O	\$234.00	4
1 1/2" x 1 1/2"	4761515E	4761515T	\$186.00	4761515O	\$247.50	4	
2" x 1 1/2"	4762015E	4762015T	\$309.00	4762015O	\$345.50	4	
2" x 2"	4762020E	4762020T	\$229.50	4762020O	\$280.50	4	

Orders for items in shaded areas *cannot* be cancelled or returned.

Technical Data Sheet: G550

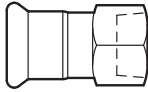
<b>#479 G-PRESS 316 Stainless Steel (Press x Female NPT)</b>							
	<i>Nominal Size</i>	<i>Grade "E" EPDM O-Ring Part Number</i>	<i>Grade "T" Nitrile O-Ring Part Number</i>	<i>List Price</i>	<i>Grade "O" Fluoroelastomer O-Ring Part Number</i>	<i>List Price</i>	<i>Pieces/Bag Quantities</i>
	1/2" x 1/2"	4790505E	4790505T	\$110.00	4790505O	\$118.50	20
	1/2" x 3/4"	4790575E	4790575T	\$158.50	4790575O	\$172.00	20
	1/2" x 1"	4790510E	4790510T	\$213.50	4790510O	\$253.00	20
	3/4" x 1/2"	4797505E	4797505T	\$110.50	4797505O	\$121.50	–
	3/4" x 3/4"	4797575E	4797575T	\$113.00	4797575O	\$124.00	20
	3/4" x 1"	4797510E	4797510T	\$113.00	4797510O	\$122.50	20
	3/4" x 1 1/4"	4797512E	4797512T	\$329.50	4797512O	\$358.00	20
	1" x 1/2"	4791005E	4791005T	\$119.00	4791005O	\$133.00	–
	1" x 3/4"	4791075E	4791075T	\$127.00	4791075O	\$140.50	–
	1" x 1"	4791010E	4791010T	\$135.00	4791010O	\$149.00	10
	1" x 1 1/4"	4791012E	4791012T	\$255.50	4791012O	\$277.50	10
	1" x 1 1/2"	4791015E	4791015T	\$255.50	4791015O	\$277.50	10
	1 1/2" x 1"	4791510E	4791510T	\$213.50	4791510O	\$253.00	–
	1 1/2" x 1 1/4"	4791512E	4791512T	POA	4791512O	POA	–
1 1/2" x 1 1/2"	4791515E	4791515T	\$268.00	4791515O	\$307.50	4	
1 1/2" x 2"	4791520E	4791520T	\$316.50	4791520O	\$347.50	4	
2" x 1 1/4"	4792012E	4792012T	\$313.50	4792012O	POA	–	
2" x 1 1/2"	4792015E	4792015T	\$264.50	4792015O	\$315.50	4	
2" x 2"	4792020E	4792020T	\$291.00	4792020O	\$342.00	4	

Orders for items in shaded areas *cannot* be cancelled or returned.

Technical Data Sheet: G550

**#484 G-PRESS 316 Stainless Steel End Cap (Press)**

	Nominal Size	Grade "E" EPDM O-Ring Part Number	Grade "T" Nitrile O-Ring Part Number	List Price	Grade "O" Fluoroelastomer O-Ring Part Number	List Price	Pieces/Bag Quantities
	1/2"	484050E	484050T	\$112.50	484050O	\$121.00	10
3/4"	484075E	484075T	\$125.00	484075O	\$133.50	10	
1"	484100E	484100T	\$133.00	484100O	\$148.00	10	
1 1/2"	484150E	484150T	\$170.00	484150O	\$249.50	4	
2"	484200E	484200T	\$212.00	484200O	\$290.00	4	

 Orders for items in shaded areas *cannot* be cancelled or returned.

**Technical Data Sheet: G550**
**#461 G-PRESS 316 Stainless Steel Weld Adaptor (Fitting x Weld)**

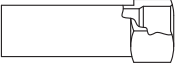
	Nominal Size	Grade "E" EPDM O-Ring Part Number	Grade "T" Nitrile O-Ring Part Number	List Price	Grade "O" Fluoroelastomer O-Ring Part Number	List Price	Pieces/Bag Quantities
	1/2"	461050E	461050T	\$88.00	461050O	\$96.00	–
3/4"	461075E	461075T	\$91.00	461075O	\$100.50	–	
1"	461100E	461100T	\$108.00	461100O	\$120.00	–	
1 1/2"	461150E	461150T	\$188.00	461150O	\$224.50	–	
2"	461200E	461200T	\$222.00	461200O	\$268.50	–	

 Orders for items in shaded areas *cannot* be cancelled or returned.

**Technical Data Sheet: G550**
**#477 G-PRESS 316 Stainless Steel Transition Nipple (Groove x Fitting)**

	Nominal Size	Part Number	List Price	Pieces/Bag Quantities
	3/4"	477075	\$123.00	–
1"	477100	\$126.50	–	
1 1/2"	477150	\$158.50	–	
2"	477200	\$166.50	–	

**Technical Data Sheet: G550**
**#485 G-PRESS 316 Stainless Steel Union (Press x Press)**

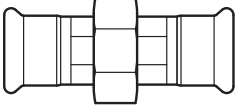
	Nominal Size	Grade "E" EPDM O-Ring Part Number	Grade "T" Nitrile O-Ring Part Number	List Price	Grade "O" Fluoroelastomer O-Ring Part Number	List Price	Pieces/Bag Quantities
	1/2"	485050E	485050T	\$547.50	485050O	\$565.00	10
3/4"	485075E	485075T	\$621.50	485075O	\$642.50	10	
1"	485100E	485100T	\$756.50	485100O	\$782.50	4	
1 1/2"	485150E	485150T	\$1,293.00	485150O	\$1,369.50	2	
2"	485200E	485200T	\$1,594.00	485200O	\$1,693.00	2	

 Orders for items in shaded areas *cannot* be cancelled or returned.

**Technical Data Sheet: G550**



## Tyco Mechanical Products Section 10 – SS G-PRESS Systems

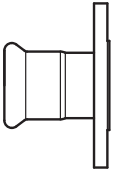

### #475 G-PRESS 316 Stainless Steel Flange Adapter (Press x Flange)

	Nominal Size	Grade "E" EPDM O-Ring Part Number	Grade "T" Nitrile O-Ring Part Number	List Price	Grade "O" Fluoroelastomer O-Ring Part Number	List Price	Pieces/Bag Quantities
	1/2"	475050E	475050T	\$666.50	4750500	\$675.50	1
	3/4"	475075E	475075T	\$686.00	4750750	\$696.50	1
	1"	475100E	475100T	\$696.50	4751000	\$710.00	1
	1 1/2"	475150E	475150T	\$849.00	4751500	\$887.50	1
	2"	475200E	475200T	\$945.00	4752000	\$994.00	1

Orders for items in shaded areas *cannot* be cancelled or returned.

**Technical Data Sheet: G550**

### #466 G-PRESS 316 Stainless Steel Flange Adapter Van Stone (Press x Flange)

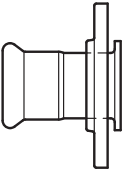
	Nominal Size	Grade "E" EPDM O-Ring Part Number	Grade "T" Nitrile O-Ring Part Number	List Price	Grade "O" Fluoroelastomer O-Ring Part Number	List Price	Pieces/Bag Quantities
	1/2"	466050E	466050T	\$233.00	4660500	\$242.00	1
	3/4"	466075E	466075T	\$233.00	4660750	\$243.50	1
	1"	466100E	466100T	\$314.00	4661000	\$327.00	1
	1 1/2"	466150E	466150T	\$345.50	4661500	\$384.00	1
	2"	466200E	466200T	\$370.50	4662000	\$420.00	1

Orders for items in shaded areas *cannot* be cancelled or returned.

**Technical Data Sheet: G550**

### #469 G-PRESS Stainless Steel Ball Valve (Press x Press)

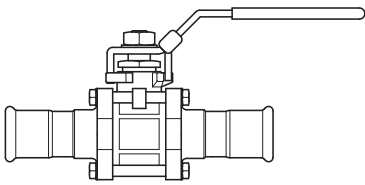
	Nominal Size	Grade "E" EPDM O-Ring Part Number	Grade "T" Nitrile O-Ring Part Number	List Price	Grade "O" Fluoroelastomer O-Ring Part Number	List Price	Pieces/ Bag Quantities
	1/2"	469050E	469050T	\$285.00	4690500	\$302.50	1
	3/4"	469075E	469075T	\$314.00	4690750	\$334.50	1
	1"	469100E	469100T	\$375.50	4691000	\$402.00	1
	1 1/2"	469150E	469150T	\$526.50	4691500	\$603.50	1
	2"	469200E	469200T	\$644.50	4692000	\$743.00	1

Orders for items in shaded areas *cannot* be cancelled or returned.

**Technical Data Sheet: G551**

### G-PRESS Stainless Steel O-Rings

	Nominal Size	Grade "E" EPDM O-Ring Part Number	Grade "T" Nitrile O-Ring Part Number	List Price	Grade "O" Fluoroelastomer O-Ring Part Number	List Price	Pieces/Bag Quantities
	1/2"	05SSPRESSE	05SSPRESST	\$7.50	05SSPRESSO	\$22.50	–
	3/4"	08SSPRESSE	08SSPRESST	\$8.00	08SSPRESSO	\$25.00	–
	1"	10SSPRESSE	10SSPRESST	\$10.00	10SSPRESSO	\$28.50	–
	1 1/2"	15SSPRESSE	15SSPRESST	\$13.50	15SSPRESSO	\$57.50	–
	2"	20SSPRESSE	20SSPRESST	\$18.50	20SSPRESSO	\$76.00	–

Orders for items in shaded areas *cannot* be cancelled or returned.

**Technical Data Sheet: G550**

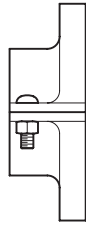
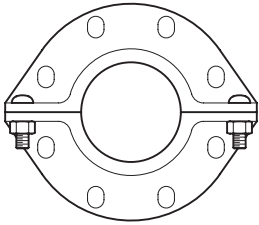
**#9094 HDPE Flange Coupling  
 with Grade “E” EPDM Gasket**

<i>Nominal Size</i>	<i>Part Number</i>	<i>List Price</i>
4"	909440ES	\$694.00
6"	909460ES	\$976.00
8"	909480ES	\$1,142.50

 Orders for items in shaded areas *cannot* be cancelled or returned.

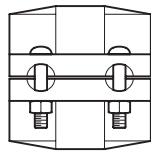
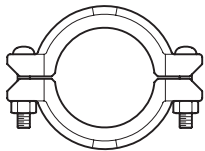
**Technical Data Sheet: G584**
**#9095 HDPE Coupling  
 with Grade “E” EPDM Gasket**

<i>Nominal Size</i>	<i>Part Number</i>	<i>List Price</i>
2"	909520ES	\$454.50
3"	909530ES	\$541.50
4"	909540ES	\$595.00
6"	909560ES	\$827.00
8"	909580ES	\$969.00
10"	909510ES	\$1,114.50
12"	909512ES	\$1,283.50
14"	909514ES	\$3,627.00
16"	909516ES	\$4,839.50
18"	909518ES	\$5,930.00
20"	909521ES	\$8,052.00

 Orders for items in shaded areas *cannot* be cancelled or returned.

**Technical Data Sheet: G580**

**#9097 HDPE Transition Coupling**

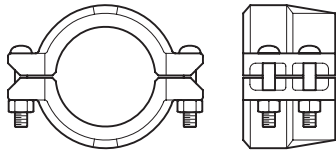



<i>Nominal Size</i>	<i>Part Number</i>	<i>List Price</i>
2"	<b>909720ES</b>	\$489.50
3"	<b>909730ES</b>	\$572.50
4"	<b>909740ES</b>	\$668.50
6"	<b>909760ES</b>	\$918.00
8"	<b>909780ES</b>	\$1,056.50
10"	<b>909710ES</b>	\$1,457.00
12"	<b>909712ES</b>	\$1,666.00

Orders for items in shaded areas **cannot** be cancelled or returned.

**Technical Data Sheet: G582**

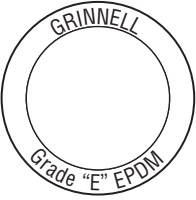
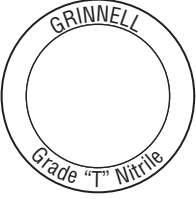

Introduction
Couplings & Fittings
Mechanical Tees
Valves
Circuit Balancing Valves
Accessories
Copper Systems
Stainless Steel Systems
Plain End Systems
Stainless Steel G-PRESS
<b>HDPE Systems</b>
Gaskets & Spare Parts
Preparation Equipment
Miscellaneous
Indices

**Replacement Gaskets – EPDM “E” Gaskets, Nitrile “T” Gaskets**  
**For #772, #770, #705, #707**

 GRINNELL Grade “E” EPDM	 GRINNELL Grade “T” Nitrile	 Standard Gasket	<i>Nominal</i>	<i>Part No.</i>	<i>Part No.</i>	<i>List Price</i>
			<i>Size</i>	<i>“E” EPDM</i>	<i>“T” Nitrile</i>	
			1"	01EPDME	01NITRILS	\$34.50
			1 <sup>1</sup> / <sub>4</sub> "	13EPDME	13NITRILS	\$37.00
			1 <sup>1</sup> / <sub>2</sub> "	15EPDME	15NITRILS	\$39.00
			2"	20EPDME	20NITRILS	\$37.50
			2 <sup>1</sup> / <sub>2</sub> "	25EPDME	25NITRILS	\$46.00
			3"	30EPDME	30NITRILS	\$49.00
			4"	40EPDME	40NITRILS	\$61.50
			5"	50EPDME	50NITRILS	\$79.00
			6"	60EPDME	60NITRILS	\$85.00
			8"	80EPDME	80NITRILS	\$116.50
			10"	10EPDME	10NITRILS	\$145.50
			12"	12EPDME	12NITRILS	\$169.50
			14"	14EPDME	14NITRILS	\$258.00
			16"	16EPDME	16NITRILS	\$355.50
			18"	18EPDME	18NITRILS	\$427.00
			20"	21EPDME	21NITRILS	\$656.00
			24"	24EPDME	24NITRILS	\$908.00

 Orders for items in shaded areas *cannot* be cancelled or returned.

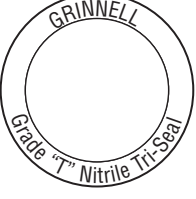
**Technical Data Sheet: G610**
**Replacement Tri-Seal Gaskets – EPDM “E” Gaskets, Nitrile “T” Gaskets**  
**For #772, #770, #705, #707**

 GRINNELL Grade “E” EPDM Tri-Seal	 GRINNELL Grade “T” Nitrile Tri-Seal	 Tri-Seal Gasket	<i>Nominal</i>	<i>Part No.</i>	<i>Part No.</i>	<i>List Price</i>
			<i>Size</i>	<i>“E” EPDM</i>	<i>“T” Nitrile</i>	
			1 <sup>1</sup> / <sub>4</sub> "	13EPDME3	13NITRILS3	\$68.50
			1 <sup>1</sup> / <sub>2</sub> "	15EPDME3	15NITRILS3	\$69.50
			2"	20EPDME3	20NITRILS3	\$71.50
			2 <sup>1</sup> / <sub>2</sub> "	25EPDME3	25NITRILS3	\$86.50
			3"	30EPDME3	30NITRILS3	\$86.50
			4"	40EPDME3	40NITRILS3	\$116.50
			5"	50EPDME3	50NITRILS3	\$204.50
			6"	60EPDME3	60NITRILS3	\$209.50
			8"	80EPDME3	80NITRILS3	\$216.50
			10"	10EPDME3	10NITRILS3	\$279.00
			12"	12EPDME3	12NITRILS3	\$332.00
			14"	14EPDME3	14NITRILS3	\$383.50
			16"	16EPDME3	16NITRILS3	\$529.50
			18"	18EPDME3	18NITRILS3	\$638.00
			20"	21EPDME3	21NITRILS3	\$979.50
			24"	24EPDME3	24NITRILS3	\$1,350.50

 Orders for items in shaded areas *cannot* be cancelled or returned.

**Technical Data Sheet: G610**

**Replacement Gaskets**  
**Grade "L" Silicone Gasket**  
**For #772, #770, #705, #707**

	<i>Nominal Size</i>	<i>Part Number</i>	<i>List Price</i>
	1 1/4"	13SILICONE	\$173.50
	1 1/2"	15SILICONE	\$181.50
	2"	20SILICONE	\$112.00
	2 1/2"	25SILICONE	\$130.00
	3"	30SILICONE	\$140.50
	4"	40SILICONE	\$204.00
	5"	50SILICONE	\$399.50
	6"	60SILICONE	\$438.00
	8"	80SILICONE	\$489.00
	10"	10SILICONE	\$635.00
	12"	12SILICONE	\$750.00
	14"	14SILICONE	\$1,145.50
16"	16SILICONE	\$1,467.50	

Orders for items in shaded areas **cannot** be cancelled or returned.

**Technical Data Sheet: G610**

**Replacement Gaskets**  
**Grade "O" Fluoroelastomer Gasket**  
**For #772, #770, #705, #707**

	<i>Nominal Size</i>	<i>Part Number</i>	<i>List Price</i>
	1 1/4"	13FLUORO	\$386.00
	1 1/2"	15FLUORO	\$407.50
	2"	20FLUORO	\$333.50
	2 1/2"	25FLUORO	\$377.00
	3"	30FLUORO	\$416.50
	4"	40FLUORO	\$682.00
	5"	50FLUORO	\$731.00
	6"	60FLUORO	\$895.50
	8"	80FLUORO	\$1,024.50
	10"	10FLUORO	\$1,334.50
	12"	12FLUORO	\$1,975.50
	14"	14FLUORO	POA
	16"	16FLUORO	POA
	18"	18FLUORO	POA
20"	21FLUORO	POA	
24"	24FLUORO	POA	

Orders for items in shaded areas **cannot** be cancelled or returned.

**Technical Data Sheet: G610**

Introduction  
 Couplings & Fittings  
 Mechanical Tees  
 Valves  
 Circuit Balancing Valves  
 Accessories  
 Copper Systems  
 Stainless Steel Systems  
 Plain End Systems  
 Stainless Steel G-PRESS  
 HDPE Systems  
 Gaskets & Spare Parts  
 Preparation Equipment  
 Miscellaneous  
 Indices

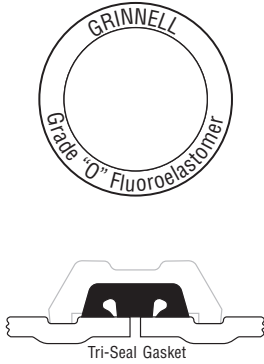
**Replacement Tri-Seal Gaskets**  
**Grade "O" Fluoroelastomer Gasket**  
**For #772, #770, #705, #707**

<i>Nominal Size</i>	<i>Part Number</i>	<i>List Price</i>
1"	01FLUOR03	\$441.50
1 <sup>1</sup> / <sub>4</sub> "	13FLUOR03	\$924.00
1 <sup>1</sup> / <sub>2</sub> "	15FLUOR03	\$560.50
2"	20FLUOR03	\$407.50
2 <sup>1</sup> / <sub>2</sub> "	25FLUOR03	POA
3"	30FLUOR03	POA
4"	40FLUOR03	POA
5"	50FLUOR03	POA
6"	60FLUOR03	\$1,127.50
8"	80FLUOR03	\$1,812.50
10"	10FLUOR03	\$1,958.50
12"	12FLUOR03	\$2,309.50
14"	14FLUOR03	POA
16"	16FLUOR03	POA
18"	18FLUOR03	POA
20"	21FLUOR03	POA
24"	24FLUOR03	POA

 Orders for items in shaded areas **cannot** be cancelled or returned.

**Technical Data Sheet: G610**

**Replacement Gaskets**  
**EPDM “E” Gaskets, Grade “T” Nitrile**  
**For # 716 Reducing Coupling**

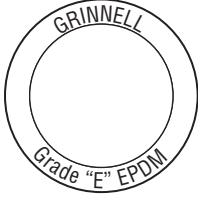
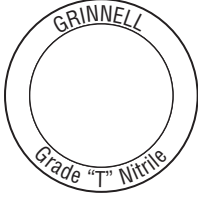
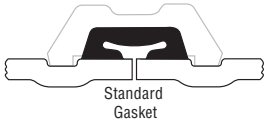
   Standard Gasket	Nominal Size	Part No. “E” EPDM	Part No. “T” Nitrile	List Price	
		2" x 1½"	2015EPDME	2015NITRILS	\$37.00
		2½" x 2"	2520EPDME	2520NITRILS	\$47.50
		3" x 2"	3020EPDME	3020NITRILS	\$54.00
		3" x 2½"	3025EPDME	3025NITRILS	\$54.00
		4" x 2"	4020EPDME	4020NITRILS	\$62.50
		4" x 2½"	4025EPDME	4025NITRILS	\$63.00
		4" x 3"	4030EPDME	4030NITRILS	\$65.00
		5" x 4"	5040EPDME	5040NITRILS	\$75.50
		6" x 4"	6040EPDME	6040NITRILS	\$85.50
	6" x 5"	6050EPDME	6050NITRILS	\$93.50	
	8" x 6"	8060EPDME	8060NITRILS	\$103.50	

Orders for items in shaded areas *cannot* be cancelled or returned.

**Technical Data Sheet: G610**

**Replacement Gaskets**  
**EPDM “E” Gaskets, Grade “T” Nitrile**  
**For #780 Snap Coupling**

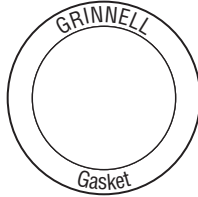
	Nominal Size	Grade “E” EPDM	Grade “T” Nitrile	List Price
	1"	78001EPDME	78001NITRILS	\$34.50
	1¼"	78013EPDME	78013NITRILS	\$37.00
	1½"	78015EPDME	78015NITRILS	\$39.00
	2"	78020EPDME	78020NITRILS	\$37.50
	2½"	78025EPDME	78025NITRILS	\$46.00
	3"	78030EPDME	78030NITRILS	\$49.00
	4"	78040EPDME	78040NITRILS	\$61.50
	5"	78050EPDME	78050NITRILS	\$79.00
	6"	78060EPDME	78060NITRILS	\$85.00
8"	78080EPDME	78080NITRILS	\$116.50	

Orders for items in shaded areas *cannot* be cancelled or returned.

**Technical Data Sheet: G610**

**#71H Hinged Flange Adapter Replacement**  
**“E” EPDM Gasket, “T” Nitrile Gasket & “O” Fluoroelastomer Gasket**

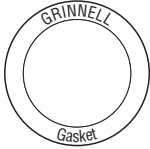
	Nominal Size	Part No. “E” EPDM	Part No. “T” Nitrile	List Price	Grade “O” Fluoroelastomer	List Price
	2"	71H20EPDME	71H20NITRILS	\$31.50	71H20FLUORO	POA
	2½"	71H25EPDME	71H25NITRILS	\$37.50	71H25FLUORO	POA
	3"	71H30EPDME	71H30NITRILS	\$40.00	71H30FLUORO	POA
	4"	71H40EPDME	71H40NITRILS	\$51.50	71H40FLUORO	POA
	5"	71H50EPDME	71H50NITRILS	\$62.50	71H50FLUORO	POA
	6"	7160EPDMEP	7160NITRILSP	\$69.50	7160FLUOROP	POA
	8"	7180EPDMEP	7180NITRILSP	\$93.50	7180FLUOROP	POA
	10"	7110EPDMEP	7110NITRILSP	\$118.50	7110FLUOROP	POA
12"	7112EPDMEP	7112NITRILSP	\$138.00	7112FLUOROP	POA	

 Orders for items in shaded areas *cannot* be cancelled or returned.

**Technical Data Sheet: G155**
**#71 Flange Adapter Replacement**  
**“E” EPDM Gasket, “T” Nitrile Gasket**

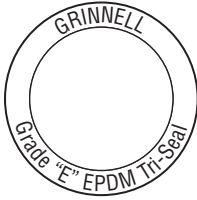
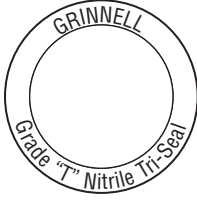
 	Nominal Size	Part No. “E” EPDM	Part No. “T” Nitrile	List Price
	2"	7120EPDME	7120NITRILS	\$31.50
	2½"	7125EPDME	7125NITRILS	\$37.50
	3"	7130EPDME	7130NITRILS	\$40.00
	4"	7140EPDME	7140NITRILS	\$51.50
	5"	7150EPDME	7150NITRILS	\$62.50
	6"	7160EPDME	7160NITRILS	\$69.50
	8"	7180EPDME	7180NITRILS	\$93.50
	10"	7110EPDME	7110NITRILS	\$118.50
	12"	7112EPDME	7112NITRILS	\$138.00
	14"	7114EPDME	7114NITRILS	\$170.50
	16"	7116EPDME	7116NITRILS	\$189.00
	18"	7118EPDME	7118NITRILS	\$275.50
	20"	7121EPDME	7121NITRILS	\$297.50
24"	7124EPDME	7124NITRILS	\$330.00	

 Orders for items in shaded areas *cannot* be cancelled or returned.

**Technical Data Sheet: G610**
**#71 Flange Washer Adapter, Carbon Steel or Stainless Steel**

	Nominal Size	Carbon Steel		Stainless Steel	
		Part Number	List Price	Part Number	List Price
	2"	7120FWC	\$100.00	7120FW	POA
	2½"	7125FWC	\$105.00	7125FW	POA
	3"	7130FWC	\$123.00	7130FW	POA
	4"	7140FWC	\$142.50	7140FW	POA
	5"	7150FWC	\$172.50	7150FW	POA
	6"	7160FWC	\$197.00	7160FW	POA
	8"	7180FWC	\$248.50	7180FW	POA
	10"	7110FWC	\$343.50	7110FW	POA
	12"	7112FWC	\$502.00	7112FW	POA
	14"	7114FWC	\$547.00	–	–
	16"	7116FWC	\$971.50	–	–
	18"	7118FWC	\$1,036.00	–	–
	20"	7121FWC	POA	–	–
	24"	7124FWC	POA	–	–

 Orders for items in shaded areas *cannot* be cancelled or returned.

**Technical Data Sheet: G610**

 See latest catalog or technical data sheets for specific approvals, listings, and design parameters.  
 POA = Price on availability. Prices subject to change without notice.



# Tyco Mechanical Products

## Section 12 – Gaskets & Spare Parts



### #730 Replacement "E" EPDM Gasket

<i>Nominal Size</i>	<i>"E" EPDM Gasket</i>	<i>"T" Nitrile Gasket</i>	<i>List Price</i>
2" x 1/2"	730EGS-1	730TGS-1	\$16.50
2" x 3/4"	730EGS-1	730TGS-1	\$16.50
2" x 1"	730EGS-1	730TGS-1	\$16.50
2" x 1 1/4"	730EGS-2	730TGS-2	\$19.50
2" x 1 1/2"	730EGS-2	730TGS-2	\$19.50
2 1/2" x 1 1/2"	730EGS-1	730TGS-1	\$16.50
2 1/2" x 3/4"	730EGS-1	730TGS-1	\$16.50
2 1/2" x 1"	730EGS-1	730TGS-1	\$16.50
2 1/2" x 1 1/4"	730EGS-3	730TGS-3	\$19.50
2 1/2" x 1 1/2"	730EGS-3	730TGS-3	\$19.50
2 1/2" x 2"	730EGS-3	730TGS-3	\$19.50
3" x 1 1/2"	730EGS-1	730TGS-1	\$16.50
3" x 3/4"	730EGS-1	730TGS-1	\$16.50
3" x 1"	730EGS-1	730TGS-1	\$16.50
3" x 1 1/4"	730EGS-2	730TGS-2	\$19.50
3" x 1 1/2"	730EGS-3	730TGS-3	\$19.50
3" x 2"	730EGS-4	730TGS-4	\$19.50
4" x 1 1/2"	730EGS-1	730TGS-1	\$16.50
4" x 3/4"	730EGS-1	730TGS-1	\$16.50
4" x 1"	730EGS-1	730TGS-1	\$16.50
4" x 1 1/4"	730EGS-2	730TGS-2	\$19.50
4" x 1 1/2"	730EGS-3	730TGS-3	\$19.50
4" x 2"	730EGS-4	730TGS-4	\$19.50
4" x 2 1/2"	730EGS-5	730TGS-5	\$22.00
4" x 3"	730EGS-7	730TGS-7	\$24.00
5" x 1 1/2"	730EGS-3	730TGS-3	\$19.50
5" x 2"	730EGS-4	730TGS-4	\$19.50
5" x 2 1/2"	730EGS-5	730TGS-5	\$22.00
5" x 3"	730EGS-7	730TGS-7	\$24.00
6" x 1 1/4"	730EGS-3	730TGS-3	\$19.50
6" x 1 1/2"	730EGS-3	730TGS-3	\$19.50
6" x 2"	730EGS-4	730TGS-4	\$19.50
6" x 2 1/2"	730EGS-6	730TGS-6	\$23.00
6" x 3"	730EGS-8	730TGS-8	\$24.00
6" x 4"	730EGS-9	730TGS-9	\$32.00
8" x 2 1/2"	730EGS-6	730TGS-6	\$23.00
8" x 3"	730EGS-8	730TGS-8	\$24.00
8" x 4"	730EGS-9	730TGS-9	\$32.00

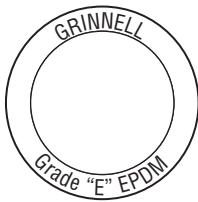

Orders for items in shaded areas **cannot** be cancelled or returned.

**Technical Data Sheet: G610**

Introduction
Couplings & Fittings
Mechanical Tees
Valves
Circuit Balancing Valves
Accessories
Copper Systems
Stainless Steel Systems
Plain End Systems
Stainless Steel G-PRESS
HDPE Systems
Gaskets & Spare Parts
Preparation Equipment
Miscellaneous
Indices

**Replacement Gaskets**  
**EPDM “E” Gaskets, Nitrile “T” Gaskets For #702 Outlet Coupling**

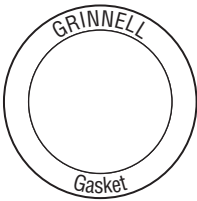
	<i>Nominal Size</i>	<i>Grade “E” EPDM Part No.</i>	<i>Grade “T” Nitrile Part No.</i>	<i>List Price</i>
	1½" x ½"	7021505EPDME	7021505NITRILS	\$60.50
	1½" x ¾"	7021575EPDME	7021575NITRILS	\$60.50
	1½" x 1"	7021501EPDME	7021501NITRILS	\$60.50
	2" x ½"	7022005EPDME	7022005NITRILS	\$61.50
	2" x ¾"	7022075EPDME	7022075NITRILS	\$61.50
	2" x 1"	7022001EPDME	7022001NITRILS	\$61.50
	2½" x ½"	7022505EPDME	7022505NITRILS	\$125.50
	2½" x ¾"	7022575EPDME	7022575NITRILS	\$125.50
	2½" x 1"	7022501EPDME	7022501NITRILS	\$125.50
2½" x 1¼"	7022513EPDME	7022513NITRILS	\$140.50	
2½" x 1½"	7022515EPDME	–	\$140.50	
3" x ¾"	7023075EPDME	7023075NITRILS	\$102.00	
3" x 1"	7023001EPDME	7023001NITRILS	\$144.50	
3" x 1¼"	7023013EPDME	7023013NITRILS	\$144.50	
3" x 1½"	7023015EPDME	7023015NITRILS	\$144.50	
4" x ¾"	7024075EPDME	7024075NITRILS	\$144.50	
4" x 1"	7024001EPDME	7024001NITRILS	\$144.50	
4" x 1½"	7024015EPDME	7024015NITRILS	\$224.50	
4" x 2"	7024020EPDME	7024020NITRILS	\$224.50	
6" x 1"	7026001EPDME	7026001NITRILS	\$293.00	
6" x 1½"	7026015EPDME	7026015NITRILS	\$293.00	
6" x 2"	7026020EPDME	7026020NITRILS	\$293.00	

 Orders for items in shaded areas *cannot* be cancelled or returned.

**Technical Data Sheet: G610**
**Replacement Gaskets**  
**with Grade “EHT” EPDM or Grade “T” Nitrile Center-Stop Push-On Style Gasket**  
**For #740 Rapid Installation Pivot-Bolt (GRIP) Rigid Coupling**

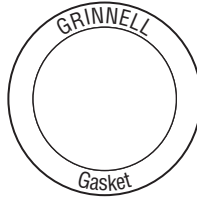
	<i>Nominal Size</i>	<i>Grade “E” EPDM Part No.</i>	<i>Grade “T” Nitrile Part No.</i>	<i>List Price</i>
	2"	74020EPDME	74020NITRILS	\$55.75
	2½"	74025EPDME	74025NITRILS	\$61.00
	3"	74030EPDME	74030NITRILS	\$69.50
	4"	74040EPDME	74040NITRILS	\$93.50
	5"	74050EPDME	74050NITRILS	\$132.50
	6"	74060EPDME	74060NITRILS	\$156.50
	8"	74080EPDME	74080NITRILS	\$227.50

 Orders for items in shaded areas *cannot* be cancelled or returned.

**Technical Data Sheet: G144**

**Replacement Gaskets – Grade “EN” Tri-Seal  
(for #672 Coupling)**

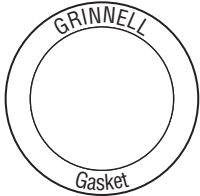
	Nominal Size	Part Number	List Price
	2"	20EN3	\$48.00
	2½"	25EN3	\$52.00
	3"	30EN3	\$55.00
	4"	40EN3	\$80.00
	5"	50EN3	\$132.00
	6"	60EN3	\$173.50
	8"	80EN3	\$269.50

Orders for items in shaded areas *cannot* be cancelled or returned.

**Technical Data Sheet: G610**

**Replacement Gaskets – Grade “EHT” EPDM Center-Stop Push-On Style Gasket  
(for #640 Coupling)**

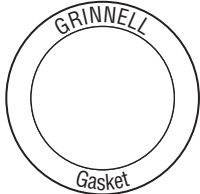
	Nominal Size	Part Number	List Price
	2"	964020EN3	\$46.00
	2½"	964025EN3	\$50.00
	3"	964030EN3	\$53.00
	4"	964040EN3	\$77.00
	5"	964050EN3	\$127.50
	6"	964060EN3	\$167.00
	8"	964080EN3	\$260.00

Orders for items in shaded areas *cannot* be cancelled or returned.

**Technical Data Sheet: G610**

**Replacement Gaskets – Grade “EH” EPDM Gasket  
(for #616 Reducing Coupling)**

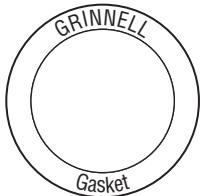
	Nominal Size	Part Number	List Price
	2½" x 2"	6162520NSF	\$44.50
	3" x 2"	6163020NSF	\$50.50
	3" x 2½"	6163025NSF	\$50.50
	4" x 2½"	6164025NSF	\$59.00
	4" x 3"	6164030NSF	\$61.00
	5" x 4"	6165040NSF	\$71.00
	6" x 4"	6166040NSF	\$80.50

Orders for items in shaded areas *cannot* be cancelled or returned.

**Technical Data Sheet: G610**

Introduction  
Couplings & Fittings  
Mechanical Tees  
Valves  
Circuit Balancing Valves  
Accessories  
Copper Systems  
Stainless Steel Systems  
Plain End Systems  
Stainless Steel G-PRESS  
HDPE Systems  
Gaskets & Spare Parts  
Preparation Equipment  
Miscellaneous  
Indices

**Replacement Gaskets – Grade “EN” EPDM Gasket**  
**(for #617 Transition Coupling for Joining IPS to Copper Tubing)**

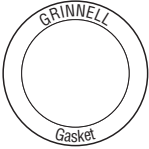
	<i>Nominal Size</i>	<i>Part Number</i>	<i>List Price</i>
	2"	61720NSF	\$55.00
	2½"	61725NSF	\$60.00
	3"	61730NSF	\$65.00
	4"	61740NSF	\$75.00

 Orders for items in shaded areas *cannot* be cancelled or returned.

**Technical Data Sheet: G610**
**Replacement Gaskets – Grade “EN” EPDM**  
**(for #61H Flange Adapter - Hinged)**

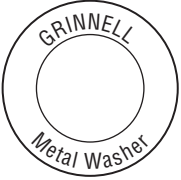
	<i>Nominal Size</i>	<i>Part Number</i>	<i>List Price</i>
	2"	61H20NSF	\$35.00
	2½"	61H25NSF	\$39.00
	3"	61H30NSF	\$42.50
	4"	61H40NSF	\$53.00
	5"	61H50NSF	\$64.50
	6"	61H60NSF	\$74.50

 Orders for items in shaded areas *cannot* be cancelled or returned.

**Technical Data Sheet: G610**
**Replacement Gaskets – Grade “EN” EPDM**  
**(for #61 Flange Adapter)**

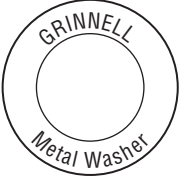
	<i>Nominal Size</i>	<i>Part Number</i>	<i>List Price</i>
	2"	6120NSF	\$38.50
	2½"	6125NSF	\$43.00
	3"	6130NSF	\$47.00
	4"	6140NSF	\$58.50
	5"	6150NSF	\$71.00

 Orders for items in shaded areas *cannot* be cancelled or returned.

**Technical Data Sheet: G610**

**Phenolic Washer  
 (for #61 Flange Adapter)**

	Nominal Size	Part Number	List Price
	2"	61PW20	\$60.50
	2½"	61PW25	\$65.50
	3"	61PW30	\$70.50
	4"	61PW40	\$111.50
	5"	61PW50	\$121.00
	6"	61PW60	\$137.50

Orders for items in shaded areas **cannot** be cancelled or returned.

**Technical Data Sheet: G610**

**Replacement Gaskets  
 EPDM "E" Gaskets, Nitrile "T" Gaskets For #909 Plain End Coupling**

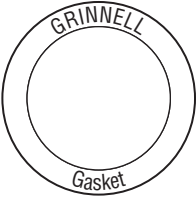
	Nominal Size	Grade "E" EPDM Part No.	Grade "T" Nitrile Part No.	List Price
	2"	90920EPDME	90920NITRILS	\$48.50
	2½"	90925EPDME	90925NITRILS	\$51.50
	3"	90930EPDME	90930NITRILS	\$56.50
	4"	90940EPDME	90940NITRILS	\$81.50
	6"	90960EPDME	90960NITRILS	\$117.00
	8"	90980EPDME	90980NITRILS	\$152.00
	10"	90910EPDME	90910NITRILS	\$195.00
	12"	90912EPDME	90912NITRILS	\$236.50
	14"	90914EPDME	90914NITRILS	\$359.50
	16"	90916EPDME	90916NITRILS	\$425.50
	18"	90918EPDME	90918NITRILS	\$680.00

Orders for items in shaded areas **cannot** be cancelled or returned.

**Technical Data Sheet: G610**

Introduction  
 Couplings & Fittings  
 Mechanical Tees  
 Valves  
 Circuit Balancing Valves  
 Accessories  
 Copper Systems  
 Stainless Steel Systems  
 Plain End Systems  
 Stainless Steel G-PRESS  
 HDPE Systems  
 Gaskets & Spare Parts  
 Preparation Equipment  
 Miscellaneous  
 Indices

**HDPE – #9094 Replacement Gaskets “E”**

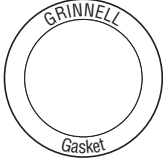
	Nominal Size	Model Number	List
	4"	909440EPDME	\$169.50
	6"	909460EPDME	\$172.50
	8"	909480EPDME	\$176.50

 Orders for items in shaded areas *cannot* be cancelled or returned.

**Technical Data Sheet: G610**
**HDPE – #9095 Replacement Gaskets “E”**

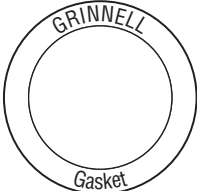
	Nominal Size	Model Number	List
	2"	909520EPDME	\$48.50
	3"	909530EPDME	\$56.50
	4"	909540EPDME	\$81.50
	6"	909560EPDME	\$117.00
	8"	909580EPDME	\$152.00
	10"	909510EPDME	\$195.00
	12"	909512EPDME	\$236.50
	14"	909514EPDME	\$359.50
	16"	909516EPDME	\$425.50
	18"	909518EPDME	\$446.00
	20"	909521EPDME	\$482.00

 Orders for items in shaded areas *cannot* be cancelled or returned.

**Technical Data Sheet: G610**
**HDPE – #9097 Replacement Gaskets “E”**

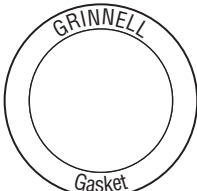
	Nominal Size	Model Number	List
	2"	909720EPDME	\$39.00
	3"	909730EPDME	\$49.00
	4"	909740EPDME	\$61.50
	6"	909760EPDME	\$85.00
	8"	909780EPDME	\$116.50
	10"	909710EPDME	\$145.50

 Orders for items in shaded areas *cannot* be cancelled or returned.

**Technical Data Sheet: G610**

# Tyco Mechanical Products

## Section 12 – Gaskets & Spare Parts

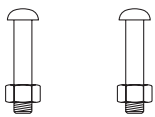

Coupling Nut and Bolt Kit						
	Nominal Size	Qty/Kit	Carbon Steel		Stainless Steel	
			Part Number	List Price	Part Number	List Price
				3/8" x 2 1/4"	2	NB37225
	1/2" x 3"	2	NB50300	\$19.00	NBSS50300	\$107.50
	1/2" x 3 5/8"	1	NB50362	\$9.50	-	-
	5/8" x 2 3/4"	2	NB62275	\$22.00	-	-
	5/8" x 3 1/4"	2	NB62325	\$22.00	NBSS62325	\$105.50
	5/8" x 3 1/2"	2	NB62350	\$26.50	-	-
	5/8" x 3 1/2"	1	NB62450	\$12.50	-	-
	5/8" x 4 3/4"	2	NB62475	\$37.00	NBSS62475	\$684.50
	3/4" x 4 1/4"	2	NB75425	\$25.50	-	-
	3/4" x 4 3/4"	2	NB75475	\$34.00	NBSS75475	\$452.00
	7/8" x 5 1/2"	2	NB87550	\$51.50	-	-
	7/8" x 6 1/2"	2	NB87650	\$56.50	NBSS87650	\$606.50
	1" x 5 1/2"	3	NB10550	\$56.50	NBSS10550	\$650.00
	1" x 6 1/2"	2	NB10650	\$59.50	NBSS10650	\$814.50
	1 1/8" x 5 3/4"	4	NB12575	\$76.00	-	-

Orders for items in shaded areas **cannot** be cancelled or returned.

All standard couplings can be provided with stainless steel nuts and bolts upon request.

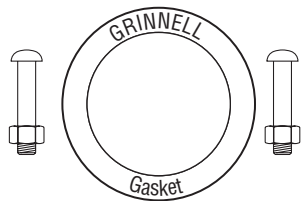
#71 Nut, Bolt, and Gasket Kit			
	Nominal Size	Part Number	List Price
	2"	50240P	POA
	2 1/2"	50241P	POA
	3"	50242P	POA
	4"	50243P	POA
	5"	50248P	POA
	6"	50244P	POA
	8"	50245P	POA
	10"	50246P	POA
	12"	50247P	POA

Orders for items in shaded areas **cannot** be cancelled or returned.

**Technical Data Sheet: G610**

Introduction  
Couplings & Fittings  
Mechanical Tees  
Valves  
Circuit Balancing Valves  
Accessories  
Copper Systems  
Stainless Steel Systems  
Plain End Systems  
Stainless Steel G-PRESS  
HDPE Systems  
Gaskets & Spare Parts  
Preparation Equipment  
Miscellaneous  
Indices

**Pipe Tape Chrome Plated with GRINNELL Logo**

	<i>Part Number</i>	<i>List Price</i>
	PT1000	\$70.50

**GRINNELL Gasket Lubricant**

	<i>Nominal Size</i>	<i>Part Number</i>	<i>List Price</i>
	1 Quart	32005	\$41.00

 Orders for items in shaded areas **cannot** be cancelled or returned.

**GRINNELL Silicone Gasket Lubricant**  
**Recommended for use with Tri-Seal Gasket**  
**Dow Corning\* #DC No. 7**

	<i>Nominal Size</i>	<i>Part Number</i>	<i>List Price</i>
	5.3 oz. Tube	32037	\$134.00
	8 lb. Can	32038	\$2,432.00

 Orders for items in shaded areas **cannot** be cancelled or returned.

\* Dow Corning is a trademark of Dow Corning Corporation.

 See latest catalog or technical data sheets for specific approvals, listings, and design parameters.  
 POA = Price on availability. Prices subject to change without notice.



# Tyco Mechanical Products

## Section 13 – Preparation Equipment



Roll Grooving Machine Selection Chart											
Machine Type	Pace Model	Size Range				Drive	Rolls Supplied			Part No.	List Price **
		Sch. 40	Sch. 10	Std. Wall	Copper		Size	Steel	Copper		
<b>Portable with Electric Motor</b>	1112	1" – 12"	–	–	2" – 8"	1½ HP, 110V	1" – 12"	■		41048	\$7,380.00
	1023	1¼" – 12"	–	12" – 24"	2" – 8"	1½ HP, 110V	1¼" – 12"	■		41029	\$10,915.00
							2" – 12"	■		41250	\$10,388.00
							1¼" – 24"	■		41251	\$12,160.00
							2" – 24"	■		41252	\$11,628.00
<b>Portable for Ridgid® 300</b>	1012	1" – 12"	–	–	2" – 8"	Ridgid® 300	1" – 12"	■		41041	\$4,096.00
	1022	1¼" – 12"	–	12" – 16"	2" – 8"	Ridgid® 300	1¼" – 16"	■		41027	\$9,220.00
	1041	1" – 6"	1" – 12"	–	2" – 8"	Ridgid® 300	1" – 12"	■		41018	\$2,869.00
<b>Mini-Mites</b>	1039-66	1¼" – 6"	–	–	2" – 8"	Ridgid® 300, Hand Crank	2" – 8" CTS		■	41047	\$815.50
	1039	1¼" – 6"	–	–	2" – 8"	Ridgid® 300, Hand Crank	1¼" – 6" IPS	■		41017	\$815.50
	1034	1¼" – 6"	–	–	–	Ridgid® 300	1¼" – 6" IPS	■		41015	\$607.00
	1066	–	–	–	2" – 8"	Ridgid® 300	2" – 8" CTS		■	41014	\$607.00
<b>Automated</b>	2021	1¼" – 12"	–	12" – 24"	2" – 8"	3 HP, 220V	1¼" – 12"	■		41257	\$19,183.00
							2" – 12"	■		41258	\$18,656.00
							1¼" – 24"	■		41032	\$20,429.00
							2" – 24"	■		41259	\$19,847.00
	2050	4" – 12"	4" – 30"	12" – 30"	–	5 HP, 220V	4" – 6"	■		41033	\$36,189.00
2112	1" – 12"	–	–	2" – 8"	½ HP, 110V	1" – 12"	■		41210	POA	
<b>Portable Cut Groover</b>	1000	2" – 8"	–	–	–	1 HP, 115V	2" – 8"			41260	\$8,592.00
		2" – 12"							41261	\$9,400.00	

\*\* Accessories not included, refer to Accessory Table Below.

Accessories						
Item	Pace Model	Size Range	Capacity	Part No.	List Price	
<b>Pipe Stands</b>	4031	1" – 4"	600 Lbs.	41037	\$438.00	
	4000	2" – 8"	900 Lbs.	41038	\$541.00	
	4033	2" – 14"	1,200 Lbs.	41039	\$678.00	
	4040	12" – 24"	4,000 Lbs.	41040	\$1,720.00	
<b>Nipple Bracket</b>	4037	Fits Model 1021 / 22 / 23 / 2021		–	41035	\$547.50
	4045	4" – 12" Fits Model 1012 / 1112		–	41512	\$455.00
<b>Mounting Feet</b>	4039	Fits Portable Roll Groovers and Model 1000		–	41034	\$138.00
	4046	PA Mounting Feet		–	41013	\$138.00
<b>Porta-Bore</b>	3013	Up to 4¼" Holes in Pipe 1¼" – 12"		–	41049	\$2,262.00

Introduction  
Couplings & Fittings  
Mechanical Tees  
Valves  
Circuit Balancing Valves  
Accessories  
Copper Systems  
Stainless Steel Systems  
Plain End Systems  
Stainless Steel G-PRESS  
HDPE Systems  
Gaskets & Spare Parts  
Preparation Equipment  
Miscellaneous  
Indices

**Roll Selection Chart**

Machine	Pipe	Size	Top		Size	Bottom		Parts	Part Number	List Price
			Part No.	List Price		Part No.	List Price			
1021, 1023, 2021	Sch. 40	1 1/4" – 1 1/2"	41262	\$306.00	1 1/4" – 1 1/2"	41281	\$222.00			
		2" – 3 1/2"	41263	\$267.00	2" – 3 1/2"	41282	\$206.00			
		4" – 6"	41264	\$238.00	4" – 6"	41283	\$312.50			
		8" – 12"	41265	\$238.00	8" – 12"	41284	\$372.00			
	Std. Wall	14" – 16"	41266	\$223.00	14" – 16"	41285	\$409.50			
		18" – 24"	41267	\$223.00	18" – 24"	41286	\$409.50			
Copper Tube	2" – 8"	41268	\$267.00	2" – 8"	41287	\$206.00	Depth Gauge 4043	41509	\$30.50	
1010, 2010	Sch. 10, Sch. 40	1 1/2" – 6"	41269	\$223.00	1 1/2"	41288	\$206.00			
			–	–	2" – 3 1/2"	41289	\$206.00			
			–	–	4" – 6"	41290	\$300.00			
	Sch. 10	8" – 12"	41270	\$223.00	8" – 12"	41291	\$300.00			
1040, 2040	Sch. 40	1" – 1 1/2"	41271	\$183.00	1" – 1 1/2"	41292	\$183.00			
		1" – 6"	41272	\$161.50	1" – 6"	41293	\$153.00			
		2" – 6"	41273	\$183.00	–	–				
	Sch. 10	8" – 12"	41274	\$161.50	8" – 12"	41294	\$253.00			
	Copper Tube	2" – 8"	41275	\$162.50	2" – 8"	41295	\$156.50	Depth Gauge 4021	41510	\$30.50
1012, 1112, 2112	Sch. 40	1" – 1 1/2"	41276	\$183.00	1" – 1 1/2"	41296	\$183.00			
		2" – 6"	41277	\$183.00	2" – 6"	41297	\$153.00			
		8" – 12"	41278	\$183.00	8" – 12"	41298	\$255.00			
	Copper Tube	2" – 8"	41506	\$183.00	2" – 8"	41507	\$156.50	Depth Gauge 4021	41510	\$30.50
1021, 1022, 1023, 2021	SS 10 Ga.				2" – 3 1/2"	41299	\$225.50			
					4" – 6"	41500	\$343.50			
					8" – 12"	41501	\$409.50			
					14" – 16"	41504	\$449.50			
					18" – 24"	41505	\$449.50			
1040, 1041, 1112, 2112	SS 10 Ga.				2" – 6"	41502	\$170.00			
					8" – 12"	41503	\$303.00			
1034, 1039	Sch. 40	1 1/4" – 6", w/ brg.	41279	\$42.75				1034 Drive Shaft 1 1/4" – 6"	41511	\$67.25
								1039 Drive Shaft 1 1/4" – 6"	41513	\$85.50
								Depth Gauge 4021	41510	\$30.50
1039	Copper Tube	2" – 8", w/ brg.	41280	\$55.25			Depth Gauge 4021	41510	\$30.50	
1066	Copper Tube	2" – 8", w/ brg.	41508	\$55.25				Drive Shaft 2" – 8"	41514	\$67.25
								Depth Gauge 4021	41510	\$30.50

Brg. = Bottom Roll Grooved

See latest catalog or technical data sheets for specific approvals, listings, and design parameters.

POA = Price on availability. Prices subject to change without notice.

**Grooved Couplings – Pieces Per Carton/Case**

Nominal Size	#740 Pivot-Bolt GRIP Coupling	#705 Flex Coupling	#707 HD Flex Coupling	#772 Rigid Coupling	#71 Flange Adapter	#770 Heavy Duty Coupling	Nominal Size	#716 Reducing Coupling
1"	-	-	40	-	-	-	2" x 1 1/2"	20
1 1/4"	-	32	-	32	-	-	2 1/2" x 2"	20
1 1/2"	-	32	480	28	-	-	3" x 2"	12
2"	350	480	385	385	210	385	3" x 2 1/2"	12
2 1/2"	300	350	350	350	210	315	4" x 2"	8
3"	240	270	240	240	124	24	4" x 2 1/2"	8
4"	120	175	150	150	124	12	4" x 3"	8
5"	120	96	80	100	30	-	5" x 4"	80
6"	80	100	64	80	30	6	6" x 4"	64
8"	48	48	36	44	30	33	6" x 5"	64
10"	-	24	24	24	24	18	8" x 6"	36
12"	-	20	20	20	24	20	-	-
14"	-	-	12	12	12	-	-	-
16"	-	-	12	12	6	-	-	-
18"	-	-	6	6	5	-	-	-
20"	-	-	3	3	5	-	-	-
24"	-	-	3	3	5	-	-	-

**Grooved Fittings – Pieces Per Carton/Case**

Nominal Size	#210 90 Elbow	#201 45 Elbow	#219 Tee	#260 Cap
1 1/4"	40	45	28	294
1 1/2"	36	60	28	210
2"	18	24	10	140
2 1/2"	12	18	8	84
3"	6	10	12	63
4"	56	96	46	30
5"	35	140	36	392
6"	24	30	12	288
8"	11	16	8	160
10"	7	9	5	96
12"	5	9	8	63
14"	2	-	-	-
16"	-	-	-	-
18"	-	-	-	-
20"	-	-	-	-
24"	-	-	-	-
-	-	-	-	-
-	-	-	-	-
-	-	-	-	-
-	-	-	-	-



<b>Grooved Fittings – Pieces Per Carton/Case</b>		
<b>Nom Size</b>	<b>#250 Conc Reducer</b>	<b>#251 Ecc Reducer</b>
1 1/2" x 1 1/4"	70	-
2 1/2" x 1 1/4"	36	-
2 1/2" x 1 1/2"	36	-
2 1/2" x 2"	36	-
3" x 1 1/2"	24	-
3" x 2"	24	18
3" x 2 1/2"	24	18
4" x 2"	10	144
4" x 2 1/2"	10	144
4" x 3"	10	10
5" x 3"	147	147
5" x 4"	147	98
6" x 2"	72	-
6" x 2 1/2"	72	-
6" x 3"	72	36
6" x 4"	72	36
6" x 5"	216	36
8" x 3"	80	-
8" x 4"	40	-
8" x 5"	40	-
8" x 6"	32	-
10" x 6"	13	-
10" x 8"	13	-
12" x 6"	9	-
12" x 8"	9	-
12" x 10"	36	-

See latest catalog or technical data sheets for specific approvals, listings, and design parameters.  
POA = Price on availability. Prices subject to change without notice.

**Grooved Fittings – Pieces Per Carton/Case**

<i>Nominal Size</i>	<i>#730 Mechanical Tee</i>	<i>Nominal Size</i>	<i>#730 Mechanical Tee (cont.)</i>	<i>Nominal Size</i>	<i>#221 Reducing Tee</i>
2" x 1/2"	15	4" x 1/2"	8	2" x 2" x 1 1/2"	24
2" x 3/4"	15	4" x 3/4"	8	2 1/2" x 2 1/2" x 2"	8
2" x 1"	15	4" x 1"	8	3" x 3" x 1"	12
2" x 1 1/4"	15	4" x 1 1/4"	8	3" x 3" x 1 1/2"	4
2" x 1 1/2"	12	4" x 1 1/2"	8	3" x 3" x 2"	3
2 1/2" x 1 1/2"	14	4" x 2"	6	3" x 3" x 2 1/2"	3
2 1/2" x 3/4"	14	4" x 2 1/2"	5	4" x 4" x 2"	46
2 1/2" x 1"	14	4" x 3"	4	4" x 4" x 3"	46
2 1/2" x 1 1/4"	14	5" x 2"	4	5" x 5" x 2 1/2"	18
2 1/2" x 1 1/2"	20	5" x 2 1/2"	8	5" x 5" x 3"	18
3" x 1/2"	11	6" x 1 1/2"	8	5" x 5" x 4"	36
3" x 3/4"	11	6" x 2"	7	6" x 6" x 2"	12
3" x 1"	11	6" x 2 1/2"	7	6" x 6" x 2 1/2"	48
3" x 1 1/4"	11	6" x 3"	6	6" x 6" x 3"	48
3" x 1 1/2"	11	6" x 4"	6	6" x 6" x 4"	48
3" x 2"	12	8" x 2 1/2"	4	8" x 8" x 4"	8
-	-	8" x 3"	4	8" x 8" x 6"	8
-	-	8" x 4"	4	-	-

**Copper System Grooved Couplings  
– Pieces Per Carton/Case**

<i>Nominal Size</i>	<i>#672 Rigid Coupling</i>	<i>#61 Flange Adapter</i>	<i>#640 Pivot-Bolt Rigid Couplings</i>
2"	520	210	20
2 1/2"	385	21	16
3"	270	124	12
4"	175	124	8
5"	120	30	100
6"	100	30	100
8"	60	-	60

Introduction  
Couplings & Fittings  
Mechanical Tees  
Valves  
Circuit Balancing Valves  
Accessories  
Copper Systems  
Stainless Steel Systems  
Plain End Systems  
Stainless Steel G-PRESS  
HDPE Systems  
Gaskets & Spare Parts  
Preparation Equipment  
Miscellaneous  
Indices

Part No. ....	Page	Part No. ....	Page	Part No. ....	Page	Part No. ....	Page	Part No. ....	Page	Part No. ....	Page
01EPDME	92	20112GS	16	21115S	17	2212015S	24	2503025S	27	26012T1S	37
01FLUORO3	94	20112S	16	21120GS	17	2212520GS	24	2504020GS	27	26012T75S	37
01NITRILS	92	20113GS	16	21120S	17	2212520S	24	2504020S	27	26012TS	37
05SSPRESSE	89	20113S	16	21125GS	17	2213010GS	24	2504025GS	27	26013GS	36
05SSPRESSE	89	20115GS	16	21125S	17	2213010S	24	2504025S	27	26013S	36
05SSPRESST	89	20115S	16	21130GS	17	2213015GS	24	2504030GS	27	26013TS	37
08SSPRESSE	89	20120GS	16	21130S	17	2213015S	24	2504030S	27	26015GS	36
08SSPRESSE	89	20120S	16	21140GS	17	2213020GS	24	2505030GS	27	26015S	36
08SSPRESST	89	20125GS	16	21140S	17	2213020S	24	2505030S	27	26015TS	37
10EPDME	92	20125S	16	21150GS	17	2213025GS	24	2505040GS	27	26020GS	36
10EPDME3	92	20130GS	16	21150S	17	2213025S	24	2505040S	27	26020S	36
10FLUORO	93	20130S	16	21160GS	17	2214020GS	24	2506020GS	27	26020T1S	37
10FLUORO3	94	20140GS	16	21160S	17	2214020S	24	2506020S	27	26020T75S	37
10NITRILS	92	20140S	16	21180GS	17	2214025GS	24	2506025GS	27	26020TS	37
10NITRILS3	92	20150GS	16	21180S	17	2214025S	24	2506025S	27	26025GS	36
10SILICONE	93	20150S	16	21213GS	17	2214030GS	24	2506030GS	27	26025S	36
10SSPRESSE	89	2015EPDME	95	21213S	17	2214030S	24	2506030S	27	26025T1S	37
10SSPRESSE	89	2015NITRILS	95	21215GS	17	2215025GS	24	2506040GS	27	26025T75S	37
10SSPRESST	89	20160GS	16	21215S	17	2215025S	24	2506040S	27	26025TS	37
12EPDME	92	20160S	16	21220GS	17	2215030GS	24	2506050GS	27	26030GS	36
12EPDME3	92	20180GS	16	21220S	17	2215030S	24	2506050S	27	26030S	36
12FLUORO	93	20180S	16	21225GS	17	2215040GS	24	2508030GS	27	26030T1S	37
12FLUORO3	94	201L14GS	18	21225S	17	2215040S	24	2508030S	27	26030T75S	37
12NITRILS	92	201L14S	18	21230GS	17	2216020GS	24	2508040GS	27	26030TS	37
12NITRILS3	92	201L16GS	18	21230S	17	2216020S	24	2508040S	27	26040GS	36
12SILICONE	93	201L16S	18	21240GS	17	2216025GS	24	2508050GS	27	26040S	36
13EPDME	92	20EN3	99	21240S	17	2216025S	24	2508050S	27	26040T1S	37
13EPDME3	92	20EPDME	92	21250GS	17	2216030GS	24	2508060GS	27	26040T75S	37
13FLUORO	93	20EPDME3	92	21250S	17	2216030S	24	2508060S	27	26040TS	37
13FLUORO3	94	20FLUORO	93	21260GS	17	2216040GS	24	2513020GS	28	26050GS	36
13NITRILS	92	20FLUORO3	94	21260S	17	2216040S	24	2513020S	28	26050S	36
13NITRILS3	92	20NITRILS	92	21280GS	17	2218040GS	24	2513025GS	28	26050T1S	37
13SILICONE	93	20NITRILS3	92	21280S	17	2218040S	24	2513025S	28	26050T75S	37
14EPDME	92	20SILICONE	93	21910GS	23	2218060GS	24	2514020GS	28	26050TS	37
14EPDME3	92	20SSPRESSE	89	21910S	23	2218060S	24	2514020S	28	26060GS	36
14FLUORO	93	20SSPRESSE	89	21912GS	23	24EPDME	92	2514025GS	28	26060S	36
14FLUORO3	94	20SSPRESST	89	21912S	23	24EPDME3	92	2514025S	28	26060T1S	37
14NITRILS	92	21010GS	16	21913GS	23	24FLUORO	93	2514030GS	28	26060T75S	37
14NITRILS3	92	21010S	16	21913S	23	24FLUORO3	94	2514030S	28	26060TS	37
14SILICONE	93	21012GS	16	21914GS	23	24NITRILS	92	2515040GS	29	26080GS	36
15EPDME	92	21012S	16	21914S	23	24NITRILS3	92	2515040S	29	26080S	36
15EPDME3	92	21013GS	16	21915GS	23	2501060GS	27	2516030GS	29	26080T1S	37
15FLUORO	93	21013S	16	21915S	23	2501060S	27	2516030S	29	26080T75S	37
15FLUORO3	94	21015GS	16	21916GS	23	2501080GS	27	2516040GS	29	26080TS	37
15NITRILS	92	21015S	16	21916S	23	2501080S	27	2516040S	29	301103D	20
15NITRILS3	92	21020GS	16	21920GS	23	2501210GS	27	2516050GS	29	301105D	20
15SILICONE	93	21020S	16	21920S	23	2501210S	27	2516050S	29	301106D	20
15SSPRESSE	89	21025GS	16	21925GS	23	2501240GS	27	2520EPDME	95	301123D	20
15SSPRESSE	89	21025S	16	21925S	23	2501240S	27	2520NITRILS	95	301125D	20
15SSPRESST	89	21030GS	16	21930GS	23	2501260GS	27	25EN3	99	301126D	20
1659300	53	21030S	16	21930S	23	2501260S	27	25EPDME	92	301143D	20
16EPDME	92	21040GS	16	21940GS	23	2501280GS	27	25EPDME3	92	301145D	20
16EPDME3	92	21040S	16	21940S	23	2501280S	27	25FLUORO	93	301146D	20
16FLUORO	93	21050GS	16	21950GS	23	2501513GS	27	25FLUORO3	94	301163D	20
16FLUORO3	94	21050S	16	21950S	23	2501513S	27	25NITRILS	92	301165D	20
16NITRILS	92	21060GS	16	21960GS	23	2502513GS	27	25NITRILS3	92	301166D	20
16NITRILS3	92	21060S	16	21960S	23	2502513S	27	25SILICONE	93	301183D	20
16SILICONE	93	21080GS	16	21980GS	23	2502515GS	27	26001GS	36	301185D	20
18EPDME	92	21080S	16	21980S	23	2502515S	27	26001S	36	301186D	20
18EPDME3	92	210L14GS	18	21EPDME	92	2502520GS	27	26010GS	36	301203D	20
18FLUORO	93	210L14S	18	21EPDME3	92	2502520S	27	26010S	36	301205D	20
18FLUORO3	94	210L16GS	18	21FLUORO	93	2503015GS	27	26010T1S	37	301206D	20
18NITRILS	92	210L16S	18	21FLUORO3	94	2503015S	27	26010T75S	37	301213D	20
18NITRILS3	92	21113GS	17	21NITRILS	92	2503020GS	27	26010TS	37	301215D	20
20110GS	16	21113S	17	21NITRILS3	92	2503020S	27	26012GS	36	301216D	20
20110S	16	21115GS	17	2212015GS	24	2503025GS	27	26012S	36	301243D	20

See latest catalog or technical data sheets for specific approvals, listings, and design parameters.  
 POA = Price on availability. Prices subject to change without notice.

**Customer Service: (800) 558-5236**

[www.grinnell.com](http://www.grinnell.com)

# Tyco Mechanical Products

## Section 15 – Indices



Part No. ....	Page	Part No. ....	Page	Part No. ....	Page	Part No. ....	Page	Part No. ....	Page	Part No. ....	Page
301245D	20	303306D	20	310123D	19	311215D	21	312303D	21	3211816GS	25
301246D	20	303403D	20	310125D	19	311216D	21	312305D	21	3211880GS	25
301253D	20	303405D	20	310126D	19	31121S	17	312306D	21	3212114GS	25
301255D	20	303406D	20	310143D	19	311243D	21	312403D	21	3212116GS	25
301256D	20	303503D	20	310145D	19	311245D	21	312405D	21	3212118GS	25
301303D	20	303505D	20	310146D	19	311246D	21	312406D	21	3212414S	25
301305D	20	303506D	20	310163D	19	31124S	17	312503D	21	3212420S	25
301306D	20	303603D	20	310165D	19	311253D	21	312505D	21	3212510GS	24
301403D	20	303605D	20	310166D	19	311255D	21	312506D	21	3214010GS	24
301405D	20	303606D	20	310183D	19	311256D	21	312603D	21	3216050GS	24
301406D	20	303803D	20	310185D	19	311303D	21	312605D	21	3218025GS	24
301503D	20	303805D	20	310186D	19	311305D	21	312606D	21	3231020GS	26
301505D	20	303806D	20	310203D	19	311306D	21	312803D	21	3231030GS	26
301506D	20	306103D	19	310205D	19	311403D	21	312805D	21	3231030S	26
301603D	20	306105D	19	310206D	19	311405D	21	312806D	21	3231040GS	26
301605D	20	306106D	19	310213D	19	311406D	21	31405GS	32	3231040S	26
301606D	20	306123D	19	310215D	19	311503D	21	31410GS	32	3231050GS	26
301803D	20	306125D	19	310216D	19	311505D	21	31412GS	32	3231050S	26
301805D	20	306126D	19	310243D	19	311506D	21	31413GS	32	3231060GS	26
301806D	20	306143D	19	310245D	19	311603D	21	31413S	32	3231060S	26
301L10GS	18	306145D	19	310246D	19	311605D	21	31414GS	32	3231080GS	26
301L12GS	18	306146D	19	310253D	19	311606D	21	31415GS	32	3231080S	26
301L13GS	18	306163D	19	310255D	19	311803D	21	31415S	32	3231210GS	26
301L13S	18	306165D	19	310256D	19	311805D	21	31416GS	32	3231210S	26
301L15GS	18	306166D	19	310303D	19	311806D	21	31416S	32	3231230GS	26
301L15S	18	306183D	19	310305D	19	312103D	21	31418GS	32	3231230S	26
301L18GS	18	306185D	19	310306D	19	312105D	21	31421GS	32	3231240GS	26
301L20GS	18	306186D	19	310403D	19	312106D	21	31424GS	32	3231240S	26
301L21GS	18	306203D	19	310405D	19	31210GS	17	31450S	32	3231250GS	26
301L24GS	18	306205D	19	310406D	19	31210S	17	31513GS	22	3231250S	26
301L25GS	18	306206D	19	310503D	19	312123D	21	31515GS	22	3231260GS	26
301L50GS	18	306213D	19	310505D	19	312125D	21	31540GS	22	3231260S	26
301L80GS	18	306215D	19	310506D	19	312126D	21	31560GS	22	3231280GS	26
3020EPDME	95	306216D	19	310603D	19	31212GS	17	3161208GS	22	3231280S	26
3020NITRILS	95	306243D	19	310605D	19	31212S	17	3161210GS	22	3231513GS	25
3025EPDME	95	306245D	19	310606D	19	312143D	21	31918GS	23	3232013GS	25
3025NITRILS	95	306246D	19	310803D	19	312145D	21	31921GS	23	3234013GS	25
303103D	20	306253D	19	310805D	19	312146D	21	32005	104	3235025GS	25
303105D	20	306255D	19	310806D	19	31214GS	17	32010GS	23	3235030S	25
303106D	20	306256D	19	310L10GS	18	31214S	17	32010S	23	3235040GS	25
303123D	20	306303D	19	310L20GS	18	312163D	21	32012GS	23	3235040S	25
303125D	20	306305D	19	310L25GS	18	312165D	21	32012S	23	3236050GS	26
303126D	20	306306D	19	310LR13GS	18	312166D	21	32013GS	23	3238030GS	26
303143D	20	306403D	19	310LR15GS	18	31216GS	17	32013S	23	3238040GS	26
303145D	20	306405D	19	310LR18GS	18	31216S	17	32015GS	23	3238040S	26
303146D	20	306406D	19	310LR21GS	18	312183D	21	32020GS	23	3238050GS	26
303163D	20	306503D	19	311103D	21	312185D	21	32025GS	23	3238050S	26
303165D	20	306505D	19	311105D	21	312186D	21	32030GS	23	3238060GS	26
303166D	20	306506D	19	311106D	21	31218GS	17	32037	104	3238060S	26
303183D	20	306603D	19	311123D	21	31218S	17	32038	104	32414GS	34
303185D	20	306605D	19	311125D	21	312203D	21	32040GS	23	32416GS	34
303186D	20	306606D	19	311126D	21	312205D	21	32050GS	23	32418GS	34
303203D	20	306803D	19	311143D	21	312206D	21	32050S	23	32421GS	34
303205D	20	306805D	19	311145D	21	312213D	21	32060GS	23	32424GS	34
303206D	20	306806D	19	311146D	21	312215D	21	32080GS	23	32425GS	34
303213D	20	30EN3	99	311163D	21	312216D	21	32080S	23	32450GS	34
303215D	20	30EPDME	92	311165D	21	31221GS	17	3211005GS	24	32480GS	34
303216D	20	30EPDME3	92	311166D	21	31221S	17	3211205GS	24	3251410GS	33
303243D	20	30FLUORO	93	311183D	21	312243D	21	3211230GS	24	3251412GS	33
303245D	20	30FLUORO3	94	311185D	21	312245D	21	3211410GS	24	3251460GS	33
303246D	20	30NITRILS	92	311186D	21	312246D	21	3211460GS	24	3251480GS	33
303253D	20	30NITRILS3	92	31118S	17	31224GS	17	3211610GS	25	3251610GS	33
303255D	20	30SILICONE	93	311203D	21	31224S	17	3211614GS	25	3251612GS	33
303256D	20	310103D	19	311205D	21	312253D	21	3211810GS	25	3251614GS	33
303303D	20	310105D	19	311206D	21	312255D	21	3211812GS	25	3251660GS	33
303305D	20	310106D	19	311213D	21	312256D	21	3211814GS	25	3251680GS	33

Customer Service: (800) 558-5236

See latest catalog or technical data sheets for specific approvals, listings, and design parameters.

POA = Price on availability. Prices subject to change without notice.

Part No. ....	Page	Part No. ....	Page	Part No. ....	Page	Part No. ....	Page	Part No. ....	Page	Part No. ....	Page
3251814GS	33	34214S	38	3512510S	28	401016A40	71	401406AD40	71	4070500	83
3251816GS	33	34215GS	38	3512513GS	28	401016AD	66	401504A	66	407050T	83
3251860GS	33	34215S	38	3512515GS	28	401016AD40	71	401504AD	66	407075E	83
3251880GS	33	34216GS	38	3513010GS	28	401104A	66	401506A	66	407075O	83
3252112GS	33	34216S	38	3513010S	28	401104A40	71	401506AD	66	407075T	83
3252114GS	33	34218GS	38	3513013GS	28	401104AD	66	401604A	66	407100E	83
3252116GS	33	34218S	38	3513015GS	28	401104AD40	71	401604A40	71	407100O	83
3252421GS	33	34220S	38	3514010GS	28	401106A	66	401604AD	66	407100T	83
3253020GS	33	34221GS	38	3514010S	28	401106A40	71	401604AD40	71	407150E	83
3254030GS	33	34221S	38	3514013GS	28	401106AD	66	401606A	66	407150O	83
3255025S	33	34224GS	38	3514015GS	28	401106AD40	71	401606A40	71	407150T	83
3256025GS	33	34224S	38	3515030GS	29	401124A	66	401606AD	66	407200E	83
3256025S	33	34225GS	38	3516025GS	29	401124A40	71	401606AD40	71	407200O	83
32713GS	36	34230GS	38	3518030GS	29	401124AD	66	401804A	66	407200T	83
32713S	36	34240GS	38	3518040GS	29	401124AD40	71	401804A40	71	408050E	83
32714GS	36	34280GS	38	3518050GS	29	401126A	66	401804AD	66	408050O	83
32714S	36	3501050GS	27	3518060GS	29	401126A40	71	401804AD40	71	408050T	83
32715GS	36	3501301GS	27	3722013GS	30	401126AD	66	401806A	66	408075E	83
32716S	36	3501301S	27	3722513GS	30	401126AD40	71	401806A40	71	408075O	83
32718GS	36	3501460GS	28	3722515GS	30	401134A	66	401806AD	66	408075T	83
32718S	36	3501480GS	28	3723013GS	30	401134A40	71	401806AD40	71	408100E	83
32721GS	36	3501610GS	28	3724013GS	30	401134AD	66	4020EPDME	95	408100O	83
32721S	36	3501614GS	28	3725030GS	30	401134AD40	71	4020NITRILS	95	408100T	83
32724GS	36	3501680GS	28	3725030S	30	401136A	66	4025EPDME	95	408150E	83
32724S	36	3501812GS	28	3725040GS	30	401136A40	71	4025NITRILS	95	408150O	83
32750GS	36	3501814GS	28	3725040S	30	401136AD	66	4030EPDME	95	408150T	83
3301010GS	35	3501816GS	28	3726040GS	30	401136AD40	71	4030NITRILS	95	408200E	83
3301030GS	35	3502112GS	28	373828	29	401154A	66	40501EN	65	408200O	83
3301030S	35	3502114GS	28	3913060GS	30	401154A40	71	40501T	65	408200T	83
3301040S	35	3502116GS	28	3915060GS	30	401154AD	66	40513EN	65	40EN3	99
3301212GS	35	3502118GS	28	3916060GS	30	401154AD40	71	40513EN3	65	40EPDME	92
3301230GS	35	3502418GS	28	3921080GS	31	401156A	66	40513T	65	40EPDME3	92
3301260GS	35	3502421GS	28	3921280GS	31	401156A40	71	40513T3	65	40FLUORO	93
3301260S	35	3504013GS	27	3921540GS	31	401156AD	66	40515EN	65	40FLUORO3	94
3301280GS	35	3505025GS	29	3922040GS	31	401156AD40	71	40515EN3	65	40NITRILS	92
3301280S	35	3511040GS	29	3922540GS	31	401204A	66	40515T	65	40NITRILS3	92
33020GS	35	3511050GS	29	3923040GS	31	401204A40	71	40515T3	65	40SILICONE	93
3302525GS	35	3511050S	29	3925060GS	31	401204AD	66	40520EN	65	410014A	66
3305030GS	35	3511060GS	29	3928060GS	31	401204AD40	71	40520EN3	65	410014A40	71
3305030S	35	3511210GS	29	3931080GS	31	401206A	66	40520T	65	410014AD	66
3305040S	35	3511240GS	29	3931280GS	31	401206A40	71	40520T3	65	410014AD40	71
3305050GS	35	3511240S	29	3931340GS	31	401206AD	66	40525EN	65	410016A	66
3306030GS	35	3511250GS	29	3931540GS	31	401206AD40	71	40525EN3	65	410016A40	71
3306030S	35	3511250S	29	3931540S	31	401254A	66	40525T	65	410016AD	66
3306040S	35	3511410GS	29	3932040GS	31	401254A40	71	40525T3	65	410016AD40	71
3308030S	35	3511460GS	29	3932540GS	31	401254AD	66	40530EN	65	410104A	66
3308040S	35	3511460S	29	3935060GS	31	401254AD40	71	40530EN3	65	410104A40	71
3308050GS	35	3511480GS	29	3936060GS	31	401256A	66	40530T	65	410104AD	66
3308050S	35	3511510GS	28	3938060GS	31	401256A40	71	40530T3	65	410104AD40	71
3308060S	35	3511510S	28	3951014S	31	401256AD	66	40540EN	65	410106A	66
3314030GS	34	3511513GS	28	39580125GS	31	401256AD40	71	40540EN3	65	410106A40	71
3314030S	34	3511612GS	29	39580125S	31	401304A	66	40540T	65	410106AD	66
331503050GS	34	3511680S	29	3975015S	39	401304A40	71	40540T3	65	410106AD40	71
3315030GS	34	3511814GS	29	3975025S	39	401304AD	66	40550EN	65	410124A	66
3315030S	34	3511816GS	29	3978060S	39	401304AD40	71	40550EN3	65	410124A40	71
34114GS	38	3512010GS	28	3985015S	40	401306A	66	40550T	65	410124AD	66
34115GS	38	3512015GS	28	3985025S	40	401306A40	71	40550T3	65	410124AD40	71
34116GS	38	3512112S	29	3988060S	40	401306AD	66	40560EN	65	410126A	66
34118GS	38	3512116GS	29	3995015S	41	401306AD40	71	40560EN3	65	410126A40	71
34120GS	38	3512118GS	29	3995025S	41	401404A	66	40560T	65	410126AD	66
34121GS	38	3512410GS	29	3998060S	41	401404A40	71	40560T3	65	410126AD40	71
34210GS	38	3512410S	29	401014A	66	401404AD	66	40580EN	65	41013	105
34210S	38	3512418GS	29	401014A40	71	401404AD40	71	40580EN3	65	410134A	66
34212GS	38	3512421GS	29	401014AD	66	401406A	66	40580T	65	410134A40	71
34212S	38	3512421S	29	401014AD40	71	401406A40	71	40580T3	65	410134AD	66
34214GS	38	3512510GS	28	401016A	66	401406AD	66	407050E	83	410134AD40	71

See latest catalog or technical data sheets for specific approvals, listings, and design parameters.  
 POA = Price on availability. Prices subject to change without notice.

**Customer Service: (800) 558-5236**

**www.grinnell.com**



# Tyco Mechanical Products

## Section 15 – Indices



Part No. ....	Page	Part No. ....	Page	Part No. ....	Page	Part No. ....	Page	Part No. ....	Page	Part No. ....	Page
410136A	66	410604A	66	41458	63	419154A	67	42110606AD	68	42125014AD	68
410136A40	71	410604A40	71	41459	63	419154A40	72	42110606AD40	72	42125016A	68
410136AD	66	410604AD	66	41460	63	419154AD	67	42110804A	68	42125016AD	68
410136AD40	71	410604AD40	71	41461	63	419154AD40	72	42110804A40	72	42125104A	68
41014	105	410606A	66	41462	63	419156A	67	42110804AD	68	42125104A40	72
41015	105	410606A40	71	41464	63	419156A40	72	42110804AD40	72	42125104AD40	72
410154A	66	410606AD	66	41465	62	419156AD	67	42110806A	68	42125106A40	72
410154A40	71	410606AD40	71	41466	62	419156AD40	72	42110806A40	72	42125106AD40	72
410154AD	66	410804A	66	41467	62	419204A	67	42110806AD	68	42125154A	68
410154AD40	71	410804A40	71	41468	62	419204A40	72	42110806AD40	72	42125154AD	68
410156A	66	410804AD	66	41469	62	419204AD	67	42112104A	68	42125154AD40	72
410156A40	71	410804AD40	71	41470	62	419204AD40	72	42112104A40	72	42125154AD40	72
410156AD	66	410806A	66	41472	62	419206A	67	42112104AD	68	42125156A	68
410156AD40	71	410806A40	71	41474	62	419206A40	72	42112104AD40	72	42125156A40	72
41017	105	410806AD	66	41475	62	419206AD	67	42112106A	68	42125156AD	68
41018	105	410806AD40	71	41476	62	419206AD40	72	42112106A40	72	42125156AD40	72
410204A	66	41210	105	41477	62	419254A	67	42112106AD	68	42125204A	68
410204A40	71	41250	105	41478	62	419254A40	72	42112106AD40	72	42125204A40	72
410204AD	66	41251	105	41480	62	419254AD	67	42112804A	68	42125204AD	68
410204AD40	71	41252	105	41500	106	419254AD40	72	42112804A40	72	42125204AD40	72
410206A	66	41257	105	41501	106	419256A	67	42112804AD	68	42125206A	68
410206A40	71	41258	105	41502	106	419256A40	72	42112804AD40	72	42125206A40	72
410206AD	66	41259	105	41503	106	419256AD	67	42112806A	68	42125206AD	68
410206AD40	71	41260	105	41504	106	419256AD40	72	42112806A40	72	42125206AD40	72
410254A	66	41261	105	41505	106	419304A	67	42112806AD	68	42130014A	68
410254A40	71	41262	106	41506	106	419304A40	72	42112806AD40	72	42130014A40	72
410254AD	66	41263	106	41507	106	419304AD	67	42115014A	68	42130014AD	68
410254AD40	71	41264	106	41508	106	419304AD40	72	42115014A40	72	42130014AD40	72
410256A	66	41265	106	41509	106	419306A	67	42115014AD	68	42130016A	68
410256A40	71	41266	106	41510	106	419306A40	72	42115014AD40	72	42130016A40	72
410256AD	66	41267	106	41511	106	419306AD	67	42115016A	68	42130016AD	68
410256AD40	71	41268	106	41512	105	419306AD40	72	42115016A40	72	42130016AD40	72
41027	105	41269	106	41513	106	419404A	67	42115016AD	68	42130134A	68
41029	105	41270	106	41514	106	419404A40	72	42115016AD40	72	42130134A40	72
410304A	66	41271	106	419014A	67	419404AD	67	42115134A	68	42130134AD	68
410304A40	71	41272	106	419014A40	72	419404AD40	72	42115134A40	72	42130134AD40	72
410304AD	66	41273	106	419014AD	67	419406A	67	42115134AD	68	42130136A	68
410304AD40	71	41274	106	419014AD40	72	419406A40	72	42115134AD40	72	42130136A40	72
410306A	66	41275	106	419016A	67	419406AD	67	42115136A	68	42130136AD	68
410306A40	71	41276	106	419016A40	72	419406AD40	72	42115136A40	72	42130136AD40	72
410306AD	66	41277	106	419016AD	67	419504A	67	42115136AD	68	42130154A	68
410306AD40	71	41278	106	419016AD40	72	419504AD	67	42115136AD40	72	42130154A40	72
41032	105	41279	106	419104A	67	419506A	67	42120014AD	68	42130154AD	68
41033	105	41280	106	419104A40	72	419506AD	67	42120016A	68	42130154AD40	72
41034	105	41281	106	419104AD	67	419604A	67	42120016AD	68	42130156A	68
41035	105	41282	106	419104AD40	72	419604A40	72	42120104A	68	42130156A40	72
41037	105	41283	106	419106A	67	419604AD	67	42120104A40	72	42130156AD	68
41038	105	41284	106	419106A40	72	419604AD40	72	42120104AD40	72	42130156AD40	72
41039	105	41285	106	419106AD	67	419606A	67	42120106A40	72	42130204A	68
41040	105	41286	106	419106AD40	72	419606A40	72	42120106AD40	72	42130204A40	72
410404A	66	41287	106	419124A	67	419606AD	67	42120134A	68	42130204AD	68
410404A40	71	41288	106	419124A40	72	419606AD40	72	42120134A40	72	42130204AD40	72
410404AD	66	41289	106	419124AD	67	419804A	67	42120134AD	68	42130206A	68
410404AD40	71	41290	106	419124AD40	72	419804A40	72	42120134AD40	72	42130206A40	72
410406A	66	41291	106	419126A	67	419804AD	67	42120136A	68	42130206AD	68
410406A40	71	41292	106	419126A40	72	419804AD40	72	42120136A40	72	42130206AD40	72
410406AD	66	41293	106	419126AD	67	419806A	67	42120136AD	68	42130254A	68
410406AD40	71	41294	106	419126AD40	72	419806A40	72	42120136AD40	72	42130254A40	72
41041	105	41295	106	419134A	67	419806AD	67	42120154A	68	42130254AD	68
41047	63, 105	41296	106	419134A40	72	419806AD40	72	42120154A40	72	42130254AD40	72
41048	105	41297	106	419134AD	67	42110604A	68	42120154AD	68	42130256A	68
41049	105	41298	106	419134AD40	72	42110604A40	72	42120154AD40	72	42130256A40	72
410504A	66	41299	106	419136A	67	42110604AD	68	42120156A	68	42130256AD	68
410504AD	66	41455	63	419136A40	72	42110604AD40	72	42120156A40	72	42130256AD40	72
410506A	66	41456	63	419136AD	67	42110606A	68	42120156AD	68	42140204A	68
410506AD	66	41457	63	419136AD40	72	42110606A40	72	42120156AD40	72	42140204A40	72

Introduction
Couplings & Fittings
Mechanical Tees
Valves
Circuit Balancing Valves
Accessories
Copper Systems
Stainless Steel Systems
Plain End Systems
Stainless Steel G-PRESS
HDPE Systems
Gaskets & Spare Parts
Preparation Equipment
Miscellaneous
Indices

Customer Service: (800) 558-5236

See latest catalog or technical data sheets for specific approvals, listings, and design parameters.

POA = Price on availability. Prices subject to change without notice.

Part No. ....	Page	Part No. ....	Page	Part No. ....	Page	Part No. ....	Page	Part No. ....	Page	Part No. ....	Page
42140204AD ...	68	42180606A ...	68	45012604AD40 ...	73	45025206A40 ...	73	45040306AD40 ...	73	45080404AD40 ...	73
42140204AD40 ...	72	42180606A40 ...	72	45012606A ...	69	45025206AD ...	69	45050304A ...	69	45080406A ...	69
42140206A ...	68	42180606AD ...	68	45012606A40 ...	73	45025206AD40 ...	73	45050304A40 ...	73	45080406A40 ...	73
42140206A40 ...	72	42180606AD40 ...	72	45012606AD ...	69	45030014A ...	69	45050304AD ...	69	45080406AD ...	69
42140206AD ...	68	441204 ...	68	45012606AD40 ...	73	45030014A40 ...	73	45050304AD40 ...	73	45080406AD40 ...	73
42140206AD40 ...	72	441206 ...	68	45012804A ...	69	45030014AD ...	69	45050306A ...	69	45080604A ...	69
42140254A ...	68	441254 ...	68	45012804A40 ...	73	45030014AD40 ...	73	45050306A40 ...	73	45080604A40 ...	73
42140254A40 ...	72	441256 ...	68	45012804AD ...	69	45030016A ...	69	45050306AD ...	69	45080604AD ...	69
42140254AD ...	68	441304 ...	68	45012804AD40 ...	73	45030016A40 ...	73	45050306AD40 ...	73	45080604AD40 ...	73
42140254AD40 ...	72	441306 ...	68	45012806A ...	69	45030016AD ...	69	45050404A ...	69	45080606A ...	69
42140256A ...	68	441404 ...	68	45012806A40 ...	73	45030016AD40 ...	73	45050404A40 ...	73	45080606A40 ...	73
42140256A40 ...	72	441406 ...	68	45012806AD ...	69	45030134A ...	69	45050404AD ...	69	45080606AD ...	69
42140256AD ...	68	441604 ...	68	45012806AD40 ...	73	45030134A40 ...	73	45050404AD40 ...	73	45080606AD40 ...	73
42140256AD40 ...	72	441606 ...	68	45015014A ...	69	45030134AD ...	69	45050406A ...	69	45110604A ...	70
42140304A ...	68	441804 ...	68	45015014A40 ...	73	45030136AD ...	69	45050406A40 ...	73	45110604A40 ...	74
42140304A40 ...	72	441806 ...	68	45015014AD ...	69	45030136A40 ...	69	45050406AD ...	69	45110604AD ...	70
42140304AD ...	68	442050E ...	85	45015014AD40 ...	73	45030136AD40 ...	73	45050406AD40 ...	73	45110604AD40 ...	74
42140304AD40 ...	72	442050O ...	85	45015016A ...	69	45030136AD ...	69	45060204A ...	69	45110606A ...	70
42140306A ...	68	442050T ...	85	45015016A40 ...	73	45030136AD40 ...	73	45060204A40 ...	73	45110606A40 ...	74
42140306A40 ...	72	442075E ...	85	45015016AD ...	69	45030154A ...	69	45060204AD ...	69	45110606AD ...	70
42140306AD ...	68	442075O ...	85	45015016AD40 ...	73	45030154A40 ...	73	45060204AD40 ...	73	45110606AD40 ...	74
42140306AD40 ...	72	442075T ...	85	45015134A ...	69	45030154AD ...	69	45060206A ...	69	45110804A ...	70
42160154A ...	68	442100E ...	85	45015134A40 ...	73	45030154AD40 ...	73	45060206A40 ...	73	45110804A40 ...	74
42160154A40 ...	72	442100O ...	85	45015134AD ...	69	45030156A ...	69	45060206AD ...	69	45110804AD ...	70
42160154AD ...	68	442100T ...	85	45015134AD40 ...	73	45030156A40 ...	73	45060206AD40 ...	73	45110804AD40 ...	74
42160154AD40 ...	72	442150E ...	85	45015136A ...	69	45030156AD ...	69	45060254A ...	69	45110806A ...	70
42160156A ...	68	442150O ...	85	45015136A40 ...	73	45030156AD40 ...	73	45060254A40 ...	73	45110806A40 ...	74
42160156A40 ...	72	442150T ...	85	45015136AD ...	69	45030204A ...	69	45060254AD ...	69	45110806AD ...	70
42160156AD ...	68	442200E ...	85	45015136AD40 ...	73	45030204A40 ...	73	45060254AD40 ...	73	45110806AD40 ...	74
42160156AD40 ...	72	442200O ...	85	45020014AD ...	69	45030204AD ...	69	45060256A ...	69	45112104A ...	70
42160204A ...	68	442200T ...	85	45020016A ...	69	45030204AD40 ...	73	45060256A40 ...	73	45112104A40 ...	74
42160204A40 ...	72	45010404A ...	69	45020016AD ...	69	45030206A ...	69	45060256AD ...	69	45112104AD ...	70
42160204AD ...	68	45010404A40 ...	73	45020104A ...	69	45030206A40 ...	73	45060256AD40 ...	73	45112104AD40 ...	74
42160204AD40 ...	72	45010404AD ...	69	45020104A40 ...	73	45030206AD ...	69	45060304A ...	69	45112106A ...	70
42160206A ...	68	45010404AD40 ...	73	45020104AD40 ...	73	45030206AD40 ...	73	45060304A40 ...	73	45112106A40 ...	74
42160206A40 ...	72	45010406A ...	69	45020106A40 ...	73	45030254A ...	69	45060304AD ...	69	45112106AD ...	70
42160206AD ...	68	45010406A40 ...	73	45020106AD40 ...	73	45030254A40 ...	73	45060304AD40 ...	73	45112106AD40 ...	74
42160206AD40 ...	72	45010406AD ...	69	45020134A ...	69	45030254AD ...	69	45060306A ...	69	45112604A ...	70
42160304A ...	68	45010406AD40 ...	73	45020134A40 ...	73	45030254AD40 ...	73	45060306A40 ...	73	45112604A40 ...	74
42160304A40 ...	72	45010604A ...	69	45020134AD ...	69	45030256A ...	69	45060306AD ...	69	45112604AD ...	70
42160304AD ...	68	45010604A40 ...	73	45020134AD40 ...	73	45030256A40 ...	73	45060306AD40 ...	73	45112604AD40 ...	74
42160304AD40 ...	72	45010604AD ...	69	45020136A ...	69	45030256AD ...	69	45060404A ...	69	45112606A ...	70
42160306A ...	68	45010604AD40 ...	73	45020136A40 ...	73	45030256AD40 ...	73	45060404A40 ...	73	45112606A40 ...	74
42160306A40 ...	72	45010606A ...	69	45020136AD ...	69	45040204A ...	69	45060404AD ...	69	45112606AD ...	70
42160306AD ...	68	45010606A40 ...	73	45020136AD40 ...	73	45040204A40 ...	73	45060404AD40 ...	73	45112606AD40 ...	74
42160306AD40 ...	72	45010606AD ...	69	45020154A ...	69	45040204AD ...	69	45060406A ...	69	45112804A ...	70
42160404A ...	68	45010606AD40 ...	73	45020154A40 ...	73	45040204AD40 ...	73	45060406A40 ...	73	45112804A40 ...	74
42160404A40 ...	72	45010804A ...	69	45020154AD ...	69	45040206A ...	69	45060406AD ...	69	45112804AD ...	70
42160404AD ...	68	45010804A40 ...	73	45020154AD40 ...	73	45040206A40 ...	73	45060406AD40 ...	73	45112804AD40 ...	74
42160404AD40 ...	72	45010804AD ...	69	45020156A ...	69	45040206AD ...	69	45060504A ...	69	45112806A ...	70
42160406A ...	68	45010804AD40 ...	73	45020156A40 ...	73	45040206AD40 ...	73	45060504A40 ...	73	45112806A40 ...	74
42160406A40 ...	72	45010806A ...	69	45020156AD ...	69	45040254A ...	69	45060504AD ...	69	45112806AD ...	70
42160406AD ...	68	45010806A40 ...	73	45020156AD40 ...	73	45040254A40 ...	73	45060504AD40 ...	73	45112806AD40 ...	74
42160406AD40 ...	72	45010806AD ...	69	45025154A ...	69	45040254AD ...	69	45060506A40 ...	73	45113014A ...	70
42180404A ...	68	45010806AD40 ...	73	45025154A40 ...	73	45040254AD40 ...	73	45060506AD40 ...	73	45113014A40 ...	74
42180404A40 ...	72	45012104A ...	69	45025154AD ...	69	45040256A ...	69	45080304A ...	69	45113014AD ...	70
42180404AD ...	68	45012104A40 ...	73	45025154AD40 ...	73	45040256A40 ...	73	45080304A40 ...	73	45113014AD40 ...	74
42180404AD40 ...	72	45012104AD ...	69	45025156A ...	69	45040256AD ...	69	45080304AD ...	69	45113016A ...	70
42180406A ...	68	45012104AD40 ...	73	45025156A40 ...	73	45040256AD40 ...	73	45080304AD40 ...	73	45113016A40 ...	74
42180406A40 ...	72	45012106A ...	69	45025156AD ...	69	45040304A ...	69	45080306A ...	69	45113016AD ...	70
42180406AD ...	68	45012106A40 ...	73	45025156AD40 ...	73	45040304A40 ...	73	45080306A40 ...	73	45113016AD40 ...	74
42180406AD40 ...	72	45012106AD ...	69	45025204A ...	69	45040304AD ...	69	45080306AD ...	69	45115014A ...	70
42180604A ...	68	45012106AD40 ...	73	45025204A40 ...	73	45040304AD40 ...	73	45080306AD40 ...	73	45115014A40 ...	74
42180604A40 ...	72	45012604A ...	69	45025204AD ...	69	45040306A ...	69	45080404A ...	69	45115014AD ...	70
42180604AD ...	68	45012604A40 ...	73	45025204AD40 ...	73	45040306A40 ...	73	45080404A40 ...	73	45115014AD40 ...	74
42180604AD40 ...	72	45012604AD ...	69	45025206A ...	69	45040306AD ...	69	45080404AD ...	69	45115016A ...	70

See latest catalog or technical data sheets for specific approvals, listings, and design parameters.  
POA = Price on availability. Prices subject to change without notice.

**Customer Service: (800) 558-5236**

# Tyco Mechanical Products

## Section 15 – Indices



Part No. ....	Page	Part No. ....	Page	Part No. ....	Page	Part No. ....	Page	Part No. ....	Page	Part No. ....	Page
45115016A40	74	45130256AD40	74	45160404A40	74	460406AD	67	468100T	83	47215T	64
45115016AD	70	45140204A	70	45160404AD	70	460504A	67	468150E	83	47215T3	64
45115016AD40	74	45140204A40	74	45160404AD40	74	460504AD	67	468150O	83	47220EN	64
45115134A	70	45140204AD	70	45160406A	70	460506A	67	468150T	83	47220EN3	64
45115134A40	74	45140204AD40	74	45160406A40	74	460506AD	67	468200E	83	47220T	64
45115134AD	70	45140206A	70	45160406AD	70	460604A	67	468200O	83	47220T3	64
45115134AD40	74	45140206A40	74	45160406AD40	74	460604AD	67	468200T	83	47225EN	64
45115136A	70	45140206AD	70	45180304A	70	460606A	67	469050E	89	47225EN3	64
45115136A40	74	45140206AD40	74	45180304A40	74	460606AD	67	469050O	89	47225T	64
45115136AD	70	45140254A	70	45180304AD	70	460804A	67	469050T	89	47225T3	64
45115136AD40	74	45140254A40	74	45180304AD40	74	460804AD	67	469075E	89	47230EN	64
45120014A	70	45140254AD	70	45180306A	70	460806A	67	469075O	89	47230EN3	64
45120014A40	74	45140254AD40	74	45180306A40	74	460806AD	67	469075T	89	47230T	64
45120014AD	70	45140256A	70	45180306AD	70	461050E	88	469100E	89	47230T3	64
45120014AD40	74	45140256A40	74	45180306AD40	74	461050O	88	469100O	89	47240EN	64
45120016A	70	45140256AD	70	45180404A	70	461050T	88	469100T	89	47240EN3	64
45120016A40	74	45140256AD40	74	45180404A40	74	461075E	88	469150E	89	47240T	64
45120016AD	70	45140304A	70	45180404AD	70	461075O	88	469150O	89	47240T3	64
45120016AD40	74	45140304A40	74	45180404AD40	74	461075T	88	469150T	89	47250EN	64
45120134A	70	45140304AD	70	45180406A	70	461100E	88	469200E	89	47250EN3	64
45120134A40	74	45140304AD40	74	45180406A40	74	461100O	88	469200O	89	47250T	64
45120134AD	70	45140306A	70	45180406AD	70	461100T	88	469200T	89	47250T3	64
45120134AD40	74	45140306A40	74	45180406AD40	74	461150E	88	470050E	84	47260EN	64
45120136A	70	45140306AD	70	45180604A	70	461150O	88	470050O	84	47260EN3	64
45120136A40	74	45140306AD40	74	45180604A40	74	461150T	88	470050T	84	47260T	64
45120136AD	70	45150304A	70	45180604AD	70	461200E	88	470075E	84	47260T3	64
45120136AD40	74	45150304A40	74	45180604AD40	74	461200O	88	470075O	84	47280EN	64
45120154A	70	45150304AD	70	45180606A	70	461200T	88	470075T	84	47280EN3	64
45120154A40	74	45150304AD40	74	45180606A40	74	466050E	89	470100E	84	47280T	64
45120154AD	70	45150306A	70	45180606AD	70	466050O	89	470100O	84	47280T3	64
45120154AD40	74	45150306A40	74	45180606AD40	74	466050T	89	470100T	84	4731005E	85
45120156A	70	45150306AD	70	460014A	67	466075E	89	470150E	84	4731005O	85
45120156A40	74	45150306AD40	74	460014AD	67	466075O	89	470150O	84	4731005T	85
45120156AD	70	45150404A	70	460016A	67	466075T	89	470150T	84	4731075E	85
45120156AD40	74	45150404A40	74	460016AD	67	466100E	89	470200E	84	4731075O	85
45125204A	70	45150404AD	70	460104A	67	466100O	89	470200O	84	4731075T	85
45125204A40	74	45150404AD40	74	460104AD	67	466100T	89	470200T	84	4731505E	85
45125204AD	70	45150406A	70	460106A	67	466150E	89	471050E	84	4731505O	85
45125204AD40	74	45150406A40	74	460106AD	67	466150O	89	471050O	84	4731505T	85
45125206A	70	45150406AD	70	460124A	67	466150T	89	471050T	84	4731510E	85
45125206A40	74	45150406AD40	74	460124AD	67	466200E	89	471075E	84	4731510O	85
45125206AD	70	45160204A	70	460126A	67	466200O	89	471075O	84	4731510T	85
45125206AD40	74	45160204A40	74	460126AD	67	466200T	89	471075T	84	4731575E	85
45130014A	70	45160204AD	70	460134A	67	467050E	84	471100E	84	4731575O	85
45130014A40	74	45160204AD40	74	460134AD	67	467050O	84	471100O	84	4731575T	85
45130014AD	70	45160206A	70	460136A	67	467050T	84	471100T	84	4732005E	85
45130014AD40	74	45160206A40	74	460136AD	67	467075E	84	471150E	84	4732005O	85
45130016A	70	45160206AD	70	460154A	67	467075O	84	471150O	84	4732005T	85
45130016A40	74	45160206AD40	74	460154AD	67	467075T	84	471150T	84	4732010E	85
45130016AD	70	45160254A	70	460156A	67	467100E	84	471200E	84	4732010O	85
45130016AD40	74	45160254A40	74	460156AD	67	467100O	84	471200O	84	4732010T	85
45130204A	70	45160254AD	70	460204A	67	467100T	84	471200T	84	4732015E	85
45130204A40	74	45160254AD40	74	460204AD	67	467150E	84	47210EN	64	4732015O	85
45130204AD	70	45160256A	70	460206A	67	467150O	84	47210EN3	64	4732015T	85
45130204AD40	74	45160256A40	74	460206AD	67	467150T	84	47210T	64	4732075E	85
45130206A	70	45160256AD	70	460254A	67	467200E	84	47210T3	64	4732075O	85
45130206A40	74	45160256AD40	74	460254AD	67	467200O	84	47212EN	64	4732075T	85
45130206AD	70	45160304A	70	460256A	67	467200T	84	47212EN3	64	4737505E	85
45130206AD40	74	45160304A40	74	460256AD	67	468050E	83	47212T	64	4737505O	85
45130254A	70	45160304AD	70	460304A	67	468050O	83	47212T3	64	4737505T	85
45130254A40	74	45160304AD40	74	460304AD	67	468050T	83	47213EN	64	4741005E	86
45130254AD	70	45160306A	70	460306A	67	468075E	83	47213EN3	64	4741005O	86
45130254AD40	74	45160306A40	74	460306AD	67	468075O	83	47213T	64	4741005T	86
45130256A	70	45160306AD	70	460404A	67	468075T	83	47213T3	64	4741075E	86
45130256A40	74	45160306AD40	74	460404AD	67	468100E	83	47215EN	64	4741075O	86
45130256AD	70	45160404A	70	460406A	67	468100O	83	47215EN3	64	4741075T	86

Customer Service: (800) 558-5236

See latest catalog or technical data sheets for specific approvals, listings, and design parameters.

POA = Price on availability. Prices subject to change without notice.

Introduction  
Couplings & Fittings  
Mechanical Tees  
Valves  
Circuit Balancing Valves  
Accessories  
Copper Systems  
Stainless Steel Systems  
Plain End Systems  
Stainless Steel G-PRESS  
HDPE Systems  
Gaskets & Spare Parts  
Preparation Equipment  
Miscellaneous  
Indices

Part No. ....	Page	Part No. ....	Page	Part No. ....	Page	Part No. ....	Page	Part No. ....	Page	Part No. ....	Page
4741505E.....	86	4761515E.....	87	4782020T.....	86	4797512T.....	87	50FLUORO3 ...	94	6162520NSF ...	99
4741505O.....	86	4761515O.....	87	4782075E.....	86	4797575E.....	87	50NITRILS.....	92	6163020ENP ...	58
4741505T.....	86	4761515T.....	87	4782075O.....	86	4797575O.....	87	50NITRILS3 ...	92	6163020NSF ...	99
4741510E.....	86	4761575E.....	87	4782075T.....	86	4797575T.....	87	50SILICONE ...	93	6163025ENP ...	58
4741510O.....	86	4761575O.....	87	4787505E.....	86	484050E.....	88	590300100 ...	51	6163025NSF ...	99
4741510T.....	86	4761575T.....	87	4787505O.....	86	484050O.....	88	590300100P...	51	6164025ENP ...	58
4741575E.....	86	4762015E.....	87	4787505T.....	86	484050T.....	88	590300100TP...	51	6164025NSF ...	99
4741575O.....	86	4762015O.....	87	4787510E.....	86	484075E.....	88	590300120P...	51	6164030ENP ...	58
4741575T.....	86	4762015T.....	87	4787510O.....	86	484075O.....	88	590300120TP...	51	6164030NSF ...	99
4742005E.....	86	4762020E.....	87	4787510T.....	86	484075T.....	88	59030020 ...	51	6165040ENP ...	58
4742005O.....	86	4762020O.....	87	4787510T.....	86	484100E.....	88	59030020P...	51	6165040NSF ...	99
4742005T.....	86	4762020T.....	87	4787575E.....	86	484100O.....	88	59030020T...	51	6166040ENP ...	58
4742010E.....	86	4767505E.....	87	4787575O.....	86	484100T.....	88	59030020TP...	51	6166040NSF ...	99
4742010O.....	86	4767505O.....	87	4787575T.....	86	484150E.....	88	59030025 ...	51	61720ENP.....	59
4742010T.....	86	4767505T.....	87	4790505E.....	87	484150O.....	88	59030025P...	51	61720NSF.....	100
4742015E.....	86	4767510E.....	87	4790505O.....	87	484150T.....	88	59030025TP...	51	61725ENP.....	59
4742015O.....	86	4767510O.....	87	4790505T.....	87	484200E.....	88	59030030 ...	51	61725NSF.....	100
4742015T.....	86	4767510T.....	87	4790510E.....	87	484200O.....	88	59030030P...	51	61730ENP.....	59
4742075E.....	86	4767512E.....	87	4790510O.....	87	484200T.....	88	59030030TP...	51	61730NSF.....	100
4742075O.....	86	4767512O.....	87	4790510T.....	87	485050E.....	88	59030040 ...	51	61740ENP.....	59
4742075T.....	86	4767512T.....	87	4790575E.....	87	485050O.....	88	59030040P...	51	61740NSF.....	100
4747505E.....	86	4767575E.....	87	4790575O.....	87	485050T.....	88	59030040T...	51	61820075...	62
4747505O.....	86	4767575O.....	87	4790575T.....	87	485075E.....	88	59030040TP...	51	6182010...	62
4747505T.....	86	4767575T.....	87	4791005E.....	87	485075O.....	88	59030050 ...	51	6182013...	62
475050E.....	89	477075.....	88	4791005O.....	87	485075T.....	88	59030050P...	51	6182015...	62
475050O.....	89	477100.....	88	4791010E.....	87	485100E.....	88	59030050TP...	51	61825075...	62
475050T.....	89	477150.....	88	4791010O.....	87	485100O.....	88	59030060 ...	51	6182510...	62
475075E.....	89	477200.....	88	4791010T.....	87	485100T.....	88	59030060P...	51	6182513...	62
475075O.....	89	4780505E.....	86	4791012E.....	87	485150E.....	88	59030060T...	51	6182515...	62
475075T.....	89	4780505O.....	86	4791012O.....	87	485150O.....	88	59030060TP...	51	61830075...	62
475100E.....	89	4780505T.....	86	4791012T.....	87	485150T.....	88	59030080 ...	51	6183010...	62
475100O.....	89	4780575E.....	86	4791015E.....	87	485200E.....	88	59030080P...	51	6183013...	62
475100T.....	89	4780575O.....	86	4791015O.....	87	485200O.....	88	59030080T...	51	6183015...	62
475150E.....	89	4780575T.....	86	4791015T.....	87	485200T.....	88	59030080TP...	51	61840075...	62
475150O.....	89	4781010E.....	86	4791075E.....	87	50240P.....	103	6040EPDME...	95	6184010...	62
475150T.....	89	4781010O.....	86	4791075O.....	87	50241P.....	103	6040NITRILS...	95	6184013...	62
475200E.....	89	4781010T.....	86	4791075T.....	87	50242P.....	103	6050EPDME...	95	6184015...	62
475200O.....	89	4781012E.....	86	4791510E.....	87	50243P.....	103	6050NITRILS...	95	61920S.....	60
475200T.....	89	4781012O.....	86	4791510O.....	87	50244P.....	103	60EN3.....	99	61925S.....	60
4760505E.....	87	4781012T.....	86	4791510T.....	87	50245P.....	103	60EPDME.....	92	61930S.....	60
4760505O.....	87	4781015E.....	86	4791512E.....	87	50246P.....	103	60EPDME3 ...	92	61940S.....	60
4760505T.....	87	4781015O.....	86	4791512O.....	87	50247P.....	103	60FLUORO ...	93	61950S.....	60
4760510E.....	87	4781015T.....	86	4791512T.....	87	50248P.....	103	60FLUORO3 ...	94	61960S.....	60
4760510O.....	87	4781075E.....	86	4791515E.....	87	5025.....	49	60NITRILS.....	92	61980S.....	60
4760510T.....	87	4781075O.....	86	4791515O.....	87	5026.....	49	60NITRILS3 ...	92	61H20ENP...	59
4760575E.....	87	4781075T.....	86	4791515T.....	87	5027.....	49	60SILICONE ...	93	61H20NSF...	100
4760575O.....	87	4781505E.....	86	4791520E.....	87	5028.....	49	61020S.....	60	61H25ENP...	59
4760575T.....	87	4781505O.....	86	4791520O.....	87	5029.....	49	61025S.....	60	61H25NSF...	100
4761010E.....	87	4781505T.....	86	4791520T.....	87	5030.....	49	61030S.....	60	61H30ENP...	59
4761010O.....	87	4781510E.....	86	4792012E.....	87	5031.....	49	61040S.....	60	61H30NSF...	100
4761010T.....	87	4781510O.....	86	4792012O.....	87	5032.....	49	61050S.....	60	61H40ENP...	59
4761012E.....	87	4781510T.....	86	4792012T.....	87	5033.....	49	61060S.....	60	61H40NSF...	100
4761012O.....	87	4781515E.....	86	4792015E.....	87	5034.....	49	61080S.....	60	61H50ENP...	59
4761012T.....	87	4781515O.....	86	4792015O.....	87	5035.....	49	6120EN.....	59	61H50NSF...	100
4761015E.....	87	4781515T.....	86	4792015T.....	87	5036.....	49	6120NSF.....	100	61H60ENP...	59
4761015O.....	87	4781575E.....	86	4792020E.....	87	5037.....	49	6125EN.....	59	61H60NSF...	100
4761015T.....	87	4781575O.....	86	4792020O.....	87	5038.....	49	6125NSF.....	100	61PW20.....	101
4761075E.....	87	4781575T.....	86	4792020T.....	87	5039.....	49	6130EN.....	59	61PW25.....	101
4761075O.....	87	4782005E.....	86	4797505E.....	87	5040.....	49	6130NSF.....	100	61PW30.....	101
4761075T.....	87	4782005O.....	86	4797505O.....	87	5040EPDME...	95	6140EN.....	59	61PW40.....	101
4761510E.....	87	4782005T.....	86	4797505T.....	87	5040NITRILS...	95	6140NSF.....	100	61PW50.....	101
4761510O.....	87	4782010E.....	86	4797510E.....	87	5041A.....	49	6150EN.....	59	61PW60.....	101
4761510T.....	87	4782010O.....	86	4797510O.....	87	50EN3.....	99	6150NSF.....	100	6212520...	61
4761512E.....	87	4782010T.....	86	4797510T.....	87	50EPDME.....	92	6160EN.....	59	6213020...	61
4761512O.....	87	4782020E.....	86	4797512E.....	87	50EPDME3 ...	92	6160NSF.....	100	6213025...	61
4761512T.....	87	4782020O.....	86	4797512O.....	87	50FLUORO ...	93	6162520ENP...	58	6214020...	61

See latest catalog or technical data sheets for specific approvals, listings, and design parameters.  
 POA = Price on availability. Prices subject to change without notice.

**Customer Service: (800) 558-5236**

# Tyco Mechanical Products

## Section 15 – Indices



Part No. ....	Page	Part No. ....	Page	Part No. ....	Page	Part No. ....	Page	Part No. ....	Page	Part No. ....	Page
6214025	61	68050EG	63	7024020NITRILS	98	70520OS	10	70580OS	10	70718ES	11
6214030	61	68050EL	63	7024075EPDME	98	70520T3GS	9	70580T3GS	9	70718T3GS	11
6215030	61	68060EG	63	7024075FES	13	70520T3S	9	70580T3S	9	70718T3S	11
6215040	61	68060EL	63	7024075NITRILS	98	70520TGS	9	70580TGS	9	70718TGS	11
6216025	61	7021501EPDME	98	7026001EPDME	98	70520TS	9	70580TS	9	70718TS	11
6216030	61	7021501FES	13	7026001FES	13	70525E3GS	9	70701E3GS	11	70720E3GS	11
6216040	61	7021501NITRILS	98	7026001NITRILS	98	70525E3S	9	70701E3S	11	70720E3S	11
6216050	61	7021505EPDME	98	7026015EPDME	98	70525EGS	9	70701EGS	11	70720EGS	11
64020EHT	58	7021505FES	13	7026015FES	13	70525ES	9	70701ES	11	70720ES	11
64025EHT	58	7021505NITRILS	98	7026015GRVES	14	70525LGS	10	70701T3GS	11	70720LS	12
64030EHT	58	7021575EPDME	98	7026015MES	14	70525LS	10	70701T3S	11	70720OS	12
64040EHT	58	7021575FES	13	7026015NITRILS	98	70525OS	10	70701TGS	11	70720T3GS	11
64050EHT	58	7021575NITRILS	98	7026020EPDME	98	70525T3GS	9	70701TS	11	70720T3S	11
64060EHT	58	7022001EPDME	98	7026020GRVES	14	70525T3S	9	70710E3GS	11	70720TGS	11
64080EHT	58	7022001FES	13	7026020MES	14	70525TGS	9	70710E3S	11	70720TS	11
64520S	60	7022001GRVES	14	7026020NITRILS	98	70525TS	9	70710EGS	11	70721E3GS	11
64525S	60	7022001MES	14	70510E3GS	9	70530E3GS	9	70710ES	11	70721E3S	11
64530S	60	7022001NITRILS	98	70510E3S	9	70530E3S	9	70710LS	12	70721EGS	11
64540S	60	7022005EPDME	98	70510EGS	9	70530EGS	9	70710OS	12	70721ES	11
64550S	60	7022005FES	13	70510ES	9	70530ES	9	70710T3GS	11	70721T3GS	11
64560S	60	7022005NITRILS	98	70510LGS	10	70530LGS	10	70710T3S	11	70721T3S	11
64580S	60	7022075EPDME	98	70510LS	10	70530LS	10	70710TGS	11	70721TGS	11
6502520	61	7022075FES	13	70510OS	10	70530OS	10	70710TS	11	70721TS	11
6503020	61	7022075NITRILS	98	70510T3GS	9	70530T3GS	9	70712E3GS	11	70724E3GS	11
6503025	61	7022501EPDME	98	70510T3S	9	70530T3S	9	70712E3S	11	70724E3S	11
6504020	61	7022501FES	13	70510TGS	9	70530TGS	9	70712EGS	11	70724EGS	11
6504025	61	7022501NITRILS	98	70510TS	9	70530TS	9	70712ES	11	70724ES	11
6504030	61	7022505EPDME	98	70512E3GS	9	70540E3GS	9	70712LS	12	70724T3GS	11
6505030	61	7022505FES	13	70512E3S	9	70540E3S	9	70712OS	12	70724T3S	11
6505040	61	7022505NITRILS	98	70512EGS	9	70540EGS	9	70712T3GS	11	70724TGS	11
6506030	61	7022513EPDME	98	70512ES	9	70540ES	9	70712T3S	11	70724TS	11
6506040	61	7022513GRVES	14	70512LGS	10	70540LGS	10	70712TGS	11	70725E3GS	11
6506050	61	7022513MES	14	70512LS	10	70540LS	10	70712TS	11	70725E3S	11
6508060	61	7022513NITRILS	98	70512OS	10	70540OS	10	70714E3GS	11	70725EGS	11
6522010W	61	7022515EPDME	98	70512T3GS	9	70540T3GS	9	70714E3S	11	70725ES	11
6522013W	61	7022515GRVES	14	70512T3S	9	70540T3S	9	70714EGS	11	70725LS	12
6522015W	61	7022515MES	14	70512TGS	9	70540TGS	9	70714ES	11	70725OS	12
6522510W	61	7022575EPDME	98	70512TS	9	70540TS	9	70714LS	12	70725T3GS	11
6522513W	61	7022575FES	13	70513E3GS	9	70550E3GS	9	70714OS	12	70725T3S	11
6522515W	61	7022575NITRILS	98	70513E3S	9	70550E3S	9	70714T3GS	11	70725TGS	11
6522520W	61	7023001EPDME	98	70513EGS	9	70550EGS	9	70714T3S	11	70725TS	11
6523015W	61	7023001FES	13	70513ES	9	70550ES	9	70714TGS	11	70730E3GS	11
6523020W	61	7023001GRVES	14	70513LGS	10	70550LGS	10	70714TS	11	70730E3S	11
6524020W	61	7023001MES	14	70513LS	10	70550LS	10	70715E3GS	11	70730EGS	11
66020S	60	7023001NITRILS	98	70513OS	10	70550OS	10	70715E3S	11	70730ES	11
66025S	60	7023013EPDME	98	70513T3GS	9	70550T3GS	9	70715EGS	11	70730LS	12
66030S	60	7023013NITRILS	98	70513T3S	9	70550T3S	9	70715ES	11	70730OS	12
66040S	60	7023015EPDME	98	70513TGS	9	70550TGS	9	70715LS	12	70730T3GS	11
66050S	60	7023015GRVES	14	70513TS	9	70550TS	9	70715OS	12	70730T3S	11
66060S	60	7023015MES	14	70515E3GS	9	70560E3GS	9	70715T3GS	11	70730TGS	11
66080S	60	7023015NITRILS	98	70515E3S	9	70560E3S	9	70715T3S	11	70730TS	11
67220EN3	58	7023075EPDME	98	70515EGS	9	70560EGS	9	70715TGS	11	70740E3GS	11
67225EN3	58	7023075FES	13	70515ES	9	70560ES	9	70715TS	11	70740E3S	11
67230EN3	58	7023075NITRILS	98	70515LGS	10	70560LGS	10	70716E3GS	11	70740EGS	11
67240EN3	58	7024001EPDME	98	70515LS	10	70560LS	10	70716E3S	11	70740ES	11
67250EN3	58	7024001FES	13	70515OS	10	70560OS	10	70716EGS	11	70740LS	12
67260EN3	58	7024001MES	14	70515T3GS	9	70560T3GS	9	70716ES	11	70740OS	12
67280EN3	58	7024001NITRILS	98	70515T3S	9	70560T3S	9	70716LS	12	70740T3GS	11
68020EG	63	7024015EPDME	98	70515TGS	9	70560TGS	9	70716OS	12	70740T3S	11
68020EL	63	7024015FES	13	70515TS	9	70560TS	9	70716T3GS	11	70740TGS	11
68025EG	63	7024015GRVES	14	70520E3GS	9	70580E3GS	9	70716T3S	11	70740TS	11
68025EL	63	7024015MES	14	70520E3S	9	70580E3S	9	70716TGS	11	70750E3GS	11
68030EG	63	7024015NITRILS	98	70520EGS	9	70580EGS	9	70716TS	11	70750E3S	11
68030EL	63	7024020EPDME	98	70520ES	9	70580ES	9	70718E3GS	11	70750EGS	11
68040EG	63	7024020GRVES	14	70520LGS	10	70580LGS	10	70718E3S	11	70750ES	11
68040EL	63	7024020MES	14	70520LS	10	70580LS	10	70718EGS	11	70750LS	12

Introduction  
Couplings & Fittings  
Mechanical Tees  
Valves  
Circuit Balancing Valves  
Accessories  
Copper Systems  
Stainless Steel Systems  
Plain End Systems  
Stainless Steel G-PRESS  
HDPE Systems  
Gaskets & Spare Parts  
Preparation Equipment  
Miscellaneous  
Indices

Customer Service: (800) 558-5236

See latest catalog or technical data sheets for specific approvals, listings, and design parameters.

POA = Price on availability. Prices subject to change without notice.

Part No. ....	Page	Part No. ....	Page	Part No. ....	Page	Part No. ....	Page	Part No. ....	Page	Part No. ....	Page
70750OS	12	7112FWC	96	7140EPDME	96	7168060EGS	13	71H80OGS	15	72696	31
70750T3GS	11	7112GS	16	7140FW	96	7168060ES	13	71H80OS	15	72697	31
70750T3S	11	7112NITRILS	96	7140FWC	96	7168060TGS	13	71H80S	15	72698	31
70750TGS	11	7112S	16	7140GS	16	7168060TS	13	71H80TGS	15	72699	31
70750TS	11	7112TGS	16	7140NITRILS	96	7180EPDME	96	71H80TS	15	72852	27
70760E3GS	11	7112TS	16	7140S	16	7180FLUORO	96	71H10GS	15	72853	27
70760E3S	11	7114EPDME	96	7140TGS	16	7180FW	96	71H10OGS	15	72854	27
70760EGS	11	7114FWC	96	7140TS	16	7180FWC	96	71H10OS	15	72855	27
70760ES	11	7114GS	16	7150EPDME	96	7180GS	16	71H10S	15	72860	27
70760LS	12	7114NITRILS	96	7150FW	96	7180NITRILS	96	71H10TGS	15	72861	27
70760OS	12	7114S	16	7150FWC	96	7180S	16	71H10TS	15	72867	27
70760T3GS	11	7114TGS	16	7150GS	16	7180TGS	16	71H12GS	15	72868	27
70760T3S	11	7114TS	16	7150NITRILS	96	7180TS	16			72869	27
70760TGS	11	7116EPDME	96	7150S	16	71H20EPDME	96	71H12OGS	15	72876	27
70760TS	11	7116FWC	96	7150TGS	16	71H20FLUORO	96	71H12OS	15	72877	27
70780E3GS	11	7116GS	16	7150TS	16	71H20GS	15	71H12S	15	72889	27
70780E3S	11	7116NITRILS	96	7160EPDME	96	71H20NITRILS	96	71H12TGS	15	72897	28
70780EGS	11	7116S	16	7160FLUORO	96	71H20OGS	15	71H12TS	15	72898	28
70780ES	11	7116TGS	16	7160FW	96	71H20OS	15	72032	35	72899	28
70780LS	12	7116TS	16	7160FWC	96	71H20S	15	72035	35	72900	28
70780OS	12	7118EPDME	96	7160GS	16	71H20TGS	15	72601	32	72901	28
70780T3GS	11	7118FWC	96	7160NITRILS	96	71H20TS	15	72602	32	72902	28
70780T3S	11	7118GS	16	7160S	16	71H25EPDME	96	72603	32	72903	28
70780TGS	11	7118NITRILS	96	7160TGS	16	71H25FLUORO	96	72604	32	72904	28
70780TS	11	7118S	16	7160TS	16	71H25GS	15	72605	32	72906	28
707L26EGS	12	7118TGS	16	7162015EGS	13	71H25NITRILS	96	72606	32	72910	28
707L26ES	12	7118TS	16	7162015ES	13	71H25OGS	15	72607	32	72911	28
707L26TGS	12	7120EPDME	96	7162015TGS	13	71H25OS	15	72608	32	72915	28
707L26TS	12	7120FW	96	7162015TS	13	71H25S	15	72609	32	72920	28
707L28EGS	12	7120FWC	96	7162520EGS	13	71H25TGS	15	72610	32	72921	28
707L28ES	12	7120GS	16	7162520ES	13	71H25TS	15	72611	32	72922	28
707L28TS	12	7120NITRILS	96	7162520TGS	13	71H30EPDME	96	72612	32	72923	28
707L28TGS	12	7120S	16	7162520TS	13	71H30FLUORO	96	72613	32	72924	28
707L30EGS	12	7120TGS	16	7163020EGS	13	71H30GS	15	72614	32	72925	28
707L30ES	12	7120TS	16	7163020ES	13	71H30NITRILS	96	72620	31	72930	28
707L30TGS	12	7121EPDME	96	7163020TGS	13	71H30OGS	15	72622	31	72931	28
707L30TS	12	7121FWC	96	7163020TS	13	71H30OS	15	72623	31	72932	28
707L32EGS	12	7121GS	16	7163025EGS	13	71H30S	15	72645	22	72933	28
707L32ES	12	7121NITRILS	96	7163025ES	13	71H30TGS	15	72646	22	72939	29
707L32TGS	12	7121S	16	7163025TGS	13	71H30TS	15	72647	22	72941	29
707L32TS	12	7121TGS	16	7163025TS	13	71H40EPDME	96	72649	22	72946	29
707L36EGS	12	7121TS	16	7164020EGS	13	71H40FLUORO	96	72650	22	72947	29
707L36ES	12	7124EPDME	96	7164020ES	13	71H40GS	15	72651	22	72948	29
707L36TGS	12	7124FWC	96	7164020TGS	13	71H40NITRILS	96	72652	22	72949	29
707L36TS	12	7124GS	16	7164020TS	13	71H40OGS	15	72653	22	72950	29
707L40EGS	12	7124NITRILS	96	7164025EGS	13	71H40OS	15	72670	22	72951	29
707L40ES	12	7124S	16	7164025ES	13	71H40S	15	72671	22	72952	29
707L40TGS	12	7124TGS	16	7164025TGS	13	71H40TGS	15	72672	22	72953	29
707L40TS	12	7124TS	16	7164025TS	13	71H40TS	15	72673	22	72954	29
707L42EGS	12	7125EPDME	96	7164030EGS	13	71H50EPDME	96	72674	22	72955	29
707L42ES	12	7125FW	96	7164030ES	13	71H50FLUORO	96	72675	22	72956	29
707L42TGS	12	7125FWC	96	7164030TGS	13	71H50GS	15	72680	31	72958	29
707L42TS	12	7125GS	16	7164030TS	13	71H50NITRILS	96	72681	31	72963	29
7110EPDME	96	7125NITRILS	96	7165040EGS	13	71H50OGS	15	72682	31	7302005EGS	42
7110FLUORO	96	7125S	16	7165040ES	13	71H50OS	15	72683	31	7302005ES	42
7110FW	96	7125TGS	16	7165040TGS	13	71H50S	15	72684	31	7302005TGS	42
7110FWC	96	7125TS	16	7165040TS	13	71H50TGS	15	72685	31	7302005TS	42
7110GS	16	7130EPDME	96	7166040EGS	13	71H50TS	15	72686	31	73020075EGS	42
7110NITRILS	96	7130FW	96	7166040ES	13	71H60GS	15	72687	31	73020075ES	42
7110S	16	7130FWC	96	7166040TGS	13	71H60OGS	15	72688	31	73020075TGS	42
7110TGS	16	7130GS	16	7166040TS	13	71H60OS	15	72691	31	73020075TS	42
7110TS	16	7130NITRILS	96	7166050EGS	13	71H60S	15	72692	31	7302010ECS	44
7112EPDME	96	7130S	16	7166050ES	13	71H60TGS	15	72693	31	7302010EGCS	44
7112FLUORO	96	7130TGS	16	7166050TGS	13	71H60TS	15	72694	31	7302010EGS	42
7112FW	96	7130TS	16	7166050TS	13	71H80GS	15	72695	31	7302010ES	42

See latest catalog or technical data sheets for specific approvals, listings, and design parameters.  
 POA = Price on availability. Prices subject to change without notice.

Customer Service: (800) 558-5236

[www.grinnell.com](http://www.grinnell.com)

# Tyco Mechanical Products

## Section 15 – Indices



Part No. ....	Page	Part No. ....	Page	Part No. ....	Page	Part No. ....	Page	Part No. ....	Page	Part No. ....	Page
7302010TCS	44	7302513TRS	43	7303015TCS	44	7304015TGRCS	45	7305020ECS	44	7306015TGRCS	45
7302010TGCS	44	7302513TS	42	7303015TGCS	44	7304015TGRS	43	7305020EGCS	44	7306015TGRS	43
7302010TGS	42	7302515ECS	44	7303015TGRCS	45	7304015TGS	42	7305020EGRCS	45	7306015TGS	42
7302010TS	42	7302515EGCS	44	7303015TGRS	43	7304015TRCS	45	7305020EGRS	43	7306015TRCS	45
7302013ECS	44	7302515EGRCS	45	7303015TGS	42	7304015TRS	43	7305020EGS	42	7306015TRS	43
7302013EGCS	44	7302515EGRS	43	7303015TRCS	45	7304015TS	42	7305020ERCS	45	7306015TS	42
7302013EGRCS	45	7302515EGS	42	7303015TRS	43	7304020ECS	44	7305020ERS	43	7306020ECS	44
7302013EGRS	43	7302515ERCS	45	7303015TS	42	7304020EGCS	44	7305020ES	42	7306020EGCS	44
7302013EGS	42	7302515ERS	43	7303020ECS	44	7304020EGRCS	45	7305020TCS	44	7306020EGRCS	45
7302013ERCS	45	7302515ES	42	7303020EGCS	44	7304020EGRS	43	7305020TGCS	44	7306020EGRS	43
7302013ERS	43	7302515ECS	44	7303020EGRCS	45	7304020EGS	42	7305020TGRCS	45	7306020EGS	42
7302013ES	42	7302515TGCS	44	7303020EGRS	43	7304020ERCS	45	7305020TGRS	43	7306020ERCS	45
7302013TCS	44	7302515TGRCS	45	7303020EGS	42	7304020ERS	43	7305020TGS	42	7306020ERS	43
7302013TGCS	44	7302515TGRS	43	7303020ERCS	45	7304020ES	42	7305020TRCS	45	7306020ES	42
7302013TGRCS	45	7302515TGS	42	7303020ERS	43	7304020TCS	44	7305020TRS	43	7306020TCS	44
7302013TGRS	43	7302515TRCS	45	7303020ES	42	7304020TGCS	44	7305020TS	42	7306020TGCS	44
7302013TGS	42	7302515TRS	43	7303020TCS	44	7304020TGRCS	45	7305025ECS	44	7306020TGRCS	45
7302013TRCS	45	7302515TS	42	7303020TGCS	44	7304020TGRS	43	7305025EGCS	44	7306020TGRS	43
7302013TRS	43	7302520EGP	42	7303020TGRC	45	7304020TGS	42	7305025EGRCS	45	7306020TGS	42
7302013TS	42	7302520EGRP	43	7303020TGRS	43	7304020TRCS	45	7305025EGRS	43	7306020TRCS	45
7302015ECS	44	7302520EP	42	7303020TGS	42	7304020TRS	43	7305025EGS	42	7306020TRS	43
7302015EGCS	44	7302520ERP	43	7303020TRCS	45	7304020TS	42	7305025ERCS	45	7306020TS	42
7302015EGRCS	45	7302520TGP	42	7303020TRS	43	7304025ECS	44	7305025ERS	43	7306025ECS	44
7302015EGRS	43	7302520TRP	43	7303020TS	42	7304025EGCS	44	7305025ES	42	7306025EGCS	44
7302015EGS	42	7302520TP	42	7304005EGS	42	7304025EGRCS	45	7305025TCS	44	7306025EGRCS	45
7302015ERCS	45	7302520TRP	43	7304005ES	42	7304025EGRS	43	7305025TGCS	44	7306025EGRS	43
7302015ERS	43	7303005EGS	42	7304005TGS	42	7304025EGS	42	7305025TGRCS	45	7306025EGS	42
7302015ES	42	7303005ES	42	7304005TS	42	7304025ERCS	45	7305025TGRS	43	7306025ERCS	45
7302015TCS	44	7303005TGS	42	73040075EGS	42	7304025ERS	43	7305025TGS	42	7306025ERS	43
7302015TGCS	44	7303005TS	42	73040075ES	42	7304025ES	42	7305025TRCS	45	7306025ES	42
7302015TGRCS	45	73030075EGS	42	73040075TGS	42	7304025TCS	44	7305025TRS	43	7306025TCS	44
7302015TGRS	43	73030075ES	42	73040075TS	42	7304025TGCS	44	7305025TS	42	7306025TGCS	44
7302015TGS	42	73030075TGS	42	7304010ECS	44	7304025TGRCS	45	7305030ECP	44	7306025TGRCS	45
7302015TRCS	45	73030075TS	42	7304010EGCS	44	7304025TGRS	43	7305030EGCP	44	7306025TGRS	43
7302015TRS	43	7303010ECS	44	7304010EGS	42	7304025TGS	42	7305030ECP	42	7306025TGS	42
7302015TS	42	7303010EGCS	44	7304010ES	42	7304025TRCS	45	7305030EGRCS	45	7306025TRCS	45
7302505EGS	42	7303010EGS	42	7304010TCS	44	7304025TRS	43	7305030EGRP	43	7306025TRS	43
7302505ES	42	7303010ES	42	7304010TGCS	44	7304025TS	42	7305030ERP	42	7306025TS	42
7302505TGS	42	7303010TCS	44	7304010TGS	42	7304030ECS	44	7305030ERCS	45	7306030ECS	44
7302505TS	42	7303010TGCS	44	7304010TS	42	7304030EGCS	44	7305030ERP	43	7306030EGCS	44
73025075EGS	42	7303010TGS	42	7304013ECS	44	7304030EGRCS	45	7305030TCP	44	7306030EGRCS	45
73025075ES	42	7303010TS	42	7304013EGCS	44	7304030EGRS	43	7305030TGCP	44	7306030EGRS	43
73025075TGS	42	7303013ECS	44	7304013EGRCS	45	7304030EGS	42	7305030TGP	42	7306030EGS	42
73025075TS	42	7303013EGCS	44	7304013EGRS	43	7304030ERCS	45	7305030TGRCS	45	7306030ERCS	45
7302510ECS	44	7303013EGRCS	45	7304013EGS	42	7304030ERS	43	7305030TRGP	43	7306030ERS	43
7302510EGCS	44	7303013EGRS	43	7304013ERCS	45	7304030ES	42	7305030TP	42	7306030ES	42
7302510EGS	42	7303013EGS	42	7304013ERS	43	7304030TCS	44	7305030TRCS	45	7306030TCS	44
7302510ES	42	7303013ERCS	45	7304013ES	42	7304030TGCS	44	7305030TRP	43	7306030TGCS	44
7302510TCS	44	7303013ERS	43	7304013TCS	44	7304030TGRCS	45	7306013EGP	42	7306030TGRCS	45
7302510TGCS	44	7303013ES	42	7304013TGCS	44	7304030TGRS	43	7306013EGRP	43	7306030TGRS	43
7302510TGS	42	7303013TCS	44	7304013TGRCS	45	7304030TGS	42	7306013ERP	42	7306030TGS	42
7302510TS	42	7303013TGCS	44	7304013TGRS	43	7304030TRCS	45	7306013TRP	43	7306030TRCS	45
7302513ECS	44	7303013TGRCS	45	7304013TGS	42	7304030TRS	43	7306013TGP	42	7306030TRS	43
7302513EGCS	44	7303013TGRS	43	7304013TRCS	45	7304030TS	42	7306013TRGP	43	7306030TS	42
7302513EGRCS	45	7303013TGS	42	7304013TRS	43	7304075ECS	44	7306013TP	42	7306040ECS	44
7302513EGRS	43	7303013TRCS	45	7304013TS	42	7304075EGCS	44	7306013TRP	43	7306040EGCS	44
7302513EGS	42	7303013TRS	43	7304015ECS	44	7304075TCS	44	7306015ECS	44	7306040EGRCS	45
7302513ERCS	45	7303013TS	42	7304015EGCS	44	7304075TGCS	44	7306015EGCS	44	7306040EGRS	43
7302513ERS	43	7303015ECS	44	7304015EGRCS	45	7305015EGP	42	7306015EGRCS	45	7306040EGS	42
7302513ES	42	7303015EGCS	44	7304015EGRS	43	7305015EGRP	43	7306015EGRS	43	7306040ERCS	45
7302513TCS	44	7303015EGRCS	45	7304015EGS	42	7305015EP	42	7306015EGS	42	7306040ERS	43
7302513TGCS	44	7303015EGRS	43	7304015ERCS	45	7305015ERP	43	7306015ERCS	45	7306040ES	42
7302513TGRCS	45	7303015EGS	42	7304015ERS	43	7305015TGP	42	7306015ERS	43	7306040TCS	44
7302513TGRS	43	7303015ERCS	45	7304015ES	42	7305015TGRP	43	7306015ES	42	7306040TGCS	44
7302513TGS	42	7303015ERS	43	7304015TCS	44	7305015TP	42	7306015TCS	44	7306040TGRCS	45
7302513TRCS	45	7303015ES	42	7304015TGCS	44	7305015TRP	43	7306015TGCS	44	7306040TGRS	43

Introduction
Couplings & Fittings
Mechanical Tees
Valves
Circuit Balancing Valves
Accessories
Copper Systems
Stainless Steel Systems
Plain End Systems
Stainless Steel G-PRESS
HDPE Systems
Gaskets & Spare Parts
Preparation Equipment
Miscellaneous
Indices

Customer Service: (800) 558-5236

[www.grinnell.com](http://www.grinnell.com)

See latest catalog or technical data sheets for specific approvals, listings, and design parameters.

POA = Price on availability. Prices subject to change without notice.

Part No. ....	Page	Part No. ....	Page	Part No. ....	Page	Part No. ....	Page	Part No. ....	Page	Part No. ....	Page
7306040TGS	42	730TGS-6	97	73583	25	73806	36	73935	33	74080NITRILS	98
7306040TRCS	45	730TGS-7	97	73584	25	73807	36	73937	33	74080TGS	6
7306040TRS	43	730TGS-8	97	73585	25	73808	36	73949	33	74080TS	6
7306040TS	42	730TGS-9	97	73587	25	73809	36	73950	33	74208	34
7308025ECS	44	73230	38	73589	24	73810	36	73957	35	74209	34
7308025EGCS	44	73231	38	73590	24	73811	36	73962	35	74210	34
7308025EGRCS	45	73232	38	73591	24	73812	28	73969	35	74211	34
7308025EGRS	43	73233	38	73593	24	73813	28	73970	35	74212	34
7308025EGS	42	73234	38	73594	24	73814	28	73971	35	74214	34
7308025ERCS	45	73235	38	73595	24	73815	28	73972	35	74217	34
7308025ERS	43	73236	38	73599	24	73816	28	73973	35	74218	34
7308025ES	42	73237	38	73600	24	73817	28	73976	35	74219	34
7308025TCS	44	73238	38	73608	25	73818	29	73979	35	74220	34
7308025TGCS	44	73239	38	73609	25	73819	29	73980	35	74221	34
7308025TGRCS	45	73240	38	73610	25	73820	29	73981	35	74222	34
7308025TGRS	43	73241	38	73611	25	73823	29	73983	35	74223	34
7308025TGS	42	73242	38	73620	24	73825	29	73986	35	74224	34
7308025TRCS	45	73243	38	73621	24	73830	29	73987	35	74225	34
7308025TRS	43	73251	38	73622	24	73831	29	73988	35	74226	34
7308025TS	42	73252	38	73624	24	73832	29	73989	35	74228	34
7308030ECS	44	73253	38	73625	24	73833	29	73990	35	74229	34
7308030EGCS	44	73254	38	73627	24	73836	29	73992	35	74231	34
7308030EGRCS	45	73255	38	73629	24	73837	29	73993	35	74233	34
7308030EGRS	43	73256	38	73630	24	73838	29	73995	35	74234	34
7308030EGS	42	73260	38	73631	24	73840	29	73996	35	74240	38
7308030ERCS	45	73261	38	73633	24	73841	29	73997	35	74241	38
7308030ERS	43	73262	38	73635	25	73842	29	73998	35	74245	38
7308030ES	42	73264	38	73636	25	73843	29	74020EGHT	6	74254	38
7308030TCS	44	73393	27	73647	25	73846	28	74020EHT	6	74259	38
7308030TGCS	44	73396	27	73648	25	73851	28	74020EPDME	98	74260	38
7308030TGRCS	45	73399	27	73649	25	73860	29	74020NITRILS	98	74263	38
7308030TGRS	43	73400	27	73650	25	73861	29	74020TGS	6	74264	38
7308030TGS	42	73402	27	73651	25	73875	29	74020TS	6	74265	38
7308030TRCS	45	73403	27	73652	25	73877	29	74025EGHT	6	74268	38
7308030TRS	43	73404	27	73653	25	73878	29	74025EHT	6	74276	38
7308030TS	42	73406	27	73659	26	73883	29	74025EPDME	98	74278	38
7308040ECS	44	73409	27	73691	25	73884	29	74025NITRILS	98	74283	38
7308040EGCS	44	73410	27	73694	26	73885	29	74025TGS	6	74292	30
7308040EGRCS	45	73500	18	73696	26	73887	29	74025TS	6	74293	30
7308040EGRS	43	73501	18	73729	36	73888	29	74030EGHT	6	74294	30
7308040EGS	42	73506	18	73730	36	73892	29	74030EHT	6	74295	30
7308040ERCS	45	73507	18	73743	36	73893	29	74030EPDME	98	74296	30
7308040ERS	43	73508	18	73749	27	73897	29	74030NITRILS	98	74297	30
7308040ES	42	73509	18	73750	27	73898	29	74030TGS	6	74309	31
7308040TCS	44	73510	18	73751	28	73899	29	74030TS	6	74311	31
7308040TGCS	44	73512	18	73752	28	73913	33	74040EGHT	6	74327	33
7308040TGRCS	45	73517	18	73753	28	73914	33	74040EHT	6	74328	27
7308040TGRS	43	73525	18	73754	28	73915	33	74040EPDME	98	74330	31
7308040TGS	42	73526	18	73761	27	73916	33	74040NITRILS	98	74331	31
7308040TRCS	45	73528	18	73764	27	73917	33	74040TGS	6	74335	30
7308040TRS	43	73542	22	73770	28	73918	33	74040TS	6	74336	30
7308040TS	42	73543	22	73771	28	73919	33	74050EGHT	6	74337	30
730EGS-1	97	73544	22	73774	28	73920	33	74050EHT	6	74338	30
730EGS-2	97	73565	23	73779	28	73921	33	74050EPDME	98	74339	31
730EGS-3	97	73566	23	73784	28	73922	33	74050NITRILS	98	74672	33
730EGS-4	97	73567	23	73785	28	73923	33	74050TGS	6	74673	33
730EGS-5	97	73572	23	73786	28	73924	33	74050TS	6	74675	33
730EGS-6	97	73574	24	73787	28	73925	33	74060EGHT	6	74676	33
730EGS-7	97	73575	24	73792	30	73926	33	74060EHT	6	74677	33
730EGS-8	97	73576	24	73793	30	73927	33	74060EPDME	98	74678	33
730EGS-9	97	73577	24	73797	30	73928	33	74060NITRILS	98	74679	33
730TGS-1	97	73578	24	73799	30	73929	33	74060TGS	6	74680	33
730TGS-2	97	73579	24	73802	30	73930	33	74060TS	6	74681	33
730TGS-3	97	73580	24	73803	36	73931	33	74080EGHT	6	74682	33
730TGS-4	97	73581	25	73804	36	73932	33	74080EHT	6	74683	33
730TGS-5	97	73582	25	73805	36	73933	33	74080EPDME	98	74684	33

See latest catalog or technical data sheets for specific approvals, listings, and design parameters.  
 POA = Price on availability. Prices subject to change without notice.

**Customer Service: (800) 558-5236**



# Tyco Mechanical Products

## Section 15 – Indices



Part No. ....	Page	Part No. ....	Page	Part No. ....	Page	Part No. ....	Page	Part No. ....	Page	Part No. ....	Page
74685	33	75433	24	7550-1-25G	56	7550-13-50T	56	7550-75-12G	57	75519	26
74686	33	75435	24	7550-1-25GT	56	7550-13-60	56	7550-75-12GT	57	75520	25
74687	33	75437	24	7550-1-25T	56	7550-13-60G	56	7550-75-12T	57	75521	25
74688	33	75439	24	7550-1-30	56	7550-13-60GT	56	7550-75-13	56	75522	25
74689	33	75440	24	7550-1-30G	56	7550-13-60T	56	7550-75-13G	56	75523	25
74690	33	75441	24	7550-1-30GT	56	7550-13-80	56	7550-75-13GT	56	75524	25
74691	33	75442	24	7550-1-30T	56	7550-13-80G	56	7550-75-13T	56	75525	25
74692	33	75443	24	7550-1-40	56	7550-13-80GT	56	7550-75-14	57	75526	25
74700	32	75444	24	7550-1-40G	56	7550-13-80T	56	7550-75-14G	57	75527	26
74701	32	75445	24	7550-1-40GT	56	7550-15-10	57	7550-75-14GT	57	75528	26
74702	32	75446	24	7550-1-40T	56	7550-15-10G	57	7550-75-14T	57	75529	26
74703	32	75447	24	7550-1-50	56	7550-15-10GT	57	7550-75-15	56	75534	25
74704	32	75448	24	7550-1-50G	56	7550-15-10T	57	7550-75-15G	56	75535	25
74705	32	75449	24	7550-1-50GT	56	7550-15-12	57	7550-75-15GT	56	75541	25
75098	31	75450	25	7550-1-50T	56	7550-15-12G	57	7550-75-15T	56	75546	25
75099	31	75451	25	7550-1-60	56	7550-15-12GT	57	7550-75-16	57	75590	26
75100	31	75452	25	7550-1-60G	56	7550-15-12T	57	7550-75-16G	57	75670	33
75101	31	75453	25	7550-1-60GT	56	7550-15-13	56	7550-75-16GT	57	75671	33
75102	31	75454	25	7550-1-60T	56	7550-15-13G	56	7550-75-16T	57	75672	33
75103	31	75455	25	7550-1-80	56	7550-15-13GT	56	7550-75-20	56	75673	33
75104	31	75456	25	7550-1-80G	56	7550-15-13T	56	7550-75-20G	56	75674	33
75105	31	75457	25	7550-1-80GT	56	7550-15-14	57	7550-75-20GT	56	75675	33
75106	31	75458	25	7550-1-80T	56	7550-15-14G	57	7550-75-20T	56	75676	33
75107	31	75459	25	7550-13-10	57	7550-15-14GT	57	7550-75-25	56	75677	33
75108	31	75460	25	7550-13-10G	57	7550-15-14T	57	7550-75-25G	56	75678	33
75121	30	75461	24	7550-13-10GT	57	7550-15-15	56	7550-75-25GT	56	75679	33
75122	30	75466	23	7550-13-10T	57	7550-15-15G	56	7550-75-25T	56	75680	33
75123	30	75466	23	7550-13-12	57	7550-15-15GT	56	7550-75-30	56	75681	33
75124	30	75469	25	7550-13-12G	57	7550-15-15T	56	7550-75-30G	56	75682	33
75125	30	75470	24	7550-13-12GT	57	7550-15-16	57	7550-75-30GT	56	75683	33
75126	30	75482	24	7550-13-12T	57	7550-15-16G	57	7550-75-30T	56	75684	33
75129	30	75484	24	7550-13-13	56	7550-15-16GT	57	7550-75-40	56	75685	33
75130	30	75486	24	7550-13-13G	56	7550-15-16T	57	7550-75-40G	56	75686	33
75131	30	75488	36	7550-13-13GT	56	7550-15-20	56	7550-75-40GT	56	75687	33
75132	30	75490	23	7550-13-13T	56	7550-15-20G	56	7550-75-40T	56	75688	33
75133	30	75491	23	7550-13-14	57	7550-15-20GT	56	7550-75-50	56	75689	33
75148	31	75492	23	7550-13-14G	57	7550-15-20T	56	7550-75-50G	56	75690	33
75150	31	75493	23	7550-13-14GT	57	7550-15-25	56	7550-75-50GT	56	75691	33
75151	31	7550-1-10	57	7550-13-14T	57	7550-15-25G	56	7550-75-50T	56	75692	33
75152	31	7550-1-10G	57	7550-13-15	56	7550-15-25GT	56	7550-75-60	56	75695	33
75153	31	7550-1-10GT	57	7550-13-15G	56	7550-15-25T	56	7550-75-60G	56	75700	32
75154	31	7550-1-10T	57	7550-13-15GT	56	7550-15-30	56	7550-75-60GT	56	75701	32
75155	31	7550-1-12	57	7550-13-15T	56	7550-15-30G	56	7550-75-60T	56	75702	32
75156	31	7550-1-12G	57	7550-13-16	57	7550-15-30GT	56	7550-75-80	56	75703	32
75157	31	7550-1-12GT	57	7550-13-16G	57	7550-15-30T	56	7550-75-80G	56	75704	32
75158	31	7550-1-12T	57	7550-13-16GT	57	7550-15-40	56	7550-75-80GT	56	75705	32
75309	17	7550-1-13	56	7550-13-16T	57	7550-15-40G	56	7550-75-80T	56	75706	32
75310	17	7550-1-13G	56	7550-13-20	56	7550-15-40GT	56	75500	25	75707	32
75311	17	7550-1-13GT	56	7550-13-20G	56	7550-15-40T	56	75501	25	75708	32
75312	17	7550-1-13T	56	7550-13-20GT	56	7550-15-50	56	75502	25	75710	32
75315	17	7550-1-14	57	7550-13-20T	56	7550-15-50G	56	75503	25	75711	32
75323	17	7550-1-14G	57	7550-13-25	56	7550-15-50GT	56	75504	25	75712	32
75324	17	7550-1-14GT	57	7550-13-25G	56	7550-15-50T	56	75505	25	75730	35
75325	17	7550-1-14T	57	7550-13-25GT	56	7550-15-60	56	75506	25	75731	35
75326	17	7550-1-15	56	7550-13-25T	56	7550-15-60G	56	75507	25	75732	35
75327	17	7550-1-15G	56	7550-13-30	56	7550-15-60GT	56	75508	25	75734	34
75328	17	7550-1-15GT	56	7550-13-30G	56	7550-15-60T	56	75509	25	75735	35
75408	25	7550-1-15T	56	7550-13-30GT	56	7550-15-80	56	75510	25	75736	34
75409	25	7550-1-16	57	7550-13-30T	56	7550-15-80G	56	75511	25	75737	34
75410	24	7550-1-16G	57	7550-13-40	56	7550-15-80GT	56	75512	25	75738	35
75412	24	7550-1-16GT	57	7550-13-40G	56	7550-15-80T	56	75513	25	75742	35
75413	24	7550-1-16T	57	7550-13-40GT	56	7550-75-10	57	75514	26	75746	34
75414	24	7550-1-20	56	7550-13-40T	56	7550-75-10G	57	75515	26	75752	35
75420	24	7550-1-20G	56	7550-13-50	56	7550-75-10GT	57	75516	26	75758	35
75421	24	7550-1-20GT	56	7550-13-50G	56	7550-75-10T	57	75517	26	75759	35
75425	24	7550-1-20T	56	7550-13-50GT	56	7550-75-12	57	75518	26	75761	22

Introduction	25
Couplings & Fittings	25
Mechanical Tees	25
Valves	25
Circuit Balancing Valves	33
Accessories	33
Copper Systems	33
Stainless Steel Systems	33
Plain End Systems	33
Stainless Steel G-PRESS	32
HDPE Systems	32
Gaskets & Spare Parts	35
Preparation Equipment	34
Miscellaneous	35
Indices	22

Customer Service: (800) 558-5236

[www.grinnell.com](http://www.grinnell.com)

See latest catalog or technical data sheets for specific approvals, listings, and design parameters.  
 POA = Price on availability. Prices subject to change without notice.

Part No. ....	Page	Part No. ....	Page	Part No. ....	Page	Part No. ....	Page	Part No. ....	Page	Part No. ....	Page
75762	22	76057	41	76836	30	77021	40	77213TGS	7	77221OS	8
75763	22	76058	41	76837	30	77022	40	77213TS	7	77221T3GS	7
75764	22	76059	41	76838	30	77023	40	77214E3GS	7	77221T3S	7
75765	22	76060	41	76839	30	77024	40	77214E3S	7	77221TGS	7
75766	22	76061	41	76840	39	77025	40	77214EGS	7	77221TS	7
75767	22	76062	41	76841	39	77025EGS	14	77214ES	7	77224E3GS	7
75780	18	76063	41	76842	39	77025ES	14	77214LGS	8	77224E3S	7
75781	18	76064	41	76843	39	77025TGS	14	77214LS	8	77224EGS	7
75782	18	76065	41	76844	39	77025TS	14	77214OGS	8	77224ES	7
75783	18	76066	41	76845	39	77026	40	77214OS	8	77224OGS	8
75784	18	76067	41	76846	39	77027	40	77214T3GS	7	77224OS	8
75785	18	76068	41	76847	39	77028	40	77214T3S	7	77224T3GS	7
75786	18	76069	41	76848	39	77029	40	77214TGS	7	77224T3S	7
75787	18	76071	41	76849	39	77030EGS	14	77214TS	7	77224TGS	7
75790	18	76072	41	76850	39	77030ES	14	77215E3GS	7	77224TS	7
75791	18	76073	41	76851	39	77030TGS	14	77215E3S	7	77225HE3GS	7
75792	18	76074	41	76852	39	77030TS	14	77215EGS	7	77225HE3S	7
75793	18	76075	41	76853	39	77031	40	77215ES	7	77225HEGS	7
75794	18	76076	41	76854	39	77032	40	77215LGS	8	77225HES	7
75795	18	76077	41	76855	39	77040EGS	14	77215LS	8	77225HLGS	8
75796	18	76078	41	76856	39	77040ES	14	77215OGS	8	77225HLS	8
75797	18	76079	41	76857	39	77040TGS	14	77215OS	8	77225HOGS	8
75798	18	76081	41	76858	39	77040TS	14	77215T3GS	7	77225HOS	8
75799	18	76082	41	76860	39	77060EGS	14	77215T3S	7	77225HT3GS	7
75825	18	76502	25	76861	39	77060ES	14	77215TGS	7	77225HT3S	7
75826	18	76524	25	76862	39	77060TGS	14	77215TS	7	77225HTGS	7
75827	18	76541	25	76863	39	77060TS	14	77216E3GS	7	77225HTS	7
75829	18	76587	28	76864	39	77080EGS	14	77216E3S	7	77230HE3GS	7
75830	18	76757	36	76865	39	77080ES	14	77216EGS	7	77230HE3S	7
75832	18	76758	36	76866	39	77080TGS	14	77216ES	7	77230HEGS	7
75840	36	76759	36	76867	39	77080TS	14	77216LGS	8	77230HES	7
75841	36	76800	30	76868	39	77210E3GS	7	77216LS	8	77230HLGS	8
75842	36	76801	30	76870	39	77210E3S	7	77216OGS	8	77230HLS	8
75843	36	76802	30	76871	39	77210EGS	7	77216OS	8	77230HOGS	8
75845	36	76803	30	77001	40	77210ES	7	77216T3GS	7	77230HOS	8
75846	36	76804	30	77002	40	77210LGS	8	77216T3S	7	77230HT3GS	7
75847	36	76805	30	77003	40	77210LS	8	77216TGS	7	77230HT3S	7
75848	36	76806	30	77004	40	77210OGS	8	77216TS	7	77230HTGS	7
75849	36	76807	30	77005	40	77210OS	8	77218E3GS	7	77230HTS	7
75850	36	76808	30	77006	40	77210T3GS	7	77218E3S	7	77240HE3GS	7
75851	36	76809	30	77007	40	77210T3S	7	77218EGS	7	77240HE3S	7
75852	36	76810	30	77008	40	77210TGS	7	77218ES	7	77240HEGS	7
75853	36	76811	30	77009	40	77210TS	7	77218OGS	8	77240HES	7
75901	34	76812	30	77010	40	77212E3GS	7	77218OS	8	77240HLGS	8
75902	34	76813	30	77010EGS	14	77212E3S	7	77218T3GS	7	77240HLS	8
75903	34	76814	30	77010ES	14	77212EGS	7	77218T3S	7	77240HOGS	8
75904	34	76815	30	77010TGS	14	77212ES	7	77218TGS	7	77240HOS	8
75905	34	76816	30	77010TS	14	77212LGS	8	77218TS	7	77240HT3GS	7
75906	34	76817	30	77011	40	77212LS	8	77220HE3GS	7	77240HT3S	7
75907	34	76818	30	77012	40	77212OGS	8	77220HE3S	7	77240HTGS	7
75908	34	76819	30	77012EGS	14	77212OS	8	77220HEGS	7	77240HTS	7
75909	34	76820	30	77012ES	14	77212T3GS	7	77220HES	7	77250E3GS	7
75910	34	76821	30	77012TGS	14	77212T3S	7	77220HLGS	8	77250E3S	7
75911	34	76822	25	77012TS	14	77212TGS	7	77220HLS	8	77250EGS	7
75912	34	76825	30	77013	40	77212TS	7	77220HOGS	8	77250ES	7
75913	34	76826	30	77014	40	77213E3GS	7	77220HOS	8	77250LGS	8
75914	34	76827	30	77015	40	77213E3S	7	77220HT3GS	7	77250LS	8
75915	34	76828	30	77016	40	77213EGS	7	77220HT3S	7	77250OGS	8
75916	34	76829	30	77017	40	77213ES	7	77220HTGS	7	77250OS	8
76051	41	76830	30	77018	40	77213LGS	8	77220HTS	7	77250T3GS	7
76052	41	76831	30	77019	40	77213LS	8	77221E3GS	7	77250T3S	7
76053	41	76832	30	77020EGS	14	77213OGS	8	77221E3S	7	77250TGS	7
76054	41	76833	30	77020ES	14	77213OS	8	77221EGS	7	77250TS	7
76055	41	76834	30	77020TGS	14	77213T3GS	7	77221ES	7	77260E3GS	7
76056	41	76835	30	77020TS	14	77213T3S	7	77221OGS	8	77260E3S	7

See latest catalog or technical data sheets for specific approvals, listings, and design parameters.  
 POA = Price on availability. Prices subject to change without notice.

**Customer Service: (800) 558-5236**

# Tyco Mechanical Products

## Section 15 – Indices



Part No. ....	Page	Part No. ....	Page	Part No. ....	Page	Part No. ....	Page	Part No. ....	Page	Part No. ....	Page
77260EGS	7	78060EPDME	95	90910EGS	76	909560EPDME	102	91430F	79	92480F	79
77260ES	7	78060ES	15	90910EPDME	101	909560ES	90	91430GF	79	92480GF	79
77260LGS	8	78060GES	15	90910ES	76	909580EPDME	102	91440F	79	92710F	78
77260LS	8	78060GTS	15	90910NITRILS	101	909580ES	90	91440GF	79	92710GF	78
77260OGS	8	78060NITRILS	95	90910TGS	76	90960EGS	76	91460F	79	92712F	78
77260OS	8	78060TES	15	90910TS	76	90960EPDME	101	91460GF	79	92712GF	78
77260T3GS	7	78080EPDME	95	90912EPDME	101	90960ES	76	91480F	79	92720F	78
77260T3S	7	78080ES	15	90912NITRILS	101	90960NITRILS	101	91480GF	79	92720GF	78
77260TGS	7	78080GES	15	90914EPDME	101	90960TGS	76	91910F	78	92725F	78
77260TS	7	78080GTS	15	90914NITRILS	101	90960TS	76	91910GF	78	91925GF	78
77280E3GS	7	78080NITRILS	95	90916EPDME	101	909710EPDME	102	91912F	78	92730F	78
77280E3S	7	78080TES	15	90916NITRILS	101	909710ES	91	91912GF	78	92730GF	78
77280EGS	7	79008	76	90918EGS	76	909712EPDME	102	91920F	78	92740F	78
77280ES	7	79008G	76	90918EPDME	101	909712ES	91	91920GF	78	92740GF	78
77280LGS	8	79008GT	76	90918ES	76	909720EPDME	102	91925F	78	92760F	78
77280LS	8	79008T	76	90918NITRILS	101	909720ES	91	91925GF	78	92760GF	78
77280OGS	8	79009	76	90918TGS	76	909730EPDME	102	91930F	78	92780F	78
77280OS	8	79009G	76	90918TS	76	909730ES	91	91930GF	78	92780GF	78
77280T3GS	7	79009GT	76	90920EGS	76	909740EPDME	102	91940F	78	94120F	81
77280T3S	7	79009T	76	90920EPDME	101	909740ES	91	91940GF	78	94120GF	81
77280TGS	7	79010	76	90920ES	76	909760EPDME	102	91960F	78	94125F	81
77280TS	7	79010G	76	90920NITRILS	101	909760ES	91	91960GF	78	94125GF	81
78001EPDME	95	79010GT	76	90920TGS	76	909780EPDME	102	91980F	78	94130F	81
78001NITRILS	95	79010T	76	90920TS	76	909780ES	91	91980GF	78	94130GF	81
78013EPDME	95	79011	76	90925EGS	76	90980EGS	76	9211040F	82	94140F	81
78013ES	15	79011G	76	90925EPDME	101	90980EPDME	101	9211040GF	82	94140GF	81
78013GES	15	79011GT	76	90925ES	76	90980ES	76	9211060F	82	94160F	81
78013GTS	15	79011T	76	90925NITRILS	101	90980NITRILS	101	9211060GF	82	94160GF	81
78013NITRILS	95	8060EPDME	95	90925TGS	76	90980TGS	76	9211080F	82	94180F	81
78013TES	15	8060NITRILS	95	90925TS	76	90980TS	76	9211080GF	82	94180GF	81
78015EPDME	95	80EN3	99	90930EGS	76	91010F	77	9213020F	82	94220F	82
78015ES	15	80EPDME	92	90930EPDME	101	91010GF	77	9213020GF	82	94220GF	82
78015GES	15	80EPDME3	92	90930ES	76	91012F	77	9214020F	82	94225F	82
78015GTS	15	80FLUORO	93	90930NITRILS	101	91012GF	77	9214020GF	82	94225GF	82
78015NITRILS	95	80FLUORO3	94	90930TGS	76	91020F	77	9214025F	82	94230F	82
78015TES	15	80NITRILS	92	90930TS	76	91020GF	77	9214025GF	82	94230GF	82
78020EPDME	95	80NITRILS3	92	90940EGS	76	91020LF	77	9214030F	82	94240F	82
78020ES	15	80SILICONE	93	90940EPDME	101	91020LGF	77	9214030GF	82	94240GF	82
78020GES	15	90110F	77	90940ES	76	91025F	77	9216020F	82	94260F	82
78020GTS	15	90110GF	77	90940NITRILS	101	91025GF	77	9216020GF	82	94260GF	82
78020NITRILS	95	90112F	77	90940TGS	76	91025LF	77	9216030F	82	94280F	82
78020TES	15	90112GF	77	90940TS	76	91025LGF	77	9216030GF	82	94280GF	82
78025EPDME	95	90120F	77	909440EPDME	102	91030F	77	9216040F	82	96010F	79
78025ES	15	90120GF	77	909440ES	90	91030GF	77	9216040GF	82	96010GF	79
78025GES	15	90120LF	78	909460EPDME	102	91030LF	77	9218020F	82	96012F	79
78025GTS	15	90120LGF	78	909460ES	90	91030LGF	77	9218020GF	82	96012GF	79
78025NITRILS	95	90125F	77	909480EPDME	102	91040F	77	9218030F	82	96020F	79
78025TES	15	90125GF	77	909480ES	90	91040GF	77	9218030GF	82	96020GF	79
78030EPDME	95	90125LF	78	909510EPDME	102	91040LF	77	9218040F	82	96025F	79
78030ES	15	90125LGF	78	909510ES	90	91040LGF	77	9218040GF	82	96025GF	79
78030GES	15	90130F	77	909512EPDME	102	91060F	77	9218060F	82	96030F	79
78030GTS	15	90130GF	77	909512ES	90	91060GF	77	9218060GF	82	96030GF	79
78030NITRILS	95	90130LF	78	909514EPDME	102	91060LF	77	92410F	79	96040F	79
78030TES	15	90130LGF	78	909514ES	90	91060LGF	77	92410GF	79	96040GF	79
78040EPDME	95	90140F	77	909516EPDME	102	91080F	77	92412F	79	96060F	79
78040ES	15	90140GF	77	909516ES	90	91080GF	77	92412GF	79	96060GF	79
78040GES	15	90140LF	78	909518EPDME	102	91080LF	77	92420F	79	96080F	79
78040GTS	15	90140LGF	78	909518ES	90	91080LGF	77	92420GF	79	96080GF	79
78040NITRILS	95	90160F	77	909520EPDME	102	91410F	79	92425F	79	964020EN3	99
78040TES	15	90160GF	77	909520ES	90	91410GF	79	92425GF	79	964025EN3	99
78050EPDME	95	90160LF	78	909521EPDME	102	91412F	79	92430F	79	964030EN3	99
78050ES	15	90160LGF	78	909521ES	90	91412GF	79	92430GF	79	964040EN3	99
78050GES	15	90180F	77	909530EPDME	102	91420F	79	92440F	79	964050EN3	99
78050GTS	15	90180GF	77	909530ES	90	91420GF	79	92440GF	79	964060EN3	99
78050NITRILS	95	90180LF	78	909540EPDME	102	91425F	79	92460F	79	964080EN3	99
78050TES	15	90180LGF	78	909540ES	90	91425GF	79	92460GF	79	99120F	80

Introduction
Couplings & Fittings
Mechanical Tees
Valves
Circuit Balancing Valves
Accessories
Copper Systems
Stainless Steel Systems
Plain End Systems
Stainless Steel G-PRESS
HDPE Systems
Gaskets & Spare Parts
Preparation Equipment
Miscellaneous
Indices

Customer Service: (800) 558-5236

[www.grinnell.com](http://www.grinnell.com)

See latest catalog or technical data sheets for specific approvals, listings, and design parameters.  
POA = Price on availability. Prices subject to change without notice.

Part No. ....	Page	Part No. ....	Page	Part No. ....	Page	Part No. ....	Page	Part No. ....	Page	Part No. ....	Page
99120GF	80	9998040F	80	B33314TG	48	BV83560	50	GOH30230	47	S85312	54
99125F	80	9998040GF	80	B33316EG	48	BV83560G	50	GOH30240	47	S85312G	54
99125GF	80	9998050F	80	B33316TG	48	CB8000501	52	GOH30250	47	S85320	54
99130F	80	9998050GF	80	B33318EG	48	CB8000751	52	GOH30260	47	S85320G	54
99130GF	80	9998060F	80	B33318TG	48	CB8000752	52	GOH30280	47	S85325	54
99140F	80	9998060GF	80	B33320EG	48	CB8001001	52	LH30220	47	S85325G	54
99140GF	80	B30210EG	46	B33320TG	48	CB8001002	52	LH30225	47	S85330	54
99160F	80	B30210GO	46	B33324EG	48	CB8001103	52	LH30230	47	S85330G	54
99160GF	80	B30210TG	46	B33324TG	48	CB8001104	52	LH30240	47	S85340	54
99180F	80	B30212EG	46	B4801651EL	75	CB8001203	52	LH30250	47	S85340G	54
99180GF	80	B30212GO	46	B4801651TL	75	CB8001204	52	LH30260	47	S85350	54
99220F	81	B30212TG	46	B48020EL	75	CB8001251	52	LH30280	47	S85350G	54
99220GF	81	B30220EG	46	B48020TL	75	CB8001252	52	NB10550	103	S85360	54
99225F	81	B30220EL	46	B48025EL	75	CB8001501	52	NB10650	103	S85360G	54
99225GF	81	B30220GO	46	B48025TL	75	CB8001502	52	NB12575	103	S85380	54
99230F	81	B30220LO	46	B48030EL	75	CB8002001	52	NB37225	103	S85380G	54
99230GF	81	B30220TG	46	B48030TL	75	CB8002002	52	NB50300	103	S85510	54
99240F	81	B30220TL	46	B48040EL	75	CB8002503	52	NB50362	103	S85510G	54
99240GF	81	B30225EG	46	B48040TL	75	CB8002504	52	NB62275	103	S85512	54
99260F	81	B30225EL	46	B48060EL	75	CB8003003	52	NB62325	103	S85512G	54
99260GF	81	B30225GO	46	B48060TL	75	CB8003004	52	NB62350	103	S85520	54
99280F	81	B30225LO	46	B480761EL	75	CB8004003	52	NB62450	103	S85520G	54
99280GF	81	B30225TG	46	B480761TL	75	CB8004004	52	NB62475	103	S85525	54
99320F	81	B30225TL	46	B810120E	50	CB8005002	52	NB75425	103	S85525G	54
99320GF	81	B30230EG	46	B810125E	50	CB8005003	52	NB75475	103	S85530	54
99325F	81	B30230EL	46	B810130E	50	CB8005004	52	NB87550	103	S85530G	54
99325GF	81	B30230GO	46	B810140E	50	CB8006003	52	NB87650	103	S85540	54
99330F	81	B30230LO	46	B810150E	50	CB8006004	52	NBSS10550	103	S85540G	54
99330GF	81	B30230TG	46	B810160E	50	CB8008003	52	NBSS10650	103	S85550	54
99340F	81	B30230TL	46	B820020	50	CB8008004	52	NBSS37225	103	S85550G	54
99340GF	81	B30240EG	46	B820030	50	CBBV025	53	NBSS50300	103	S85560	54
99360F	81	B30240EL	46	B820040	50	CBIS010	53	NBSS62325	103	S85560G	54
99360GF	81	B30240GO	46	B820060	50	CBIS050	53	NBSS62475	103	S85580	54
99380F	81	B30240LO	46	B820080	50	CBIS075	53	NBSS75475	103	S85580G	54
99380GF	81	B30240TG	46	BN30210EG	47	CBIS125	53	NBSS87650	103	TD83010	51
9992520F	80	B30240TL	46	BN30212EG	47	CBIS150	53	PT1000	104	TD83012	51
9992520GF	80	B30250EG	46	BN30220EG	47	CBIS200	53	S8101010	55	TD83014	51
9993020F	80	B30250EL	46	BN30220EL	47	CBIS250	53	S8101060	55	TD83020	51
9993020GF	80	B30250GO	46	BN30225EG	47	CBIS300	53	S8101080	55	TD83025	51
9993025F	80	B30250LO	46	BN30225EL	47	CBIS400	53	S8101210	55	TD83030	51
9993025GF	80	B30250TG	46	BN30230EG	47	CBIS500	53	S8101212	55	TD83040	51
9994020F	80	B30250TL	46	BN30230EL	47	CBIS600	53	S8101280	55	TD83050	51
9994020GF	80	B30260EG	46	BN30240EG	47	CBIS800	53	S8101410	55	TD83060	51
9994025F	80	B30260EL	46	BN30240EL	47	CBMA01	53	S8101412	55	TD83080	51
9994025GF	80	B30260GO	46	BN30250EG	47	CBMDMC2	53	S8101414	55		
9994030F	80	B30260LO	46	BN30250EL	47	CBSE2560	53	S8101614	55		
9994030GF	80	B30260TG	46	BN30260EG	47	CBSE7520	53	S8103020	55		
9995020F	80	B30260TL	46	BN30260EL	47	CBSR100	53	S8103025	55		
9995020GF	80	B30280EG	46	BN30280EG	47	CBTK02	53	S8103030	55		
9995030F	80	B30280EL	46	BN30280EL	47	CBTP02	53	S8104020	55		
9995030GF	80	B30280GO	46	BV43515	75	CBTPX80	53	S8104025	55		
9995040F	80	B30280LO	46	BV43520	75	CV89014E	51	S8104030	55		
9995040GF	80	B30280TG	46	BV43525	75	CV89014T	51	S8104040	55		
9996020F	80	B30280TL	46	BV43530	75	CV89016E	51	S8105030	55		
9996020GF	80	B30814ENG	48	BV43540	75	CV89016T	51	S8105040	55		
9996025F	80	B30814TNG	48	BV83515	50	CV89018E	51	S8105050	55		
9996025GF	80	B30816ENG	48	BV83515G	50	CV89018T	51	S8106030	55		
9996030F	80	B30816TNG	48	BV83520	50	CV89020E	51	S8106040	55		
9996030GF	80	B30818ENG	48	BV83520G	50	CV89020T	51	S8106050	55		
9996040F	80	B30818TNG	48	BV83525	50	CV89024E	51	S8106060	55		
9996040GF	80	B30820ENG	48	BV83525G	50	CV89024T	51	S8108050	55		
9996050F	80	B30820TNG	48	BV83530	50	GOH30210	47	S8108060	55		
9996050GF	80	B30824ENG	48	BV83530G	50	GOH30212	47	S8108080	55		
9998030F	80	B30824TNG	48	BV83540G	50	GOH30220	47	S85310	54		
9998030GF	80	B33314EG	48	BV83540M	50	GOH30225	47	S85310G	54		

See latest catalog or technical data sheets for specific approvals, listings, and design parameters.  
 POA = Price on availability. Prices subject to change without notice.

Customer Service: (800) 558-5236

[www.grinnell.com](http://www.grinnell.com)

<b>Model No.</b>	<b>Page</b>	<b>Model No.</b>	<b>Page</b>
#61H Flange Adapter – Hinged .....	59	#380 Female Thread Adapter, Groove x Female Pipe Thread ...	32
#71 Flange Adapter Replacement .....	96	#391 Groove x Male Thread – Adapter Nipple .....	30
#71 Flange Washer Adapter, Carbon Steel or Stainless Steel...	96	#392 Groove x Groove – Adapter Nipple .....	31
#71 Grooved Flange Adapter .....	16	#393 Groove x Beveled – Adapter Nipple .....	31
#71 Nut, Bolt, and Gasket Kit .....	103	#395 Hose Adapter Nipple, Groove x Hose .....	31
#71H Grooved Flange Adapter - Hinged .....	15	#397 Groove x Groove – Swaged Nipple .....	39
#71H Grooved Flange Adapter - Hinged .....	15	#398 Groove x Male Thread – Swaged Nipple .....	40
#71H Hinged Flange Adapter Replacement Gasket.....	96	#399 Groove x Plain – Swaged Nipple .....	41
#201 Grooved 45° Elbow.....	16	#401 45° Elbow, 304 SS & 316 SS, Schedule 10.....	66
#201LR and #301LR – Grooved 45° Long Radius Elbow .....	18	#401 45° Elbow, Long Radius, 304SS & 316SS, Sch. 40.....	71
#210 Grooved 90° Elbow.....	16	#405 Flexible Coupling 316 SS .....	65
#210LR and #310LR – Grooved 90° Long Radius Elbow .....	18	#405 Flexible Coupling 316 SS with Tri-Seal Gasket .....	65
#211 and #311 – Grooved 11-1/4° Elbow.....	17	#407 G-PRESS 316 Stainless Steel Coupling.....	83
#212 and #312 – Grooved 22-1/2° Elbow.....	17	#407GG Dielectric Waterway Transition Fitting .....	62
#219 and #319 – Grooved Tee .....	23	#407GT Dielectric Waterway Grooved x Thread .....	62
#221 and #321 – Grooved Reducing Tee .....	24-25	#407T Dielectric Waterway Male Thread x Male Thread .....	63
#250 and #350 – Grooved Concentric Reducer.....	27-28	#408 G-PRESS 316 Stainless Steel Slip Coupling.....	83
#251 and #351 – Grooved Eccentric Reducer .....	28-29	#410 90° Elbow 304 SS & 316 SS, Schedule 10 .....	66
#260 and #360 – Grooved Cap .....	36	#410 90° Elbow, Long Radius, 304 SS & 316 SS, Sch. 40 .....	71
#260 Cast – Grooved Cap with 3/4" Tap .....	37	#419 Tee, 304 SS & 316 SS, Schedule 10 .....	67
#301 -3D, #301 - 5D, #301 -6D, Long Radius 45° Elbow .....	20	#419 Tee, 304 SS & 316 SS, Schedule 40 .....	72
#303 - 3D, #303 - 5D, #303 - 6D, Long Radius 30° Elbow.....	20	#421 Reducing Tee, 304 SS & 316 SS, Schedule 10 .....	68
#306 - 3D, #306 - 5D, #306 - 6D, Long Radius 60° Elbow.....	19	#421 Reducing Tee, 304 SS & 316 SS, Schedule 40 .....	72
#310 - 3D, #310 - 5D, #310 - 6D Long Radius 90° Elbow.....	19	#441 Flange Adapter Nipple 150 lbs. 304 SS & 316 SS, Schedule 10.....	68
#311 - 3D, #311 - 5D, #311 - 6D, Long Radius 11-1/4° Elbow..	21	#442 G-PRESS 316 Stainless Steel Equal Tee .....	85
#312 3D, #312 - 5D, #312 - 6D, Long Radius 22-1/2° Elbow....	21	#450 Concentric Reducer, 304 SS & 316 SS, Schedule 10.....	69
#314 Grooved Lateral .....	32	#450 Concentric Reducer, 304 SS & 316 SS, Schedule 40.....	73
#315 Groove x Male Thread – Adapter 90° Elbow .....	22	#451 Eccentric Reducer, 304 SS & 316 SS, Schedule 10 .....	70
#316 Reducing Base Support Elbow, Groove x Flange .....	22	#451 Eccentric Reducer, 304 SS & 316 SS, Schedule 40 .....	74
#320 Groove x Male Thread – Tee .....	23	#460 Cap, 304 SS & 316 SS, Schedule 10 .....	67
#323 Groove x Male Thread – Reducing Tee with Threaded Branch .....	25-26	#461 G-PRESS 316 Stainless Steel Weld Adaptor .....	88
#324 Grooved Wye .....	34	#466 G-PRESS 316 Stainless Steel Flange Adapter Van Stone	89
#325 Grooved Reducing Lateral .....	33	#467 G-PRESS 316 Stainless Steel 90° Elbow.....	84
#327 – Grooved Cross .....	36	#468 G-PRESS 316 Stainless Steel 90° Elbow.....	83
#330 Grooved Tee Wye .....	35	#469 G-PRESS Stainless Steel Ball Valve.....	89
#331 Grooved Reducing Tee Wye .....	34	#470 G-PRESS 316 Stainless Steel 45° Elbow.....	84
#341 Groove x Flange – Adapter 150# .....	38	#471 G-PRESS 316 Stainless Steel 45° Elbow.....	84
#342 Groove x Flange – Adapter 300# .....	38	#472 Rigid Coupling 316 SS.....	64
#372 Groove x Male Thread – Reducer .....	30	#472 Rigid Coupling 316 SS with Tri-seal Gasket .....	64

Introduction
Couplings & Fittings
Mechanical Tees
Valves
Circuit Balancing Valves
Accessories
Copper Systems
Stainless Steel Systems
Plain End Systems
Stainless Steel G-PRESS
HDPE Systems
Gaskets & Spare Parts
Preparation Equipment
Miscellaneous
<b>Indices</b>

Model No. ....	Page	Model No. ....	Page
#473 G-PRESS 316 Stainless Steel Reducing Tee.....	85	#730 Mechanical Cross – Grooved .....	45
#474 G-PRESS 316 Stainless Steel Reducer.....	86	#730 Mechanical Cross – Threaded .....	44
#475 G-PRESS 316 Stainless Steel Flange Adapter .....	89	#730 Mechanical Tee – Grooved .....	43
#476 G-PRESS 316 Stainless Steel Adapter .....	87	#730 Mechanical Tee – Threaded.....	42
#477 G-PRESS 316 Stainless Steel Transition Nipple .....	88	#730 Replacement “E” EPDM Gasket .....	97
#478 G-PRESS 316 Stainless Steel Reducing Tee Adapter.....	86	#740 Rapid Installation Pivot-Bolt (GRIP) Rigid Coupling Center-Stop Push-On Style Gasket.....	6
#479 G-PRESS 316 Stainless Steel .....	87	#7550 – Expansion Joint .....	56
#484 G-PRESS 316 Stainless Steel End Cap .....	88	#770 High Pressure Rigid Coupling.....	14
#485 G-PRESS 316 Stainless Steel Union .....	88	#772 Rigid Coupling.....	7
#590 Grooved Check Valve .....	51	#772 Rigid Coupling with Tri-Seal Gasket .....	7
#601 Grooved 45° Elbow.....	60	#772 Rigid Coupling with Grade “L” Silicone Gasket.....	8
#61 Flange Adapter.....	59	#772 Rigid Coupling with Grade “O” Fluoroelastomer Gasket...8	
#610 Grooved 90° Elbow.....	60	#780 Snap Coupling .....	15
#616 Reducing Coupling .....	58	#901 Plain End 45° Elbow .....	77
#617 Transition Coupling for Joining IPS to Copper Tubing Systems.....	59	#901LR Plain End Long Radius 45° Elbow .....	78
#618 Reducing Tee Grooved x Grooved x Cup .....	62	#909 Plain End Coupling .....	76
#619 Tee .....	60	#9094 HDPE Flange Coupling.....	90
#621 Reducing Tee.....	61	#9095 HDPE Coupling.....	90
#640 Pivot-Bolt Rigid Couplings Center-Stop Push-On Style Gasket .....	58	#9097 HDPE Transition Coupling.....	91
#650 Grooved Concentric Reducer .....	61	#910 Plain End 90° Elbow .....	77
#652 Grooved Reducer Grooved x Cup.....	61	#910LR Plain End Long Radius 90° Elbow .....	77
#660 Cap.....	60	#914 Plain End Lateral .....	79
#672 Rigid Couplings .....	58	#919 Plain End Tee .....	78
#702 Outlet Coupling Grade “E” Gasket, Female Threaded End .....	13	#921 Reducing Tee Plain End .....	82
#702 Outlet Coupling Grade “E” Gasket, Grooved End .....	14	#924 Plain End True Wye.....	79
#702 Outlet Coupling Grade “E” Gasket, Male Threaded End ..	14	#927 Plain End Cross .....	78
#705 Flexible Coupling .....	9	#941 Flange Adapter 150 lbs. ....	81
#705 Flexible Coupling with Tri-Seal Gasket.....	9	#942 Flange Adapter 300 lbs. ....	82
#705 Flexible Coupling with Grade “L” Silicone Gasket.....	10	#960 Plain End Cap (Bull Plug) .....	79
#705 Flexible Coupling with Grade “O” Fluoroelastomer Gasket.....	10	#991 Adapter Nipple – Plain x Thread .....	80
#707 Heavy-Duty Flexible Coupling .....	11	#992 Adapter Nipple – Plain x Grooved.....	81
#707 Heavy-Duty Flexible Coupling with Tri-Seal Gasket.....	11	#993 Adapter Nipple – Plain x Bevel.....	81
#707 Heavy-Duty Flexible Coupling, with Grade “L” Silicone or Grade “O” Fluoroelastomer Gasket.....	12	#999 Plain End Swaged Nipple .....	80
#707L Large Diameter Heavy-Duty Flexible Coupling .....	12	#B302 and #BN302 Grooved Butterfly Valve – Accessories ....	47
#716 Reducing Coupling .....	13	#B302 Grooved Butterfly Valve.....	46
		#B302 Grooved Butterfly Valve – Fluoroelastomer.....	46
		#B308 Grooved Butterfly Valve, – D.I. Nickle Plated, Gear Operator.....	48

See latest catalog or technical data sheets for specific approvals, listings, and design parameters.  
 POA = Price on availability. Prices subject to change without notice.

Model No. ....	Page	Model No. ....	Page
#B480 Stainless Steel Grooved Butterfly Valve, Lever Operator.....	75	Pipe Tape Chrome Plated with GRINNELL Logo.....	104
#B680 Copper System Butterfly Valve Grooved .....	63	Replacement Gaskets – For #772, #770, #705, #707 .....	92
#B8101 Low Profile Butterfly Valve with Lever Handle .....	50	Replacement Gaskets – For #616 Reducing Coupling.....	99
#B8200L Grooved Butterfly Valve – EPDM (For Use In PVC Piping Systems).....	50	Replacement Gaskets – For #617 Transition Coupling .....	100
#BN302 Grooved Butterfly Valve – NSF Approved .....	47	Replacement Gaskets – For #640 Coupling.....	99
#CB800 Circuit Balancing Valves – Accessories.....	53	Replacement Gaskets – For #61 Flange Adapter .....	100
#CB800 Flange x Flange – Circuit Balancing Valve .....	52	Replacement Gaskets – For #61H Flange Adapter - Hinged... 100	
#CB800 Groove x Groove – Circuit Balancing Valve .....	52	Replacement Gaskets – Grade “EN” Tri-Seal (for #672 Coupling) .....	99
#CB800 Solder x Solder – Circuit Balancing Valve .....	52	Replacement Gaskets – For # 716 Reducing Coupling .....	95
#CB800 Thread x Thread – Circuit Balancing Valve .....	52	Replacement Gaskets – For #780 Snap Coupling .....	95
#CV890 Grooved Dual Disk Check Valve.....	51	Replacement Gaskets – For #702 Outlet Coupling .....	98
#S810 Groove x Flange ANSI – Suction Diffuser .....	55	Replacement Gaskets – For #909 Plain End Coupling .....	101
#S853 Grooved Wye Strainer .....	54	Replacement Gaskets Grade “L” Silicone Gasket .....	93
#S855 Grooved Tee – Type Strainer .....	54	Replacement Gaskets Grade “O” Fluoroelastomer Gasket.....	93
#TD830, Triple Duty Valve, Flow Control Type.....	51	Replacement Gaskets – For #740 Rapid Installation Pivot-Bolt (GRIP) Rigid Coupling .....	98
Accessories.....	105	Replacement Tri-Seal Gaskets – For #772, #770, #705, #707 .92	
Babbitt Valve Chainwheels.....	49	Replacement Tri-Seal Gaskets Grade “O” Fluoroelastomer Gasket .....	94
BV435 Stainless Steel Grooved Ball Valve (600 psi).....	75	Roll Groover Mini-Mite, Copper Tube #1039-66 .....	63
BV835 Grooved Ball Valve .....	50	Roll Grooving Machine Selection Chart .....	105
Copper System Grooved Couplings – Pieces Per Carton/Case.....	109	Roll Selection Chart.....	106
Coupling Nut and Bolt Kit.....	103	Table of Contents.....	2
Differential Measuring Computer.....	53		
G-PRESS Stainless Steel O-Rings .....	89		
GRINNELL Gasket Lubricant.....	104		
GRINNELL Gasket Styles, Grades and Recommendations .....	5		
GRINNELL Silicone Gasket Lubricant .....	104		
Grooved Couplings – Pieces Per Carton/Case.....	107		
Grooved Fittings – Pieces Per Carton/Case .....	107		
Grooved Fittings – Pieces Per Carton/Case .....	108		
Grooved Fittings – Pieces Per Carton/Case .....	109		
HDPE – #9094 Replacement Gaskets “E” .....	102		
HDPE – #9095 Replacement Gaskets “E” .....	102		
HDPE – #9097 Replacement Gaskets “E” .....	102		
Insulation Kits for #CB800 Circuit Balancing Valves.....	53		
Model B333 Grooved Butterfly Valve, EPDM or Nitrile, Gear Operator .....	48		
Part Number Changes - Cross Reference.....	110		
Phenolic Washer (for #61 Flange Adapter).....	101		

Introduction
Couplings & Fittings
Mechanical Tees
Valves
Circuit Balancing Valves
Accessories
Copper Systems
Stainless Steel Systems
Plain End Systems
Stainless Steel G-PRESS
HDPE Systems
Gaskets & Spare Parts
Preparation Equipment
Miscellaneous
Indices

**Customer Service: (800) 558-5236**  
**www.grinnell.com**

*See latest catalog or technical data sheets for specific approvals, listings, and design parameters.  
 POA = Price on availability. Prices subject to change without notice.*



## Global Strength. Local Expertise. At your service.

---

### Global Headquarters

#### United States of America

1400 Pennbrook Parkway  
Lansdale, PA 19446  
Tel: +800 558 5236  
Fax: +800 877 1295

#### United States of America

1802 S.W. 2nd Street  
Pompano Beach, FL 33069  
Tel: +954 781 0866  
Fax: +954 781 9330

#### Mexico

Av. Presidente Juarez 2007 Lote 6  
San Jeronimo Tepetlaco,  
Tlalnepantla, Estado de México  
Mexico 54090  
Tel: +525 55 321 2350  
Fax: +525 55 321 2358

#### Singapore

2 Serangoon North Avenue 5  
#07-01  
Singapore 554911  
Tel: +65 6577 4360  
Fax: +65 6481 8791  
Email: info.apac@tycofp.com

#### Australia

Level 3, 95 Coventry Street  
Southbank, VIC 3006  
Australia  
Tel: +1 300 725 688 (Local)  
Fax: +1 300 720 733  
Tel: +61 3 9313 9700 (Int'l)  
Fax: +61 3 9313 9709  
Email: info.aust@tycofp.com

#### The Netherlands

Kopersteden 1  
P.O. Box 198  
7500 AD Enschede  
Tel: +31 0 53 428 4444  
Fax: +31 0 53 428 3377

#### United Arab Emirates

PO Box 61355  
Warehouse TB01, R/A 8  
Jebel Ali Free Zone, Dubai  
Tel: +971 4 883 8689  
Fax: +971 4 883 8674

#### India

1001, Wing 'C', 10th Floor  
Godrej Coliseum, Sion  
Mumbai 400022, India  
Tel: +91 22 6131 0600  
Fax: +91 22 6741 7405  
Email: info.india@tycofp.com

#### Shanghai

2F, Building No.1  
Lane 955, Jinhai Road  
Pudong, Shanghai 201206  
Tel: +86 21 6163 3373  
Fax: +86 21 6163 3371  
Email: info.china@tycofp.com

#### Hong Kong

Units 905-923, 9/F, Trade Square  
681 Cheung Sha Wan Road  
Cheung Sha Wan, Kowloon  
Hong Kong  
Tel: +852 2753 3524  
Fax: +852 2505 5826  
Email: info.china@tycofp.com

[www.grinnell.com](http://www.grinnell.com)

GRINNELL is a mark and/or registered trademark of Tyco International Ltd.

© Copyright 2015 Tyco Fire Products LP. All rights reserved.

PB-GMAMERI-201506-02\_EN

**tyco**  
Mechanical Products