



Grinnell



Mechanical Products

U.S. List Prices
Effective May 2017

IMPORTANT NOTICE

Customer acknowledges and agrees that, in the absence of a previously executed agreement between the parties, products provided hereunder are provided pursuant to the TFPP General Terms and Conditions of Sale. **ATTENTION IS DIRECTED TO THE LIMITATION OF LIABILITY, WARRANTY, INDEMNITY AND OTHER CONDITIONS AVAILABLE AT:**

http://www.tycofsbp.com/TFPPTerms_of_Sale/

Table of Contents
Section 1 – Introduction

Table of Contents	2-4
GRINNELL Gasket Styles, Grades and Recommendations	5

Section 2 – Couplings and Fittings

#740 Rapid Installation Pivot-Bolt (GRIP) Rigid Coupling	6
#772 Rigid Coupling	7
#772 Rigid Coupling with Tri-Seal Gasket	7
#772 Rigid Coupling with Grade "L" Silicone Gasket	8
#772 Rigid Coupling with Grade "O" Fluoroelastomer Gasket	8
#705 Flexible Coupling	9
#705 Flexible Coupling with Tri-Seal Gasket	9
#705 Flexible Coupling with Grade "L" Silicone Gasket	10
#705 Flexible Coupling with Grade "O" Fluoroelastomer Gasket	10
#707 Heavy-Duty Flexible Coupling	11
#707 Heavy-Duty Flexible Coupling with Tri-Seal Gasket	11
#707 Heavy-Duty Flexible Coupling with Grade "L" or Grade "O" Gasket	12
#707L Large Diameter Heavy-Duty Flexible Coupling	12
#716 Reducing Coupling	13
#702 Outlet Coupling, Female Threaded End	13
#702 Outlet Coupling, Male Threaded End	14
#702 Outlet Coupling, Grooved End	14
#770 High Pressure Rigid Coupling	14
#780 Snap Coupling	15
#71H Grooved Flange Adapter - Hinged	15
#71 Grooved Flange Adapter	16
#210 Grooved 90° Elbow	16
#201 Grooved 45° Elbow	16
#212 and #312 – Grooved 22½° Elbow	17
#211 and #311 – Grooved 11¼° Elbow	17
#210LR and #310LR – Grooved 90° Long Radius Elbow	18
#201LR and #301LR – Grooved 45° Long Radius Elbow	18
#310 - 3D, #310 - 5D, #310 - 6D Long Radius 90° Elbow, Painted	19
#306 - 3D, #306 - 5D, #306 - 6D, Long Radius 60° Elbow, Painted	19
#301 - 3D, #301 - 5D, #301 - 6D, Long Radius 45° Elbow, Painted	20
#303 - 3D, #303 - 5D, #303 - 6D, Long Radius 30° Elbow, Painted	20
#312 - 3D, #312 - 5D, #312 - 6D, Long Radius 22½° Elbow, Painted	21
#311 - 3D, #311 - 5D, #311 - 6D, Long Radius 11¼° Elbow, Painted	21
#316 Reducing Base Support Elbow, Groove x Flange	22
#315 Groove x Male Thread – Adapter 90° Elbow	22
#219 and #319 – Grooved Tee	23
#320 Groove x Male Thread – Tee	23
#221 and #321 – Grooved Reducing Tee	24-25
#323 Groove x Male Thread – Reducing Tee with Threaded Branch	25-26
#250 and #350 – Grooved Concentric Reducer	27-28
#251 and #351 – Grooved Eccentric Reducer	28-29
#372 Groove x Male Thread – Reducer	30

**As used in this Table of Contents and Price Book, the designation "domestic" is meant to identify where the last point of manufacture or assembly takes place for a product. However, this designation does not represent compliance with any government regulatory standards or contract specifications and should not be relied upon for such purposes. You must request separate certifications or other representations concerning the specific regulatory standards or contract specifications which apply for your application.*

In order to request regulatory or specification certifications/ representations please contact Tyco Trade Compliance at 215-362-0700 for assistance. In your request, please identify the part numbers and specific regulatory standards or contract specifications about which you are inquiring.

See latest catalog or technical data sheets for specific approvals, listings, and design parameters.
 POA = Price on availability. Prices subject to change without notice.

Table of Contents

Section 2 – Couplings and Fittings (cont.)

#391 Groove x Male Thread – Adapter Nipple	30
#392 Groove x Groove – Adapter Nipple	31
#393 Groove x Beveled – Adapter Nipple	31
#395 Hose Adapter Nipple, Groove x Hose	31
#380 Female Thread Adapter, Groove x Female Pipe Thread	32
#314 Grooved Lateral	32
#325 Grooved Reducing Lateral	33
#324 Grooved Wye	34
#331 Grooved Reducing Tee Wye	34
#330 Grooved Tee Wye	35
#327 – Grooved Cross	36
#260 and #360 – Grooved Cap	36
#260 Cast – Grooved Cap with 1/2", 3/4", or 1" Tap	37
#341 Groove x Flange – Adapter 150#	38
#342 Groove x Flange – Adapter 300#	38
#397 Groove x Groove – Swaged Nipple	39
#398 Groove x Male Thread – Swaged Nipple	40
#399 Groove x Plain – Swaged Nipple	41

Section 3 – Mechanical Tees

#730 Mechanical Tee – Threaded	42
#730 Mechanical Tee – Grooved	43
#730 Mechanical Cross – Threaded	44
#730 Mechanical Cross – Grooved	45

Section 4 – Valves

#B303 Grooved Butterfly Valve – EPDM or Nitrile	46
#B303 Grooved Butterfly Valve – Fluoroelastomer	46
#B303 Grooved Butterfly Valve – Accessories	47
#B333 Grooved Butterfly Valve, EPDM or Nitrile, Gear Operator	48
Babbitt Valve Chainwheels	49
#B8101 Low Profile Butterfly Valve with Lever Handle	50
#BV835 Grooved Ball Valve	50
#B8200L Grooved Butterfly Valve – EPDM (For PVC Piping Systems)	50
#590 Grooved Check Valve, EPDM or Nitrile	51
#CV890 Grooved Dual Disk Check Valve, EPDM or Nitrile	51
#TD830, Triple Duty Valve, Flow Control Type	51

Section 5 – Circuit Balancing Valves

#CB800 Solder x Solder – Circuit Balancing Valve	52
#CB800 Thread x Thread – Circuit Balancing Valve	52
#CB800 Flange x Flange – Circuit Balancing Valve	52
#CB800 Groove x Groove – Circuit Balancing Valve	52
#CB800 Circuit Balancing Valves – Accessories	53
Insulation Kits for #CB800 Circuit Balancing Valves	53
Differential Measuring Computer	53

Table of Contents

Section 6 – Accessories

#S853 Grooved Wye Strainer	54
#S855 Grooved Tee – Type Strainer	54
#S810 Groove x Flange ANSI – Suction Diffuser	55
#7550 – Expansion Joint	56 - 57

Section 7 – Copper Systems

#640 Pivot-Bolt Rigid Couplings Center-Stop Push-On Style Gasket	58
#672 Rigid Couplings	58
#616 Reducing Coupling	58
#617 Transition Coupling for Joining IPS to Copper Tubing Systems	59
#61H Flange Adapter – Hinged	59
#61 Flange Adapter	59
#610 Grooved 90° Elbow	60
#601 Grooved 45° Elbow	60
#619 Tee	60
#660 Cap	60
#650 Grooved Concentric Reducer	61
#652 Grooved Reducer, Grooved x Cup	61
#621 Reducing Tee, Grooved x Grooved x Grooved	61
#618 Reducing Tee, Grooved x Grooved x Cup	62
#407GG Dielectric Waterway Transition Fitting, Grooved x Grooved	62
#407GT Dielectric Waterway, Grooved x Thread	62
#407T Dielectric Waterway, Male Thread x Male Thread	63
#B680 Copper System Butterfly Valve Grooved, EPDM	63
Roll Groover Mini-Mite 2" – 8" Copper Tube #1039-66	63

Section 8 – Stainless Steel Systems

#472 Rigid Coupling 316 SS	64
#472 Rigid Coupling 316 SS with Tri-seal Gasket	64
#405 Flexible Coupling 316 SS	65
#405 Flexible Coupling 316 SS with Tri-Seal Gasket	65
#410 90° Elbow, <i>Schedule 10</i>	66
#401 45° Elbow, <i>Schedule 10</i>	66
#419 Tee, <i>Schedule 10</i>	67
#460 Cap, <i>Schedule 10</i>	67
#421 Reducing Tee, <i>Schedule 10</i>	68
#441 Flange Adapter Nipple 150 lbs, <i>Schedule 10</i>	68
#450 Concentric Reducer, <i>Schedule 10</i>	69
#451 Eccentric Reducer, <i>Schedule 10</i>	70
#B480 Stainless Steel Grooved Butterfly Valve	71
#BV435 Stainless Steel Grooved Ball Valve (600 psi)	71

Introduction
Couplings & Fittings
Mechanical Tees
Valves
Circuit Balancing Valves
Accessories
Copper Systems
Stainless Steel Systems
Plain End Systems
Stainless Steel G-PRESS
HDPE Systems
Gaskets & Spare Parts
Preparation Equipment
Miscellaneous
Indices

**As used in this Table of Contents and Price Book, the designation "domestic" is meant to identify where the last point of manufacture or assembly takes place for a product. However, this designation does not represent compliance with any government regulatory standards or contract specifications and should not be relied upon for such purposes. You must request separate certifications or other representations concerning the specific regulatory standards or contract specifications which apply for your application.*
In order to request regulatory or specification certifications/ representations please contact Tyco Trade Compliance at 215-362-0700 for assistance. In your request, please identify the part numbers and specific regulatory standards or contract specifications about which you are inquiring.

Table of Contents
Section 9 – Plain-End Systems

#909 Plain End Coupling	72
#910 Plain End 90° Elbow	73
#910LR Plain End Long Radius 90° Elbow	73
#901 Plain End 45° Elbow	73
#901LR Plain End Long Radius 45° Elbow	74
#919 Plain End Tee	74
#927 Plain End Cross	74
#924 Plain End True Wye	75
#960 Plain End Cap (Bull Plug)	75
#914 Plain End Lateral	75
#999 Plain End Swaged Nipple	76
#991 Adapter Nipple – Plain x Thread	76
#992 Adapter Nipple – Plain x Grooved	77
#993 Adapter Nipple – Plain x Bevel	77
#941 Flange Adapter 150 lbs.	77
#942 Flange Adapter 300 lbs.	78
#921 Reducing Tee Plain End	78

**Section 10 – Stainless Steel
G-PRESS Systems**

#407 G-PRESS SS Coupling (Press x Press)	79
#408 G-PRESS SS Slip Coupling (Press x Press)	79
#468 G-PRESS SS 90° Elbow (Press x Press)	79
#467 G-PRESS SS 90° Elbow (Press x Fitting)	80
#471 G-PRESS SS 45° Elbow (Press x Press)	80
#470 G-PRESS SS 45° Elbow (Press x Fitting)	80
#442 G-PRESS SS Equal Tee (Press x Press x Press)	81
#473 G-PRESS SS Reducing Tee (Press x Press x Press)	81
#478 G-PRESS SS Reducing Tee Adapter (Press x Press x Female NPT)	82
#474 G-PRESS SS Reducer (Fitting x Press)	82
#476 G-PRESS SS Adapter (Press x Male NPT)	83
#479 G-PRESS SS (Press x Female NPT)	83
#484 G-PRESS SS End Cap (Press)	84
#461 G-PRESS SS Weld Adaptor (Fitting x Weld)	84
#477 G-PRESS SS Transition Nipple (Groove x Fitting)	84
#485 G-PRESS SS Union (Press x Press)	84
#475 G-PRESS SS Flange Adapter (Press x Flange)	85
#466 G-PRESS SS Flange Adapter Van Stone (Press x Flange)	85
#469 G-PRESS SS Ball Valve (Press x Press)	85
G-PRESS SS O-Rings	85

Section 11 – HDPE Systems

#9094 HDPE Flange Coupling	86
#9095 HDPE Coupling	86
#9097 HDPE Transition Coupling	87

Table of Contents
Section 12 – Gaskets & Spare Parts

Replacement Gaskets – For 772, 770, 705, 707.	88
Replacement Tri-Seal Gaskets – For 772, 770, 705, 707	88
Replacement Grade “L” Silicone Gasket – For 772, 770, 705, 707	89
Replacement Grade “O” Fluoroelastomer Gasket – For 772, 770, 705, 707	89
Replacement Tri-Seal Gaskets Grade “O” Fluoroelastomer Gasket For #772, #770, #705, #707	90
Replacement Gaskets For # 716 Reducing Coupling	91
Replacement Gaskets For #780 Snap Coupling	91
#71H Hinged Flange Adapter Replacement Gaskets	92
#71 Flange Adapter Replacement Gasket	92
#71 Flange Washer Adapter, Carbon Steel or Stainless Steel	92
Replacement Gaskets – For #730	93
Replacement Gaskets – For #702 Outlet Coupling	94
Replacement Gaskets – For #740 Pivot-Bolt (GRIP) Rigid Coupling	94
Replacement Gaskets – For #672 Coupling	95
Replacement Gaskets – For #640 Coupling	95
Replacement Gaskets – For #616 Reducing Coupling	95
Replacement Gaskets – For #617 Transition Coupling	96
Replacement Gaskets – For #61H Flange Adapter - Hinged	96
Replacement Gaskets – For #61 Flange Adapter	96
Phenolic Washer – For #61 Flange Adapter	97
Replacement Gaskets – For #909 Plain End Coupling	97
HDPE – #9094 Replacement Gaskets “E”	98
HDPE – #9095 Replacement Gaskets “E”	98
HDPE – #9097 Replacement Gaskets “E”	98
Coupling Nut and Bolt Kit	99
#71 Nut, Bolt, and Gasket Kit	99
Pipe Tape Chrome Plated with GRINNELL Logo	100
GRINNELL Gasket Lubricant	100
GRINNELL Silicone Gasket Lubricant	100

Section 13 – Preparation Equipment

Roll Grooving Machine Selection Chart	101
Accessories	101
Roll Selection Chart	102

Section 14 – Miscellaneous

Grooved Couplings – Pieces Per Carton/Case	103
Grooved Fittings – Pieces Per Carton/Case	103
Grooved Fittings – Pieces Per Carton/Case	104
Grooved Fittings – Pieces Per Carton/Case	105
Copper System Grooved Couplings – Pieces Per Carton/Case	105

Section 15 – Indices

Part Number Index	106 – 120
Model Number Index	121 – 123

**As used in this Table of Contents and Price Book, the designation “domestic” is meant to identify where the last point of manufacture or assembly takes place for a product. However, this designation does not represent compliance with any government regulatory standards or contract specifications and should not be relied upon for such purposes. You must request separate certifications or other representations concerning the specific regulatory standards or contract specifications which apply for your application.*

In order to request regulatory or specification certifications/ representations please contact Tyco Trade Compliance at 215-362-0700 for assistance. In your request, please identify the part numbers and specific regulatory standards or contract specifications about which you are inquiring.

See latest catalog or technical data sheets for specific approvals, listings, and design parameters.
 POA = Price on availability. Prices subject to change without notice.

GRINNELL Gasket Styles, Grades and Recommendations

Standard

The standard style gasket, with a “C” shape configuration, is the most commonly used. It is provided as the standard gasket in the Figure 705, 707, 770, 772, 405, and 472 GRINNELL Couplings. The gasket is available in Grade “E” and “EN” EPDM Grade “T” Nitrile, Grade “L” Silicone, and Grade “O” Fluoroelastomer.



Tri-Seal

The tri-seal gasket is designed to close off the gap or gasket cavity. This is accomplished by positioning the center “rib” of the gasket over the gap between the pipes.



The tri-seal gasket has two tapered sealing edges in addition to the center rib for additional strength and sealing. The Tri-Seal gasket can be used with the Figure 705, 707, 770, 772, 405, 472, and 672 GRINNELL Couplings. The gasket is available in Grade “E”, “EN” EPDM and Grade “T” Nitrile.

Note: Rigid couplings are recommended for vacuum and low temperature applications

Reducing Coupling

The reducing gasket is provided with ribs used to position the larger pipe so that the sealing lip is located on the sealing surface of the pipe. This gasket is used only with the Figure 716 GRINNELL Reducing Coupling and is available in Grade “E” EPDM and Grade “T” Nitrile.



Note: Reducing couplings are not recommended for low temperature applications.

Center-Stop Push-On

The Grade “EHT” EPDM Center-Stop, Push-On Style Gasket is specially designed for easy installation of the GRINNELL Figure 640 Pivot-Bolt Coupling.



Plain End Coupling

This gasket is designed for use with the Figure 909 and Figure 9095 Plain End Coupling.



Flange Adapter

This gasket is specifically designed for use with the Figure 71 and 61 Flange Adapter. The gasket has an optimal amount of rubber to provide a dependable seal between both the pipe and mating surface. The gasket is available in Grade “E” EPDM and Grade “T” Nitrile.

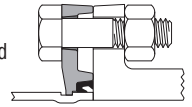

Mechanical Tee, Cross and Strap

The gasket provides a compression type seal, which is designed to conform to the exterior curve (OD) of the pipe.

This design is unique to both the Figure 730 Mechanical Tee (threaded and grooved) and Figure 40-5 Strap. The gasket is available in Grade “E” EPDM and Grade “T” Nitrile.

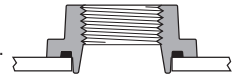

Note: When used in low temperature applications, use a petroleum-free silicone based lubricant, otherwise no lubricant is required on Mechanical Tee and Strap gaskets

Outlet Coupling

This gasket is specifically designed for use with the GRINNELL Figure 702 Outlet Coupling.

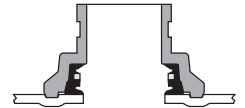

GRINNELL Gaskets are designed exclusively for use with GRINNELL manufactured coupling housings. The mixing of other manufacturer’s gaskets or housings with GRINNELL Gaskets or Housings may result in pipe joint leakage or failure and will void the Mechanical Products limited warranty.

The Gasket Recommendation Table has been developed to maximize service life. The table was developed from information supplied by the elastomer material manufacturers, reference technical literature, and testing conducted by Mechanical Products

In evaluating the gasket grade for intended service, consider the following: system operating temperature, fluid or solution concentration, and duration of service.

All gasket recommendations are based on a temperature of 70°F (21°C) unless otherwise noted.

When considering combinations of service solutions, consult Technical Services and Mechanical Services. (Phone 866-500-4768).

Mechanical Products for recommendations for services not listed.

Gasket recommendations apply to GRINNELL Gaskets and Valves only.

Grade	Temperature Range	Compound	Color Code	General Service Application
“E”	-30°F to 230°F (-34°C to 110°C)	EPDM	Green Striped	Hot water, dilute acids, alkalis, oil free air, and many chemical services not involving petroleum products. Excellent oxidation resistance. NOT FOR USE WITH HYDROCARBONS. NOT RECOMMENDED FOR STEAM SERVICE
“E” Tri-Seal	-30°F to 230°F (-34°C to 110°C)	EPDM	Green Striped	Hot water, dilute acids, alkalis, and many chemical services not involving petroleum products. Excellent oxidation resistance. NOT FOR USE WITH HYDROCARBONS. Recommended for low temperature and vacuum services.
“EN” and “EN” Tri-Seal IPS Pipe	Cold and Hot Potable Water up to 180°F (82°C)	EPDM	Green/Yellow Stripe	IPS Sizes Only , NSF 61 Approved for potable water. NOT RECOMMENDED FOR HYDROCARBONS.
“EN” Transition (IPS to CTS)	Cold and Hot Potable Water up to 180°F (82°C)	EPDM	Green/Copper Stripe	Transition from IPS to CTS sizes only. NSF 61 Approved for potable water.
“EN” Tri-Seal Copper Tubing	Cold and Hot Potable Water up to 180°F (82°C)	EPDM	Copper Striped	CTS Sizes Only , NSF 61 Approved for potable water. NOT RECOMMENDED FOR HYDROCARBONS.
“EHT” Center-Stop Push-On Style Copper Tubing	For closed-loop heating systems -30°F to 250°F (-34°C to 120°C) Potable Water up to 180°F (82°C)	EPDM	Red and Copper Striped	CTS Sizes Only , NSF 61 Approved for potable water. Recommended for use in low temperature and vacuum systems NOT RECOMMENDED FOR HYDROCARBONS.
“T” and “T” Tri-Seal	-20°F to 180°F (-29°C to 82°C)	Nitrile	Orange Striped	Petroleum products, vegetable oils, mineral oils and air with oils. High-End oil vapor temperature, decrease to 150°F (66°C) Not Recommended for Hot Water Systems. Not Recommended for Hot Dry Air Systems
“O”	+20°F to 300°F (-7°C to 149°C)	Fluoroelastomer	Blue Striped	Oxidizing acids, petroleum products, hydraulic fluids, lubricants, halogenated hydrocarbons.
“L”	-30°F to 350°F (-34°C to 177°C)	Silicone *	Red Gasket	Air without hydrocarbons, dry heat.

* To prevent gasket from deteriorating, NEVER use silicone-based lubricants with Grade “L” Silicone gaskets

Introduction
Couplings & Fittings
Mechanical Tees
Valves
Circuit Balancing Valves
Accessories
Copper Systems
Stainless Steel Systems
Plain End Systems
Stainless Steel G-PRESS
HDPE Systems
Gaskets & Spare Parts
Preparation Equipment
Miscellaneous
Indices

**#740 Rapid Installation Pivot-Bolt (GRIP) Rigid Coupling
 with Grade "EHT" EPDM or Grade "T" Nitrile Center-Stop Push-On Style Gasket**

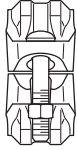
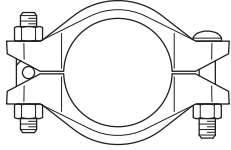

Nominal Size	Painted			Galvanized		
	Grade "EHT" EPDM	Grade "T" Nitrile	List Price	Grade "EHT" EPDM	Grade "T" Nitrile	List Price
2"	74020EHT	74020TS	\$81.50	74020EGHT	74020TGS	\$102.50
2½"	74025EHT	74025TS	\$93.00	74025EGHT	74025TGS	\$117.00
3"	74030EHT	74030TS	\$107.00	74030EGHT	74030TGS	\$136.50
4"	74040EHT	74040TS	\$149.00	74040EGHT	74040TGS	\$192.50
5"	74050EHT	74050TS	\$192.50	74050EGHT	74050TGS	\$250.50
6"	74060EHT	74060TS	\$252.50	74060EGHT	74060TGS	\$328.00
8"	74080EHT	74080TS	\$398.50	74080EGHT	74080TGS	\$518.00

Technical Data Sheet: G144

*All standard couplings can be provided with stainless steel nuts and bolts upon request.
 See latest catalog or technical data sheets for specific approvals, listings, and design parameters.
 POA = Price on availability. Prices subject to change without notice.*

Mechanical Products Section 2 – Couplings & Fittings



#772 Rigid Coupling with Grade "E" EPDM or Grade "T" Nitrile Gasket

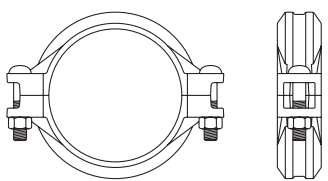

Nominal Size	Painted			Galvanized		
	Grade "E" EPDM	Grade "T" Nitrile	List Price	Grade "E" EPDM	Grade "T" Nitrile	List Price
1 1/4"	77213ES	77213TS	\$69.50	77213EGS	77213TGS	\$87.50
1 1/2"	77215ES	77215TS	\$74.50	77215EGS	77215TGS	\$93.50
2"	77220HES	77220HTS	\$81.50	77220HEGS	77220HTGS	\$102.50
2 1/2"	77225HES	77225HTS	\$93.00	77225HEGS	77225HTGS	\$117.00
3"	77230HES	77230HTS	\$107.00	77230HEGS	77230HTGS	\$136.50
4"	77240HES	77240HTS	\$149.00	77240HEGS	77240HTGS	\$192.50
5"	77250ES	77250TS	\$192.50	77250EGS	77250TGS	\$250.50
6"	77260ES	77260TS	\$252.50	77260EGS	77260TGS	\$328.00
8"	77280ES	77280TS	\$398.50	77280EGS	77280TGS	\$518.00
10"	77210ES	77210TS	\$772.50	77210EGS	77210TGS	\$1,030.00
12"	77212ES	77212TS	\$863.00	77212EGS	77212TGS	\$1,155.50
14"	77214ES	77214TS	\$938.50	77214EGS	77214TGS	\$1,155.50
16"	77216ES	77216TS	\$1,001.50	77216EGS	77216TGS	\$1,278.00
18"	77218ES	77218TS	\$1,157.00	77218EGS	77218TGS	\$1,499.00
20"	77221ES	77221TS	\$1,581.00	77221EGS	77221TGS	\$1,981.50
24"	77224ES	77224TS	\$2,027.00	77224EGS	77224TGS	\$2,567.50

Technical Data Sheet: G141

#772 Rigid Coupling with Grade "E" EPDM or Grade "T" Nitrile Tri-Seal Gasket

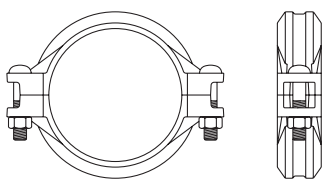

Nominal Size	Painted			Galvanized		
	Grade "E" EPDM	Grade "T" Nitrile	List Price	Grade "E" EPDM	Grade "T" Nitrile	List Price
1 1/4"	77213E3S	77213T3S	\$99.00	77213E3GS	77213T3GS	\$117.50
1 1/2"	77215E3S	77215T3S	\$105.50	77215E3GS	77215T3GS	\$125.50
2"	77220HE3S	77220HT3S	\$124.50	77220HE3GS	77220HT3GS	\$148.50
2 1/2"	77225HE3S	77225HT3S	\$149.00	77225HE3GS	77225HT3GS	\$174.50
3"	77230HE3S	77230HT3S	\$157.50	77230HE3GS	77230HT3GS	\$193.00
4"	77240HE3S	77240HT3S	\$220.00	77240HE3GS	77240HT3GS	\$271.00
5"	77250E3S	77250T3S	\$348.00	77250E3GS	77250T3GS	\$612.50
6"	77260E3S	77260T3S	\$410.00	77260E3GS	77260T3GS	\$501.50
8"	77280E3S	77280T3S	\$541.50	77280E3GS	77280T3GS	\$677.50
10"	77210E3S	77210T3S	\$1,084.00	77210E3GS	77210T3GS	\$1,376.00
12"	77212E3S	77212T3S	\$1,232.50	77212E3GS	77212T3GS	\$1,584.50
14"	77214E3S	77214T3S	\$938.50	77214E3GS	77214T3GS	\$1,155.50
16"	77216E3S	77216T3S	\$1,001.50	77216E3GS	77216T3GS	\$1,278.00
18"	77218E3S	77218T3S	\$1,157.00	77218E3GS	77218T3GS	\$1,499.00
20"	77221E3S	77221T3S	\$1,581.00	77221E3GS	77221T3GS	\$1,981.50
24"	77224E3S	77224T3S	\$2,027.00	77224E3GS	77224T3GS	\$2,567.50

Orders for items in shaded areas *cannot* be cancelled or returned.

Technical Data Sheet: G141

Introduction
Couplings & Fittings
Mechanical Tees
Valves
Circuit Balancing Valves
Accessories
Copper Systems
Stainless Steel Systems
Plain End Systems
Stainless Steel G-PRESS
HDPE Systems
Gaskets & Spare Parts
Preparation Equipment
Miscellaneous
Indices

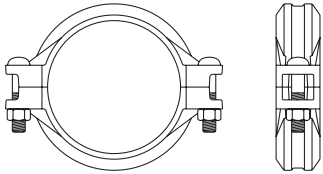
**#772 Rigid Coupling
 with Grade “L” Silicone Gasket**

<i>Nominal Size</i>	<i>Painted</i>	<i>List Price</i>	<i>Galvanized</i>	<i>List Price</i>
1¼"	77213LS	\$160.50	77213LGS	\$176.50
1½"	77215LS	\$228.50	77215LGS	\$246.50
2"	77220HLS	\$180.50	77220HLGS	\$202.50
2½"	77225HLS	\$205.00	77225HLGS	\$233.00
3"	77230HLS	\$230.50	77230HLGS	\$263.50
4"	77240HLS	\$341.50	77240HLGS	\$390.50
5"	77250LS	\$614.00	77250LGS	\$677.00
6"	77260LS	\$721.00	77260LGS	\$802.00
8"	77280LS	\$902.00	77280LGS	\$1,030.00
10"	77210LS	\$1,632.00	77210LGS	\$1,933.00
12"	77212LS	\$1,872.50	77212LGS	\$2,214.50
14"	77214LS	\$1,928.50	77214LGS	\$2,146.00
16"	77216LS	\$2,122.00	77216LGS	\$2,398.00

 Orders for items in shaded areas *cannot* be cancelled or returned.

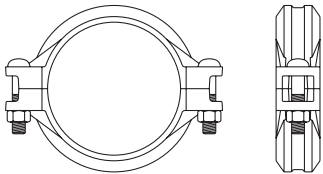
Technical Data Sheet: G141
**#772 Rigid Coupling
 with Grade “O” Fluoroelastomer Gasket**

<i>Nominal Size</i>	<i>Painted</i>	<i>List Price</i>	<i>Galvanized</i>	<i>List Price</i>
1¼"	772130S	\$434.50	772130GS	\$454.00
1½"	772150S	\$485.00	772150GS	\$504.50
2"	77220HOS	\$462.00	77220HOGS	\$484.00
2½"	77225HOS	\$519.50	77225HOGS	\$545.50
3"	77230HOS	\$580.00	77230HOGS	\$614.00
4"	77240HOS	\$949.50	77240HOGS	\$997.00
5"	772500S	\$1,034.50	772500GS	\$1,098.50
6"	772600S	\$1,300.00	772600GS	\$1,382.00
8"	772800S	\$1,578.50	772800GS	\$1,707.50
10"	772100S	\$2,677.50	772100GS	\$2,977.50
12"	772120S	\$3,706.50	772120GS	\$4,048.00
14"	772140S	POA	772140GS	POA
16"	772160S	POA	772160GS	POA
18"	772180S	POA	772180GS	POA
20"	772210S	POA	772210GS	POA
24"	772240S	POA	772240GS	POA

 Orders for items in shaded areas *cannot* be cancelled or returned.

Technical Data Sheet: G141

All standard couplings can be provided with stainless steel nuts and bolts upon request.
 See latest catalog or technical data sheets for specific approvals, listings, and design parameters.
 POA = Price on availability. Prices subject to change without notice.

Mechanical Products Section 2 – Couplings & Fittings



#705 Flexible Coupling with Grade "E" EPDM or Grade "T" Nitrile Gasket

Nominal Size	Painted			Galvanized		
	Grade "E" EPDM	Grade "T" Nitrile	List Price	Grade "E" EPDM	Grade "T" Nitrile	List Price
1 1/4"	70513ES	70513TS	\$55.50	70513EGS	70513TGS	\$72.00
1 1/2"	70515ES	70515TS	\$67.50	70515EGS	70515TGS	\$83.50
2"	70520ES	70520TS	\$82.00	70520EGS	70520TGS	\$107.50
2 1/2"	70525ES	70525TS	\$95.00	70525EGS	70525TGS	\$132.50
3"	70530ES	70530TS	\$105.50	70530EGS	70530TGS	\$145.50
4"	70540ES	70540TS	\$152.00	70540EGS	70540TGS	\$213.50
5"	70550ES	70550TS	\$228.50	70550EGS	70550TGS	\$328.00
6"	70560ES	70560TS	\$270.50	70560EGS	70560TGS	\$387.00
8"	70580ES	70580TS	\$438.50	70580EGS	70580TGS	\$651.50
10"	70510ES	70510TS	\$716.50	70510EGS	70510TGS	\$1,025.50
12"	70512ES	70512TS	\$814.00	70512EGS	70512TGS	\$1,165.50

Orders for items in shaded areas **cannot** be cancelled or returned.

* Items subject to minimum order quantities.

Technical Data Sheet: G110

#705 Flexible Coupling with Grade "E" EPDM or Grade "T" Nitrile Tri-Seal Gasket

Nominal Size	Painted			Galvanized		
	Grade "E" EPDM	Grade "T" Nitrile	List Price	Grade "E" EPDM	Grade "T" Nitrile	List Price
1 1/4"	70513E3S	70513T3S	\$90.00	70513E3GS	70513T3GS	\$107.00
1 1/2"	70515E3S	70515T3S	\$98.00	70515E3GS	70515T3GS	\$117.00
2"	70520E3S	70520T3S	\$101.00	70520E3GS	70520T3GS	\$120.50
2 1/2"	70525E3S	70525T3S	\$120.50	70525E3GS	70525T3GS	\$142.00
3"	70530E3S	70530T3S	\$127.00	70530E3GS	70530T3GS	\$153.00
4"	70540E3S	70540T3S	\$181.00	70540E3GS	70540T3GS	\$221.50
5"	70550E3S	70550T3S	\$307.00	70550E3GS	70550T3GS	\$365.50
6"	70560E3S	70560T3S	\$339.50	70560E3GS	70560T3GS	\$411.50
8"	70580E3S	70580T3S	\$563.50	70580E3GS	70580T3GS	\$675.50
10"	70510E3S	70510T3S	\$849.50	70510E3GS	70510T3GS	\$1,142.00
12"	70512E3S	70512T3S	\$997.50	70512E3GS	70512T3GS	\$1,313.50

Orders for items in shaded areas **cannot** be cancelled or returned.

Technical Data Sheet: G110

Introduction
Couplings & Fittings
Mechanical Tees
Valves
Circuit Balancing Valves
Accessories
Copper Systems
Stainless Steel Systems
Plain End Systems
Stainless Steel G-PRESS
HDPE Systems
Gaskets & Spare Parts
Preparation Equipment
Miscellaneous
Indices

**#705 Flexible Coupling
 with Grade “L” Silicone Gasket**

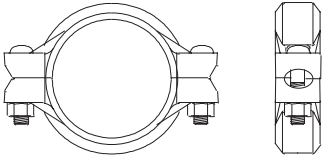
	<i>Nominal Size</i>	<i>Painted</i>	<i>List Price</i>	<i>Galvanized</i>	<i>List Price</i>
	1 1/4"	70513LS	\$205.50	70513LGS	\$222.00
	1 1/2"	70515LS	\$223.50	70515LGS	\$240.00
	2"	70520LS	\$149.00	70520LGS	\$165.50
	2 1/2"	70525LS	\$171.00	70525LGS	\$190.00
	3"	70530LS	\$189.00	70530LGS	\$213.50
	4"	70540LS	\$282.50	70540LGS	\$319.50
	5"	70550LS	\$529.50	70550LGS	\$581.50
	6"	70560LS	\$600.00	70560LGS	\$662.50
	8"	70580LS	\$739.50	70580LGS	\$850.50
	10"	70510LS	\$1,250.00	70510LGS	\$1,559.00
	12"	70512LS	\$1,447.50	70512LGS	\$1,799.00

 Orders for items in shaded areas **cannot** be cancelled or returned.

Technical Data Sheet: G110
**#705 Flexible Coupling
 with Grade “O” Fluoroelastomer Gasket**

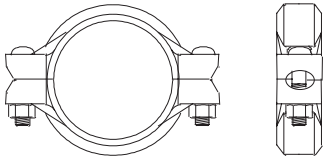
	<i>Nominal Size</i>	<i>Painted</i>	<i>List Price</i>
	1 1/4"	705130S	POA
	1 1/2"	705150S	POA
	2"	705200S	POA
	2 1/2"	705250S	POA
	3"	705300S	POA
	4"	705400S	POA
	5"	705500S	POA
	6"	705600S	POA
	8"	705800S	POA
	10"	705100S	POA
	12"	705120S	POA

 Orders for items in shaded areas **cannot** be cancelled or returned.

Technical Data Sheet: G110

All standard couplings can be provided with stainless steel nuts and bolts upon request.
 See latest catalog or technical data sheets for specific approvals, listings, and design parameters.
 POA = Price on availability. Prices subject to change without notice.

Mechanical Products Section 2 – Couplings & Fittings



#707 Heavy-Duty Flexible Coupling with Grade "E" EPDM or Grade "T" Nitrile Gasket

Nominal Size	Painted			Galvanized		
	Grade "E" EPDM	Grade "T" Nitrile	List Price	Grade "E" EPDM	Grade "T" Nitrile	List Price
1"	70701ES	70701TS	\$54.00	70701EGS	70701TGS	\$72.00
1½"	70715ES	70715TS	\$76.50	70715EGS	70715TGS	\$99.50
2"	70720ES	70720TS	\$82.00	70720EGS	70720TGS	\$107.50
2½"	70725ES	70725TS	\$95.00	70725EGS	70725TGS	\$132.50
3"	70730ES	70730TS	\$105.50	70730EGS	70730TGS	\$145.50
4"	70740ES	70740TS	\$152.00	70740EGS	70740TGS	\$213.50
5"	70750ES	70750TS	\$228.50	70750EGS	70750TGS	\$328.00
6"	70760ES	70760TS	\$270.50	70760EGS	70760TGS	\$387.00
8"	70780ES	70780TS	\$438.50	70780EGS	70780TGS	\$651.50
10"	70710ES	70710TS	\$714.00	70710EGS	70710TGS	\$1,022.50
12"	70712ES	70712TS	\$811.50	70712EGS	70712TGS	\$1,161.00
14"	70714ES	70714TS	\$1,160.00	70714EGS	70714TGS	\$1,600.50
16"	70716ES	70716TS	\$1,521.00	70716EGS	70716TGS	\$2,062.00
18"	70718ES	70718TS	\$1,780.00	70718EGS	70718TGS	\$2,465.50
20"	70721ES	70721TS	\$2,796.00	70721EGS	70721TGS	\$3,763.00
24"	70724ES	70724TS	\$3,064.00	70724EGS	70724TGS	\$4,114.50

Orders for items in shaded areas *cannot* be cancelled or returned.

Technical Data Sheet: G130

#707 Heavy-Duty Flexible Coupling with Grade "E" EPDM or Grade "T" Nitrile Tri-Seal Gasket

Nominal Size	Painted			Galvanized		
	Grade "E" EPDM	Grade "T" Nitrile	List Price	Grade "E" EPDM	Grade "T" Nitrile	List Price
1"	70701E3S	70701T3S	\$83.50	70701E3GS	70701T3GS	\$102.50
1½"	70715E3S	70715T3S	\$107.00	70715E3GS	70715T3GS	\$132.50
2"	70720E3S	70720T3S	\$112.00	70720E3GS	70720T3GS	\$140.00
2½"	70725E3S	70725T3S	\$136.00	70725E3GS	70725T3GS	\$173.00
3"	70730E3S	70730T3S	\$140.50	70730E3GS	70730T3GS	\$182.00
4"	70740E3S	70740T3S	\$202.50	70740E3GS	70740T3GS	\$265.00
5"	70750E3S	70750T3S	\$353.00	70750E3GS	70750T3GS	\$458.00
6"	70760E3S	70760T3S	\$392.00	70760E3GS	70760T3GS	\$513.50
8"	70780E3S	70780T3S	\$528.00	70780E3GS	70780T3GS	\$723.50
10"	70710E3S	70710T3S	\$847.00	70710E3GS	70710T3GS	\$1,138.00
12"	70712E3S	70712T3S	\$994.50	70712E3GS	70712T3GS	\$1,309.00
14"	70714E3S	70714T3S	\$1,296.00	70714E3GS	70714T3GS	\$1,716.50
16"	70716E3S	70716T3S	\$1,707.00	70716E3GS	70716T3GS	\$2,259.00
18"	70718E3S	70718T3S	\$2,003.50	70718E3GS	70718T3GS	\$2,704.50
20"	70721E3S	70721T3S	\$3,141.50	70721E3GS	70721T3GS	\$4,374.00
24"	70724E3S	70724T3S	\$3,536.50	70724E3GS	70724T3GS	\$4,612.50

Orders for items in shaded areas *cannot* be cancelled or returned.

Technical Data Sheet: G130

*All standard couplings can be provided with stainless steel nuts and bolts upon request.
See latest catalog or technical data sheets for specific approvals, listings, and design parameters.
POA = Price on availability. Prices subject to change without notice.*

**#707 Heavy-Duty Flexible Coupling, Painted*
 with Grade “L” Silicone or Grade “O” Fluoroelastomer Gasket**

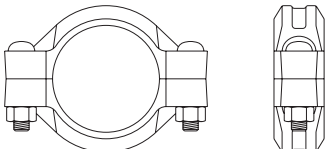
	Nominal Size	With Grade “L” Silicone Gasket		With Grade “O” Fluoroelastomer Gasket	
		Part Number	List Price	Part Number	List Price
	1½"	70715LS	\$232.00	70715OS	\$479.00
	2"	70720LS	\$161.50	70720OS	\$402.00
	2½"	70725LS	\$187.00	70725OS	\$453.50
	3"	70730LS	\$203.00	70730OS	\$503.50
	4"	70740LS	\$304.50	70740OS	\$825.50
	5"	70750LS	\$575.00	70750OS	\$935.00
	6"	70760LS	\$650.00	70760OS	\$1,147.00
	8"	70780LS	\$837.00	70780OS	\$1,417.50
	10"	70710LS	\$1,245.00	70710OS	\$2,006.50
	12"	70712LS	\$1,443.00	70712OS	\$2,777.00
	14"	70714LS	\$1,951.50	70714OS	POA
	16"	70716LS	\$2,160.00	70716OS	POA

* Galvanized available upon request.

Orders for items in shaded areas **cannot** be cancelled or returned.

Technical Data Sheet: G130

**#707L Large Diameter Heavy-Duty Flexible Coupling
 with Grade “E” EPDM or Grade “T” Nitrile Gasket**

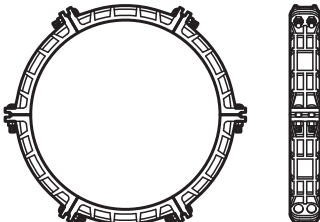
	Nominal Size	Painted			Galvanized		
		Grade “E” EPDM	Grade “T” Nitrile	List Price	Grade “E” EPDM	Grade “T” Nitrile	List Price
	26"	707L26ES	707L26TS	POA	707L26EGS	707L26TGS	POA
	28"	707L28ES	707L28TS	POA	707L28EGS	707L28TGS	POA
	30"	707L30ES	707L30TS	POA	707L30EGS	707L30TGS	POA
	32"	707L32ES	707L32TS	POA	707L32EGS	707L32TGS	POA
	36"	707L36ES	707L36TS	POA	707L36EGS	707L36TGS	POA
	40"	707L40ES	707L40TS	POA	707L40EGS	707L40TGS	POA
	42"	707L42ES	707L42TS	POA	707L42EGS	707L42TGS	POA

Orders for items in shaded areas **cannot** be cancelled or returned.

Technical Data Sheet: G133

All standard couplings can be provided with stainless steel nuts and bolts upon request.
 See latest catalog or technical data sheets for specific approvals, listings, and design parameters.
 POA = Price on availability. Prices subject to change without notice.

Mechanical Products Section 2 – Couplings & Fittings



#716 Reducing Coupling with Grade "E" EPDM Gasket or Grade "T" Nitrile Gasket

	Nominal Size	Painted			Galvanized		
		Grade "E" EPDM	Grade "T" Nitrile	List Price	Grade "E" EPDM	Grade "T" Nitrile	List Price
	2" x 1 1/2"	7162015ES	7162015TS	\$108.00	7162015EGS	7162015TGS	\$130.50
	2 1/2" x 2"	7162520ES	7162520TS	\$140.00	7162520EGS	7162520TGS	\$174.50
	3" x 2"	7163020ES	7163020TS	\$158.50	7163020EGS	7163020TGS	\$200.50
	3" x 2 1/2"	7163025ES	7163025TS	\$138.00	7163025EGS	7163025TGS	\$174.50
	4" x 2"	7164020ES	7164020TS	\$250.50	7164020EGS	7164020TGS	\$315.00
	4" x 2 1/2"	7164025ES	7164025TS	\$224.50	7164025EGS	7164025TGS	\$295.50
	4" x 3"	7164030ES	7164030TS	\$211.00	7164030EGS	7164030TGS	\$271.50
	5" x 4"	7165040ES	7165040TS	\$282.50	7165040EGS	7165040TGS	\$370.00
	6" x 4"	7166040ES	7166040TS	\$425.00	7166040EGS	7166040TGS	\$535.00
	6" x 5"	7166050ES	7166050TS	\$373.00	7166050EGS	7166050TGS	\$482.50
	8" x 6"	7168060ES	7168060TS	\$634.50	7168060EGS	7168060TGS	\$802.50

Technical Data Sheet: G120

#702 Outlet Coupling Grade "E" Gasket, Female Threaded End, Painted*

	Nominal Size	Grade "E" EPDM	List Price
	1 1/2" x 1/2"	7021505FES	\$143.00
	1 1/2" x 3/4"	7021575FES	\$143.00
	1 1/2" x 1"	7021501FES	\$143.00
	2" x 1/2"	7022005FES	\$145.50
	2" x 3/4"	7022075FES	\$145.50
	2" x 1"	7022001FES	\$145.50
	2 1/2" x 1/2"	7022505FES	\$223.50
	2 1/2" x 3/4"	7022575FES	\$223.50
	2 1/2" x 1"	7022501FES	\$223.50
	3" x 3/4"	7023075FES	\$215.00
	3" x 1"	7023001FES	\$285.00
	4" x 3/4"	7024075FES	\$315.00
	4" x 1"	7024001FES	\$315.00
	4" x 1 1/2"	7024015FES	\$446.50
	6" x 1"	7026001FES	\$630.50
	6" x 1 1/2"	7026015FES	\$630.50

* Galvanized available upon request.
Orders for items in shaded areas **cannot** be cancelled or returned.

Technical Data Sheet: G220

Introduction
Couplings & Fittings
Mechanical Tees
Valves
Circuit Balancing Valves
Accessories
Copper Systems
Stainless Steel Systems
Plain End Systems
Stainless Steel G-PRESS
HDPE Systems
Gaskets & Spare Parts
Preparation Equipment
Miscellaneous
Indices

#702 Outlet Coupling
Grade “E” Gasket, Male Threaded End, Painted*

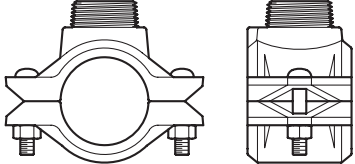
	Nominal Size	Grade “E” EPDM	List Price
	2" x 1"	7022001MES	\$145.50
	2½" x 1¼"	7022513MES	\$252.00
	2½" x 1½"	7022515MES	\$285.00
	3" x 1"	7023001MES	\$285.00
	3" x 1½"	7023015MES	\$326.50
	4" x 1"	7024001MES	\$315.00
	4" x 1½"	7024015MES	\$446.50
	4" x 2"	7024020MES	\$446.50
	6" x 1½"	7026015MES	\$630.50
6" x 2"	7026020MES	\$630.50	

* Galvanized available upon request.

 Orders for items in shaded areas **cannot** be cancelled or returned.

Technical Data Sheet: G220
#702 Outlet Coupling
Grade “E” Gasket, Grooved End, Painted*

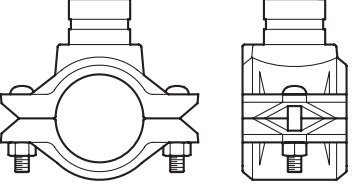
	Nominal Size	Grade “E” EPDM	List Price
	2" x 1"	7022001GRVES	\$145.50
	2½" x 1¼"	7022513GRVES	\$252.00
	2½" x 1½"	7022515GRVES	\$285.00
	3" x 1"	7023001GRVES	\$285.00
	3" x 1½"	7023015GRVES	\$326.50
	4" x 1½"	7024015GRVES	\$446.50
	4" x 2"	7024020GRVES	\$446.50
	6" x 1½"	7026015GRVES	\$630.50
	6" x 2"	7026020GRVES	\$630.50

* Galvanized available upon request.

 Orders for items in shaded areas **cannot** be cancelled or returned.

Technical Data Sheet: G220
#770 High Pressure Rigid Coupling
with Grade “E” EPDM or Grade “T” Nitrile Gasket

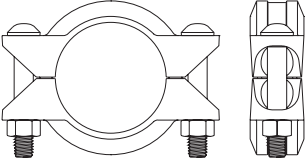
	Nominal Size	Painted			Galvanized		
		Grade “E” EPDM	Grade “T” Nitrile	List Price	Grade “E” EPDM	Grade “T” Nitrile	List Price
	2"	77020ES	77020TS	\$81.50	77020EGS	77020TGS	\$110.50
	2½"	77025ES	77025TS	\$93.50	77025EGS	77025TGS	\$125.50
	3"	77030ES	77030TS	\$104.00	77030EGS	77030TGS	\$141.00
	4"	77040ES	77040TS	\$151.00	77040EGS	77040TGS	\$215.00
	6"	77060ES	77060TS	\$271.50	77060EGS	77060TGS	\$390.50
	8"	77080ES	77080TS	\$434.00	77080EGS	77080TGS	\$623.50
	10"	77010ES	77010TS	\$801.50	77010EGS	77010TGS	\$1,096.50
	12"	77012ES	77012TS	\$1,167.00	77012EGS	77012TGS	\$1,561.50

For price and availability for the #770 High Pressure Rigid Coupling with Grade “E” EPDM Tri-Seal, Grade “T” Nitrile Tri-Seal, Grade “L” Silicone, or Grade “O” Fluoroelastomer Gasket, contact Mechanical Products.

 Orders for items in shaded areas **cannot** be cancelled or returned.

Technical Data Sheet: G138

#780 Snap Coupling
with Grade “E” EPDM Gasket or Grade “T” Nitrile Gasket

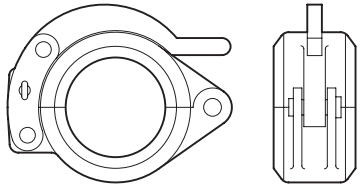
	Nominal Size	Painted			Galvanized		
		Grade “E” EPDM	Grade “T” Nitrile	List Price	Grade “E” EPDM	Grade “T” Nitrile	List Price
		1¼"	78013ES	78013TES	\$148.50	78013GES	78013GTS
1½"	78015ES	78015TES	\$143.00	78015GES	78015GTS	\$170.50	
2"	78020ES	78020TES	\$136.50	78020GES	78020GTS	\$149.00	
2½"	78025ES	78025TES	\$151.00	78025GES	78025GTS	\$179.50	
3"	78030ES	78030TES	\$174.50	78030GES	78030GTS	\$214.50	
4"	78040ES	78040TES	\$223.50	78040GES	78040GTS	\$287.00	
5"	78050ES	78050TES	\$453.50	78050GES	78050GTS	\$555.00	
6"	78060ES	78060TES	\$475.00	78060GES	78060GTS	\$600.50	
8"	78080ES	78080TES	\$728.00	78080GES	78080GTS	\$911.50	

Orders for items in shaded areas *cannot* be cancelled or returned.

Technical Data Sheet: G145

#71H Grooved Flange Adapter - Hinged
with Grade “E” EPDM Gasket or Grade “T” Nitrile Gasket

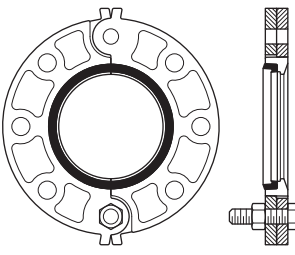
	Nominal Size	Painted			Galvanized		
		Grade “E” EPDM	Grade “T” Nitrile	List Price	Grade “E” EPDM	Grade “T” Nitrile	List Price
		2"	71H20S	71H20TS	\$316.00	71H20GS	71H20TGS
2½"	71H25S	71H25TS	\$392.50	71H25GS	71H25TGS	\$482.50	
3"	71H30S	71H30TS	\$423.50	71H30GS	71H30TGS	\$523.50	
4"	71H40S	71H40TS	\$564.50	71H40GS	71H40TGS	\$699.50	
5"	71H50S	71H50TS	\$655.50	71H50GS	71H50TGS	\$810.50	
6"	71H60S	71H60TS	\$714.50	71H60GS	71H60TGS	\$888.50	
8"	71H80S	71H80TS	\$807.50	71H80GS	71H80TGS	\$1,034.50	
10"	71H10S	71H10TS	\$1,275.00	71H10GS	71H10TGS	\$1,620.00	
12"	71H12S	71H12TS	\$1,666.50	71H12GS	71H12TGS	\$2,141.50	

Technical Data Sheet: G155

#71H Grooved Flange Adapter - Hinged
with Grade “O” Fluoroelastomer Gasket

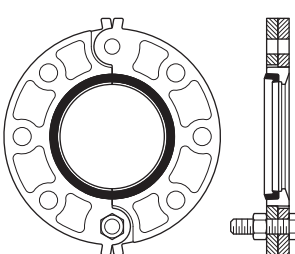
	Nominal Size	Painted		Galvanized	
		Grade “O” Fluoroelastomer	List Price	Grade “O” Fluoroelastomer	List Price
		2"	71H200S	POA	71H200GS
2½"	71H250S	POA	71H250GS	POA	
3"	71H300S	POA	71H300GS	POA	
4"	71H400S	POA	71H400GS	POA	
5"	71H500S	POA	71H500GS	POA	
6"	71H600S	POA	71H600GS	POA	
8"	71H800S	POA	71H800GS	POA	
10"	71H100S	POA	71H100GS	POA	
12"	71H120S	POA	71H120GS	POA	

Orders for items in shaded areas *cannot* be cancelled or returned.

Technical Data Sheet: G155

All standard couplings can be provided with stainless steel nuts and bolts upon request.
See latest catalog or technical data sheets for specific approvals, listings, and design parameters.
POA = Price on availability. Prices subject to change without notice.

Introduction
Couplings & Fittings
Mechanical Tees
Valves
Circuit Balancing Valves
Accessories
Copper Systems
Stainless Steel Systems
Plain End Systems
Stainless Steel G-PRESS
HDPE Systems
Gaskets & Spare Parts
Preparation Equipment
Miscellaneous
Indices

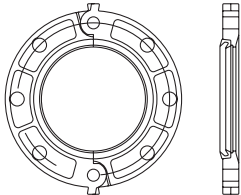
**#71 Grooved Flange Adapter
 with Grade "E" EPDM Gasket or Grade "T" Nitrile Gasket**

Nominal Size	Painted			Galvanized		
	Grade "E" EPDM	Grade "T" Nitrile	List Price	Grade "E" EPDM	Grade "T" Nitrile	List Price
2"	7120S	7120TS	\$316.00	7120GS	7120TGS	\$382.50
2½"	7125S	7125TS	\$392.50	7125GS	7125TGS	\$482.50
3"	7130S	7130TS	\$423.50	7130GS	7130TGS	\$523.50
4"	7140S	7140TS	\$564.50	7140GS	7140TGS	\$699.50
5"	7150S	7150TS	\$655.50	7150GS	7150TGS	\$810.50
6"	7160S	7160TS	\$714.50	7160GS	7160TGS	\$888.50
8"	7180S	7180TS	\$807.50	7180GS	7180TGS	\$1,034.50
10"	7110S	7110TS	\$1,275.00	7110GS	7110TGS	\$1,620.00
12"	7112S	7112TS	\$1,666.50	7112GS	7112TGS	\$2,141.50
14"	7114S	7114TS	\$3,074.00	7114GS	7114TGS	\$3,782.00
16"	7116S	7116TS	\$3,567.50	7116GS	7116TGS	\$4,422.00
18"	7118S	7118TS	\$4,391.00	7118GS	7118TGS	\$5,595.50
20"	7121S	7121TS	\$5,283.00	7121GS	7121TGS	\$6,759.50
24"	7124S	7124TS	\$6,759.50	7124GS	7124TGS	\$8,720.50

 Orders for items in shaded areas *cannot* be cancelled or returned.

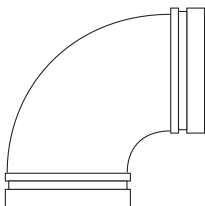
Technical Data Sheet: G150
#210 Grooved 90° Elbow

Nominal Size	Painted	List Price	Galvanized	List Price
1¼"	21013S	\$96.00	21013GS	\$127.00
1½"	21015S	\$96.00	21015GS	\$127.00
2"	21020S	\$96.00	21020GS	\$127.00
2½"	21025S	\$96.00	21025GS	\$127.00
3"	21030S	\$169.00	21030GS	\$211.00
4"	21040S	\$183.50	21040GS	\$257.00
5"	21050S	\$436.50	21050GS	\$564.00
6"	21060S	\$513.00	21060GS	\$678.50
8"	21080S	\$1,066.00	21080GS	\$1,404.00
10"	21010S	\$1,972.50	21010GS	\$2,466.00
12"	21012S	\$2,994.00	21012GS	\$3,863.50

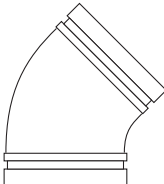
Technical Data Sheet: G180
#201 Grooved 45° Elbow

Nominal Size	Painted	List Price	Galvanized	List Price
1¼"	20113S	\$96.00	20113GS	\$121.00
1½"	20115S	\$96.00	20115GS	\$121.00
2"	20120S	\$96.00	20120GS	\$121.00
2½"	20125S	\$96.00	20125GS	\$121.00
3"	20130S	\$169.00	20130GS	\$199.00
4"	20140S	\$183.50	20140GS	\$238.00
5"	20150S	\$436.50	20150GS	\$541.00
6"	20160S	\$513.00	20160GS	\$647.50
8"	20180S	\$1,066.00	20180GS	\$1,337.00
10"	20110S	\$1,871.00	20110GS	\$2,040.50
12"	20112S	\$2,994.00	20112GS	\$3,489.50

 Orders for items in shaded areas *cannot* be cancelled or returned.

Technical Data Sheet: G180

Mechanical Products Section 2 – Couplings & Fittings



#212 and #312 – Grooved 22¹/₂° Elbow

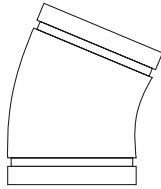

Nominal Size	Painted	List Price	Galvanized	List Price
1 ¹ / ₄ " *	21213S	\$105.00	21213GS	\$132.50
1 ¹ / ₂ " *	21215S	\$105.00	21215GS	\$132.50
2" *	21220S	\$105.00	21220GS	\$132.50
2 ¹ / ₂ " *	21225S	\$105.00	21225GS	\$132.50
3" *	21230S	\$151.00	21230GS	\$188.50
4" *	21240S	\$198.50	21240GS	\$257.00
5" *	21250S	\$604.50	21250GS	\$729.00
6" *	21260S	\$553.50	21260GS	\$704.50
8" *	21280S	\$1,151.50	21280GS	\$1,430.50
10"	31210S	\$1,519.00	31210GS	\$1,973.00
12"	31212S	\$2,053.00	31212GS	\$2,545.50
14"	31214S	\$1,350.00	31214GS	\$1,787.50
16"	31216S	\$1,619.00	31216GS	\$2,267.00
18"	31218S	\$1,960.00	31218GS	\$2,781.50
20"	31221S	\$2,461.00	31221GS	\$3,867.00
24"	31224S	\$4,199.00	31224GS	\$4,856.00

Elbow is segmentally welded except where a * indicates it is available as a cast fitting.

Orders for items in shaded areas **cannot** be cancelled or returned.

Technical Data Sheet: G180

#211 and #311 – Grooved 11¹/₄° Elbow

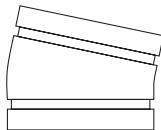

Nominal Size	Painted	List Price	Galvanized	List Price
1 ¹ / ₄ " *	21113S	\$105.00	21113GS	\$132.50
1 ¹ / ₂ " *	21115S	\$105.00	21115GS	\$132.50
2" *	21120S	\$105.00	21120GS	\$132.50
2 ¹ / ₂ " *	21125S	\$105.00	21125GS	\$132.50
3" *	21130S	\$151.00	21130GS	\$187.00
4" *	21140S	\$183.50	21140GS	\$243.00
5" *	21150S	\$604.50	21150GS	\$711.00
6" *	21160S	\$553.50	21160GS	\$668.50
8" *	21180S	\$984.50	21180GS	\$1,169.50
10"	75309	\$1,418.50	75315	\$1,693.00
12"	75310	\$2,053.00	75323	\$2,486.00
14"	75311	\$1,221.50	75324	\$1,532.50
16"	75312	\$1,504.00	75325	\$2,004.50
18"	31118S	\$1,821.00	75326	\$2,468.00
20"	31121S	\$2,228.50	75327	\$3,087.50
24"	31124S	\$3,888.50	75328	\$3,923.00

Elbow is segmentally welded except where a * indicates it is available as a cast fitting.

Orders for items in shaded areas **cannot** be cancelled or returned.

Technical Data Sheet: G180

Introduction
Couplings & Fittings
Mechanical Tees
Valves
Circuit Balancing Valves
Accessories
Copper Systems
Stainless Steel Systems
Plain End Systems
Stainless Steel G-PRESS
HDPE Systems
Gaskets & Spare Parts
Preparation Equipment
Miscellaneous
Indices

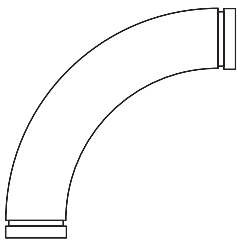
#210LR and #310LR – Grooved 90° Long Radius Elbow

<i>Nominal Size</i>	<i>Painted</i>	<i>List Price</i>	<i>Galvanized</i>	<i>List Price</i>
1 1/4"	73500	POA	310LR13GS	POA
1 1/2"	73501	POA	310LR15GS	POA
2"	75780	\$217.00	310L20GS	\$284.00
2 1/2"	75781	\$271.00	310L25GS	\$311.50
3"	75782	\$217.00	73506	\$284.00
4"	75783	\$322.00	73507	\$430.00
5"	75825	\$1,624.50	73508	\$1,861.50
6"	75784	\$933.00	73509	\$1,225.00
8"	75785	\$2,228.50	73510	\$2,848.50
10"	75786	\$2,563.00	310L10GS	\$3,204.00
12"	75787	\$2,820.00	73512	\$3,524.50
14" *	210L14S	\$3,041.50	210L14GS	\$3,946.00
16" *	210L16S	\$3,948.50	210L16GS	\$5,107.00
18"	75790	\$5,012.00	310LR18GS	\$6,246.50
20"	75826	\$6,605.50	310LR21GS	\$8,196.50
24"	75827	\$9,565.50	73517	\$11,908.00

Elbow is segmentally welded except where a * indicates it is available as a cast fitting.

 Orders for items in shaded areas **cannot** be cancelled or returned.

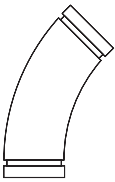
Technical Data Sheet: G180
#201LR and #301LR – Grooved 45° Long Radius Elbow

<i>Nominal Size</i>	<i>Painted</i>	<i>List Price</i>	<i>Galvanized</i>	<i>List Price</i>
1 1/4"	301L13S	POA	301L13GS	POA
1 1/2"	301L15S	POA	301L15GS	POA
2"	75791	\$188.50	301L20GS	\$238.00
2 1/2"	75792	\$600.00	301L25GS	\$674.50
3"	75793	\$188.50	73525	\$238.00
4"	75794	\$228.50	73526	\$303.50
5"	75795	\$1,514.00	301L50GS	\$1,661.50
6"	75796	\$669.50	73528	\$858.00
8"	75797	\$1,163.50	301L80GS	\$1,512.00
10"	75798	\$1,570.50	301L10GS	\$1,963.50
12"	75799	\$2,121.00	301L12GS	\$2,651.50
14" *	201L14S	\$2,277.50	201L14GS	\$2,915.00
16" *	201L16S	\$2,563.00	201L16GS	\$3,181.50
18"	75829	\$3,004.50	301L18GS	\$3,682.50
20"	75830	\$3,946.00	301L21GS	\$4,850.50
24"	75832	\$5,993.50	301L24GS	\$7,384.00

Elbow is segmentally welded except where a * indicates it is available as a cast fitting.

 Orders for items in shaded areas **cannot** be cancelled or returned.

Technical Data Sheet: G180

Mechanical Products Section 2 – Couplings & Fittings



#310 - 3D, #310 - 5D, #310 - 6D Long Radius 90° Elbow, Painted

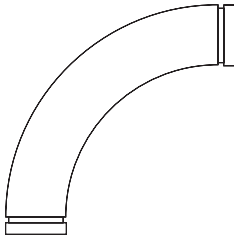

Nominal Size	3D	List Price	5D	List Price	6D	List Price
2"	310203D	\$1,560.00	310205D	\$1,674.00	310206D	\$1,717.00
2½"	310253D	\$1,666.00	310255D	\$1,724.00	310256D	\$1,795.00
3"	310303D	\$1,901.00	310305D	\$2,029.00	310306D	\$2,064.50
4"	310403D	\$2,122.00	310405D	\$2,286.00	310406D	\$2,400.00
5"	310503D	\$2,384.50	310505D	\$2,691.50	310506D	\$2,748.50
6"	310603D	\$2,797.50	310605D	\$3,096.50	310606D	\$3,339.00
8"	310803D	\$3,673.50	310805D	\$4,285.50	310806D	\$4,654.50
10"	310103D	\$4,661.00	310105D	\$5,914.50	310106D	\$6,426.50
12"	310123D	\$5,921.00	310125D	\$7,499.50	310126D	\$8,453.00
14"	310143D	\$7,197.50	310145D	\$9,404.00	310146D	\$10,524.50
16"	310163D	\$8,726.50	310165D	\$11,312.50	310166D	\$13,030.00
18"	310183D	\$12,062.50	310185D	\$15,645.00	310186D	\$17,253.50
20"	310213D	\$14,545.00	310215D	\$18,564.50	310216D	\$20,392.00
24"	310243D	\$20,341.00	310245D	\$26,232.00	310246D	\$29,341.50

Elbow is segmentally welded.

Orders for items in shaded areas **cannot** be cancelled or returned.

Technical Data Sheet: G180

#306 - 3D, #306 - 5D, #306 - 6D, Long Radius 60° Elbow, Painted

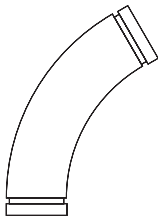

Nominal Size	3D	List Price	5D	List Price	6D	List Price
2"	306203D	\$1,509.00	306205D	\$1,583.00	306206D	\$1,611.50
2½"	306253D	\$1,580.00	306255D	\$1,660.50	306256D	\$1,682.00
3"	306303D	\$1,803.50	306305D	\$1,903.00	306306D	\$1,924.00
4"	306403D	\$2,064.50	306405D	\$2,122.00	306406D	\$2,222.00
5"	306503D	\$2,307.00	306505D	\$2,476.50	306506D	\$2,520.50
6"	306603D	\$2,578.00	306605D	\$2,797.50	306606D	\$2,831.50
8"	306803D	\$3,239.00	306805D	\$3,573.50	306806D	\$3,874.50
10"	306103D	\$4,093.50	306105D	\$4,676.00	306106D	\$5,093.50
12"	306123D	\$4,896.50	306125D	\$6,256.50	306126D	\$6,767.00
14"	306143D	\$5,981.00	306145D	\$7,568.50	306146D	\$8,177.00
16"	306163D	\$7,277.00	306165D	\$9,133.50	306166D	\$9,847.00
18"	306183D	\$10,196.50	306185D	\$12,433.00	306186D	\$13,773.50
20"	306213D	\$11,871.50	306215D	\$14,377.50	306216D	\$15,888.00
24"	306243D	\$16,627.00	306245D	\$20,560.50	306246D	\$22,565.50

Elbow is segmentally welded.

Orders for items in shaded areas **cannot** be cancelled or returned.

Technical Data Sheet: G180

Introduction
Couplings & Fittings
Mechanical Tees
Valves
Circuit Balancing Valves
Accessories
Copper Systems
Stainless Steel Systems
Plain End Systems
Stainless Steel G-PRESS
HDPE Systems
Gaskets & Spare Parts
Preparation Equipment
Miscellaneous
Indices

#301 - 3D, #301 - 5D, #301 - 6D, Long Radius 45° Elbow, Painted

	<i>Nominal Size</i>	<i>3D</i>	<i>List Price</i>	<i>5D</i>	<i>List Price</i>	<i>6D</i>	<i>List Price</i>
	2"	301203D	\$1,481.50	301205D	\$1,524.50	301206D	\$1,545.00
	2½"	301253D	\$1,567.00	301255D	\$1,596.00	301256D	\$1,653.00
	3"	301303D	\$1,788.00	301305D	\$1,872.50	301306D	\$1,895.00
	4"	301403D	\$1,965.50	301405D	\$2,080.50	301406D	\$2,100.50
	5"	301503D	\$2,180.00	301505D	\$2,328.50	301506D	\$2,357.00
	6"	301603D	\$2,535.00	301605D	\$2,599.00	301606D	\$2,761.50
	8"	301803D	\$3,153.50	301805D	\$3,417.00	301806D	\$3,496.00
	10"	301103D	\$3,701.00	301105D	\$4,206.50	301106D	\$4,583.00
	12"	301123D	\$4,697.00	301125D	\$5,323.50	301126D	\$5,799.50
	14"	301143D	\$5,376.50	301145D	\$6,483.50	301146D	\$7,044.00
	16"	301163D	\$6,556.00	301165D	\$7,853.50	301166D	\$8,508.00
	18"	301183D	\$9,272.50	301185D	\$10,831.00	301186D	\$11,639.50
	20"	301213D	\$10,787.00	301215D	\$12,542.00	301216D	\$13,962.00
	24"	301243D	\$14,428.50	301245D	\$17,377.50	301246D	\$19,278.00

Elbow is segmentally welded.

Orders for items in shaded areas **cannot** be cancelled or returned.

Technical Data Sheet: G180

#303 - 3D, #303 - 5D, #303 - 6D, Long Radius 30° Elbow, Painted

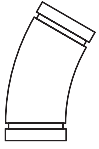
	<i>Nominal Size</i>	<i>3D</i>	<i>List Price</i>	<i>5D</i>	<i>List Price</i>	<i>6D</i>	<i>List Price</i>
	2"	303203D	\$1,448.50	303205D	\$1,476.50	303206D	\$1,490.50
	2½"	303253D	\$1,540.00	303255D	\$1,562.00	303256D	\$1,569.50
	3"	303303D	\$1,760.00	303305D	\$1,782.50	303306D	\$1,795.50
	4"	303403D	\$1,938.00	303405D	\$2,037.50	303406D	\$2,044.50
	5"	303503D	\$2,136.50	303505D	\$2,272.00	303506D	\$2,285.00
	6"	303603D	\$2,364.50	303605D	\$2,535.00	303606D	\$2,547.00
	8"	303803D	\$2,876.50	303805D	\$3,089.00	303806D	\$3,119.50
	10"	303103D	\$3,295.50	303105D	\$3,704.50	303106D	\$4,043.50
	12"	303123D	\$4,179.00	303125D	\$4,704.50	303126D	\$4,796.50
	14"	303143D	\$4,771.50	303145D	\$5,741.00	303146D	\$5,861.00
	16"	303163D	\$5,828.50	303165D	\$6,556.00	303166D	\$7,109.50
	18"	303183D	\$8,332.50	303185D	\$9,236.00	303186D	\$9,882.50
	20"	303213D	\$9,199.50	303215D	\$10,699.50	303216D	\$11,451.00
	24"	303243D	\$12,243.00	303245D	\$14,886.50	303246D	\$15,872.50

Elbow is segmentally welded.

Orders for items in shaded areas **cannot** be cancelled or returned.

Technical Data Sheet: G180

Mechanical Products Section 2 – Couplings & Fittings

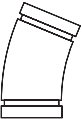

#312 3D, #312 - 5D, #312 - 6D, Long Radius 22¹/₂° Elbow, Painted

	Nominal Size	3D	List Price	5D	List Price	6D	List Price
	2"	312203D	\$1,440.50	312205D	\$1,468.00	312206D	\$1,476.00
	2 ¹ / ₂ "	312253D	\$1,540.00	312255D	\$1,553.00	312256D	\$1,560.50
	3"	312303D	\$1,752.50	312305D	\$1,773.50	312306D	\$1,780.50
	4"	312403D	\$1,922.00	312405D	\$1,944.50	312406D	\$1,958.50
	5"	312503D	\$2,122.00	312505D	\$2,150.50	312506D	\$2,164.00
	6"	312603D	\$2,342.50	312605D	\$2,371.00	312606D	\$2,520.50
	8"	312803D	\$2,833.50	312805D	\$2,847.50	312806D	\$3,069.00
	10"	312103D	\$3,253.50	312105D	\$3,601.00	312106D	\$3,658.50
	12"	312123D	\$4,078.50	312125D	\$4,234.50	312126D	\$4,633.00
	14"	312143D	POA	312145D	\$5,201.00	312146D	POA
	16"	312163D	\$5,674.50	312165D	\$6,323.50	312166D	\$6,446.00
	18"	312183D	\$7,642.00	312185D	\$8,429.00	312186D	\$9,061.00
	20"	312213D	\$8,901.00	312215D	\$9,782.00	312216D	\$10,496.00
24"	312243D	\$11,821.50	312245D	\$12,957.00	312246D	\$13,903.00	

Elbow is segmentally welded.

Orders for items in shaded areas **cannot** be cancelled or returned.

Technical Data Sheet: G180

#311 - 3D, #311 - 5D, #311 - 6D, Long Radius 11¹/₄° Elbow, Painted

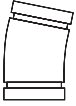
	Nominal Size	3D	List Price	5D	List Price	6D	List Price
	2"	311203D	\$1,424.50	311205D	\$1,432.50	311206D	\$1,440.50
	2 ¹ / ₂ "	311253D	\$1,524.50	311255D	\$1,531.50	311256D	\$1,531.50
	3"	311303D	\$1,738.50	311305D	\$1,744.50	311306D	\$1,752.50
	4"	311403D	\$1,902.00	311405D	\$1,909.00	311406D	\$1,915.50
	5"	311503D	\$2,093.00	311505D	\$2,108.50	311506D	\$2,114.50
	6"	311603D	\$2,307.50	311605D	\$2,320.50	311606D	\$2,336.00
	8"	311803D	\$2,578.00	311805D	\$2,777.00	311806D	\$2,791.00
	10"	311103D	\$2,933.50	311105D	\$3,218.50	311106D	\$3,232.00
	12"	311123D	\$3,617.00	311125D	\$3,694.50	311126D	\$4,049.50
	14"	311143D	\$4,102.50	311145D	\$4,553.50	311146D	\$4,604.50
	16"	311163D	\$5,027.00	311165D	\$5,151.00	311166D	\$5,616.50
	18"	311183D	\$6,833.00	311185D	\$7,451.50	311186D	\$7,539.50
	20"	311213D	\$7,968.50	311215D	\$8,151.00	311216D	\$8,756.50
24"	311243D	\$10,517.50	311245D	\$10,736.00	311246D	\$11,559.00	

Elbow is segmentally welded.

Orders for items in shaded areas **cannot** be cancelled or returned.

Technical Data Sheet: G180

Introduction
Couplings & Fittings
Mechanical Tees
Valves
Circuit Balancing Valves
Accessories
Copper Systems
Stainless Steel Systems
Plain End Systems
Stainless Steel G-PRESS
HDPE Systems
Gaskets & Spare Parts
Preparation Equipment
Miscellaneous
Indices

#316 Reducing Base Support Elbow, Groove x Flange

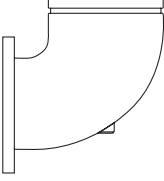
	<i>Nominal Size</i>	<i>Painted</i>	<i>List Price</i>	<i>Galvanized</i>	<i>List Price</i>
	6" x 4"	72646	\$1,722.50	72670	POA
	6" x 5"	72647	\$1,950.50	72671	POA
	8" x 5"	72645	POA	72672	POA
	8" x 6"	72649	\$2,618.50	72673	POA
	10" x 6"	72650	POA	72674	POA
	10" x 8"	72651	\$3,775.50	72675	POA
	12" x 8"	72652	POA	3161208GS	POA
	12" x 10"	72653	POA	3161210GS	POA

Elbow is segmentally welded.

 Orders for items in shaded areas **cannot** be cancelled or returned.

Technical Data Sheet: G180
#315 Groove x Male Thread – Adapter 90° Elbow

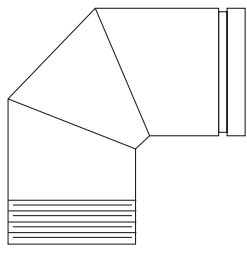
	<i>Nominal Size</i>	<i>Painted</i>	<i>List Price</i>	<i>Galvanized</i>	<i>List Price</i>
	1 1/4"	75761	\$184.50	31513GS	\$204.50
	1 1/2"	75762	\$235.00	31515GS	\$272.50
	2"	75763	\$165.00	73542	\$204.50
	2 1/2"	75764	\$286.00	73543	\$312.50
	3"	75765	\$265.00	73544	\$324.50
	4"	75766	POA	31540GS	POA
	6"	75767	\$818.00	31560GS	\$1,034.50

Elbow is segmentally welded.

 Orders for items in shaded areas **cannot** be cancelled or returned.

Technical Data Sheet: G180

Mechanical Products Section 2 – Couplings & Fittings



#219 and #319 – Grooved Tee

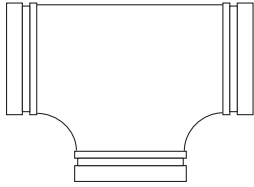

Nominal Size	Painted	List Price	Galvanized	List Price
1 ¹ / ₄ "*	21913S	\$148.50	21913GS	\$193.50
1 ¹ / ₂ "*	21915S	\$148.50	21915GS	\$193.50
2"	21920S	\$148.50	21920GS	\$193.50
2 ¹ / ₂ "*	21925S	\$148.50	21925GS	\$193.50
3"	21930S	\$203.00	21930GS	\$277.50
4"	21940S	\$308.50	21940GS	\$419.00
5"	21950S	\$718.50	21950GS	\$911.50
6"	21960S	\$829.00	21960GS	\$1,130.50
8"	21980S	\$1,815.00	21980GS	\$2,381.50
10"	21910S	\$3,639.50	21910GS	\$4,712.00
12"	21912S	\$5,073.00	21912GS	\$6,480.00
14"	21914S	\$3,053.50	21914GS	\$3,802.50
16"	21916S	\$3,448.50	21916GS	\$4,379.50
18"	73565	\$4,310.00	31918GS	\$5,557.50
20"	73566	\$6,176.00	31921GS	\$7,829.50
24"	73567	\$9,415.00	73572	\$12,211.50

Tee is segmentally welded except where a * indicates it is available as a cast fitting.

Orders for items in shaded areas **cannot** be cancelled or returned.

Technical Data Sheet: G180

#320 Groove x Male Thread – Tee

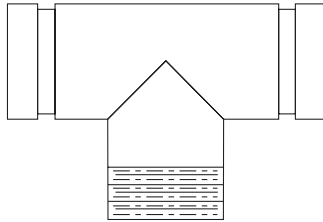

Nominal Size	Painted	List Price	Galvanized	List Price
1 ¹ / ₄ "	32013S	\$310.50	32013GS	\$364.00
1 ¹ / ₂ "	75490	\$482.50	32015GS	\$568.50
2"	75491	\$310.50	32020GS	\$364.00
2 ¹ / ₂ "	75492	POA	32025GS	POA
3"	75493	POA	32030GS	POA
4"	75465	\$640.00	32040GS	\$879.50
5"	32050S	\$1,836.50	32050GS	POA
6"	75466	\$1,640.00	32060GS	\$1,930.00
8"	32080S	POA	32080GS	POA
10"	32010S	POA	32010GS	POA
12"	32012S	POA	32012GS	POA

Tee is segmentally welded.

Orders for items in shaded areas **cannot** be cancelled or returned.

Technical Data Sheet: G180

Introduction
Couplings & Fittings
Mechanical Tees
Valves
Circuit Balancing Valves
Accessories
Copper Systems
Stainless Steel Systems
Plain End Systems
Stainless Steel G-PRESS
HDPE Systems
Gaskets & Spare Parts
Preparation Equipment
Miscellaneous
Indices

#221 and #321 – Grooved Reducing Tee

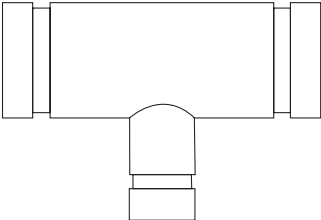
	<i>Nominal Size</i>	<i>Painted</i>	<i>List Price</i>	<i>Galvanized</i>	<i>List Price</i>
	1½" x 1½" x 1¼"	73580	\$275.50	73589	\$304.50
	2" x 2" x 1"	75410	\$312.50	75470	\$365.50
	* 2" x 2" x 1½"	2212015S	\$312.50	2212015GS	\$371.00
	2½" x 2½" x 1"	75412	\$312.50	3212510GS	\$365.50
	2½" x 2½" x 1¼"	75413	\$470.50	73590	\$553.50
	2½" x 2½" x 1½"	75414	\$312.50	73591	\$371.00
	* 2½" x 2½" x 2"	2212520S	\$312.50	2212520GS	\$371.00
	* 3" x 3" x 1"	2213010S	\$276.00	2213010GS	\$351.50
	* 3" x 3" x 1½"	2213015S	\$276.00	2213015GS	\$355.50
	* 3" x 3" x 2"	2213020S	\$276.00	2213020GS	\$355.50
	* 3" x 3" x 2½"	2213025S	\$276.00	2213025GS	\$355.50
	4" x 4" x 1"	75420	\$371.00	3214010GS	\$463.50
	4" x 4" x 1¼"	73575	\$729.00	73593	\$849.00
	4" x 4" x 1½"	75421	\$371.00	73594	\$463.50
	* 4" x 4" x 2"	2214020S	\$371.00	2214020GS	\$486.50
	* 4" x 4" x 2½"	2214025S	\$371.00	2214025GS	\$486.50
	* 4" x 4" x 3"	2214030S	\$371.00	2214030GS	\$486.50
	5" x 5" x 2"	75425	\$898.00	73595	\$1,109.50
	* 5" x 5" x 2½"	2215025S	\$732.00	2215025GS	\$921.50
	* 5" x 5" x 3"	2215030S	\$732.00	2215030GS	\$921.50
	* 5" x 5" x 4"	2215040S	\$792.00	2215040GS	\$1,000.50
	* 6" x 6" x 2"	2216020S	\$872.00	2216020GS	\$1,145.00
	* 6" x 6" x 2½"	2216025S	\$872.00	2216025GS	\$1,145.00
	* 6" x 6" x 3"	2216030S	\$872.00	2216030GS	\$1,145.00
	* 6" x 6" x 4"	2216040S	\$872.00	2216040GS	\$1,145.00
	6" x 6" x 5"	75433	\$872.00	3216050GS	\$1,151.50
	8" x 8" x 2"	73576	\$1,256.50	73599	\$1,586.00
	8" x 8" x 2½"	73574	\$1,256.50	3218025GS	\$1,586.00
	8" x 8" x 3"	75435	\$1,353.50	75482	\$1,616.50
	* 8" x 8" x 4"	2218040S	\$1,815.00	2218040GS	\$2,345.50
8" x 8" x 5"	75437	\$1,815.00	75484	\$2,361.00	
* 8" x 8" x 6"	2218060S	\$1,815.00	2218060GS	\$2,371.00	
10" x 10" x 2"	75461	\$1,848.00	73620	\$2,382.50	
10" x 10" x 3"	75439	\$1,906.00	73621	\$2,402.50	
10" x 10" x 4"	75440	\$1,935.50	73622	\$2,419.00	
10" x 10" x 5"	75441	\$1,964.50	3211005GS	\$2,455.50	
10" x 10" x 6"	75442	\$1,993.50	73624	\$2,492.50	
10" x 10" x 8"	75443	\$2,022.50	73625	\$2,528.50	
12" x 12" x 3"	73600	\$2,087.50	3211230GS	\$2,560.00	
12" x 12" x 4"	73577	\$2,108.50	73627	\$2,568.00	
12" x 12" x 5"	73578	\$2,129.50	3211205GS	\$4,168.50	
12" x 12" x 6"	75444	\$2,150.00	73629	\$2,583.50	
12" x 12" x 8"	75445	\$2,399.50	73630	\$2,882.50	
12" x 12" x 10"	75446	\$2,534.00	73631	\$3,062.00	
14" x 14" x 6"	75447	\$2,761.50	3211460GS	\$3,314.00	
14" x 14" x 8"	73579	\$2,829.00	73633	\$3,394.50	
14" x 14" x 10"	75448	\$2,992.00	3211410GS	\$3,590.50	
14" x 14" x 12"	75449	\$3,202.00	75486	\$3,842.00	

See latest catalog or technical data sheets for specific approvals, listings, and design parameters.
 POA = Price on availability. Prices subject to change without notice.

Customer Service: (800) 558-5236

Mechanical Products Section 2 – Couplings & Fittings



#221 and #321 – Grooved Reducing Tee

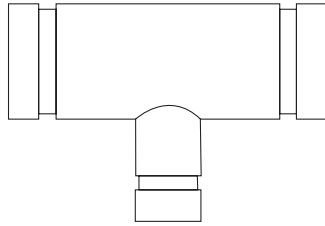

(Continued from Previous page)

<i>Nominal Size</i>	<i>Painted</i>	<i>List Price</i>	<i>Galvanized</i>	<i>List Price</i>
16" x 16" x 4"	75454	POA	73635	POA
16" x 16" x 8"	75450	\$2,497.50	73636	\$3,165.50
16" x 16" x 10"	75451	\$2,698.50	3211610GS	\$3,418.50
16" x 16" x 12"	75452	\$2,752.50	75469	\$3,496.50
16" x 16" x 14"	75453	\$3,223.00	3211614GS	\$4,008.00
18" x 18" x 8"	75455	\$3,182.50	3211880GS	\$4,209.50
18" x 18" x 10"	75456	\$3,302.50	3211810GS	\$4,253.50
18" x 18" x 12"	75457	\$3,302.50	3211812GS	\$4,295.00
18" x 18" x 14"	75458	\$3,821.50	3211814GS	\$4,913.50
18" x 18" x 16"	75459	\$4,171.00	3211816GS	\$5,268.00
20" x 20" x 14"	73581	\$5,087.00	3212114GS	\$6,476.00
20" x 20" x 16"	73582	\$5,457.00	3212116GS	\$6,917.50
20" x 20" x 18"	73583	\$6,001.00	3212118GS	\$7,587.00
24" x 24" x 10"	73584	\$6,633.00	73647	\$8,336.50
24" x 24" x 12"	73585	\$6,820.00	73648	\$9,594.50
24" x 24" x 14"	3212414S	\$7,607.50	73649	\$10,429.00
24" x 24" x 16"	73587	\$7,778.00	73650	\$10,663.50
24" x 24" x 18"	75460	\$7,922.00	73651	\$10,882.50
24" x 24" x 20"	3212420S	\$8,600.50	73652	\$12,610.50

Tee is segmentally welded except where a * indicates it is available as a cast fitting.

Orders for items in shaded areas **cannot** be cancelled or returned.

Technical Data Sheet: G180

#323 Groove x Male Thread – Reducing Tee with Threaded Branch

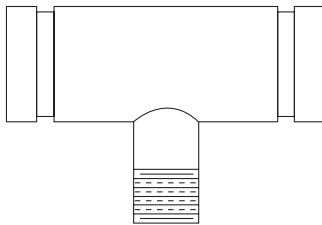

<i>Nominal Size</i>	<i>Painted</i>	<i>List Price</i>	<i>Galvanized</i>	<i>List Price</i>
1 1/2" x 1 1/2" x 1 1/4"	73653	POA	3231513GS	POA
2" x 2" x 1"	75500	\$330.00	75520	\$386.50
2" x 2" x 1 1/4"	75409	\$554.00	3232013GS	\$592.50
2" x 2" x 1 1/2"	75501	\$330.00	75522	\$392.00
2 1/2" x 2 1/2" x 1"	76502	\$330.00	75408	\$386.50
2 1/2" x 2 1/2" x 1 1/4"	75502	\$719.00	73608	\$739.00
2 1/2" x 2 1/2" x 1 1/2"	75503	\$330.00	73609	\$392.00
2 1/2" x 2 1/2" x 2"	75504	\$330.00	73610	\$395.00
3" x 3" x 1"	75505	\$330.00	75521	\$412.00
3" x 3" x 1 1/2"	75506	\$330.00	75546	\$414.50
3" x 3" x 2"	75507	\$330.00	75523	\$414.50
3" x 3" x 2 1/2"	75508	\$793.00	73611	\$858.50
4" x 4" x 1"	75509	\$412.00	75524	\$507.00
4" x 4" x 1 1/4"	76541	\$845.50	3234013GS	\$911.00
4" x 4" x 1 1/2"	75541	\$412.00	76524	\$516.00
4" x 4" x 2"	75510	\$412.00	75525	\$516.00
4" x 4" x 2 1/2"	75511	\$412.00	73691	\$531.00
4" x 4" x 3"	75512	\$412.00	75526	\$532.50
5" x 5" x 2"	75513	\$880.00	75534	\$959.00
5" x 5" x 2 1/2"	76822	\$791.00	3235025GS	\$1,001.50
5" x 5" x 3"	3235030S	\$732.00	75535	\$921.50
5" x 5" x 4"	3235040S	\$791.00	3235040GS	\$1,078.50

#323 Groove x Male Thread – Reducing Tee with Threaded Branch

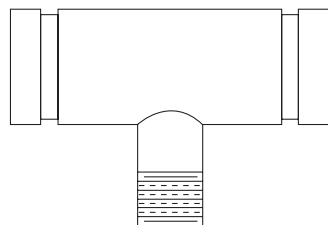

(Continued from Previous page)

<i>Nominal Size</i>	<i>Painted</i>	<i>List Price</i>	<i>Galvanized</i>	<i>List Price</i>
6" x 6" x 2"	75514	\$1,027.00	75527	\$1,278.00
6" x 6" x 2 1/2"	75590	\$1,027.00	75528	\$1,278.00
6" x 6" x 3"	75515	\$1,027.00	75529	\$1,278.00
6" x 6" x 4"	75516	\$1,297.00	73694	\$1,394.50
6" x 6" x 5"	75517	\$1,027.00	3236050GS	\$1,278.00
8" x 8" x 2"	75518	\$1,256.50	73696	\$1,732.50
8" x 8" x 3"	75519	\$1,732.50	3238030GS	\$2,246.50
8" x 8" x 4"	3238040S	\$1,815.00	3238040GS	\$2,345.50
8" x 8" x 5"	3238050S	\$1,815.00	3238050GS	\$2,352.00
8" x 8" x 6"	3238060S	\$2,008.00	3238060GS	\$2,758.00
10" x 10" x 2"	73659	\$2,104.50	3231020GS	\$3,074.00
10" x 10" x 3"	3231030S	\$2,104.50	3231030GS	\$2,610.50
10" x 10" x 4"	3231040S	\$2,201.50	3231040GS	\$2,813.50
10" x 10" x 5"	3231050S	\$1,935.50	3231050GS	\$2,872.00
10" x 10" x 6"	3231060S	\$2,250.00	3231060GS	\$2,910.00
10" x 10" x 8"	3231080S	\$3,034.00	3231080GS	\$3,391.50
12" x 12" x 3"	3231230S	\$2,834.00	3231230GS	\$3,658.50
12" x 12" x 4"	3231240S	\$3,036.50	3231240GS	\$3,899.50
12" x 12" x 5"	3231250S	\$3,210.00	3231250GS	\$4,169.00
12" x 12" x 6"	3231260S	\$3,248.50	3231260GS	\$4,208.00
12" x 12" x 8"	3231280S	\$3,340.00	3231280GS	\$4,305.50
12" x 12" x 10"	3231210S	\$3,495.50	3231210GS	\$4,312.00

Tee is segmentally welded.

Orders for items in shaded areas *cannot* be cancelled or returned.

Technical Data Sheet: G180

Mechanical Products Section 2 – Couplings & Fittings



#250 and #350 – Grooved Concentric Reducer

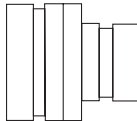

<i>Nominal Size</i>	<i>Painted</i>	<i>List Price</i>	<i>Galvanized</i>	<i>List Price</i>
1 1/4" x 1"	3501301S	\$448.50	3501301GS	\$493.50
1 1/2" x 1"	74328	\$112.50	73400	\$132.00
* 1 1/2" x 1 1/4"	2501513S	\$112.50	2501513GS	\$132.00
2" x 1"	72852	\$112.50	73402	\$132.00
2" x 1 1/4"	72853	\$122.50	73403	\$144.00
2" x 1 1/2"	72854	\$112.50	73404	\$132.00
2 1/2" x 1"	72855	\$152.50	73393	\$175.00
* 2 1/2" x 1 1/4"	2502513S	\$112.50	2502513GS	\$132.00
* 2 1/2" x 1 1/2"	2502515S	\$112.50	2502515GS	\$132.00
* 2 1/2" x 2"	2502520S	\$112.50	2502520GS	\$132.00
3" x 1"	72860	\$122.50	73406	\$149.00
3" x 1 1/4"	72861	\$195.50	73396	\$225.00
* 3" x 1 1/2"	2503015S	\$135.00	2503015GS	\$164.00
* 3" x 2"	2503020S	\$99.50	2503020GS	\$121.00
* 3" x 2 1/2"	2503025S	\$135.00	2503025GS	\$163.00
4" x 1"	72867	\$148.50	73409	\$182.00
4" x 1 1/4"	72868	\$1,129.00	3504013GS	\$1,265.50
4" x 1 1/2"	72869	\$204.50	73410	\$270.00
* 4" x 2"	2504020S	\$132.00	2504020GS	\$162.00
* 4" x 2 1/2"	2504025S	\$163.00	2504025GS	\$198.00
* 4" x 3"	2504030S	\$163.00	2504030GS	\$198.00
5" x 2"	72876	\$1,588.00	73399	\$1,754.00
5" x 2 1/2"	72877	\$330.00	3505025GS	\$402.00
* 5" x 3"	2505030S	\$188.50	2505030GS	\$233.00
* 5" x 4"	2505040S	\$224.00	2505040GS	\$280.00
* 6" x 2"	2506020S	\$296.50	2506020GS	\$369.50
* 6" x 2 1/2"	2506025S	\$330.00	2506025GS	\$405.00
* 6" x 3"	2506030S	\$296.50	2506030GS	\$369.50
* 6" x 4"	2506040S	\$260.00	2506040GS	\$335.00
* 6" x 5"	2506050S	\$382.50	2506050GS	\$474.00
8" x 2 1/2"	73749	POA	73761	POA
* 8" x 3"	2508030S	\$527.50	2508030GS	\$657.00
* 8" x 4"	2508040S	\$527.50	2508040GS	\$660.00
* 8" x 5"	2508050S	\$527.50	2508050GS	\$664.00
* 8" x 6"	2508060S	\$669.00	2508060GS	\$837.50
10" x 4"	72889	\$1,199.50	73764	\$1,477.00
10" x 5"	73750	\$2,638.50	3501050GS	\$3,010.50
* 10" x 6"	2501060S	\$1,312.50	2501060GS	\$1,635.50
* 10" x 8"	2501080S	\$1,312.50	2501080GS	\$1,663.50
* 12" x 4"	2501240S	\$5,740.50	2501240GS	\$6,832.00
* 12" x 6"	2501260S	\$1,565.00	2501260GS	\$1,933.50
* 12" x 8"	2501280S	\$2,346.50	2501280GS	\$2,770.50
* 12" x 10"	2501210S	\$2,346.50	2501210GS	\$2,904.50

Introduction
Couplings & Fittings
Mechanical Tees
Valves
Circuit Balancing Valves
Accessories
Copper Systems
Stainless Steel Systems
Plain End Systems
Stainless Steel G-PRESS
HDPE Systems
Gaskets & Spare Parts
Preparation Equipment
Miscellaneous
Indices

#250 and #350 – Grooved Concentric Reducer

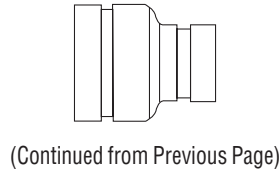

<i>Nominal Size</i>	<i>Painted</i>	<i>List Price</i>	<i>Galvanized</i>	<i>List Price</i>
14" x 6"	72897	\$5,047.00	3501460GS	\$5,470.50
14" x 8"	72898	\$2,860.50	3501480GS	\$3,165.00
14" x 10"	72899	\$2,500.50	73770	\$2,789.50
14" x 12"	72900	\$2,736.50	73771	\$3,086.00
16" x 8"	72901	\$4,097.50	3501680GS	\$4,468.00
16" x 10"	72902	\$3,937.00	3501610GS	\$4,468.00
16" x 12"	72903	\$3,990.00	73774	\$4,493.50
16" x 14"	72904	\$3,990.00	3501614GS	\$4,548.50
18" x 12"	72906	\$5,611.00	3501812GS	\$7,324.00
18" x 14"	72910	\$4,543.00	3501814GS	\$5,723.50
18" x 16"	72911	\$4,543.00	3501816GS	\$5,723.50
20" x 10"	73751	\$6,556.50	73779	POA
20" x 12"	72915	\$6,113.50	3502112GS	\$7,409.00
20" x 14"	73752	\$6,138.00	3502114GS	\$7,423.50
20" x 16"	73753	\$4,940.50	3502116GS	\$6,088.00
20" x 18"	73754	\$4,756.00	3502118GS	\$8,150.50
24" x 10"	72920	\$13,134.50	73784	POA
24" x 12"	72921	\$14,339.00	73785	POA
24" x 14"	72922	\$10,782.50	73786	\$16,025.00
24" x 16"	72923	\$11,732.50	73787	\$16,999.50
24" x 18"	72924	\$11,225.50	3502418GS	\$13,550.00
24" x 20"	72925	\$9,033.00	3502421GS	\$11,369.50

Reducer is segmentally welded except where a * indicates it is available as a cast fitting.

Orders for items in shaded areas *cannot* be cancelled or returned.

Technical Data Sheet: G180

#251 and #351 – Grooved Eccentric Reducer

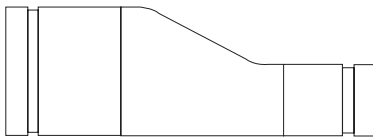

<i>Nominal Size</i>	<i>Painted</i>	<i>List Price</i>	<i>Galvanized</i>	<i>List Price</i>
1 1/2" x 1"	3511510S	\$471.50	3511510GS	\$551.50
1 1/2" x 1 1/4"	73812	\$463.00	3511513GS	\$576.50
2" x 1"	73815	\$522.00	3512010GS	\$551.00
2" x 1 1/4"	73813	\$570.00	73846	POA
2" x 1 1/2"	72930	\$117.00	3512015GS	\$138.50
2 1/2" x 1"	3512510S	\$1,228.50	3512510GS	\$1,360.00
2 1/2" x 1 1/4"	72931	\$125.00	3512513GS	\$144.50
2 1/2" x 1 1/2"	72932	\$569.00	3512515GS	\$650.00
2 1/2" x 2"	72933	\$233.00	73851	\$316.00
3" x 1"	3513010S	\$1,318.00	3513010GS	\$1,450.50
3" x 1 1/4"	73814	\$1,194.00	3513013GS	POA
3" x 1 1/2"	76587	\$657.00	3513015GS	\$767.00
* 3" x 2"	2513020S	\$266.00	2513020GS	\$363.00
* 3" x 2 1/2"	2513025S	\$266.00	2513025GS	\$371.00
4" x 1"	3514010S	\$2,667.00	3514010GS	POA
4" x 1 1/4"	73817	POA	3514013GS	POA
4" x 1 1/2"	73816	\$1,614.00	3514015GS	\$1,743.00
* 4" x 2"	2514020S	\$324.00	2514020GS	\$452.00
* 4" x 2 1/2"	2514025S	\$324.00	2514025GS	\$452.00
* 4" x 3"	2514030S	\$324.00	2514030GS	\$452.00

Mechanical Products Section 2 – Couplings & Fittings

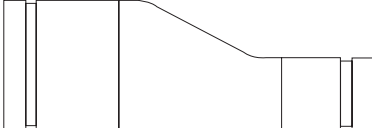

#251 and #351 – Grooved Eccentric Reducer

	<i>Nominal Size</i>	<i>Painted</i>	<i>List Price</i>	<i>Galvanized</i>	<i>List Price</i>
	5" x 2"	73818	\$1,780.00	73860	\$2,048.00
	5" x 2 1/2"	73819	\$1,516.50	73861	POA
	5" x 3"	72939	\$1,466.00	3515030GS	\$1,633.50
	* 5" x 4"	2515040S	\$439.50	2515040GS	\$620.00
	6" x 2"	73820	\$2,520.50	72963	\$2,744.50
	6" x 2 1/2"	72941	\$3,000.00	3516025GS	\$3,265.50
	* 6" x 3"	2516030S	\$583.00	2516030GS	\$818.00
	* 6" x 4"	2516040S	\$511.50	2516040GS	\$750.50
	* 6" x 5"	2516050S	\$613.00	2516050GS	\$868.50
	8" x 3"	72946	\$2,926.50	3518030GS	\$3,187.50
	8" x 4"	72947	\$2,559.50	3518040GS	\$2,920.00
	8" x 5"	72948	\$2,559.50	3518050GS	\$2,920.00
	8" x 6"	72949	\$1,031.00	3518060GS	\$1,403.00
	10" x 4"	72950	\$4,518.00	3511040GS	\$5,418.00
	10" x 5"	3511050S	\$4,255.50	3511050GS	\$5,008.00
	10" x 6"	72951	\$3,210.00	3511060GS	\$3,805.00
	10" x 8"	72952	\$2,718.00	73875	\$3,379.50
	12" x 4"	3511240S	\$4,730.50	3511240GS	\$5,582.00
	12" x 5"	3511250S	POA	3511250GS	POA
	12" x 6"	73823	\$4,287.50	73877	\$5,164.00
	12" x 8"	72953	\$4,179.00	73878	\$4,999.50
	12" x 10"	72954	\$3,741.50	3511210GS	\$4,436.50
	14" x 6"	3511460S	\$6,163.00	3511460GS	\$7,335.00
	14" x 8"	72955	\$4,667.00	3511480GS	\$5,325.00
	14" x 10"	73825	\$4,269.00	3511410GS	\$4,668.50
	14" x 12"	72956	\$4,146.00	73883	\$4,535.00
	16" x 8"	3511680S	\$6,807.00	73884	\$7,488.00
	16" x 10"	3511610S	\$6,293.00	73885	\$7,232.50
	16" x 12"	72958	\$6,186.00	3511612GS	\$6,765.50
	16" x 14"	73830	\$6,054.50	73887	\$7,321.50
18" x 12"	73831	\$8,033.00	73888	\$9,237.50	
18" x 14"	73832	\$7,299.00	3511814GS	\$8,827.00	
18" x 16"	73833	\$7,299.00	3511816GS	\$9,210.00	
20" x 12"	3512112S	\$8,338.00	73892	POA	
20" x 14"	73836	\$8,567.50	73893	POA	
20" x 16"	73837	\$8,273.50	3512116GS	\$10,006.00	
20" x 18"	73838	\$8,273.50	3512118GS	\$10,441.00	
24" x 10"	3512410S	POA	3512410GS	POA	
24" x 12"	73840	\$11,079.50	73897	POA	
24" x 14"	73841	\$13,906.00	73898	POA	
24" x 16"	73842	\$13,906.00	73899	\$15,991.50	
24" x 18"	73843	\$13,116.00	3512418GS	\$15,463.50	
24" x 20"	3512421S	\$13,272.50	3512421GS	\$16,391.50	

(Continued from Previous Page)

Reducer is segmentally welded except where a * indicates it is available as a cast fitting.

Orders for items in shaded areas **cannot** be cancelled or returned.

Technical Data Sheet: G180

Introduction
Couplings & Fittings
Mechanical Tees
Valves
Circuit Balancing Valves
Accessories
Copper Systems
Stainless Steel Systems
Plain End Systems
Stainless Steel G-PRESS
HDPE Systems
Gaskets & Spare Parts
Preparation Equipment
Miscellaneous
Indices

#372 Groove x Male Thread – Reducer

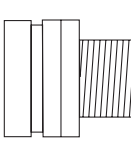
	Nominal Size	Painted	List Price	Galvanized	List Price
	1 1/2" x 1"	76800	\$117.00	76825	\$143.50
	2" x 3/4"	76801	\$117.00	76826	\$143.50
	2" x 1"	76802	\$117.00	76827	\$143.50
	2" x 1 1/4"	76815	\$117.00	3722013GS	\$143.50
	2" x 1 1/2"	76803	\$117.00	76828	\$143.50
	2 1/2" x 1 1/4"	76816	\$165.00	3722513GS	\$203.00
	2 1/2" x 1 1/2"	76817	\$173.00	3722515GS	\$203.00
	2 1/2" x 2"	76804	\$117.00	76829	\$143.50
	3" x 1"	76805	\$127.00	76830	\$153.00
	3" x 1 1/4"	76818	\$398.50	3723013GS	\$443.00
	3" x 1 1/2"	76819	\$143.50	73797	\$171.50
	3" x 2"	76806	\$143.50	76831	\$171.50
	3" x 2 1/2"	76807	\$173.00	76832	\$203.00
	4" x 1"	76808	\$163.50	76833	\$198.00
	4" x 1 1/4"	76820	POA	3724013GS	POA
	4" x 1 1/2"	76821	\$381.00	73799	\$498.00
	4" x 2"	76809	\$174.00	76834	\$208.00
	4" x 2 1/2"	76810	\$174.50	76835	\$214.00
	4" x 3"	76811	\$213.50	76836	\$252.00
	5" x 3"	3725030S	POA	3725030GS	POA
5" x 4"	3725040S	\$1,204.50	3725040GS	\$1,310.00	
6" x 1"	76812	\$330.00	76837	\$405.00	
6" x 2"	76813	\$330.00	76838	\$405.00	
6" x 3"	76814	\$330.00	76839	\$405.00	
6" x 4"	73792	\$1,977.00	3726040GS	\$2,189.50	
6" x 5"	73793	POA	73802	POA	

Reducer is segmentally welded.

Orders for items in shaded areas **cannot** be cancelled or returned.

Technical Data Sheet: G180

#391 Groove x Male Thread – Adapter Nipple

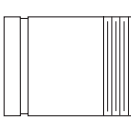
	Nominal Size (O.D. x Length)	Painted	List Price	Galvanized	List Price
	1 1/4" x 4" L	75121	\$58.00	74292	POA
	1 1/2" x 4" L	75122	\$58.50	74293	POA
	2" x 4" L	75123	\$58.50	74294	POA
	2 1/2" x 4" L	75124	\$67.00	74295	POA
	3" x 4" L	75125	\$82.00	74296	POA
	3" x 6" L	74335	\$131.00	3913060GS	POA
	4" x 6" L	75126	\$132.00	74297	POA
	5" x 6" L	75129	\$272.00	3915060GS	POA
	6" x 6" L	75130	\$350.50	3916060GS	POA
	8" x 6" L	75131	\$391.50	74336	POA
	10" x 8" L	75132	\$548.00	74337	POA
	12" x 8" L	75133	\$686.00	74338	POA

Adapter Nipple is segmentally welded.

Orders for items in shaded areas **cannot** be cancelled or returned.

Technical Data Sheet: G180

Mechanical Products Section 2 – Couplings & Fittings



#392 Groove x Groove – Adapter Nipple

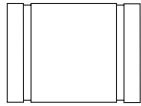

Nominal Size (O.D. x Length)	Painted	List Price	Galvanized	List Price
1 1/4" x 4" L	75098	\$58.00	74339	POA
1 1/2" x 4" L	75099	\$58.50	3921540GS	POA
2" x 4" L	75100	\$58.00	3922040GS	POA
2 1/2" x 4" L	75101	\$67.00	3922540GS	POA
3" x 4" L	75102	\$81.00	3923040GS	POA
4" x 6" L	75103	\$133.50	74309	POA
5" x 6" L	75104	\$272.00	3925060GS	POA
6" x 6" L	75105	\$350.50	74311	POA
8" x 6" L	75106	\$391.50	3928060GS	POA
10" x 8" L	75107	\$548.00	3921080GS	POA
12" x 8" L	75108	\$686.00	3921280GS	POA

Adapter Nipple is segmentally welded.

Orders for items in shaded areas **cannot** be cancelled or returned.

Technical Data Sheet: G180

#393 Groove x Beveled – Adapter Nipple

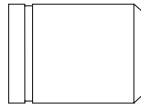

Nominal Size (O.D. x Length)	Painted	List Price	Galvanized	List Price
1 1/4" x 4" L	75148	\$58.00	3931340GS	POA
1 1/2" x 4" L	3931540S	\$58.50	3931540GS	POA
2" x 4" L	75150	\$58.00	3932040GS	POA
2 1/2" x 4" L	75151	\$67.00	3932540GS	POA
3" x 4" L	75152	\$81.00	74330	POA
4" x 6" L	75153	\$132.00	74331	POA
5" x 6" L	75158	\$272.00	3935060GS	POA
6" x 6" L	75154	\$350.50	3936060GS	POA
8" x 6" L	75155	\$391.50	3938060GS	POA
10" x 8" L	75156	\$548.00	3931080GS	POA
12" x 8" L	75157	\$686.00	3931280GS	POA

Adapter Nipple is segmentally welded.

Orders for items in shaded areas **cannot** be cancelled or returned.

Technical Data Sheet: G180

#395 Hose Adapter Nipple, Groove x Hose

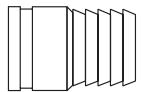

Nominal Size (O.D. x Length)	Painted	List Price	Galvanized	List Price
1" x 3 1/4" L	72680	\$190.00	72692	POA
1 1/4" x 3 5/8" L	72681	\$190.00	72693	POA
1 1/2" x 4" L	72682	\$190.00	72694	\$226.50
2" x 4 5/8" L	72683	\$190.00	72695	\$226.50
2 1/2" x 5 1/2" L	72684	\$190.00	72696	\$226.50
3" x 6" L	72685	\$273.50	72697	\$329.50
4" x 7 1/4" L	72686	\$473.50	72698	\$569.50
5" x 9 3/4" L	72687	\$714.50	72699	POA
6" x 11" L	72688	\$848.00	72620	POA
8" x 12 1/2" L	39580125S	\$1,755.50	39580125GS	POA
10" x 14" L	3951014S	\$1,730.00	72622	POA
12" x 16" L	72691	POA	72623	POA

Adapter Nipple is segmentally welded.

Orders for items in shaded areas **cannot** be cancelled or returned.

Technical Data Sheet: G180

Introduction
Couplings & Fittings
Mechanical Tees
Valves
Circuit Balancing Valves
Accessories
Copper Systems
Stainless Steel Systems
Plain End Systems
Stainless Steel G-PRESS
HDPE Systems
Gaskets & Spare Parts
Preparation Equipment
Miscellaneous
Indices

#380 Female Thread Adapter, Groove x Female Pipe Thread

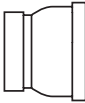
	Nominal Size	Painted	List Price	Galvanized	List Price
	1"	72601	\$527.50	72607	\$566.00
	1 1/4"	72602	\$279.00	72608	\$312.50
	1 1/2"	72603	\$361.00	72609	\$385.00
	2"	72604	\$171.50	72610	\$200.50
	2 1/2"	72613	\$171.50	72614	\$200.50
	3"	72605	\$198.50	72611	\$242.00
	4"	72606	\$303.00	72612	\$379.50

Adapter is segmentally welded.

 Orders for items in shaded areas **cannot** be cancelled or returned.

Technical Data Sheet: G180
#314 Grooved Lateral

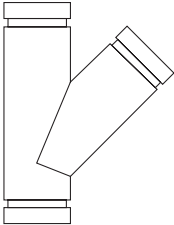
	Nominal Size	Painted	List Price	Galvanized	List Price
	1 1/4"	31413S	\$569.50	31413GS	POA
	1 1/2"	31415S	POA	31415GS	POA
	2"	75700	\$567.50	74700	\$694.50
	2 1/2"	75701	\$569.50	74701	\$697.00
	3"	75702	\$629.00	74702	\$792.00
	4"	75703	\$967.00	74703	\$1,204.50
	5"	31450S	\$1,411.50	31405GS	\$1,772.00
	6"	75704	\$2,272.00	74704	\$2,728.50
	8"	75705	\$3,269.50	74705	\$3,962.00
	10"	75706	\$4,441.50	31410GS	\$5,152.00
	12"	75707	\$5,368.50	31412GS	\$6,803.00
	14"	75708	\$4,483.50	31414GS	\$5,752.50
	16"	31416S	\$5,600.00	31416GS	\$7,193.00
	18"	75710	\$6,260.00	31418GS	\$8,137.50
	20"	75711	\$9,494.50	31421GS	\$12,031.00
	24"	75712	\$14,753.00	31424GS	\$17,190.50

Lateral is segmentally welded.

 Orders for items in shaded areas **cannot** be cancelled or returned.

Technical Data Sheet: G180

Mechanical Products Section 2 – Couplings & Fittings



#325 Grooved Reducing Lateral

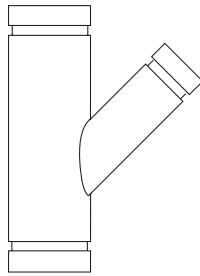

	<i>Nominal Size</i>	<i>Painted</i>	<i>List Price</i>	<i>Galvanized</i>	<i>List Price</i>
	3" x 3" x 2"	75670	\$493.00	3253020GS	\$615.00
	3" x 3" x 2 1/2"	75671	\$493.00	75695	POA
	4" x 4" x 2"	75672	\$967.00	74672	\$1,151.50
	4" x 4" x 2 1/2"	75673	\$967.00	74673	\$1,192.50
	4" x 4" x 3"	75674	\$967.00	3254030GS	\$1,203.00
	5" x 5" x 2"	75675	\$1,411.50	74675	POA
	5" x 5" x 2 1/2"	3255025S	POA	73935	POA
	5" x 5" x 3"	75676	\$1,411.50	74676	\$1,750.50
	5" x 5" x 4"	75677	\$1,411.50	74677	\$1,778.50
	6" x 6" x 2"	75678	POA	74678	POA
	6" x 6" x 2 1/2"	3256025S	POA	3256025GS	POA
	6" x 6" x 3"	75679	\$1,822.00	74679	\$2,279.00
	6" x 6" x 4"	75680	\$1,822.00	74680	\$2,295.00
	6" x 6" x 5"	75681	\$1,822.00	74681	\$2,319.50
	8" x 8" x 4"	75682	\$2,628.00	74682	\$3,335.50
	8" x 8" x 5"	75683	\$2,628.00	74683	\$3,365.00
	8" x 8" x 6"	75684	\$2,628.00	74684	\$3,406.00
	10" x 10" x 4"	75685	\$2,876.00	74685	\$3,778.00
	10" x 10" x 5"	75686	POA	74686	\$4,028.50
	10" x 10" x 6"	75687	\$3,154.50	74687	\$4,030.00
	10" x 10" x 8"	75688	\$3,213.00	74688	\$4,288.00
	12" x 12" x 4"	75689	POA	74689	POA
	12" x 12" x 6"	75690	\$3,728.50	74690	\$5,314.50
	12" x 12" x 8"	75691	\$3,776.00	74691	\$5,100.50
	12" x 12" x 10"	75692	\$3,826.00	74692	\$5,267.50
	14" x 14" x 4"	73913	\$1,980.50	73937	\$2,979.50
	14" x 14" x 6"	73914	\$2,126.00	3251460GS	\$3,179.00
	14" x 14" x 8"	73915	\$2,286.50	3251480GS	\$3,596.50
	14" x 14" x 10"	73916	\$2,898.50	3251410GS	\$3,797.50
	14" x 14" x 12"	73917	\$2,941.50	3251412GS	\$4,215.50
	16" x 16" x 6"	73918	\$3,081.50	3251660GS	\$4,385.00
	16" x 16" x 8"	73919	\$3,258.50	3251680GS	\$5,244.50
	16" x 16" x 10"	73920	\$3,803.00	3251610GS	\$5,189.50
	16" x 16" x 12"	73921	\$3,963.50	3251612GS	\$5,566.00
	16" x 16" x 14"	73922	\$3,963.50	3251614GS	\$5,566.00
	18" x 18" x 6"	73923	\$3,963.50	3251860GS	\$5,566.00
	18" x 18" x 8"	73924	\$3,963.50	3251880GS	\$5,566.00
	18" x 18" x 10"	73925	POA	73949	POA
	18" x 18" x 12"	73926	\$4,405.00	73950	\$6,227.00
	18" x 18" x 14"	73927	\$5,273.00	3251814GS	\$6,858.00
	18" x 18" x 16"	73928	\$5,931.50	3251816GS	\$7,662.00
	20" x 20" x 12"	73929	\$5,668.50	3252112GS	\$8,095.00
	20" x 20" x 14"	73930	\$5,843.50	3252114GS	\$8,342.50
	20" x 20" x 16"	73931	\$6,893.00	3252116GS	\$9,581.00
	24" x 24" x 16"	73932	\$13,084.00	74327	\$16,848.00
	24" x 24" x 20"	73933	\$14,233.00	3252421GS	\$17,405.00

Lateral is segmentally welded.

Orders for items in shaded areas **cannot** be cancelled or returned.

Technical Data Sheet: G180

Introduction
Couplings & Fittings
Mechanical Tees
Valves
Circuit Balancing Valves
Accessories
Copper Systems
Stainless Steel Systems
Plain End Systems
Stainless Steel G-PRESS
HDPE Systems
Gaskets & Spare Parts
Preparation Equipment
Miscellaneous
Indices

#324 Grooved Wye

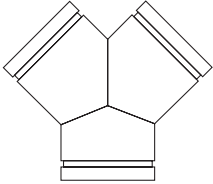
	<i>Nominal Size</i>	<i>Painted</i>	<i>List Price</i>	<i>Galvanized</i>	<i>List Price</i>
	1 1/4"	75901	\$544.00	74224	POA
	1 1/2"	75902	\$546.00	32415GS	\$647.50
	2"	75903	\$546.00	74226	\$650.00
	2 1/2"	75904	\$546.00	32425GS	\$650.00
	3"	75905	\$652.50	74228	\$776.00
	4"	75906	\$851.50	74229	\$1,024.00
	5"	75907	\$1,223.00	32450GS	\$1,468.00
	6"	75908	\$1,509.00	74231	\$1,838.50
	8"	75909	\$2,173.00	32480GS	\$2,670.50
	10"	75910	\$3,608.00	74233	\$4,419.50
	12"	75911	\$3,985.00	74234	\$5,040.50
	14"	75912	\$2,741.00	32414GS	\$3,421.00
	16"	75913	\$3,809.50	32416GS	\$4,548.50
	18"	75914	\$4,441.50	32418GS	\$5,422.50
	20"	75915	\$5,943.00	32421GS	\$7,355.00
24"	75916	\$10,597.50	32424GS	\$11,167.50	

Wye is segmentally welded.

 Orders for items in shaded areas **cannot** be cancelled or returned.

Technical Data Sheet: G180
#331 Grooved Reducing Tee Wye

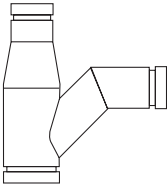
	<i>Nominal Size</i>	<i>Painted</i>	<i>List Price</i>	<i>Galvanized</i>	<i>List Price</i>
	4" x 3" x 3"	3314030S	\$1,457.50	3314030GS	\$1,733.00
	4" x 3" x 4"	75734	\$2,072.50	74214	\$2,482.50
	5" x 3" x 3"	3315030S	\$1,968.00	3315030GS	\$2,310.00
	5" x 3" x 5"	75736	POA	331503050GS	POA
	5" x 4" x 3"	74208	POA	74217	POA
	5" x 4" x 4"	75737	POA	74218	POA
	6" x 4" x 6"	74209	\$7,389.00	74219	POA
	6" x 5" x 3"	74210	POA	74220	POA
	6" x 5" x 4"	74211	POA	74221	POA
	8" x 6" x 4"	74212	POA	74222	\$4,630.50
	8" x 6" x 8"	75746	\$8,657.00	74223	\$9,532.00

Wye is segmentally welded.

 Orders for items in shaded areas **cannot** be cancelled or returned.

Technical Data Sheet: G180

Mechanical Products Section 2 – Couplings & Fittings



#330 Grooved Tee Wye

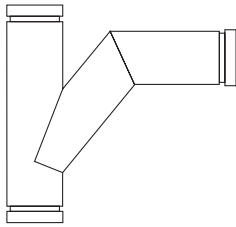

Nominal Size	Painted	List Price	Galvanized	List Price
2" x 2" x 2"	75730	\$990.00	3302020GS	\$1,174.50
2 1/2" x 2 1/2" x 2 1/2"	75731	\$990.00	3302525GS	\$1,178.50
3" x 3" x 3"	75732	\$1,135.00	73979	\$1,369.00
4" x 4" x 3"	73957	\$1,366.50	73980	\$1,654.00
4" x 4" x 4"	75735	\$1,575.00	73981	\$1,914.50
5" x 5" x 3"	3305030S	\$1,977.50	3305030GS	\$2,318.00
5" x 5" x 4"	3305040S	\$2,279.00	73983	\$2,545.00
5" x 5" x 5"	75738	\$3,349.00	3305050GS	\$4,090.50
6" x 6" x 3"	3306030S	\$1,620.00	3306030GS	\$2,091.00
6" x 6" x 4"	3306040S	\$1,974.00	73986	\$2,467.00
6" x 6" x 5"	73962	POA	73987	POA
6" x 6" x 6"	75742	\$3,002.00	73988	\$3,712.50
8" x 8" x 3"	3308030S	\$1,929.00	73989	\$2,801.50
8" x 8" x 4"	3308040S	\$2,298.00	73990	\$3,166.50
8" x 8" x 5"	3308050S	\$3,041.00	3308050GS	\$3,999.50
8" x 8" x 6"	3308060S	\$3,316.50	73992	\$4,336.50
8" x 8" x 8"	75759	\$4,569.00	73993	\$5,792.50
10" x 10" x 3"	3301030S	\$2,558.50	3301030GS	\$3,546.50
10" x 10" x 4"	3301040S	\$2,805.50	73995	\$3,852.50
10" x 10" x 5"	73969	POA	73996	\$4,698.50
10" x 10" x 6"	73970	\$3,721.00	73997	\$4,936.00
10" x 10" x 8"	73971	\$4,827.00	73998	\$6,209.50
10" x 10" x 10"	75752	\$6,304.00	3301010GS	\$8,082.50
12" x 12" x 3"	73972	POA	3301230GS	POA
12" x 12" x 4"	73973	POA	72032	POA
12" x 12" x 6"	3301260S	POA	3301260GS	POA
12" x 12" x 8"	3301280S	POA	3301280GS	POA
12" x 12" x 10"	3301210S	POA	72035	POA
12" x 12" x 12"	75758	\$8,691.00	3301212GS	\$11,035.00

Wye is segmentally welded.

Orders for items in shaded areas *cannot* be cancelled or returned.

Technical Data Sheet: G180

Introduction
 Couplings & Fittings
 Mechanical Tees
 Valves
 Circuit/Balancing Valves
 Accessories
 Copper Systems
 Stainless Steel Systems
 Plain End Systems
 Stainless Steel G-PRESS
 HDPE Systems
 Gaskets & Spare Parts
 Preparation Equipment
 Miscellaneous
 Indices

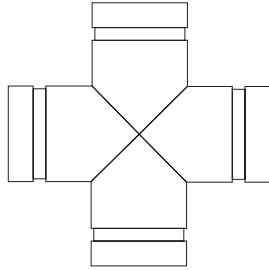
#327 – Grooved Cross

<i>Nominal Size</i>	<i>Painted</i>	<i>List Price</i>	<i>Galvanized</i>	<i>List Price</i>
1 1/4"	32713S	\$429.00	32713GS	\$499.50
1 1/2"	73729	\$462.00	32715GS	\$535.50
2"	75840	\$264.00	75849	\$314.50
2 1/2"	75841	\$264.00	75850	\$314.50
3"	75842	\$469.50	75851	\$574.00
4"	75843	\$777.00	75852	\$956.50
5"	73730	\$1,584.00	32750GS	\$1,908.00
6"	75845	\$2,031.50	75853	\$2,466.50
8"	75846	\$2,676.50	76757	\$3,311.00
10"	75847	\$4,390.00	76758	\$5,430.50
12"	75848	\$6,335.50	76759	\$7,892.00
14"	32714S	\$3,966.00	32714GS	\$5,427.50
16"	32716S	\$5,718.50	73743	\$6,601.00
18"	32718S	\$6,975.00	32718GS	\$8,060.50
20"	32721S	\$8,324.50	32721GS	\$11,968.00
24"	32724S	\$12,093.50	32724GS	\$16,878.00

Cross is segmentally welded.

Orders for items in shaded areas **cannot** be cancelled or returned.

Technical Data Sheet: G180

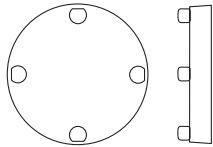
#260 and #360 – Grooved Cap

<i>Nominal Size</i>	<i>Painted</i>	<i>List Price</i>	<i>Galvanized</i>	<i>List Price</i>
1" *	26001S	\$82.00	26001GS	\$97.00
1 1/4" *	26013S	\$82.00	26013GS	\$97.00
1 1/2" *	26015S	\$82.00	26015GS	\$97.00
2" *	26020S	\$82.00	26020GS	\$97.00
2 1/2" *	26025S	\$82.00	26025GS	\$97.00
3" *	26030S	\$82.00	26030GS	\$97.00
4" *	26040S	\$87.50	26040GS	\$114.50
5" *	26050S	\$203.00	26050GS	\$271.50
6" *	26060S	\$202.50	26060GS	\$271.50
8" *	26080S	\$386.00	26080GS	\$511.00
10" *	26010S	\$675.50	26010GS	\$844.50
12" *	26012S	\$1,181.50	26012GS	\$1,477.00
14"	73807	\$1,568.00	75488	\$1,794.50
16"	73803	\$1,774.00	73808	\$2,118.50
18"	73804	\$2,053.50	73809	\$2,426.50
20"	73805	\$2,332.00	73810	\$2,785.50
24"	73806	\$3,175.50	73811	\$3,672.00

Cap is segmentally welded except where a * indicates it is available as a cast fitting.

Orders for items in shaded areas **cannot** be cancelled or returned.

Technical Data Sheet: G180

Mechanical Products Section 2 – Couplings & Fittings

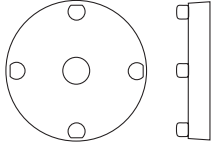

#260 Cast – Grooved Cap with 1/2" Tap

	Nominal Size	Painted	List Price
	1 1/4"	26013TS	POA
	1 1/2"	26015TS	POA
	2"	26020TS	\$416.50
	2 1/2"	26025TS	\$421.00
	3"	26030TS	\$421.00
	4"	26040TS	\$428.00
	5"	26050TS	POA
	6"	26060TS	\$588.50
	8"	26080TS	\$867.50
	10"	26010TS	POA
	12"	26012TS	POA

Orders for items in shaded areas **cannot** be cancelled or returned.

Technical Data Sheet: G180

#260 Cast – Grooved Cap with 3/4" Tap

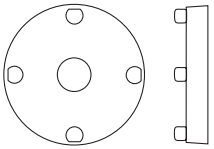
	Nominal Size	Painted	List Price
	2"	26020T75S	\$415.00
	2 1/2"	26025T75S	POA
	3"	26030T75S	POA
	4"	26040T75S	POA
	5"	26050T75S	POA
	6"	26060T75S	\$587.00
	8"	26080T75S	\$701.50
	10"	26010T75S	\$1,346.00
	12"	26012T75S	\$1,557.50

Orders for items in shaded areas **cannot** be cancelled or returned.

Technical Data Sheet: G180

#260 Cast – Grooved Cap with 1" Tap

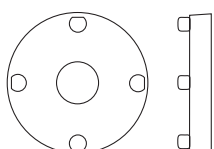
	Nominal Size	Painted	List Price
	2"	26020T1S	\$416.50
	2 1/2"	26025T1S	POA
	3"	26030T1S	\$555.00
	4"	26040T1S	\$535.00
	5"	26050T1S	POA
	6"	26060T1S	\$588.50
	8"	26080T1S	\$703.50
	10"	26010T1S	POA
	12"	26012T1S	POA

Orders for items in shaded areas **cannot** be cancelled or returned.

Technical Data Sheet: G180

Introduction
Couplings & Fittings
Mechanical Tees
Valves
Circuit Balancing Valves
Accessories
Copper Systems
Stainless Steel Systems
Plain End Systems
Stainless Steel G-PRESS
HDPE Systems
Gaskets & Spare Parts
Preparation Equipment
Miscellaneous
Indices

#341 Groove x Flange – Adapter 150#

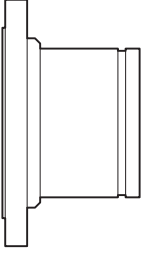
	<i>Nominal Size</i>	<i>Painted</i>	<i>List Price</i>	<i>Galvanized</i>	<i>List Price</i>
	1¼"	74240	POA	74245	POA
	1½"	74241	\$401.00	34115GS	\$633.00
	2"	73230	\$401.00	34120GS	\$633.00
	2½"	73231	\$799.50	73251	\$942.00
	3"	73232	\$819.00	73252	\$973.00
	4"	73233	\$936.00	73253	\$1,359.50
	5"	73234	\$1,291.50	73254	\$1,787.50
	6"	73235	\$1,314.50	73255	\$1,813.50
	8"	73236	\$1,627.00	73256	\$2,421.50
	10"	73237	\$2,465.50	74265	\$3,695.00
	12"	73238	\$3,374.00	74254	\$4,871.50
	14"	73239	\$4,234.00	34114GS	\$4,709.50
	16"	73240	\$5,045.50	34116GS	\$5,857.50
	18"	73241	\$5,585.50	34118GS	\$6,080.50
20"	73242	\$5,859.00	34121GS	\$6,339.50	
24"	73243	\$6,134.50	74259	\$6,600.00	

Adapter is segmentally welded.

Raised face flanges are standard; flat flanges are quoted on application.

Orders for items in shaded areas *cannot* be cancelled or returned.

Technical Data Sheet: G180

#342 Groove x Flange – Adapter 300#

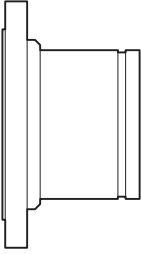
	<i>Nominal Size</i>	<i>Painted</i>	<i>List Price</i>	<i>Galvanized</i>	<i>List Price</i>
	1¼"	74260	POA	74276	\$578.50
	1½"	34215S	\$461.00	34215GS	POA
	2"	34220S	\$493.50	74278	\$580.50
	2½"	74263	\$491.50	34225GS	\$578.50
	3"	74264	\$685.00	34230GS	\$866.50
	4"	73260	\$1,288.00	34240GS	\$1,473.00
	5"	73261	\$1,314.50	73264	POA
	6"	73262	\$1,319.00	74283	\$1,984.50
	8"	74268	\$2,696.50	34280GS	\$3,195.50
	10"	34210S	\$3,341.00	34210GS	POA
	12"	34212S	\$5,014.50	34212GS	\$8,801.00
	14"	34214S	POA	34214GS	POA
	16"	34216S	POA	34216GS	POA
	18"	34218S	POA	34218GS	POA
20"	34221S	POA	34221GS	POA	
24"	34224S	POA	34224GS	POA	

Adapter is segmentally welded.

Raised face flanges are standard; flat flanges are quoted on application.

Orders for items in shaded areas *cannot* be cancelled or returned.

Technical Data Sheet: G180

Mechanical Products Section 2 – Couplings & Fittings



#397 Groove x Groove – Swaged Nipple

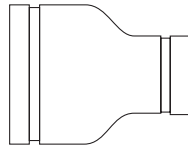

<i>Nominal Size</i>	<i>Painted</i>	<i>List Price</i>
2" x 1"	76840	\$414.00
2" x 1 ¹ / ₄ "	76841	\$414.00
2" x 1 ¹ / ₂ "	76842	\$414.00
2 ¹ / ₂ " x 1"	76843	\$889.50
2 ¹ / ₂ " x 1 ¹ / ₄ "	76844	\$889.50
2 ¹ / ₂ " x 1 ¹ / ₂ "	76845	\$889.50
2 ¹ / ₂ " x 2"	76846	\$790.50
3" x 1"	76847	\$991.50
3" x 1 ¹ / ₄ "	76848	\$991.50
3" x 1 ¹ / ₂ "	76849	\$991.50
3" x 2"	76850	\$833.00
3" x 2 ¹ / ₂ "	76851	\$833.00
3 ¹ / ₂ " x 3"	76852	\$1,903.50
4" x 1"	76853	\$1,409.00
4" x 1 ¹ / ₄ "	76854	\$1,409.00
4" x 1 ¹ / ₂ "	76855	\$1,080.50
4" x 2"	76856	\$1,080.50
4" x 2 ¹ / ₂ "	76857	\$1,238.00
4" x 3"	76858	\$1,238.00
5" x 1 ¹ / ₂ "	3975015S	POA
5" x 2"	76860	\$1,752.00
5" x 2 ¹ / ₂ "	3975025S	POA
5" x 3"	76861	\$1,752.00
5" x 4"	76862	\$1,752.00
6" x 1"	76863	\$3,491.50
6" x 1 ¹ / ₄ "	76864	\$3,491.50
6" x 1 ¹ / ₂ "	76865	\$3,491.50
6" x 2"	76866	\$2,856.00
6" x 2 ¹ / ₂ "	76867	\$2,856.00
6" x 3"	76868	\$2,856.00
6" x 4"	76870	\$1,711.00
6" x 5"	76871	\$1,711.00
8" x 6"	3978060S	\$3,258.00

Nipple is segmentally welded.

Orders for items in shaded areas **cannot** be cancelled or returned.

Technical Data Sheet: G180

Introduction
Couplings & Fittings
Mechanical Tees
Valves
Circuit Balancing Valves
Accessories
Copper Systems
Stainless Steel Systems
Plain End Systems
Stainless Steel G-PRESS
HDPE Systems
Gaskets & Spare Parts
Preparation Equipment
Miscellaneous
Indices

#398 Groove x Male Thread – Swaged Nipple

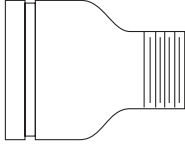
	<i>Nominal Size</i>	<i>Painted</i>	<i>List Price</i>
	2" x 1"	77001	\$414.00
	2" x 1 ¹ / ₄ "	77002	\$414.00
	2" x 1 ¹ / ₂ "	77003	\$414.00
	2 ¹ / ₂ " x 1"	77004	\$889.50
	2 ¹ / ₂ " x 1 ¹ / ₄ "	77005	\$889.50
	2 ¹ / ₂ " x 1 ¹ / ₂ "	77006	\$889.50
	2 ¹ / ₂ " x 2"	77007	\$790.50
	3" x 1"	77008	\$991.50
	3" x 1 ¹ / ₄ "	77009	\$991.50
	3" x 1 ¹ / ₂ "	77010	\$991.50
	3" x 2"	77011	\$833.00
	3" x 2 ¹ / ₂ "	77012	\$833.00
	3 ¹ / ₂ " x 3"	77013	\$1,903.50
	4" x 1"	77014	\$1,409.00
	4" x 1 ¹ / ₄ "	77015	\$1,409.00
	4" x 1 ¹ / ₂ "	77016	\$1,080.50
	4" x 2"	77017	\$1,080.50
	4" x 2 ¹ / ₂ "	77018	\$1,238.00
	4" x 3"	77019	\$1,238.00
	5" x 1 ¹ / ₂ "	3985015S	POA
	5" x 2"	77021	\$1,752.00
	5" x 2 ¹ / ₂ "	3985025S	POA
	5" x 3"	77022	\$1,752.00
	5" x 4"	77023	\$1,752.00
	6" x 1"	77024	\$3,491.50
	6" x 1 ¹ / ₄ "	77025	\$3,491.50
	6" x 1 ¹ / ₂ "	77026	\$3,491.50
	6" x 2"	77027	\$2,856.00
	6" x 2 ¹ / ₂ "	77028	\$2,856.00
	6" x 3"	77029	\$2,856.00
6" x 4"	77031	\$1,711.00	
6" x 5"	77032	\$1,711.00	
8" x 6"	3988060S	\$3,258.00	

Nipple is segmentally welded.

 Orders for items in shaded areas **cannot** be cancelled or returned.

Technical Data Sheet: G180

Mechanical Products Section 2 – Couplings & Fittings



#399 Groove x Plain – Swaged Nipple

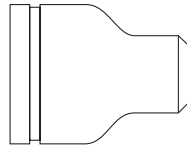

Nominal Size	Painted	List Price
2" x 1"	76051	\$414.00
2" x 1 1/4"	76052	\$414.00
2" x 1 1/2"	76053	\$414.00
2 1/2" x 1"	76054	\$889.50
2 1/2" x 1 1/4"	76055	\$889.50
2 1/2" x 1 1/2"	76056	\$889.50
2 1/2" x 2"	76057	\$790.50
3" x 1"	76058	\$991.50
3" x 1 1/4"	76059	\$991.50
3" x 1 1/2"	76060	\$991.50
3" x 2"	76061	\$833.00
3" x 2 1/2"	76062	\$833.00
3 1/2" x 3"	76063	\$1,897.00
4" x 1"	76064	\$1,409.00
4" x 1 1/4"	76065	\$1,404.50
4" x 1 1/2"	76066	\$1,080.50
4" x 2"	76067	\$1,080.50
4" x 2 1/2"	76068	\$1,238.00
4" x 3"	76069	\$1,238.00
5" x 1 1/2"	3995015S	POA
5" x 2"	76071	\$1,752.00
5" x 2 1/2"	3995025S	POA
5" x 3"	76072	\$1,752.00
5" x 4"	76073	\$1,752.00
6" x 1"	76074	\$3,491.50
6" x 1 1/4"	76075	\$3,491.50
6" x 1 1/2"	76076	\$3,491.50
6" x 2"	76077	\$2,856.00
6" x 2 1/2"	76078	\$2,856.00
6" x 3"	76079	\$2,856.00
6" x 4"	76081	\$1,711.00
6" x 5"	76082	\$1,711.00
8" x 6"	3998060S	\$3,258.00

Nipple is segmentally welded.

Orders for items in shaded areas **cannot** be cancelled or returned.

Technical Data Sheet: G180

- Introduction
- Couplings & Fittings
- Mechanical Tees
- Valves
- Circuit Balancing Valves
- Accessories
- Copper Systems
- Stainless Steel Systems
- Plain End Systems
- Stainless Steel G-PRESS
- HDPE Systems
- Gaskets & Spare Parts
- Preparation Equipment
- Miscellaneous
- Indices

#730 Mechanical Tee – Threaded with Grade “E” or Grade “T” Nitrile Gasket

Nominal Size	Painted			Galvanized		
	Grade “E” EPDM	Grade “T” Nitrile	List Price	Grade “E” EPDM	Grade “T” Nitrile	List Price
2" x 1/2"	7302005ES	7302005TS	\$89.00	7302005EGS	7302005TGS	\$112.00
2" x 3/4"	73020075ES	73020075TS	\$89.00	73020075EGS	73020075TGS	\$112.00
2" x 1"	7302010ES	7302010TS	\$89.00	7302010EGS	7302010TGS	\$112.00
2" x 1 1/4"	7302013ES	7302013TS	\$102.50	7302013EGS	7302013TGS	\$127.50
2" x 1 1/2"	7302015ES	7302015TS	\$102.50	7302015EGS	7302015TGS	\$127.50
2 1/2" x 1 1/2"	7302505ES	7302505TS	\$89.00	7302505EGS	7302505TGS	\$112.00
2 1/2" x 3/4"	73025075ES	73025075TS	\$89.00	73025075EGS	73025075TGS	\$112.00
2 1/2" x 1"	7302510ES	7302510TS	\$89.00	7302510EGS	7302510TGS	\$112.00
2 1/2" x 1 1/4"	7302513ES	7302513TS	\$125.00	7302513EGS	7302513TGS	\$152.00
2 1/2" x 1 1/2"	7302515ES	7302515TS	\$125.00	7302515EGS	7302515TGS	\$152.00
2 1/2" x 2"	7302520EP	7302520TP	\$125.00	7302520EGP	7302520TGP	\$152.00
3" x 1/2"	7303005ES	7303005TS	\$102.50	7303005EGS	7303005TGS	\$125.00
3" x 3/4"	73030075ES	73030075TS	\$102.50	73030075EGS	73030075TGS	\$125.00
3" x 1"	7303010ES	7303010TS	\$102.50	7303010EGS	7303010TGS	\$125.00
3" x 1 1/4"	7303013ES	7303013TS	\$129.50	7303013EGS	7303013TGS	\$162.00
3" x 1 1/2"	7303015ES	7303015TS	\$129.50	7303015EGS	7303015TGS	\$162.00
3" x 2"	7303020ES	7303020TS	\$149.00	7303020EGS	7303020TGS	\$184.50
4" x 1/2"	7304005ES	7304005TS	\$129.00	7304005EGS	7304005TGS	\$153.50
4" x 3/4"	73040075ES	73040075TS	\$129.00	73040075EGS	73040075TGS	\$153.50
4" x 1"	7304010ES	7304010TS	\$129.00	7304010EGS	7304010TGS	\$153.50
4" x 1 1/4"	7304013ES	7304013TS	\$151.00	7304013EGS	7304013TGS	\$178.00
4" x 1 1/2"	7304015ES	7304015TS	\$156.50	7304015EGS	7304015TGS	\$197.00
4" x 2"	7304020ES	7304020TS	\$156.50	7304020EGS	7304020TGS	\$199.00
4" x 2 1/2"	7304025ES	7304025TS	\$163.50	7304025EGS	7304025TGS	\$211.50
4" x 3"	7304030ES	7304030TS	\$174.00	7304030EGS	7304030TGS	\$223.50
5" x 1 1/2"	7305015EP	7305015TP	\$191.00	7305015EGP	7305015TGP	\$242.00
5" x 2"	7305020ES	7305020TS	\$191.00	7305020EGS	7305020TGS	\$242.00
5" x 2 1/2"	7305025ES	7305025TS	\$201.50	7305025EGS	7305025TGS	\$257.00
5" x 3"	7305030EP	7305030TP	\$214.50	7305030EGP	7305030TGP	\$276.00
6" x 1 1/4"	7306013EP	7306013TP	\$198.00	7306013EGP	7306013TGP	\$252.50
6" x 1 1/2"	7306015ES	7306015TS	\$196.00	7306015EGS	7306015TGS	\$250.50
6" x 2"	7306020ES	7306020TS	\$196.00	7306020EGS	7306020TGS	\$250.50
6" x 2 1/2"	7306025ES	7306025TS	\$211.00	7306025EGS	7306025TGS	\$272.50
6" x 3"	7306030ES	7306030TS	\$224.00	7306030EGS	7306030TGS	\$288.00
6" x 4"	7306040ES	7306040TS	\$248.50	7306040EGS	7306040TGS	\$323.00
8" x 2 1/2"	7308025ES	7308025TS	\$341.50	7308025EGS	7308025TGS	\$428.00
8" x 3"	7308030ES	7308030TS	\$360.50	7308030EGS	7308030TGS	\$457.00
8" x 4"	7308040ES	7308040TS	\$371.00	7308040EGS	7308040TGS	\$479.00

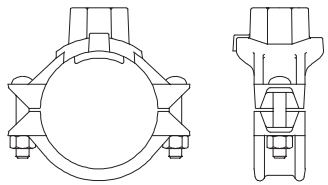

Orders for items in shaded areas *cannot* be cancelled or returned.

Technical Data Sheet: G210

Mechanical Products Section 3 – Mechanical Tees



#730 Mechanical Tee – Grooved with Grade “E” or Grade “T” Nitrile Gasket

Nominal Size	Painted			Galvanized		
	Grade “E” EPDM	Grade “T” Nitrile	List Price	Grade “E” EPDM	Grade “T” Nitrile	List Price
2" x 1 1/4"	7302013ERS	7302013TRS	\$102.50	7302013EGRS	7302013TGRS	\$127.50
2" x 1 1/2"	7302015ERS	7302015TRS	\$102.50	7302015EGRS	7302015TGRS	\$127.50
2 1/2" x 1 1/4"	7302513ERS	7302513TRS	\$125.00	7302513EGRS	7302513TGRS	\$152.00
2 1/2" x 1 1/2"	7302515ERS	7302515TRS	\$125.00	7302515EGRS	7302515TGRS	\$152.00
2 1/2" x 2"	7302520ERP	7302520TRP	POA	7302520EGRP	7302520TGRP	POA
3" x 1 1/4"	7303013ERS	7303013TRS	\$129.50	7303013EGRS	7303013TGRS	\$162.00
3" x 1 1/2"	7303015ERS	7303015TRS	\$129.50	7303015EGRS	7303015TGRS	\$162.00
3" x 2"	7303020ERS	7303020TRS	\$149.00	7303020EGRS	7303020TGRS	\$184.50
4" x 1 1/4"	7304013ERS	7304013TRS	\$151.00	7304013EGRS	7304013TGRS	\$178.00
4" x 1 1/2"	7304015ERS	7304015TRS	\$156.00	7304015EGRS	7304015TGRS	\$197.00
4" x 2"	7304020ERS	7304020TRS	\$156.50	7304020EGRS	7304020TGRS	\$199.00
4" x 2 1/2"	7304025ERS	7304025TRS	\$163.50	7304025EGRS	7304025TGRS	\$211.50
4" x 3"	7304030ERS	7304030TRS	\$174.00	7304030EGRS	7304030TGRS	\$223.50
5" x 1 1/2"	7305015ERP	7305015TRP	\$191.00	7305015EGRP	7305015TGRP	\$242.00
5" x 2"	7305020ERS	7305020TRS	\$191.00	7305020EGRS	7305020TGRS	\$242.00
5" x 2 1/2"	7305025ERS	7305025TRS	\$201.50	7305025EGRS	7305025TGRS	\$257.00
5" x 3"	7305030ERP	7305030TRP	\$214.50	7305030EGRP	7305030TGRP	\$276.00
6" x 1 1/4"	7306013ERP	7306013TRP	\$196.00	7306013EGRP	7306013TGRP	\$250.50
6" x 1 1/2"	7306015ERS	7306015TRS	\$196.00	7306015EGRS	7306015TGRS	\$250.50
6" x 2"	7306020ERS	7306020TRS	\$196.00	7306020EGRS	7306020TGRS	\$250.50
6" x 2 1/2"	7306025ERS	7306025TRS	\$214.50	7306025EGRS	7306025TGRS	\$272.50
6" x 3"	7306030ERS	7306030TRS	\$224.00	7306030EGRS	7306030TGRS	\$288.00
6" x 4"	7306040ERS	7306040TRS	\$248.50	7306040EGRS	7306040TGRS	\$323.00
8" x 2 1/2"	7308025ERS	7308025TRS	\$341.50	7308025EGRS	7308025TGRS	\$430.50
8" x 3"	7308030ERS	7308030TRS	\$360.50	7308030EGRS	7308030TGRS	\$457.00
8" x 4"	7308040ERS	7308040TRS	\$371.00	7308040EGRS	7308040TGRS	\$479.00

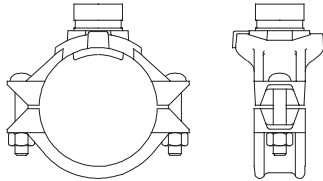

Orders for items in shaded areas *cannot* be cancelled or returned.

Technical Data Sheet: G210

Introduction
Couplings & Fittings
Mechanical Tees
Valves
Circuit Balancing Valves
Accessories
Copper Systems
Stainless Steel Systems
Plain End Systems
Stainless Steel G-PRESS
HDPE Systems
Gaskets & Spare Parts
Preparation Equipment
Miscellaneous
Indices

#730 Mechanical Cross – Threaded with Grade “E” or Grade “T” Nitrile Gasket

Nominal Size	Painted			Galvanized		
	Grade “E” EPDM	Grade “T” Nitrile	List Price	Grade “E” EPDM	Grade “T” Nitrile	List Price
2" x 1"	7302010ECS	7302010TCS	\$140.00	7302010EGCS	7302010TGCS	\$179.00
2" x 1 1/4"	7302013ECS	7302013TCS	\$160.00	7302013EGCS	7302013TGCS	\$205.00
2" x 1 1/2"	7302015ECS	7302015TCS	\$160.00	7302015EGCS	7302015TGCS	\$205.00
2 1/2" x 1"	7302510ECS	7302510TCS	\$140.00	7302510EGCS	7302510TGCS	\$179.00
2 1/2" x 1 1/4"	7302513ECS	7302513TCS	\$191.00	7302513EGCS	7302513TGCS	\$248.00
2 1/2" x 1 1/2"	7302515ECS	7302515TCS	\$191.50	7302515EGCS	7302515TGCS	\$264.00
3" x 1"	7303010ECS	7303010TCS	\$156.50	7303010EGCS	7303010TGCS	\$201.50
3" x 1 1/4"	7303013ECS	7303013TCS	\$191.50	7303013EGCS	7303013TGCS	\$239.50
3" x 1 1/2"	7303015ECS	7303015TCS	\$191.50	7303015EGCS	7303015TGCS	\$239.50
3" x 2"	7303020ECS	7303020TCS	\$221.50	7303020EGCS	7303020TGCS	\$274.50
4" x 3/4"	7304075ECS	7304075TCS	\$191.50	7304075EGCS	7304075TGCS	\$249.00
4" x 1"	7304010ECS	7304010TCS	\$191.50	7304010EGCS	7304010TGCS	\$249.00
4" x 1 1/4"	7304013ECS	7304013TCS	\$232.50	7304013EGCS	7304013TGCS	\$291.50
4" x 1 1/2"	7304015ECS	7304015TCS	\$232.50	7304015EGCS	7304015TGCS	\$291.50
4" x 2"	7304020ECS	7304020TCS	\$249.00	7304020EGCS	7304020TGCS	\$293.50
4" x 2 1/2"	7304025ECS	7304025TCS	\$249.00	7304025EGCS	7304025TGCS	\$316.00
4" x 3"	7304030ECS	7304030TCS	\$259.00	7304030EGCS	7304030TGCS	\$335.00
5" x 2"	7305020ECS	7305020TCS	\$284.50	7305020EGCS	7305020TGCS	\$360.50
5" x 2 1/2"	7305025ECS	7305025TCS	\$299.00	7305025EGCS	7305025TGCS	\$381.50
5" x 3"	7305030ECP	7305030TCP	\$320.50	7305030EGCP	7305030TGCP	\$411.00
6" x 1 1/2"	7306015ECS	7306015TCS	\$291.00	7306015EGCS	7306015TGCS	\$374.50
6" x 2"	7306020ECS	7306020TCS	\$303.50	7306020EGCS	7306020TGCS	\$404.00
6" x 2 1/2"	7306025ECS	7306025TCS	\$312.50	7306025EGCS	7306025TGCS	\$404.00
6" x 3"	7306030ECS	7306030TCS	\$334.00	7306030EGCS	7306030TGCS	\$428.00
6" x 4"	7306040ECS	7306040TCS	\$369.00	7306040EGCS	7306040TGCS	\$479.00
8" x 2 1/2"	7308025ECS	7308025TCS	\$510.50	7308025EGCS	7308025TGCS	\$644.00
8" x 3"	7308030ECS	7308030TCS	\$537.00	7308030EGCS	7308030TGCS	\$683.00
8" x 4"	7308040ECS	7308040TCS	\$555.50	7308040EGCS	7308040TGCS	\$718.00

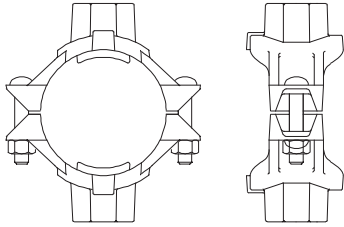

Orders for items in shaded areas *cannot* be cancelled or returned.

Technical Data Sheet: G210

Mechanical Products Section 3 – Mechanical Tees



#730 Mechanical Cross – Grooved with Grade “E” or Grade “T” Nitrile Gasket

	Nominal Size	Painted			Galvanized		
		Grade “E” EPDM	Grade “T” Nitrile	List Price	Grade “E” EPDM	Grade “T” Nitrile	List Price
	2" x 1 1/4"	7302013ERCS	7302013TRCS	\$160.00	7302013EGRCS	7302013TGRCS	\$205.00
	2" x 1 1/2"	7302015ERCS	7302015TRCS	\$160.00	7302015EGRCS	7302015TGRCS	\$205.00
	2 1/2" x 1 1/4"	7302513ERCS	7302513TRCS	\$191.50	7302513EGRCS	7302513TGRCS	\$248.00
	2 1/2" x 1 1/2"	7302515ERCS	7302515TRCS	\$191.50	7302515EGRCS	7302515TGRCS	\$264.00
	3" x 1 1/4"	7303013ERCS	7303013TRCS	\$191.50	7303013EGRCS	7303013TGRCS	\$239.50
	3" x 1 1/2"	7303015ERCS	7303015TRCS	\$191.50	7303015EGRCS	7303015TGRCS	\$239.50
	3" x 2"	7303020ERCS	7303020TRCS	\$221.50	7303020EGRCS	7303020TGRCS	\$274.50
	4" x 1 1/4"	7304013ERCS	7304013TRCS	\$223.50	7304013EGRCS	7304013TGRCS	\$291.50
	4" x 1 1/2"	7304015ERCS	7304015TRCS	\$232.50	7304015EGRCS	7304015TGRCS	\$291.50
	4" x 2"	7304020ERCS	7304020TRCS	\$249.00	7304020EGRCS	7304020TGRCS	\$293.50
	4" x 2 1/2"	7304025ERCS	7304025TRCS	\$249.00	7304025EGRCS	7304025TGRCS	\$316.00
	4" x 3"	7304030ERCS	7304030TRCS	\$259.00	7304030EGRCS	7304030TGRCS	\$335.00
	5" x 2"	7305020ERCS	7305020TRCS	\$284.50	7305020EGRCS	7305020TGRCS	\$360.50
	5" x 2 1/2"	7305025ERCS	7305025TRCS	\$299.00	7305025EGRCS	7305025TGRCS	\$381.50
	5" x 3"	7305030ERCS	7305030TRCS	\$320.50	7305030EGRCS	7305030TGRCS	\$411.00
	6" x 1 1/2"	7306015ERCS	7306015TRCS	\$291.00	7306015EGRCS	7306015TGRCS	\$374.50
	6" x 2"	7306020ERCS	7306020TRCS	\$303.50	7306020EGRCS	7306020TGRCS	\$404.00
	6" x 2 1/2"	7306025ERCS	7306025TRCS	\$312.50	7306025EGRCS	7306025TGRCS	\$404.00
	6" x 3"	7306030ERCS	7306030TRCS	\$334.00	7306030EGRCS	7306030TGRCS	\$428.00
	6" x 4"	7306040ERCS	7306040TRCS	\$369.00	7306040EGRCS	7306040TGRCS	\$479.00
8" x 2 1/2"	7308025ERCS	7308025TRCS	\$510.50	7308025EGRCS	7308025TGRCS	\$644.00	
8" x 3"	7308030ERCS	7308030TRCS	\$537.00	7308030EGRCS	7308030TGRCS	\$683.00	
8" x 4"	7308040ERCS	7308040TRCS	\$555.50	7308040EGRCS	7308040TGRCS	\$718.00	

Orders for items in shaded areas **cannot** be cancelled or returned.

Technical Data Sheet: G210

Introduction
Couplings & Fittings
Mechanical Tees
Valves
Circuit Balancing Valves
Accessories
Copper Systems
Stainless Steel Systems
Plain End Systems
Stainless Steel G-PRESS
HDPE Systems
Gaskets & Spare Parts
Preparation Equipment
Miscellaneous
Indices

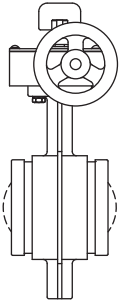
#B303 Grooved End Butterfly Valve – EPDM or Nitrile

Available with gear operator (shown)
or lever lock operator.
Specify choice when ordering.

Size	Lever Lock Operator Part #		List Price	Gear Operator Part #		List Price
	EPDM, with Lever	Nitrile, with Lever		EPDM, with Gear Op.	Nitrile, with Gear Op.	
2"	B30320EL	B30320TL	\$778.50	B30320EG	B30320TG	\$1,421.00
2½"	B30325EL	B30325TL	\$958.50	B30325EG	B30325TG	\$1,600.00
3"	B30330EL	B30330TL	\$1,000.00	B30330EG	B30330TG	\$1,641.50
4"	B30340EL	B30340TL	\$1,194.00	B30340EG	B30340TG	\$1,836.50
5"	B30350EL	B30350TL	\$2,126.50	B30350EG	B30350TG	\$2,768.50
6"	B30360EL	B30360TL	\$2,246.00	B30360EG	B30360TG	\$2,860.50
8"	B30380EL	B30380TL	\$2,920.00	B30380EG	B30380TG	\$3,535.50
10"	–	–	–	B30310EG	B30310TG	\$4,687.50
12"	–	–	–	B30312EG	B30312TG	\$5,197.00

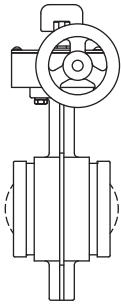
Technical Data Sheet: G315
#B303 Grooved End Butterfly Valve – Fluoroelastomer

Available with gear operator (shown)
or lever lock operator.
Specify choice when ordering.

Size	Lever Lock Operator		Gear Operator	
	Part #	List Price	Part #	List Price
2"	B30320LO	\$1,111.00	B30320GO	\$1,503.00
2½"	B30325LO	\$1,287.50	B30325GO	\$1,675.50
3"	B30330LO	\$1,428.50	B30330GO	\$1,751.00
4"	B30340LO	\$1,594.00	B30340GO	\$1,982.50
5"	B30350LO	\$3,056.00	B30350GO	\$2,956.00
6"	B30360LO	\$3,131.00	B30360GO	\$3,626.00
8"	B30380LO	\$4,023.00	B30380GO	\$4,801.00
10"	–	–	B30310GO	\$6,247.00
12"	–	–	B30312GO	\$6,972.00

 Orders for items in shaded areas **cannot** be cancelled or returned.

Technical Data Sheet: G315

Mechanical Products Section 4 – Valves



#B303 Grooved Butterfly Valve – Accessories

Size	Description	Part Number	List Price
2"	Mechanical BFV Gear Operator 2" & Bushing	GOH30320	\$1,120.50
2½"	Mechanical BFV Gear Operator 2½" & Bushing	GOH30325	\$1,120.50
3"	Mechanical BFV Gear Operator 3" & Bushing	GOH30330	\$1,120.50
4"	Mechanical BFV Gear Operator 4" & Bushing	GOH30340	\$1,120.50
5"	Mechanical BFV Gear Operator 5" & Bushing	GOH30350	\$1,120.50
6"	Mechanical BFV Gear Operator 6" & Bushing	GOH30360	\$1,120.50
8"	Mechanical BFV Gear Operator 8" & Bushing	GOH30380	\$1,120.50
10"	Mechanical BFV Gear Operator 10"	GOH30310	\$1,149.00
12"	Mechanical BFV Gear Operator 12"	GOH30312	\$1,149.00
2"	Mechanical BFV Lever Handle 2" & PLT	LH30320	\$259.50
2½"	Mechanical BFV Lever Handle 2½" & PLT	LH30325	\$259.50
3"	Mechanical BFV Lever Handle 3" & PLT	LH30330	\$259.50
4"	Mechanical BFV Lever Handle 4" & PLT	LH30340	\$294.50
5"	Mechanical BFV Lever Handle 5" & PLT	LH30350	\$294.50
6"	Mechanical BFV Lever Handle 6" & PLT	LH30360	\$294.50
8"	Mechanical BFV Lever Handle 8" & PLT	LH30380	\$294.50

Orders for items in shaded areas *cannot* be cancelled or returned.

Technical Data Sheet: G315

Introduction
Couplings & Fittings
Mechanical Tees
Valves
Circuit Balancing Valves
Accessories
Copper Systems
Stainless Steel Systems
Plain End Systems
Stainless Steel G-PRESS
HDPE Systems
Gaskets & Spare Parts
Preparation Equipment
Miscellaneous
Indices

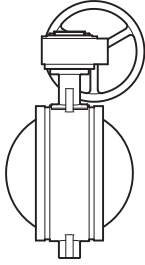
**Model B333 Grooved Butterfly Valve,
EPDM or Nitrile, Gear Operator**

	Size	Part Number		List Price
		EPDM	Nitrile	
	14"	B33314EG	B33314TG	\$6,562.50
	16"	B33316EG	B33316TG	\$8,977.50
	18"	B33318EG	B33318TG	\$11,049.00
	20"	B33320EG	B33320TG	\$14,951.00
	24"	B33324EG	B33324TG	\$19,039.00

Contact Tyco representative for availability

Orders for items in shaded areas **cannot** be cancelled or returned.

Technical Data Sheet: G325

Mechanical Products

Section 4 – Valves



Babbitt Valve Chainwheels

Cast Iron Standard Chainwheel			
Item No.	Hand Wheel Size	Part Number	List Price
0	2" to 4"	5036	\$258.00
1	4 ¹ / ₄ " to 5 ³ / ₄ "	5037	\$374.00
1.5	6" to 7 ¹ / ₂ "	5031	\$453.50
2	7 ³ / ₄ " to 9"	5038	\$599.00
2.5	9 ¹ / ₄ " to 12 ¹ / ₂ "	5039	\$859.00
3	12 ³ / ₄ " to 15 ¹ / ₂ "	5040	\$998.00
3.5	15 ³ / ₄ " to 19"	5041A	\$1,511.00
Epoxy Coated Corrosion Resistant Chainwheel			
0	2" to 4"	5025	\$558.50
1	4 ¹ / ₄ " to 5 ³ / ₄ "	5026	\$897.50
1.5	6" to 7 ¹ / ₂ "	5027	\$1,146.50
2	7 ³ / ₄ " to 9"	5028	\$1,407.50
2.5	9 ¹ / ₄ " to 12 ¹ / ₂ "	5033	\$1,822.00
3	12 ³ / ₄ " to 15 ¹ / ₂ "	5034	\$2,246.00
3.5	15 ³ / ₄ " to 19"	5035	\$2,771.50
Hot Dipped Galvanized Standard Chain			
Item No.	Part Number	List Price Per Foot	
0	5029	\$8.50	
1 to 2	5030	\$11.00	
2.5 to 3.5	5032	\$15.50	

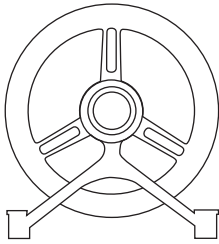

Orders for items in shaded areas **cannot** be cancelled or returned.

Introduction
 Couplings & Fittings
 Mechanical Tees
 Valves
 Circuit Balancing Valves
 Accessories
 Copper Systems
 Stainless Steel Systems
 Plain End Systems
 Stainless Steel G-PRESS
 HDPE Systems
 Gaskets & Spare Parts
 Preparation Equipment
 Miscellaneous
 Indices

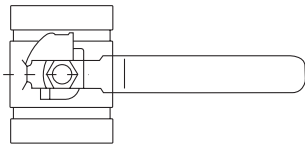
**#B8101 Low Profile Butterfly Valve
with Lever Handle**

<i>Size</i>	<i>Part Number</i>	<i>List Price</i>
2"	B810120E	\$682.00
2½"	B810125E	\$867.00
3"	B810130E	\$979.00
4"	B810140E	\$1,076.00
5"	B810150E	\$2,050.00
6"	B810160E	\$2,169.50

 Orders for items in shaded areas *cannot* be cancelled or returned.

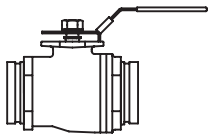
Technical Data Sheet: G330
BV835 Grooved Ball Valve

<i>Size</i>	<i>Lever Handle</i>		<i>Gear Operator</i>	
	<i>Part Number</i>	<i>List Price</i>	<i>Part Number</i>	<i>List Price</i>
1½"	BV83515	\$381.00	BV83515G	\$1,010.50
2"	BV83520	\$422.50	BV83520G	\$1,416.00
2½"	BV83525	\$920.00	BV83525G	\$1,859.00
3"	BV83530	\$1,485.50	BV83530G	\$2,633.00
4"	BV83540M	\$2,297.50	BV83540G	\$3,353.50
6"	BV83560	\$7,046.50	BV83560G	\$7,909.50

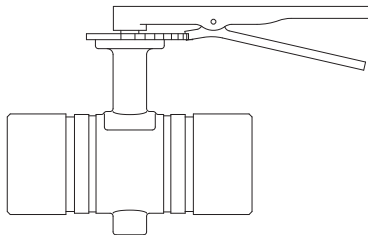
Technical Data Sheet: G380
**#B8200L Grooved Butterfly Valve – EPDM
(For Use In PVC Piping Systems)**

<i>Nominal Size</i>	<i>Part Number</i>	<i>List Price</i>
2"	B820020	\$421.50
3"	B820030	\$551.50
4"	B820040	\$709.50
6"	B820060	\$1,183.00
8"	B820080	\$1,414.00

 Orders for items in shaded areas *cannot* be cancelled or returned.

Technical Data Sheet: G592

#590 Grooved Check Valve, EPDM or Nitrile

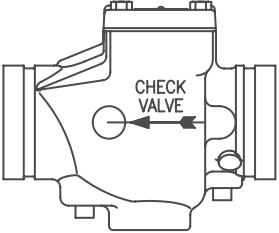

Size	EPDM Part Number		Nitrile Part Number		List Price
	Domestic	Import	Domestic	Import	
2"	59030020	59030020P	59030020T	59030020TP	\$696.00
2½"	59030025	59030025P	–	59030025TP	\$726.00
3"	59030030	59030030P	–	59030030TP	\$856.50
4"	59030040	59030040P	59030040T	59030040TP	\$905.00
5"	59030050	59030050P	–	59030050TP	\$1,503.50
6"	59030060	59030060P	59030060T	59030060TP	\$1,782.00
8"	59030080	59030080P	59030080T	59030080TP	\$2,434.00
10"	590300100	590300100P	–	590300100TP	\$6,513.00
12"	–	590300120P	–	590300120TP	\$7,717.00

Orders for items in shaded areas *cannot* be cancelled or returned.

Technical Data Sheet: G350

#CV890 Grooved Dual Disk Check Valve, EPDM or Nitrile

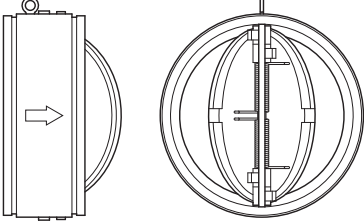

Size	Part Number		List Price
	EPDM	Nitrile	
14"	CV89014E	CV89014T	\$6,561.00
16"	CV89016E	CV89016T	\$8,942.50
18"	CV89018E	CV89018T	\$11,804.50
20"	CV89020E	CV89020T	\$15,517.00
24"	CV89024E	CV89024T	\$19,564.00

Orders for items in shaded areas *cannot* be cancelled or returned.

Technical Data Sheet: G354

#TD830, Triple Duty Valve, Flow Control Type

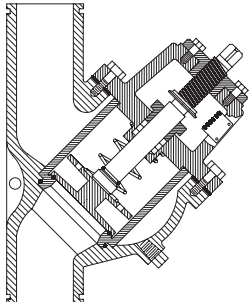

Size	Part Number	List Price
2"	TD83020	\$3,967.50
2½"	TD83025	\$4,019.00
3"	TD83030	\$4,372.50
4"	TD83040	\$5,995.00
5"	TD83050	\$6,560.00
6"	TD83060	\$9,817.50
8"	TD83080	\$14,576.00
10"	TD83010	\$24,341.00
12"	TD83012	\$34,438.50
14"	TD83014	\$53,151.00

Orders for items in shaded areas *cannot* be cancelled or returned.

Technical Data Sheet: G390

Introduction
Couplings & Fittings
Mechanical Tees
Valves
Circuit Balancing Valves
Accessories
Copper Systems
Stainless Steel Systems
Plain End Systems
Stainless Steel G-PRESS
HDPE Systems
Gaskets & Spare Parts
Preparation Equipment
Miscellaneous
Indices

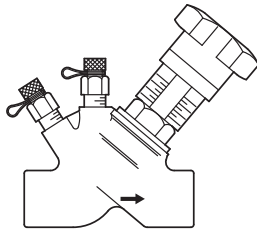
#CB800 Solder x Solder – Circuit Balancing Valve

<i>Size</i>	<i>Part #</i>	<i>List Price</i>
1/2"	CB8000501	\$102.00
3/4"	CB8000751	\$108.00
1"	CB8001001	\$144.00
1 1/4"	CB8001251	\$220.00
1 1/2"	CB8001501	\$254.00
2"	CB8002001	\$381.00

Technical Data Sheet: G450

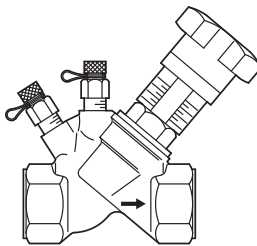
#CB800 Thread x Thread – Circuit Balancing Valve

<i>Size</i>	<i>Part #</i>	<i>List Price</i>
1/2"	CB8005002	\$100.00
3/4"	CB8000752	\$109.00
1"	CB8001002	\$146.00
1 1/4"	CB8001252	\$223.00
1 1/2"	CB8001502	\$257.00
2"	CB8002002	\$384.00

Technical Data Sheet: G450

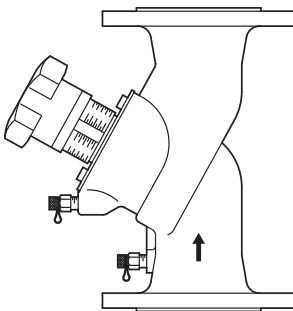
#CB800 Flange x Flange – Circuit Balancing Valve

<i>Size</i>	<i>Part Number</i>	<i>List Price</i>
2 1/2"	CB8002503	\$951.50
3"	CB8003003	\$1,453.50
4"	CB8004003	\$2,002.50
5"	CB8005003	\$3,583.00
6"	CB8006003	\$4,580.00
8"	CB8008003	\$9,896.50
10"	CB8001103	\$12,854.00
12"	CB8001203	\$26,911.50

Technical Data Sheet: G450

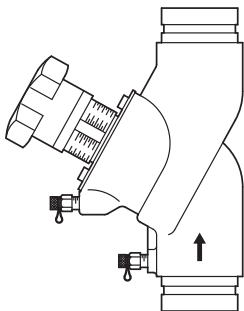
#CB800 Groove x Groove – Circuit Balancing Valve

<i>Size</i>	<i>Part Number</i>	<i>List Price</i>
2 1/2"	CB8002504	\$823.00
3"	CB8003004	\$1,279.00
4"	CB8004004	\$1,768.00
5"	CB8005004	\$3,199.00
6"	CB8006004	\$4,285.00
8"	CB8008004	\$9,127.50
10"	CB8001104	\$11,975.50
12"	CB8001204	\$26,022.50

Technical Data Sheet: G450

Mechanical Products Section 5 – Circuit Balancing Valves



#CB800 Circuit Balancing Valves – Accessories

	Description	Part Number	List Price
	Fill & Drain Ball Valve 1/4"	CBBV025	\$72.50
	Set of Two Pressure Test Points	CBTP02	\$120.50
	Set of One Pressure Test Point & One Fill & Drain Ball Valve	CBTK02	\$132.50
	Stem Extension 3/8" – 6", 1.38"	CBSE7560	\$66.00
	Hose BIB Kit	1659300	\$46.00
	CBV Needles	CBSR100	\$360.00
	Test Point Ext 80mm	CBTPX80	\$69.00
	Measuring Adapter	CBMA01	\$35.50

Orders for items in shaded areas **cannot** be cancelled or returned.

Technical Data Sheet: G450

Insulation Kits for #CB800 Circuit Balancing Valves

	Size	Part Number	List Price
	1/2"	CBIS050	\$30.00
	3/4"	CBIS075	\$30.00
	1"	CBIS010	\$32.50
	1 1/4"	CBIS125	\$36.50
	1 1/2"	CBIS150	\$40.00
	2"	CBIS200	\$48.50
	2 1/2"	CBIS250	\$536.00
	3"	CBIS300	\$596.00
	4"	CBIS400	\$662.00
	5"	CBIS500	\$739.50
6"	CBIS600	\$913.00	

Technical Data Sheet: G450

Differential Measuring Computer

	Description	Part #	List Price
	Differential Measuring Computer	CBMDMC2	\$8,589.00

Orders for items in shaded areas **cannot** be cancelled or returned.

Technical Data Sheet: G450

Introduction
Couplings & Fittings
Mechanical Tees
Valves
Circuit Balancing Valves
Accessories
Copper Systems
Stainless Steel Systems
Plain End Systems
Stainless Steel G-PRESS
HDPE Systems
Gaskets & Spare Parts
Preparation Equipment
Miscellaneous
Indices

#S853 Grooved Wye Strainer

Size	Painted		Galvanized	
	Part Number	List Price	Part Number	List Price
2"	S85320	\$1,727.00	S85320G	\$1,931.00
2½"	S85325	\$1,814.50	S85325G	\$2,054.50
3"	S85330	\$2,038.00	S85330G	\$2,342.50
4"	S85340	\$2,306.50	S85340G	\$2,726.00
5"	S85350	\$3,337.00	S85350G	\$3,975.00
6"	S85360	\$3,621.50	S85360G	\$4,458.00
8"	S85380	\$5,551.00	S85380G	\$6,946.50
10"	S85310	\$8,920.50	S85310G	\$11,197.00
12"	S85312	\$15,578.50	S85312G	\$18,932.50

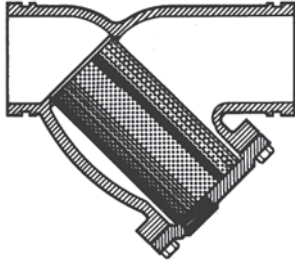
 Orders for items in shaded areas **cannot** be cancelled or returned.

Galvanized items have minimum order quantities of 10 pcs (2" thru 4") and 5 pcs (5" & larger) per line item or a small order charge of \$650.00 per line item will be assessed.

Technical Data Sheet: G420
#S855 Grooved Tee – Type Strainer

Size	Painted		Galvanized	
	Part Number	List Price	Part Number	List Price
2"	S85520	\$1,706.00	S85520G	\$2,000.00
2½"	S85525	\$1,792.50	S85525G	\$2,112.50
3"	S85530	\$2,011.50	S85530G	\$2,408.00
4"	S85540	\$2,276.50	S85540G	\$2,789.00
5"	S85550	\$3,297.00	S85550G	\$3,947.00
6"	S85560	\$3,576.50	S85560G	\$4,361.00
8"	S85580	\$5,482.00	S85580G	\$6,730.50
10"	S85510	\$8,048.00	S85510G	\$9,934.50
12"	S85512	\$10,360.00	S85512G	\$12,757.50

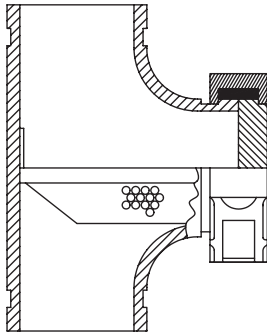
 Orders for items in shaded areas **cannot** be cancelled or returned.

Galvanized items have minimum order quantities of 10 pcs (2" thru 4") and 5 pcs (5" & larger) per line item or a small order charge of \$650.00 per line item will be assessed.

Technical Data Sheet: G430

#S810 Groove x Flange ANSI – Suction Diffuser

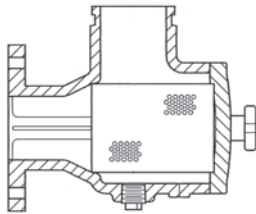

<i>Size</i>	<i>Part #</i>	<i>List Price</i>
3" x 2"	S8103020	\$3,508.50
3" x 2 1/2"	S8103025	\$2,523.00
3" x 3"	S8103030	\$2,556.50
4" x 2"	S8104020	POA
4" x 2 1/2"	S8104025	\$2,771.00
4" x 3"	S8104030	\$2,989.50
4" x 4"	S8104040	\$3,462.00
5" x 3"	S8105030	\$4,846.50
5" x 4"	S8105040	\$3,859.50
5" x 5"	S8105050	\$4,053.50
6" x 3"	S8106030	POA
6" x 4"	S8106040	\$4,114.50
6" x 5"	S8106050	\$4,920.00
6" x 6"	S8106060	\$5,109.00
8" x 5"	S8108050	\$5,240.00
8" x 6"	S8108060	\$5,525.50
8" x 8"	S8108080	\$9,507.00
10" x 6"	S8101060	\$9,870.00
10" x 8"	S8101080	\$10,726.00
10" x 10"	S8101010	\$12,923.00
12" x 8"	S8101280	\$13,531.50
12" x 10"	S8101210	\$15,297.00
12" x 12"	S8101212	\$21,275.00
14" x 10"	S8101410	\$15,699.50
14" x 12"	S8101412	\$17,537.50
14" x 14"	S8101414	\$21,296.50
16" x 14"	S8101614	\$21,918.00

Orders for items in shaded areas **cannot** be cancelled or returned.

Technical Data Sheet: G410

Introduction
Couplings & Fittings
Mechanical Tees
Valves
Circuit Balancing Valves
Accessories
Copper Systems
Stainless Steel Systems
Plain End Systems
Stainless Steel G-PRESS
HDPE Systems
Gaskets & Spare Parts
Preparation Equipment
Miscellaneous
Indices

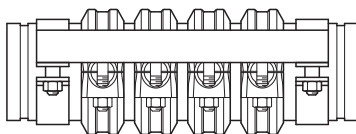
#7550 – Expansion Joint

Nominal Size	Number of Couplings per Expansion Joint	Movement (inches)			Painted Couplings and Black Pipe			Galvanized Couplings and Pipe		
		Maximum	Compressed	Expanded	Grade "E" EPDM	Grade "T" Nitrile	List Price	Grade "E" EPDM	Grade "T" Nitrile	List Price
1 1/4" with Fig. 705 Coupling	8	1.00	26.625	27.625	7550-1-13	7550-1-13T	POA	7550-1-13G	7550-1-13GT	POA
	10	1.25	31.375	32.625	7550-13-13	7550-13-13T	POA	7550-13-13G	7550-13-13GT	POA
	12	1.50	36.125	37.625	7550-15-13	7550-15-13T	POA	7550-15-13G	7550-15-13GT	POA
	14	1.75	40.875	42.625	7550-75-13	7550-75-13T	POA	7550-75-13G	7550-75-13GT	POA
1 1/2" with Fig. 705 Coupling	8	1.00	26.625	27.625	7550-1-15	7550-1-15T	POA	7550-1-15G	7550-1-15GT	POA
	10	1.25	31.375	32.625	7550-13-15	7550-13-15T	POA	7550-13-15G	7550-13-15GT	POA
	12	1.50	36.125	37.625	7550-15-15	7550-15-15T	POA	7550-15-15G	7550-15-15GT	POA
	14	1.75	40.875	42.625	7550-75-15	7550-75-15T	POA	7550-75-15G	7550-75-15GT	POA
2" with Fig. 705 Coupling	8	1.00	26.625	27.625	7550-1-20	7550-1-20T	POA	7550-1-20G	7550-1-20GT	POA
	10	1.25	31.375	32.625	7550-13-20	7550-13-20T	POA	7550-13-20G	7550-13-20GT	POA
	12	1.50	36.125	37.625	7550-15-20	7550-15-20T	POA	7550-15-20G	7550-15-20GT	POA
	14	1.75	40.875	42.625	7550-75-20	7550-75-20T	POA	7550-75-20G	7550-75-20GT	POA
2 1/2" with Fig. 705 Coupling	8	1.00	26.625	27.625	7550-1-25	7550-1-25T	POA	7550-1-25G	7550-1-25GT	POA
	10	1.25	31.375	32.625	7550-13-25	7550-13-25T	POA	7550-13-25G	7550-13-25GT	POA
	12	1.50	36.125	37.625	7550-15-25	7550-15-25T	POA	7550-15-25G	7550-15-25GT	POA
	14	1.75	40.875	42.625	7550-75-25	7550-75-25T	POA	7550-75-25G	7550-75-25GT	POA
3" with Fig. 705 Coupling	8	1.00	26.625	27.625	7550-1-30	7550-1-30T	POA	7550-1-30G	7550-1-30GT	POA
	10	1.25	31.375	32.625	7550-13-30	7550-13-30T	POA	7550-13-30G	7550-13-30GT	POA
	12	1.50	36.125	37.625	7550-15-30	7550-15-30T	POA	7550-15-30G	7550-15-30GT	POA
	14	1.75	40.875	42.625	7550-75-30	7550-75-30T	POA	7550-75-30G	7550-75-30GT	POA
4" with Fig. 705 Coupling	4	1.00	17.500	18.500	7550-1-40	7550-1-40T	POA	7550-1-40G	7550-1-40GT	POA
	5	1.25	20.000	21.250	7550-13-40	7550-13-40T	POA	7550-13-40G	7550-13-40GT	POA
	6	1.50	22.500	24.000	7550-15-40	7550-15-40T	POA	7550-15-40G	7550-15-40GT	POA
	7	1.75	25.000	26.750	7550-75-40	7550-75-40T	POA	7550-75-40G	7550-75-40GT	POA
5" with Fig. 705 Coupling	4	1.00	17.500	18.500	7550-1-50	7550-1-50T	POA	7550-1-50G	7550-1-50GT	POA
	5	1.25	20.000	21.250	7550-13-50	7550-13-50T	POA	7550-13-50G	7550-13-50GT	POA
	6	1.50	22.500	24.000	7550-15-50	7550-15-50T	POA	7550-15-50G	7550-15-50GT	POA
	7	1.75	25.000	26.750	7550-75-50	7550-75-50T	POA	7550-75-50G	7550-75-50GT	POA
6" with Fig. 705 Coupling	4	1.00	17.500	18.500	7550-1-60	7550-1-60T	POA	7550-1-60G	7550-1-60GT	POA
	5	1.25	20.000	21.250	7550-13-60	7550-13-60T	POA	7550-13-60G	7550-13-60GT	POA
	6	1.50	22.500	24.000	7550-15-60	7550-15-60T	POA	7550-15-60G	7550-15-60GT	POA
	7	1.75	25.000	26.750	7550-75-60	7550-75-60T	POA	7550-75-60G	7550-75-60GT	POA
8" with Fig. 705 Coupling	4	1.00	19.125	20.125	7550-1-80	7550-1-80T	POA	7550-1-80G	7550-1-80GT	POA
	5	1.25	22.000	23.250	7550-13-80	7550-13-80T	POA	7550-13-80G	7550-13-80GT	POA
	6	1.50	24.875	26.375	7550-15-80	7550-15-80T	POA	7550-15-80G	7550-15-80GT	POA
	7	1.75	27.500	29.500	7550-75-80	7550-75-80T	POA	7550-75-80G	7550-75-80GT	POA

See latest catalog or technical data sheets for specific approvals, listings, and design parameters.
POA = Price on availability. Prices subject to change without notice.

Customer Service: (800) 558-5236

#7550 – Expansion Joint

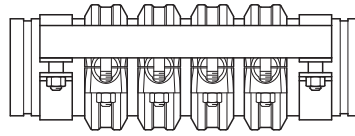

Nominal Size	Number of Couplings per Expansion Joint	Movement (inches)			Painted Couplings and Black Pipe			Galvanized Couplings and Pipe		
		Maximum	Compressed	Expanded	Grade "E" EPDM	Grade "T" Nitrile	List Price	Grade "E" EPDM	Grade "T" Nitrile	List Price
10" with Fig. 705 Coupling	4	1.00	21.500	22.500	7550-1-10	7550-1-10T	POA	7550-1-10G	7550-1-10GT	POA
	5	1.25	24.500	25.750	7550-13-10	7550-13-10T	POA	7550-13-10G	7550-13-10GT	POA
	6	1.50	27.500	29.000	7550-15-10	7550-15-10T	POA	7550-15-10G	7550-15-10GT	POA
	7	1.75	30.500	32.250	7550-75-10	7550-75-10T	POA	7550-75-10G	7550-75-10GT	POA
12" with Fig. 705 Coupling	4	1.00	21.500	22.500	7550-1-12	7550-1-12T	POA	7550-1-12G	7550-1-12GT	POA
	5	1.25	24.500	25.750	7550-13-12	7550-13-12T	POA	7550-13-12G	7550-13-12GT	POA
	6	1.50	27.500	29.000	7550-15-12	7550-15-12T	POA	7550-15-12G	7550-15-12GT	POA
	7	1.75	30.500	32.250	7550-75-12	7550-75-12T	POA	7550-75-12G	7550-75-12GT	POA
14" with Fig. 707 Coupling	4	1.00	23.125	24.125	7550-1-14	7550-1-14T	POA	7550-1-14G	7550-1-14GT	POA
	5	1.25	26.500	27.750	7550-13-14	7550-13-14T	POA	7550-13-14G	7550-13-14GT	POA
	6	1.50	29.875	31.375	7550-15-14	7550-15-14T	POA	7550-15-14G	7550-15-14GT	POA
	7	1.75	33.250	35.000	7550-75-14	7550-75-14T	POA	7550-75-14G	7550-75-14GT	POA
16" with Fig. 707 Coupling	4	1.00	24.125	25.125	7550-1-16	7550-1-16T	POA	7550-1-16G	7550-1-16GT	POA
	5	1.25	27.500	28.750	7550-13-16	7550-13-16T	POA	7550-13-16G	7550-13-16GT	POA
	6	1.50	30.875	32.375	7550-15-16	7550-15-16T	POA	7550-15-16G	7550-15-16GT	POA
	7	1.75	34.250	36.000	7550-75-16	7550-75-16T	POA	7550-75-16G	7550-75-16GT	POA

1. Factory present needs to be denoted at the time of sale as fully expanded, fully compressed, or intermediate % of movement from compressed position.
2. Expansion Joints can be provided with any of the following option combinations as a special order.

Gasket Material: "E" EPDM, "T" Nitrile, "O" Fluoroelastomer, or "L" Silicone

Pipe Finish: black, galvanized, or stainless steel

Coupling Finish: painted, galvanized, or stainless steel

For specific coupling specifications refer to appropriate coupling technical datasheet.

Consult with your Mechanical Products Sales representative before ordering.

Orders for items in shaded areas **cannot** be cancelled or returned.

Technical Data Sheet: G460

Introduction
Couplings & Fittings
Mechanical Tees
Valves
Circuit Balancing Valves
Accessories
Copper Systems
Stainless Steel Systems
Plain End Systems
Stainless Steel G-PRESS
HDPE Systems
Gaskets & Spare Parts
Preparation Equipment
Miscellaneous
Indices

**#640 Pivot-Bolt Rigid Couplings
with Grade “EHT” EPDM Center-Stop Push-On Style Gasket**

	<i>Nominal Size</i>	<i>Part Number</i>	<i>List Price</i>
	2"	64020EHT	\$66.50
	2½"	64025EHT	\$74.50
	3"	64030EHT	\$83.50
	4"	64040EHT	\$125.50
	5"	64050EHT	\$210.00
	6"	64060EHT	\$277.00
	8"	64080EHT	\$429.00

Technical Data Sheet: G512
**#672 Rigid Couplings
with Grade “EN” Tri-Seal Gasket**

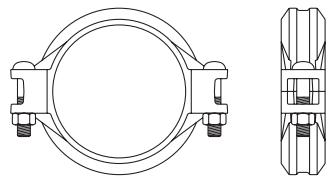
	<i>Nominal Size</i>	<i>Part Number</i>	<i>List Price</i>
	2"	67220EN3	\$66.50
	2½"	67225EN3	\$74.50
	3"	67230EN3	\$83.50
	4"	67240EN3	\$125.50
	5"	67250EN3	\$210.00
	6"	67260EN3	\$277.00
	8"	67280EN3	\$429.00

Technical Data Sheet: G510
**#616 Reducing Coupling
with Grade “EN” EPDM Gasket**

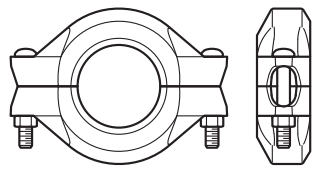
	<i>Nominal Size</i>	<i>Part Number</i>	<i>List Price</i>
	2½" x 2"	6162520ENP	\$266.00
	3" x 2"	6163020ENP	\$277.50
	3" x 2½"	6163025ENP	\$283.50
	4" x 2½"	6164025ENP	\$491.50
	4" x 3"	6164030ENP	\$503.00
	5" x 4"	6165040ENP	\$1,341.50
	6" x 4"	6166040ENP	\$1,445.50

Technical Data Sheet: G511

**#617 Transition Coupling for Joining IPS to Copper Tubing Systems
 with Grade “EN” EPDM Gasket**

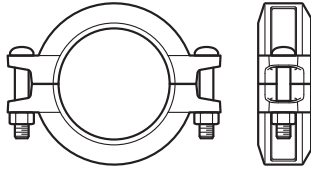

<i>Nominal Size</i>	<i>Part Number</i>	<i>List Price</i>
2"	61720ENP	\$341.00
2½"	61725ENP	\$347.00
3"	61730ENP	\$456.50
4"	61740ENP	\$867.00

Technical Data Sheet: G513

**#61H Flange Adapter – Hinged
 with Grade “EN” EPDM Gasket**

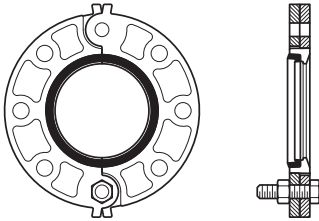

<i>Nominal Size</i>	<i>Part Number</i>	<i>List Price</i>
2"	61H20ENP	\$501.00
2½"	61H25ENP	\$522.00
3"	61H30ENP	\$546.50
4"	61H40ENP	\$599.00
5"	61H50ENP	\$805.50
6"	61H60ENP	\$876.50

Technical Data Sheet: G516

**#61 Flange Adapter
 with Grade “EN” EPDM Gasket**

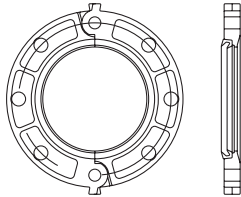

<i>Nominal Size</i>	<i>Part Number</i>	<i>List Price</i>
2"	6120EN	\$501.00
2½"	6125EN	\$522.00
3"	6130EN	\$546.50
4"	6140EN	\$599.00
5"	6150EN	\$805.50
6"	6160EN	\$876.50

Technical Data Sheet: G515

Introduction
 Couplings & Fittings
 Mechanical Tees
 Valves
 Circuit Balancing Valves
 Accessories
 Copper Systems
 Stainless Steel Systems
 Plain End Systems
 Stainless Steel G-PRESS
 HDPE Systems
 Gaskets & Spare Parts
 Preparation Equipment
 Miscellaneous
 Indices

#610 Grooved 90° Elbow

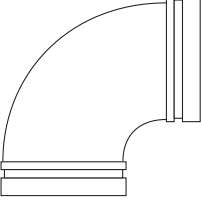
	Nominal Size	Part Number	List Price
	2"	61020S	\$120.50
	2½"	61025S	\$130.50
	3"	61030S	\$183.00
	4"	61040S	\$419.50
	5"	61050S	\$1,188.00
	6"	61060S	\$1,896.00
	8"	61080S	\$3,559.50

Technical Data Sheet: G520

#601 Grooved 45° Elbow

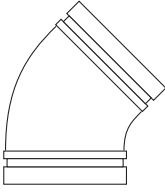
	Nominal Size	Part Number	List Price
	2"	64520S	\$120.50
	2½"	64525S	\$130.50
	3"	64530S	\$183.00
	4"	64540S	\$419.50
	5"	64550S	\$1,188.00
	6"	64560S	\$1,896.00
	8"	64580S	\$3,559.50

 Orders for items in shaded areas *cannot* be cancelled or returned.

Technical Data Sheet: G520

#619 Tee

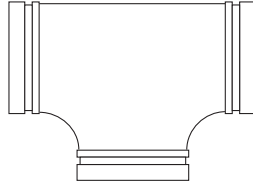
	Nominal Size	Part Number	List Price
	2"	61920S	\$197.50
	2½"	61925S	\$210.00
	3"	61930S	\$312.00
	4"	61940S	\$684.00
	5"	61950S	\$1,912.50
	6"	61960S	\$2,363.50
	8"	61980S	\$4,220.50

Technical Data Sheet: G520

#660 Cap

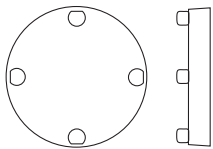
	Nominal Size	Part Number	List Price
	2"	66020S	\$83.50
	2½"	66025S	\$123.50
	3"	66030S	\$153.00
	4"	66040S	\$229.50
	5"	66050S	\$258.50
	6"	66060S	\$468.50
	8"	66080S	POA

 Orders for items in shaded areas *cannot* be cancelled or returned.

Technical Data Sheet: G520

Mechanical Products Section 7 – Copper Systems

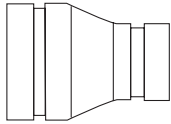

#650 Grooved Concentric Reducer

	Nominal Size	Part Number	List Price
	2½" x 2"	6502520	\$173.00
	3" x 2"	6503020	\$173.00
	3" x 2½"	6503025	\$173.00
	4" x 2"	6504020	\$353.50
	4" x 2½"	6504025	\$353.50
	4" x 3"	6504030	\$353.50
	5" x 3"	6505030	\$993.50
	5" x 4"	6505040	\$993.50
	6" x 3"	6506030	\$1,075.50
6" x 4"	6506040	\$1,075.50	
6" x 5"	6506050	\$1,075.50	
8" x 6"	6508060	\$1,887.50	

Orders for items in shaded areas *cannot* be cancelled or returned.

Technical Data Sheet: G520

#652 Grooved Reducer Grooved x Cup

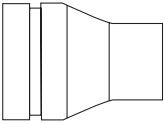
	Nominal Size	Part Number	List Price
	2" x 1"	6522010W	\$143.00
	2" x 1¼"	6522013W	\$143.00
	2" x 1½"	6522015W	\$143.00
	2½" x 1"	6522510W	\$175.00
	2½" x 1¼"	6522513W	\$175.00
	2½" x 1½"	6522515W	\$175.00
	2½" x 2"	6522520W	\$175.00
	3" x 1½"	6523015W	\$217.50
	3" x 2"	6523020W	\$217.50
4" x 2"	6524020W	\$403.50	

Technical Data Sheet: G520

#621 Reducing Tee Grooved x Grooved x Grooved

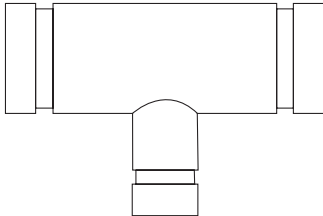
	Nominal Size	Part Number	List Price
	2½" x 2½" x 2"	6212520	\$312.50
	3" x 3" x 2"	6213020	\$402.50
	3" x 3" x 2½"	6213025	\$530.50
	4" x 4" x 2"	6214020	\$898.50
	4" x 4" x 2½"	6214025	\$898.50
	4" x 4" x 3"	6214030	\$898.50
	5" x 5" x 3"	6215030	\$2,741.50
	5" x 5" x 4"	6215040	\$2,741.50
	6" x 6" x 2½"	6216025	\$3,347.00
6" x 6" x 3"	6216030	\$3,347.00	
6" x 6" x 4"	6216040	\$3,347.00	
6" x 6" x 5"	6216050	\$3,347.00	

Orders for items in shaded areas *cannot* be cancelled or returned.

Technical Data Sheet: G520

Introduction
Couplings & Fittings
Mechanical Tees
Valves
Circuit Balancing Valves
Accessories
Copper Systems
Stainless Steel Systems
Plain End Systems
Stainless Steel G-PRESS
HDPE Systems
Gaskets & Spare Parts
Preparation Equipment
Miscellaneous
Indices

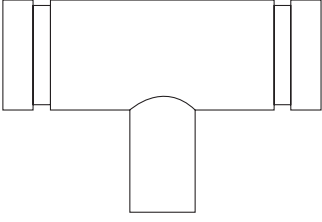
#618 Reducing Tee
Grooved x Grooved x Cup



	Nominal Size	Part Number	List Price
	2" x 2" x 3/4"	61820075	\$252.50
	2" x 2" x 1"	6182010	\$252.50
	2" x 2" x 1 1/4"	6182013	\$252.50
	2" x 2" x 1 1/2"	6182015	\$252.50
	2 1/2" x 2 1/2" x 3/4"	61825075	\$321.00
	2 1/2" x 2 1/2" x 1"	6182510	\$313.50
	2 1/2" x 2 1/2" x 1 1/4"	6182513	\$313.50
	2 1/2" x 2 1/2" x 1 1/2"	6182515	\$313.50
	3" x 3" x 3/4"	61830075	\$580.00
	3" x 3" x 1"	6183010	\$580.00
	3" x 3" x 1 1/4"	6183013	\$580.00
	3" x 3" x 1 1/2"	6183015	\$580.00
	4" x 4" x 3/4"	61840075	\$685.50
	4" x 4" x 1"	6184010	\$898.50
	4" x 4" x 1 1/4"	6184013	\$898.50
	4" x 4" x 1 1/2"	6184015	\$898.50

 Orders for items in shaded areas **cannot** be cancelled or returned.

Technical Data Sheet: G520
#407GG Dielectric Waterway Transition
Fitting Grooved x Grooved, IPS x CTS

	Nominal Size <i>(Pipe Size x Length)</i>	Part Number	List Price
	2" x 4" L	407GG20P	\$229.50
	2 1/2" x 4" L	407GG25P	\$257.00
	3" x 4" L	407GG30P	\$393.50
	4" x 4" L	407GG40P	\$789.00
	5" x 4" L	407GG50P	\$661.50
	6" x 4" L	407GG60P	\$819.00
	8" x 4" L	407GG80P	\$934.50

 Orders for items in shaded areas **cannot** be cancelled or returned.

Technical Data Sheet: G465
#407GT Dielectric Waterway
Grooved x Thread

	Nominal Size <i>(Pipe Size x Length)</i>	Painted	List Price
	1" x 4" L	41465	\$85.50
	1 1/4" x 4" L	41466	\$113.50
	1 1/2" x 4" L	41467	\$133.00
	2" x 4" L	41468	\$135.00
	2 1/2" x 6" L	41469	\$182.00
	3" x 6" L	41470	\$326.00
	4" x 6" L	41472	\$436.50

Technical Data Sheet: G465

**#407T Dielectric Waterway
Male Thread x Male Thread**

	<i>Nominal Size (Pipe Size x Length)</i>	<i>Painted</i>	<i>List Price</i>
	1/2" x 3" L	41455	\$47.00
	3/4" x 3" L	41456	\$47.00
	1" x 4" L	41457	\$70.50
	1 1/4" x 4" L	41458	\$98.50
	1 1/2" x 4" L	41459	\$118.50
	2" x 4" L	41460	\$135.00
	2 1/2" x 6" L	41461	\$182.00
	3" x 6" L	41462	\$326.00
	4" x 6" L	41464	\$436.50

Technical Data Sheet: G465

**#B680 Copper System Butterfly Valve
Grooved, EPDM, with Lever Handle or Gear Operated**

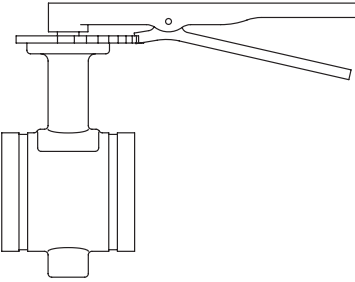
	<i>Nominal Size</i>	<i>Lever Handle</i>		<i>Gear Operated</i>	
		<i>Part Number</i>	<i>List Price</i>	<i>Part Number</i>	<i>List Price</i>
	2"	68020EL	POA	68020EG	POA
2 1/2"	68025EL	\$1,281.50	68025EG	\$2,099.00	
3"	68030EL	\$1,408.00	68030EG	\$2,223.50	
4"	68040EL	\$1,781.00	68040EG	\$2,598.00	
5"	68050EL	\$2,234.00	68050EG	\$3,053.00	
6"	68060EL	\$2,421.50	68060EG	\$3,235.50	

Orders for items in shaded areas *cannot* be cancelled or returned.

Technical Data Sheet: G530

**Roll Groover Mini-Mite 2" – 8" Copper Tube
#1039-66 Ratchet Hand Crank or Chucked into a Ridgid® 300**

	<i>Nominal Size</i>	<i>Part Number</i>	<i>List Price</i>
	2" – 8"	41047	\$916.50

Technical Data Sheet: G720

Introduction
Couplings & Fittings
Mechanical Tees
Valves
Circuit Balancing Valves
Accessories
Copper Systems
Stainless Steel Systems
Plain End Systems
Stainless Steel G-PRESS
HDPE Systems
Gaskets & Spare Parts
Preparation Equipment
Miscellaneous
Indices

#472 Rigid Coupling 316 SS
with Grade “EN” or Grade “T” Nitrile Gasket

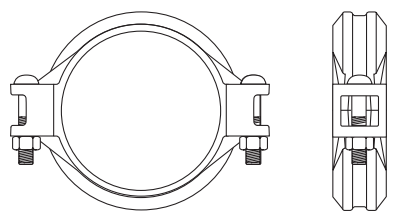
	Nominal Size	Part Number		List Price
		Grade “EN” EPDM	Grade “T” Nitrile	
	1 1/4"	47213EN	47213T	POA
	1 1/2"	47215EN	47215T	\$251.50
	2"	47220EN	47220T	\$281.00
	2 1/2"	47225EN	47225T	\$308.50
	3"	47230EN	47230T	\$344.50
	4"	47240EN	47240T	\$434.50
	5"	47250EN	47250T	POA
	6"	47260EN	47260T	\$1,002.00
	8"	47280EN	47280T	\$2,088.00
	10"	47210EN	47210T	\$2,460.50
	12"	47212EN	47212T	\$3,463.50

 Orders for items in shaded areas **cannot** be cancelled or returned.

Technical Data Sheet: G560
#472 Rigid Coupling 316 SS
with Grade “EN” or Grade “T” Nitrile Tri-seal Gasket

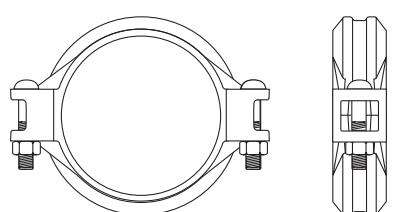
	Nominal Size	Part Number		List Price
		Grade “EN” EPDM	Grade “T” Nitrile	
	1 1/4"	47213EN3	47213T3	POA
	1 1/2"	47215EN3	47215T3	\$284.50
	2"	47220EN3	47220T3	\$327.50
	2 1/2"	47225EN3	47225T3	\$350.00
	3"	47230EN3	47230T3	\$384.00
	4"	47240EN3	47240T3	\$491.50
	5"	47250EN3	47250T3	POA
	6"	47260EN3	47260T3	\$1,350.00
	8"	47280EN3	47280T3	\$2,196.00
	10"	47210EN3	47210T3	\$2,599.00
	12"	47212EN3	47212T3	\$3,631.50

 Orders for items in shaded areas **cannot** be cancelled or returned.

Technical Data Sheet: G560

Mechanical Products Section 8 – Stainless Steel Systems



#405 Flexible Coupling 316 SS with Grade "EN" or Grade "T" Nitrile Gasket

	Nominal Size	Part Number		List Price
		Grade "EN" EPDM	Grade "T" Nitrile	
	1"	40501EN	40501T	\$193.00
	1 1/4"	40513EN	40513T	\$226.00
	1 1/2"	40515EN	40515T	\$251.50
	2"	40520EN	40520T	\$281.00
	2 1/2"	40525EN	40525T	\$308.50
	3"	40530EN	40530T	\$344.50
	4"	40540EN	40540T	\$434.50
	5"	40550EN	40550T	POA
	6"	40560EN	40560T	POA
	8"	40580EN	40580T	POA

Orders for items in shaded areas *cannot* be cancelled or returned.

Technical Data Sheet: G565

#405 Flexible Coupling 316 SS with Grade "EN" or Grade "T" Nitrile Tri-Seal Gasket

	Nominal Size	Part Number		List Price
		Grade "EN" EPDM	Grade "T" Nitrile	
	1 1/4"	40513EN3	40513T3	\$257.00
	1 1/2"	40515EN3	40515T3	\$284.00
	2"	40520EN3	40520T3	\$327.50
	2 1/2"	40525EN3	40525T3	\$350.00
	3"	40530EN3	40530T3	\$384.00
	4"	40540EN3	40540T3	\$491.50
	5"	40550EN3	40550T3	POA
	6"	40560EN3	40560T3	POA
	8"	40580EN3	40580T3	POA

Orders for items in shaded areas *cannot* be cancelled or returned.

Technical Data Sheet: G565

Introduction
 Couplings & Fittings
 Mechanical Tees
 Valves
 Circuit Balancing Valves
 Accessories
 Copper Systems
 Stainless Steel Systems
 Plain End Systems
 Stainless Steel G-PRESS
 HDPE Systems
 Gaskets & Spare Parts
 Preparation Equipment
 Miscellaneous
 Indices

#410 90° Elbow 304 SS & 316 SS, Schedule 10

Nominal Size	304 SS			316 SS		
	Domestic	Global	List Price	Domestic	Global	List Price
1"	410014AD	410014A	\$150.50	410016AD	410016A	\$158.00
1¼"	410134AD	410134A	\$130.50	410136AD	410136A	\$161.00
1½"	410154AD	410154A	\$130.50	410156AD	410156A	\$161.00
2"	410204AD	410204A	\$176.50	410206AD	410206A	\$181.00
2½"	410254AD	410254A	\$232.50	410256AD	410256A	\$245.00
3"	410304AD	410304A	\$236.50	410306AD	410306A	\$293.50
4"	410404AD	410404A	\$337.00	410406AD	410406A	\$419.50
5"	410504AD	410504A	POA	410506AD	410506A	POA
6"	410604AD	410604A	\$887.00	410606AD	410606A	\$1,107.00
8"	410804AD	410804A	\$1,541.00	410806AD	410806A	\$1,923.00
10"	410104AD	410104A	\$3,040.50	410106AD	410106A	\$3,799.00
12"	410124AD	410124A	\$4,764.50	410126AD	410126A	\$5,953.00

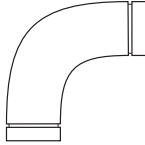

Orders for items in shaded areas *cannot* be cancelled or returned.
 Some sizes also available in Schedule 40. For price and availability, please contact your Grinnell Sales Representative.

Technical Data Sheet: G570

#401 45° Elbow, 304 SS & 316 SS, Schedule 10

Nominal Size	304 SS			316 SS		
	Domestic	Global	List Price	Domestic	Global	List Price
1"	401014AD	401014A	\$121.50	401016AD	401016A	\$143.50
1¼"	401134AD	401134A	\$121.50	401136AD	401136A	\$144.50
1½"	401154AD	401154A	\$126.50	401156AD	401156A	\$147.00
2"	401204AD	401204A	\$154.50	401206AD	401206A	\$161.50
2½"	401254AD	401254A	\$202.50	401256AD	401256A	\$212.00
3"	401304AD	401304A	\$218.00	401306AD	401306A	\$270.00
4"	401404AD	401404A	\$311.50	401406AD	401406A	\$386.50
5"	401504AD	401504A	POA	401506AD	401506A	POA
6"	401604AD	401604A	\$586.00	401606AD	401606A	\$731.50
8"	401804AD	401804A	\$1,001.00	401806AD	401806A	\$1,251.00
10"	401104AD	401104A	\$2,340.50	401106AD	401106A	\$2,737.50
12"	401124AD	401124A	\$3,229.50	401126AD	401126A	\$4,037.50

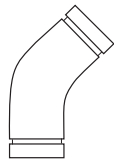

Orders for items in shaded areas *cannot* be cancelled or returned.
 Some sizes also available in Schedule 40. For price and availability, please contact your Grinnell Sales Representative.

Technical Data Sheet: G570

Mechanical Products Section 8 – Stainless Steel Systems

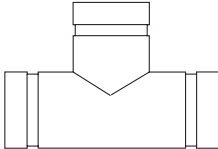

#419 Tee, 304 SS & 316 SS, Schedule 10

	Nominal Size	304 SS			316 SS		
		Domestic	Global	List Price	Domestic	Global	List Price
	1"	419014AD	419014A	\$471.00	419016AD	419016A	\$490.50
	1 1/4"	419134AD	419134A	\$552.00	419136AD	419136A	POA
	1 1/2"	419154AD	419154A	\$437.50	419156AD	419156A	\$458.00
	2"	419204AD	419204A	\$472.50	419206AD	419206A	\$479.50
	2 1/2"	419254AD	419254A	\$528.50	419256AD	419256A	\$584.00
	3"	419304AD	419304A	\$605.50	419306AD	419306A	\$756.00
	4"	419404AD	419404A	\$648.00	419406AD	419406A	\$809.50
	5"	419504AD	419504A	POA	419506AD	419506A	POA
	6"	419604AD	419604A	\$1,259.50	419606AD	419606A	\$1,766.00
	8"	419804AD	419804A	\$1,859.50	419806AD	419806A	\$3,283.00
	10"	419104AD	419104A	\$3,636.00	419106AD	419106A	\$8,385.00
	12"	419124AD	419124A	\$5,479.50	419126AD	419126A	\$10,689.50

Orders for items in shaded areas *cannot* be cancelled or returned.
 Some sizes also available in Schedule 40. For price and availability, please contact your Grinnell Sales Representative.

Technical Data Sheet: G570

#460 Cap, 304 SS & 316 SS, Schedule 10

	Nominal Size	304 SS			316 SS		
		Domestic	Global	List Price	Domestic	Global	List Price
	1"	460014AD	460014A	POA	460016AD	460016A	\$223.50
	1 1/4"	460134AD	460134A	POA	460136AD	460136A	\$236.50
	1 1/2"	460154AD	460154A	POA	460156AD	460156A	\$247.00
	2"	460204AD	460204A	POA	460206AD	460206A	\$339.00
	2 1/2"	460254AD	460254A	POA	460256AD	460256A	\$352.50
	3"	460304AD	460304A	POA	460306AD	460306A	\$427.00
	4"	460404AD	460404A	POA	460406AD	460406A	\$544.50
	5"	460504AD	460504A	POA	460506AD	460506A	POA
	6"	460604AD	460604A	POA	460606AD	460606A	\$650.00
	8"	460804AD	460804A	POA	460806AD	460806A	\$1,530.50
	10"	460104AD	460104A	POA	460106AD	460106A	\$2,003.00
	12"	460124AD	460124A	POA	460126AD	460126A	\$2,331.00

Orders for items in shaded areas *cannot* be cancelled or returned.
 Some sizes also available in Schedule 40. For price and availability, please contact your Grinnell Sales Representative.

Technical Data Sheet: G570

Introduction
Couplings & Fittings
Mechanical Tees
Valves
Circuit Balancing Valves
Accessories
Copper Systems
Stainless Steel Systems
Plain End Systems
Stainless Steel G-PRESS
HDPE Systems
Gaskets & Spare Parts
Preparation Equipment
Miscellaneous
Indices

#421 Reducing Tee, 304 SS & 316 SS, Schedule 10

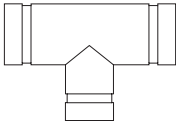
	Nominal Size	304 SS			316 SS		
		Domestic	Global	List Price	Domestic	Global	List Price
	1½" x 1½" x 1"	42115014AD	42115014A	\$413.50	42115016AD	42115016A	\$508.00
	1½" x 1½" x 1¼"	42115134AD	42115134A	\$422.50	42115136AD	42115136A	\$519.50
	2" x 2" x 1"	42120014AD	42120104A	\$445.50	42120016AD	42120016A	\$524.50
	2" x 2" x 1¼"	42120134AD	42120134A	\$500.50	42120136AD	42120136A	\$681.00
	2" x 2" x 1½"	42120154AD	42120154A	\$566.00	42120156AD	42120156A	\$681.00
	2½" x 2½" x 1"	42125014AD	42125104A	\$567.00	42125016AD	42125016A	\$696.00
	2½" x 2½" x 1½"	42125154AD	42125154A	\$640.00	42125156AD	42125156A	\$699.00
	2½" x 2½" x 2"	42125204AD	42125204A	\$672.50	42125206AD	42125206A	\$688.00
	3" x 3" x 1"	42130014AD	42130014A	\$567.50	42130016AD	42130016A	\$650.50
	3" x 3" x 1¼"	42130134AD	42130134A	\$672.00	42130136AD	42130136A	\$800.50
	3" x 3" x 1½"	42130154AD	42130154A	\$699.00	42130156AD	42130156A	\$840.50
	3" x 3" x 2"	42130204AD	42130204A	\$748.50	42130206AD	42130206A	POA
	3" x 3" x 2½"	42130254AD	42130254A	\$721.00	42130256AD	42130256A	\$897.50
	4" x 4" x 2"	42140204AD	42140204A	\$848.00	42140206AD	42140206A	\$1,014.50
	4" x 4" x 2½"	42140254AD	42140254A	\$950.00	42140256AD	42140256A	\$1,085.00
	4" x 4" x 3"	42140304AD	42140304A	\$995.50	42140306AD	42140306A	\$1,241.50
	6" x 6" x 1½"	42160154AD	42160154A	POA	42160156AD	42160156A	POA
	6" x 6" x 2"	42160204AD	42160204A	\$1,799.00	42160206AD	42160206A	\$2,117.00
6" x 6" x 3"	42160304AD	42160304A	\$1,283.00	42160306AD	42160306A	\$1,601.00	
6" x 6" x 4"	42160404AD	42160404A	\$1,590.00	42160406AD	42160406A	\$1,898.00	
8" x 8" x 4"	42180404AD	42180404A	\$3,745.00	42180406AD	42180406A	\$4,471.00	
8" x 8" x 6"	42180604AD	42180604A	\$4,909.50	42180606AD	42180606A	\$6,018.50	
10" x 10" x 6"	42110604AD	42110604A	\$5,990.00	42110606AD	42110606A	\$7,635.50	
10" x 10" x 8"	42110804AD	42110804A	\$6,043.00	42110806AD	42110806A	\$7,701.50	
12" x 12" x 8"	42112804AD	42112804A	\$8,633.00	42112806AD	42112806A	\$10,775.00	
12" x 12" x 10"	42112104AD	42112104A	\$10,319.50	42112106AD	42112106A	\$12,877.50	

Orders for items in shaded areas **cannot** be cancelled or returned.

Some sizes also available in Schedule 40. For price and availability, please contact your Grinnell Sales Representative.

Technical Data Sheet: G570

#441 Flange Adapter Nipple 150 lbs. 304 SS & 316 SS, Schedule 10

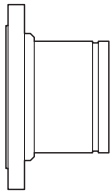
	Nominal Size	304 SS		316 SS	
		Part Number	List Price	Part Number	List Price
	2"	441204	\$792.50	441206	\$807.00
	2½"	441254	\$1,115.50	441256	\$1,204.00
	3"	441304	\$1,151.00	441306	\$1,242.50
	4"	441404	\$1,609.00	441406	\$1,737.00
	6"	441604	\$2,166.00	441606	\$2,316.50
	8"	441804	\$2,957.00	441806	\$3,544.00

Orders for items in shaded areas **cannot** be cancelled or returned.

Some sizes also available in Schedule 40. For price and availability, please contact your Grinnell Sales Representative.

Technical Data Sheet: G568

Mechanical Products

Section 8 – Stainless Steel Systems



#450 Concentric Reducer, 304 SS & 316 SS, Schedule 10

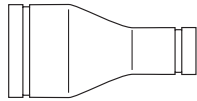

Nominal Size	304 SS			316 SS		
	Domestic	Global	List Price	Domestic	Global	List Price
1 1/2" x 1"	45015014AD	–	\$293.00	45015016AD	45015016A	\$340.50
1 1/2" x 1 1/4"	45015134AD	45015134A	\$325.00	45015136AD	45015136A	\$354.50
2" x 1"	45020014AD	45020104A	\$237.00	45020016AD	45020016A	\$280.00
2" x 1 1/4"	45020134AD	45020134A	\$657.50	45020136AD	45020136A	\$831.00
2" x 1 1/2"	45020154AD	45020154A	\$281.00	45020156AD	45020156A	\$322.00
2 1/2" x 1 1/2"	45025154AD	45025154A	\$635.00	45025156AD	45025156A	\$680.00
2 1/2" x 2"	45025204AD	45025204A	\$393.50	45025206AD	45025206A	\$404.00
3" x 1"	45030014AD	45030014A	\$677.50	45030016AD	45030016A	\$883.00
3" x 1 1/4"	45030134AD	45030134A	\$973.50	45030136AD	45030136A	POA
3" x 1 1/2"	45030154AD	45030154A	\$662.50	45030156AD	45030156A	\$790.50
3" x 2"	45030204AD	45030204A	\$211.50	45030206AD	45030206A	\$312.50
3" x 2 1/2"	45030254AD	45030254A	\$173.50	45030256AD	45030256A	\$215.50
4" x 2"	45040204AD	45040204A	\$282.00	45040206AD	45040206A	\$492.50
4" x 2 1/2"	45040254AD	45040254A	\$386.50	45040256AD	45040256A	\$726.50
4" x 3"	45040304AD	45040304A	\$200.50	45040306AD	45040306A	\$250.50
5" x 3"	45050304AD	45050304A	POA	45050306AD	45050306A	POA
5" x 4"	45050404AD	45050404A	POA	45050406AD	45050406A	POA
6" x 2"	45060204AD	45060204A	POA	45060206AD	45060206A	POA
6" x 2 1/2"	45060254AD	45060254A	\$3,240.50	45060256AD	45060256A	\$4,095.50
6" x 3"	45060304AD	45060304A	\$648.00	45060306AD	45060306A	\$808.00
6" x 4"	45060404AD	45060404A	\$492.50	45060406AD	45060406A	\$613.50
6" x 5"	45060504AD	45060504A	\$1,887.50	–	–	–
8" x 3"	45080304AD	45080304A	POA	45080306AD	45080306A	POA
8" x 4"	45080404AD	45080404A	\$2,358.00	45080406AD	45080406A	\$2,947.00
8" x 6"	45080604AD	45080604A	\$1,238.00	45080606AD	45080606A	\$1,544.00
10" x 4"	45010404AD	45010404A	\$3,879.00	45010406AD	45010406A	\$4,778.00
10" x 6"	45010604AD	45010604A	\$2,920.00	45010606AD	45010606A	\$3,650.00
10" x 8"	45010804AD	45010804A	\$3,262.50	45010806AD	45010806A	\$4,077.00
12" x 6"	45012604AD	45012604A	POA	45012606AD	45012606A	POA
12" x 8"	45012804AD	45012804A	\$4,444.00	45012806AD	45012806A	\$5,553.50
12" x 10"	45012104AD	45012104A	\$4,084.00	45012106AD	45012106A	\$5,102.50

Orders for items in shaded areas **cannot** be cancelled or returned.
Some sizes also available in Schedule 40. For price and availability, please contact your Grinnell Sales Representative.

Technical Data Sheet: G570

Introduction
Couplings & Fittings
Mechanical Tees
Valves
Circuit Balancing Valves
Accessories
Copper Systems
Stainless Steel Systems
Plain End Systems
Stainless Steel G-PRESS
HDPE Systems
Gaskets & Spare Parts
Preparation Equipment
Miscellaneous
Indices

#451 Eccentric Reducer, 304 SS & 316 SS, Schedule 10

Nominal Size	304 SS			316 SS		
	Domestic	Global	List Price	Domestic	Global	List Price
1 1/4" x 1"	45113014AD	45113014A	POA	45113016AD	45113016A	POA
1 1/2" x 1"	45115014AD	45115014A	\$638.50	45115016AD	45115016A	\$734.00
1 1/2" x 1 1/4"	45115134AD	45115134A	POA	45115136AD	45115136A	POA
2" x 1"	45120014AD	45120014A	\$1,277.50	45120016AD	45120016A	\$1,277.50
2" x 1 1/4"	45120134AD	45120134A	\$1,374.00	45120136AD	45120136A	\$1,466.00
2" x 1 1/2"	45120154AD	45120154A	\$725.00	45120156AD	45120156A	\$831.00
2 1/2" x 2"	45125204AD	45125204A	\$881.50	45125206AD	45125206A	\$1,074.50
3" x 1"	45130014AD	45130014A	POA	45130016AD	45130016A	POA
3" x 2"	45130204AD	45130204A	\$891.50	45130206AD	45130206A	\$970.50
3" x 2 1/2"	45130254AD	45130254A	\$905.50	45130256AD	45130256A	\$1,040.50
4" x 2"	45140204AD	45140204A	\$2,385.00	45140206AD	45140206A	\$3,458.00
4" x 2 1/2"	45140254AD	45140254A	\$1,111.50	45140256AD	45140256A	\$1,888.00
4" x 3"	45140304AD	45140304A	\$1,852.00	45140306AD	45140306A	\$2,311.50
5" x 3"	45150304AD	45150304A	POA	45150306AD	45150306A	POA
5" x 4"	45150404AD	45150404A	POA	45150406AD	45150406A	POA
6" x 2"	45160204AD	45160204A	POA	45160206AD	45160206A	POA
6" x 2 1/2"	45160254AD	45160254A	\$3,240.50	45160256AD	45160256A	POA
6" x 3"	45160304AD	45160304A	\$5,351.00	45160306AD	45160306A	POA
6" x 4"	45160404AD	45160404A	\$1,954.00	45160406AD	45160406A	\$2,858.00
8" x 3"	45180304AD	45180304A	POA	45180306AD	45180306A	POA
8" x 4"	45180404AD	45180404A	POA	45180406AD	45180406A	POA
8" x 6"	45180604AD	45180604A	POA	45180606AD	45180606A	POA
10" x 6"	45110604AD	45110604A	POA	45110606AD	45110606A	POA
10" x 8"	45110804AD	45110804A	POA	45110806AD	45110806A	POA
12" x 6"	45112604AD	45112604A	POA	45112606AD	45112606A	POA
12" x 8"	45112804AD	45112804A	POA	45112806AD	45112806A	POA
12" x 10"	45112104AD	45112104A	POA	45112106AD	45112106A	POA



Orders for items in shaded areas **cannot** be cancelled or returned.
 Some sizes also available in Schedule 40. For price and availability, please contact your Grinnell Sales Representative.

Technical Data Sheet: G570

**#B480 Stainless Steel Grooved Butterfly Valve
 EPDM or Nitrile, Lever Operator**

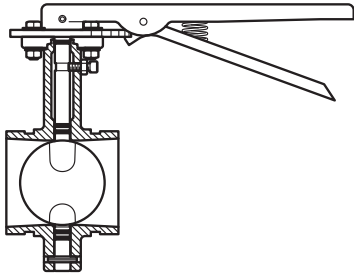

Size	EPDM		Nitrile	
	Part #	List Price	Part #	List Price
2"	B48020EL	\$1,320.00	B48020TL	\$1,320.00
2½"	B48025EL	\$1,626.50	B48025TL	\$1,626.50
76.1mm	B480761EL	\$1,626.50	B480761TL	\$1,626.50
3"	B48030EL	\$1,698.00	B48030TL	\$1,698.00
4"	B48040EL	\$2,026.00	B48040TL	\$2,026.00
165.1mm	B4801651EL	\$3,812.50	B4801651TL	\$3,812.50
6"	B48060EL	\$3,812.50	B48060TL	\$3,812.50

Orders for items in shaded areas **cannot** be cancelled or returned.

Technical Data Sheet: G340

BV435 Stainless Steel Grooved Ball Valve (600 psi)

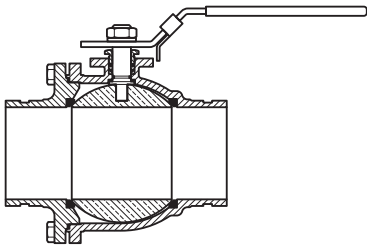

Size	Part Number	List Price
1½"	BV43515	\$892.00
2"	BV43520	\$1,049.50
2½"	BV43525	\$1,819.50
3"	BV43530	\$2,445.50
4"	BV43540	\$3,888.00

Technical Data Sheet: G370

Introduction
 Couplings & Fittings
 Mechanical Tees
 Valves
 Circuit Balancing Valves
 Accessories
 Copper Systems
 Stainless Steel Systems
 Plain End Systems
 Stainless Steel G-PRESS
 HDPE Systems
 Gaskets & Spare Parts
 Preparation Equipment
 Miscellaneous
 Indices

#909 Plain End Coupling
with Grade “E” EPDM Gasket or Grade “T” Nitrile Gasket

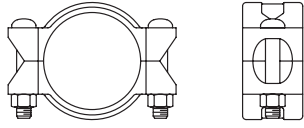
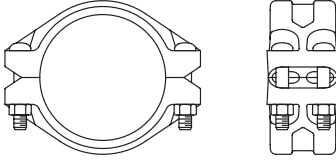
 Fig. 909 – 2" thru 6"	Nominal Size	Painted			Galvanized		
		Grade “E” EPDM Part No.	Grade “T” Nitrile Part No.	List Price	Grade “E” EPDM Part No.	Grade “T” Nitrile Part No.	List Price
 Fig. 909 – 8" thru 18"	2"	90920ES	90920TS	\$202.50	90920EGS	90920TGS	\$261.50
	2½"	90925ES	90925TS	\$202.50	90925EGS	90925TGS	\$261.50
	3"	90930ES	90930TS	\$296.00	90930EGS	90930TGS	\$386.50
	4"	90940ES	90940TS	\$341.50	90940EGS	90940TGS	\$453.50
	5" *	79008	79008T	\$485.50	79008G	79008GT	\$645.50
	6"	90960ES	90960TS	\$593.00	90960EGS	90960TGS	\$803.50
	8"	90980ES	90980TS	\$1,045.00	90980EGS	90980TGS	\$1,398.00
	10"	90910ES	90910TS	\$1,356.00	90910EGS	90910TGS	\$1,821.00
	12" *	79009	79009T	\$1,702.00	79009G	79009GT	\$2,347.00
	14" *	79010	79010T	\$2,336.50	79010G	79010GT	\$3,032.50
16" *	79011	79011T	\$3,196.00	79011G	79011GT	\$4,079.00	
18"	90918ES	90918TS	\$4,263.50	90918EGS	90918TGS	\$5,533.00	

* Shurjoint brand model 79.

Orders for items in shaded areas **cannot** be cancelled or returned.

Technical Data Sheet: G190

Mechanical Products Section 9 – Plain End Systems

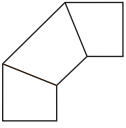

#910 Plain End 90° Elbow

	Nominal Size	Painted		Galvanized	
		Part Number	List Price	Part Number	List Price
		2"	91020F	\$590.00	91020GF
2½"	91025F	\$690.50	91025GF	\$767.00	
3"	91030F	\$717.00	91030GF	\$801.50	
4"	91040F	\$811.50	91040GF	\$893.00	
6"	91060F	\$1,178.50	91060GF	\$1,434.50	
8"	91080F	\$2,213.00	91080GF	\$2,502.00	
10"	91010F	\$2,817.00	91010GF	\$3,153.00	
12"	91012F	\$3,134.50	91012GF	\$4,823.00	

Orders for items in shaded areas **cannot** be cancelled or returned.

Technical Data Sheet: G192

#910LR Plain End Long Radius 90° Elbow

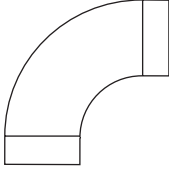
	Nominal Size	Painted		Galvanized	
		Part Number	List Price	Part Number	List Price
		2"	91020LF	POA	91020LGF
2½"	91025LF	POA	91025LGF	POA	
3"	91030LF	POA	91030LGF	POA	
4"	91040LF	POA	91040LGF	POA	
6"	91060LF	POA	91060LGF	POA	
8"	91080LF	POA	91080LGF	POA	

Orders for items in shaded areas **cannot** be cancelled or returned.

Technical Data Sheet: G192

#901 Plain End 45° Elbow

	Nominal Size	Painted		Galvanized	
		Part Number	List Price	Part Number	List Price
		2"	90120F	\$625.50	90120GF
2½"	90125F	\$625.50	90125GF	\$769.50	
3"	90130F	\$717.00	90130GF	\$807.50	
4"	90140F	\$747.00	90140GF	\$827.00	
6"	90160F	\$1,068.50	90160GF	\$1,254.00	
8"	90180F	\$1,252.50	90180GF	\$1,768.50	
10"	90110F	\$1,294.00	90110GF	\$1,616.50	
12"	90112F	\$2,338.00	90112GF	\$2,753.00	

Orders for items in shaded areas **cannot** be cancelled or returned.

Technical Data Sheet: G192

Introduction
Couplings & Fittings
Mechanical Tees
Valves
Circuit Balancing Valves
Accessories
Copper Systems
Stainless Steel Systems
Plain End Systems
Stainless Steel G-PRESS
HDPE Systems
Gaskets & Spare Parts
Preparation Equipment
Miscellaneous
Indices

#901LR Plain End Long Radius 45° Elbow

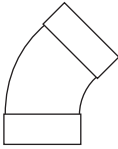
	Nominal Size	Painted		Galvanized	
		Part Number	List Price	Part Number	List Price
		2"	90120LF	POA	90120LGF
2½"	90125LF	POA	90125LGF	POA	
3"	90130LF	POA	90130LGF	POA	
4"	90140LF	POA	90140LGF	POA	
6"	90160LF	POA	90160LGF	POA	
8"	90180LF	POA	90180LGF	POA	

 Orders for items in shaded areas *cannot* be cancelled or returned.

Technical Data Sheet: G192
#919 Plain End Tee

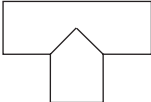
	Nominal Size	Painted		Galvanized	
		Part Number	List Price	Part Number	List Price
		2"	91920F	\$482.00	91920GF
2½"	91925F	\$628.50	91925GF	\$711.00	
3"	91930F	\$964.50	91930GF	\$1,101.00	
4"	91940F	\$1,381.00	91940GF	\$1,726.00	
6"	91960F	\$1,643.00	91960GF	\$1,886.00	
8"	91980F	\$2,368.00	91980GF	POA	
10"	91910F	POA	91910GF	POA	
12"	91912F	\$4,339.00	91912GF	POA	

 Orders for items in shaded areas *cannot* be cancelled or returned.

Technical Data Sheet: G192
#927 Plain End Cross

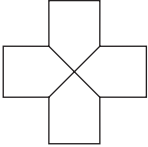
	Nominal Size	Painted		Galvanized	
		Part Number	List Price	Part Number	List Price
		2"	92720F	\$652.50	92720GF
2½"	92725F	POA	92725GF	POA	
3"	92730F	POA	92730GF	POA	
4"	92740F	POA	92740GF	POA	
6"	92760F	POA	92760GF	POA	
8"	92780F	POA	92780GF	POA	
10"	92710F	POA	92710GF	POA	
12"	92712F	POA	92712GF	POA	

 Orders for items in shaded areas *cannot* be cancelled or returned.

Technical Data Sheet: G192

Mechanical Products Section 9 – Plain End Systems

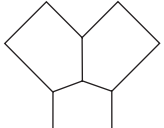

#924 Plain End True Wye

	Nominal Size	Painted		Galvanized	
		Part Number	List Price	Part Number	List Price
		2"	92420F	POA	92420GF
2½"	92425F	POA	92425GF	POA	
3"	92430F	POA	92430GF	POA	
4"	92440F	POA	92440GF	POA	
6"	92460F	POA	92460GF	POA	
8"	92480F	POA	92480GF	POA	
10"	92410F	POA	92410GF	POA	
12"	92412F	POA	92412GF	POA	

Orders for items in shaded areas **cannot** be cancelled or returned.

Technical Data Sheet: G192

#960 Plain End Cap (Bull Plug)

	Nominal Size	Painted		Galvanized	
		Part Number	List Price	Part Number	List Price
		2"	96020F	\$337.50	96020GF
2½"	96025F	\$337.50	96025GF	POA	
3"	96030F	\$492.50	96030GF	POA	
4"	96040F	\$634.50	96040GF	POA	
6"	96060F	\$1,487.50	96060GF	POA	
8"	96080F	\$2,793.00	96080GF	POA	
10"	96010F	POA	96010GF	POA	
12"	96012F	\$7,495.50	96012GF	POA	

Orders for items in shaded areas **cannot** be cancelled or returned.

Technical Data Sheet: G192

#914 Plain End Lateral

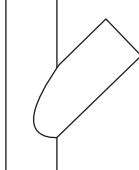
	Nominal Size	Painted		Galvanized	
		Part Number	List Price	Part Number	List Price
		2"	91420F	\$650.50	91420GF
2½"	91425F	\$748.00	91425GF	\$880.00	
3"	91430F	\$888.00	91430GF	\$1,044.00	
4"	91440F	\$1,223.00	91440GF	\$1,369.00	
6"	91460F	\$2,139.50	91460GF	\$2,595.50	
8"	91480F	\$3,589.00	91480GF	\$4,225.50	
10"	91410F	\$3,588.50	91410GF	\$6,276.00	
12"	91412F	\$6,596.00	91412GF	\$8,482.50	

Orders for items in shaded areas **cannot** be cancelled or returned.

Technical Data Sheet: G192

Introduction
 Couplings & Fittings
 Mechanical Tees
 Valves
 Circuit Balancing Valves
 Accessories
 Copper Systems
 Stainless Steel Systems
 Plain End Systems
 Stainless Steel G-PRESS
 HDPE Systems
 Gaskets & Spare Parts
 Preparation Equipment
 Miscellaneous
 Indices

#999 Plain End Swaged Nipple

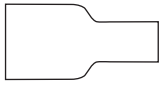
	Nominal Size	Painted		Galvanized	
		Part Number	List Price	Part Number	List Price
	2 1/2" x 2"	9992520F	POA	9992520GF	POA
	3" x 2"	9993020F	POA	9993020GF	POA
	3" x 2 1/2"	9993025F	POA	9993025GF	POA
	4" x 2"	9994020F	POA	9994020GF	POA
	4" x 2 1/2"	9994025F	POA	9994025GF	POA
	4" x 3"	9994030F	POA	9994030GF	POA
	5" x 2"	9995020F	POA	9995020GF	POA
	5" x 3"	9995030F	POA	9995030GF	POA
	5" x 4"	9995040F	POA	9995040GF	POA
	6" x 2"	9996020F	POA	9996020GF	POA
	6" x 2 1/2"	9996025F	POA	9996025GF	POA
	6" x 3"	9996030F	POA	9996030GF	POA
	6" x 4"	9996040F	POA	9996040GF	POA
	6" x 5"	9996050F	POA	9996050GF	POA
	8" x 3"	9998030F	POA	9998030GF	POA
	8" x 4"	9998040F	POA	9998040GF	POA
8" x 5"	9998050F	POA	9998050GF	POA	
8" x 6"	9998060F	POA	9998060GF	POA	

Orders for items in shaded areas *cannot* be cancelled or returned.

Technical Data Sheet: G192

#991 Adapter Nipple – Plain x Thread

	Nominal Size	Painted		Galvanized	
		Part Number	List Price	Part Number	List Price
	2"	99120F	\$58.00	99120GF	POA
	2 1/2"	99125F	\$67.00	99125GF	POA
	3"	99130F	\$81.50	99130GF	POA
	4"	99140F	\$132.50	99140GF	POA
	6"	99160F	\$350.50	99160GF	POA
	8"	99180F	POA	99180GF	POA

Orders for items in shaded areas *cannot* be cancelled or returned.

Technical Data Sheet: G192

Mechanical Products Section 9 – Plain End Systems



#992 Adapter Nipple – Plain x Grooved					
	Nominal Size	Painted		Galvanized	
		Part Number	List Price	Part Number	List Price
		2"	99220F	\$58.00	99220GF
	2½"	99225F	\$67.00	99225GF	POA
	3"	99230F	\$81.50	99230GF	POA
	4"	99240F	\$132.50	99240GF	POA
	6"	99260F	\$350.50	99260GF	POA
	8"	99280F	POA	99280GF	POA
Orders for items in shaded areas <i>cannot</i> be cancelled or returned.					
Technical Data Sheet: G192					

#993 Adapter Nipple – Plain x Bevel					
	Nominal Size	Painted		Galvanized	
		Part Number	List Price	Part Number	List Price
		2"	99320F	\$58.00	99320GF
	2½"	99325F	\$67.00	99325GF	POA
	3"	99330F	\$81.50	99330GF	POA
	4"	99340F	\$132.50	99340GF	POA
	6"	99360F	\$350.50	99360GF	POA
	8"	99380F	POA	99380GF	POA
Orders for items in shaded areas <i>cannot</i> be cancelled or returned.					
Technical Data Sheet: G192					

#941 Flange Adapter 150 lbs.					
	Nominal Size	Painted		Galvanized	
		Part Number	List Price	Part Number	List Price
		2"	94120F	POA	94120GF
	2½"	94125F	POA	94125GF	POA
	3"	94130F	POA	94130GF	POA
	4"	94140F	POA	94140GF	POA
	6"	94160F	POA	94160GF	POA
	8"	94180F	POA	94180GF	POA
Orders for items in shaded areas <i>cannot</i> be cancelled or returned.					
Raised face flanges are standard; flat flanges are quoted on application.					
Technical Data Sheet: G192					

Introduction
Couplings & Fittings
Mechanical Tees
Valves
Circuit Balancing Valves
Accessories
Copper Systems
Stainless Steel Systems
Plain End Systems
Stainless Steel G-PRESS
HDPE Systems
Gaskets & Spare Parts
Preparation Equipment
Miscellaneous
Indices

#942 Flange Adapter 300 lbs.

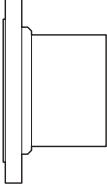
	Nominal Size	Painted		Galvanized	
		Part Number	List Price	Part Number	List Price
	2"	94220F	POA	94220GF	POA
	2½"	94225F	POA	94225GF	POA
	3"	94230F	POA	94230GF	POA
	4"	94240F	POA	94240GF	POA
	6"	94260F	POA	94260GF	POA
	8"	94280F	POA	94280GF	POA

 Orders for items in shaded areas **cannot** be cancelled or returned.

Raised face flanges are standard; flat flanges are quoted on application.

Technical Data Sheet: G192
#921 Reducing Tee Plain End

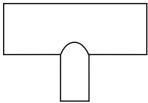
	Nominal Size	Painted		Galvanized	
		Part Number	List Price	Part Number	List Price
	3" x 3" x 2"	9213020F	POA	9213020GF	\$959.00
	4" x 4" x 2"	9214020F	\$597.00	9214020GF	POA
	4" x 4" x 2½"	9214025F	\$614.00	9214025GF	POA
	4" x 4" x 3"	9214030F	\$614.00	9214030GF	POA
	6" x 6" x 2"	9216020F	POA	9216020GF	POA
	6" x 6" x 3"	9216030F	\$1,045.00	9216030GF	POA
	6" x 6" x 4"	9216040F	POA	9216040GF	\$1,344.50
	8" x 8" x 2"	9218020F	POA	9218020GF	\$3,648.00
	8" x 8" x 3"	9218030F	POA	9218030GF	POA
	8" x 8" x 4"	9218040F	\$1,187.00	9218040GF	POA
	8" x 8" x 6"	9218060F	\$1,391.50	9218060GF	POA
	10" x 10" x 4"	9211040F	POA	9211040GF	POA
	10" x 10" x 6"	9211060F	POA	9211060GF	POA
	10" x 10" x 8"	9211080F	POA	9211080GF	POA

 Orders for items in shaded areas **cannot** be cancelled or returned.

Technical Data Sheet: G192

Mechanical Products Section 10 – SS G-PRESS Systems



#407 G-PRESS 316 Stainless Steel Coupling (Press x Press)

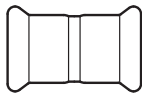

Nominal Size	Grade "E" EPDM O-Ring Part Number	Grade "T" Nitrile O-Ring Part Number	List Price	Grade "O" Fluoroelastomer O-Ring Part Number	List Price	Pieces/ Bag Quantities
1/2"	407050E	407050T	\$54.50	4070500	\$74.00	20
3/4"	407075E	407075T	\$60.00	4070750	\$83.00	20
1"	407100E	407100T	\$68.00	4071000	\$89.50	10
1 1/2"	407150E	407150T	\$91.00	4071500	\$154.00	4
2"	407200E	407200T	\$119.50	4072000	\$202.00	4

Orders for items in shaded areas **cannot** be cancelled or returned.

Technical Data Sheet: G550

#408 G-PRESS 316 Stainless Steel Slip Coupling (Press x Press)



Nominal Size	Grade "E" EPDM O-Ring Part Number	Grade "T" Nitrile O-Ring Part Number	List Price	Grade "O" Fluoroelastomer O-Ring Part Number	List Price	Pieces/ Bag Quantities
1/2"	408050E	408050T	\$71.50	4080500	\$91.00	20
3/4"	408075E	408075T	\$77.50	4080750	\$101.00	20
1"	408100E	408100T	\$89.00	4081000	\$118.50	10
1 1/2"	408150E	408150T	\$114.00	4081500	\$201.00	4
2"	408200E	408200T	\$146.00	4082000	\$257.00	4

Orders for items in shaded areas **cannot** be cancelled or returned.

Technical Data Sheet: G550

#468 G-PRESS 316 Stainless Steel 90° Elbow (Press x Press)

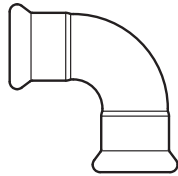

Nominal Size	Grade "E" EPDM O-Ring Part Number	Grade "T" Nitrile O-Ring Part Number	List Price	Grade "O" Fluoroelastomer O-Ring Part Number	List Price	Pieces/ Bag Quantities
1/2"	468050E	468050T	\$101.50	4680500	\$121.00	20
3/4"	468075E	468075T	\$114.00	4680750	\$138.00	10
1"	468100E	468100T	\$135.50	4681000	\$165.00	10
1 1/2"	468150E	468150T	\$267.50	4681500	\$354.00	2
2"	468200E	468200T	\$341.50	4682000	\$453.00	2

Orders for items in shaded areas **cannot** be cancelled or returned.

Technical Data Sheet: G550

Introduction
Couplings & Fittings
Mechanical Tees
Valves
Circuit Balancing Valves
Accessories
Copper Systems
Stainless Steel Systems
Plain End Systems
Stainless Steel G-PRESS
HDPE Systems
Gaskets & Spare Parts
Preparation Equipment
Miscellaneous
Indices

#467 G-PRESS 316 Stainless Steel 90° Elbow (Press x Fitting)

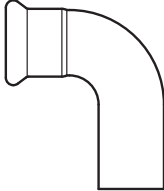
	Nominal Size	Grade "E" EPDM O-Ring Part Number	Grade "T" Nitrile O-Ring Part Number	List Price	Grade "O" Fluoroelastomer O-Ring Part Number	List Price	Pieces/ Bag Quantities
	1/2"	467050E	467050T	\$101.50	4670500	\$111.00	20
	3/4"	467075E	467075T	\$114.00	4670750	\$126.50	10
	1"	467100E	467100T	\$135.50	4671000	\$149.50	10
	1 1/2"	467150E	467150T	\$267.50	4671500	\$311.00	2
	2"	467200E	467200T	\$341.50	4672000	\$396.50	2

 Orders for items in shaded areas *cannot* be cancelled or returned.

Technical Data Sheet: G550
#471 G-PRESS 316 Stainless Steel 45° Elbow (Press x Press)

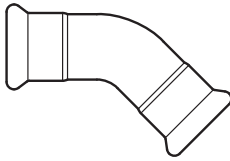
	Nominal Size	Grade "E" EPDM O-Ring Part Number	Grade "T" Nitrile O-Ring Part Number	List Price	Grade "O" Fluoroelastomer O-Ring Part Number	List Price	Pieces/ Bag Quantities
	1/2"	471050E	471050T	\$90.50	4710500	\$110.00	10
	3/4"	471075E	471075T	\$100.00	4710750	\$123.00	10
	1"	471100E	471100T	\$119.00	4711000	\$148.00	10
	1 1/2"	471150E	471150T	\$233.00	4711500	\$319.50	2
	2"	471200E	471200T	\$298.00	4712000	\$409.50	2

 Orders for items in shaded areas *cannot* be cancelled or returned.

Technical Data Sheet: G550
#470 G-PRESS 316 Stainless Steel 45° Elbow (Press x Fitting)

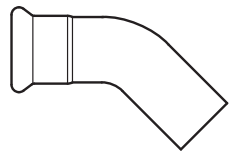
	Nominal Size	Grade "E" EPDM O-Ring Part Number	Grade "T" Nitrile O-Ring Part Number	List Price	Grade "O" Fluoroelastomer O-Ring Part Number	List Price	Pieces/ Bag Quantities
	1/2"	470050E	470050T	\$90.50	4700500	\$100.50	20
	3/4"	470075E	470075T	\$100.00	4700750	\$111.00	10
	1"	470100E	470100T	\$119.00	4701000	\$133.50	10
	1 1/2"	470150E	470150T	\$233.00	4701500	\$276.00	2
	2"	470200E	470200T	\$298.00	4702000	\$354.00	2

 Orders for items in shaded areas *cannot* be cancelled or returned.

Technical Data Sheet: G550

Mechanical Products

Section 10 – SS G-PRESS Systems

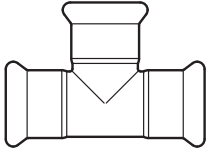

#442 G-PRESS 316 Stainless Steel Equal Tee (Press x Press x Press)

	Nominal Size	Grade "E" EPDM O-Ring Part Number	Grade "T" Nitrile O-Ring Part Number	List Price	Grade "O" Fluoroelastomer O-Ring Part Number	List Price	Pieces/ Bag Quantities
	1/2"	442050E	442050T	\$184.00	442050O	\$214.00	20
	3/4"	442075E	442075T	\$203.00	442075O	\$238.50	10
	1"	442100E	442100T	\$217.50	442100O	\$261.50	10
	1 1/2"	442150E	442150T	\$278.00	442150O	\$407.50	2
	2"	442200E	442200T	\$346.00	442200O	\$512.00	2

Orders for items in shaded areas *cannot* be cancelled or returned.

Technical Data Sheet: G550

#473 G-PRESS 316 Stainless Steel Reducing Tee (Press x Press x Press)

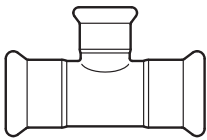
	Nominal Size	Grade "E" EPDM O-Ring Part Number	Grade "T" Nitrile O-Ring Part Number	List Price	Grade "O" Fluoroelastomer O-Ring Part Number	List Price	Pieces/ Bag Quantities
	3/4" x 3/4" x 1/2"	4737505E	4737505T	\$205.00	4737505O	\$238.50	10
	1" x 1" x 1/2"	4731005E	4731005T	\$211.50	4731005O	\$251.00	10
	1" x 1" x 3/4"	4731075E	4731075T	\$216.50	4731075O	\$258.00	10
	1 1/2" x 1 1/2" x 1/2"	4731505E	4731505T	\$255.00	4731505O	\$351.00	2
	1 1/2" x 1 1/2" x 3/4"	4731575E	4731575T	\$258.00	4731575O	\$355.50	2
	1 1/2" x 1 1/2" x 1"	4731510E	4731510T	\$259.00	4731510O	\$359.50	2
	2" x 2" x 1/2"	4732005E	4732005T	\$332.00	4732005O	\$453.00	2
	2" x 2" x 3/4"	4732075E	4732075T	\$337.00	4732075O	\$460.00	2
	2" x 2" x 1"	4732010E	4732010T	\$346.50	4732010O	\$473.00	2
2" x 2" x 1 1/2"	4732015E	4732015T	\$382.00	4732015O	\$536.00	2	

Orders for items in shaded areas *cannot* be cancelled or returned.

Technical Data Sheet: G550

Introduction
Couplings & Fittings
Mechanical Tees
Valves
Circuit Balancing Valves
Accessories
Copper Systems
Stainless Steel Systems
Plain End Systems
Stainless Steel G-PRESS
HDPE Systems
Gaskets & Spare Parts
Preparation Equipment
Miscellaneous
Indices

#478 G-PRESS 316 Stainless Steel Reducing Tee Adapter (Press x Press x Female NPT)

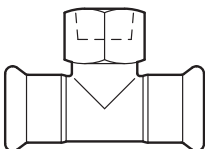
	<i>Nominal Size</i>	<i>Grade "E" EPDM O-Ring Part Number</i>	<i>Grade "T" Nitrile O-Ring Part Number</i>	<i>List Price</i>	<i>Grade "O" Fluoroelastomer O-Ring Part Number</i>	<i>List Price</i>	<i>Pieces/Bag Quantities</i>
	$\frac{1}{2}'' \times \frac{1}{2}'' \times \frac{1}{2}''$	4780505E	4780505T	\$278.00	4780505O	\$297.50	20
$\frac{1}{2}'' \times \frac{1}{2}'' \times \frac{3}{4}''$	4780575E	4780575T	\$334.00	4780575O	\$355.00	20	
$\frac{3}{4}'' \times \frac{3}{4}'' \times \frac{1}{2}''$	4787505E	4787505T	\$301.00	4787505O	\$324.00	10	
$\frac{3}{4}'' \times \frac{3}{4}'' \times \frac{3}{4}''$	4787575E	4787575T	\$304.00	4787575O	\$327.50	10	
$\frac{3}{4}'' \times \frac{3}{4}'' \times 1''$	4787510E	4787510T	\$360.00	4787510O	\$385.50	10	
$1'' \times 1'' \times \frac{1}{2}''$	4781015E	4781015T	\$306.00	4781015O	\$335.50	10	
$1'' \times 1'' \times \frac{3}{4}''$	4781075E	4781075T	\$307.00	4781075O	\$337.00	10	
$1'' \times 1'' \times 1''$	4781010E	4781010T	\$333.50	4781010O	\$363.00	–	
$1'' \times 1'' \times 1\frac{1}{4}''$	4781012E	4781012T	\$360.00	4781012O	\$394.00	10	
$1\frac{1}{2}'' \times 1\frac{1}{2}'' \times \frac{1}{2}''$	4781505E	4781505T	\$346.50	4781505O	\$433.50	4	
$1\frac{1}{2}'' \times 1\frac{1}{2}'' \times \frac{3}{4}''$	4781575E	4781575T	\$350.50	4781575O	\$436.50	4	
$1\frac{1}{2}'' \times 1\frac{1}{2}'' \times 1''$	4781510E	4781510T	\$382.50	4781510O	\$469.50	4	
$1\frac{1}{2}'' \times 1\frac{1}{2}'' \times 1\frac{1}{2}''$	4781515E	4781515T	\$412.00	4781515O	\$466.50	4	
$2'' \times 2'' \times \frac{1}{2}''$	4782005E	4782005T	\$395.00	4782005O	\$506.00	2	
$2'' \times 2'' \times \frac{3}{4}''$	4782075E	4782075T	\$399.00	4782075O	\$510.50	2	
$2'' \times 2'' \times 1''$	4782010E	4782010T	\$427.50	4782010O	\$538.50	2	
$2'' \times 2'' \times 2''$	4782020E	4782020T	\$571.50	4782020O	\$664.50	2	

Orders for items in shaded areas *cannot* be cancelled or returned.

Technical Data Sheet: G550

#474 G-PRESS 316 Stainless Steel Reducer (Fitting x Press)

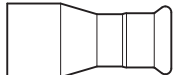
	<i>Nominal Size</i>	<i>Grade "E" EPDM O-Ring Part Number</i>	<i>Grade "T" Nitrile O-Ring Part Number</i>	<i>List Price</i>	<i>Grade "O" Fluoroelastomer O-Ring Part Number</i>	<i>List Price</i>	<i>Pieces/Bag Quantities</i>
	$\frac{3}{4}'' \times \frac{1}{2}''$	4747505E	4747505T	\$166.50	4747505O	\$188.50	10
$1'' \times \frac{1}{2}''$	4741005E	4741005T	\$224.00	4741005O	\$249.00	10	
$1'' \times \frac{3}{4}''$	4741075E	4741075T	\$178.00	4741075O	\$204.50	10	
$1\frac{1}{2}'' \times \frac{1}{2}''$	4741505E	4741505T	\$314.50	4741505O	\$367.00	4	
$1\frac{1}{2}'' \times \frac{3}{4}''$	4741575E	4741575T	\$295.00	4741575O	\$350.00	4	
$1\frac{1}{2}'' \times 1''$	4741510E	4741510T	\$164.50	4741510O	\$222.50	4	
$2'' \times \frac{1}{2}''$	4742005E	4742005T	\$583.00	4742005O	\$648.50	2	
$2'' \times \frac{3}{4}''$	4742075E	4742075T	\$263.00	4742075O	\$330.50	2	
$2'' \times 1''$	4742010E	4742010T	\$203.00	4742010O	\$273.50	2	
$2'' \times 1\frac{1}{2}''$	4742015E	4742015T	\$203.00	4742015O	\$302.00	2	

Orders for items in shaded areas *cannot* be cancelled or returned.

Technical Data Sheet: G550

Mechanical Products Section 10 – SS G-PRESS Systems

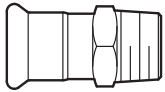

#476 G-PRESS 316 Stainless Steel Adapter (Press x Male NPT)

	Nominal Size	Grade "E" EPDM O-Ring Part Number	Grade "T" Nitrile O-Ring Part Number	List Price	Grade "O" Fluoroelastomer O-Ring Part Number	List Price	Pieces/Bag Quantities
	1/2" x 1/2"	4760505E	4760505T	\$102.00	4760505O	\$112.00	20
1/2" x 3/4"	4760575E	4760575T	\$141.00	4760575O	\$153.50	20	
1/2" x 1"	4760510E	4760510T	\$156.00	4760510O	\$169.00	20	
3/4" x 1/2"	4767505E	4767505T	\$106.00	4767505O	\$116.50	–	
3/4" x 3/4"	4767575E	4767575T	\$106.00	4767575O	\$118.50	20	
3/4" x 1"	4767510E	4767510T	\$123.00	4767510O	\$138.00	20	
3/4" x 1 1/4"	4767512E	4767512T	\$156.00	4767512O	\$167.50	20	
1" x 3/4"	4761075E	4761075T	\$126.00	4761075O	\$138.00	–	
1" x 1"	4761010E	4761010T	\$126.00	4761010O	\$140.50	10	
1" x 1 1/4"	4761012E	4761012T	\$156.00	4761012O	\$172.50	10	
1" x 1 1/2"	4761015E	4761015T	\$156.00	4761015O	\$172.50	10	
1 1/2" x 3/4"	4761575E	4761575T	\$234.00	4761575O	\$246.00	–	
1 1/2" x 1"	4761510E	4761510T	POA	4761510O	POA	–	
1 1/2" x 1 1/4"	4761512E	4761512T	\$239.50	4761512O	\$264.00	4	
1 1/2" x 1 1/2"	4761515E	4761515T	\$209.50	4761515O	\$278.50	4	
2" x 1 1/2"	4762015E	4762015T	\$348.00	4762015O	\$389.00	4	
2" x 2"	4762020E	4762020T	\$258.50	4762020O	\$315.50	4	

Orders for items in shaded areas **cannot** be cancelled or returned.

Technical Data Sheet: G550

#479 G-PRESS 316 Stainless Steel (Press x Female NPT)

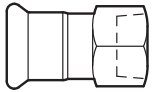
	Nominal Size	Grade "E" EPDM O-Ring Part Number	Grade "T" Nitrile O-Ring Part Number	List Price	Grade "O" Fluoroelastomer O-Ring Part Number	List Price	Pieces/Bag Quantities
	1/2" x 1/2"	4790505E	4790505T	\$124.50	4790505O	\$134.00	20
1/2" x 3/4"	4790575E	4790575T	\$178.50	4790575O	\$193.50	20	
1/2" x 1"	4790510E	4790510T	\$240.50	4790510O	\$285.00	20	
3/4" x 1/2"	4797505E	4797505T	\$125.00	4797505O	\$137.00	–	
3/4" x 3/4"	4797575E	4797575T	\$127.50	4797575O	\$139.50	20	
3/4" x 1"	4797510E	4797510T	\$127.50	4797510O	\$138.00	20	
3/4" x 1 1/4"	4797512E	4797512T	\$371.00	4797512O	\$403.50	20	
1" x 1/2"	4791005E	4791005T	\$134.50	4791005O	\$149.50	–	
1" x 3/4"	4791075E	4791075T	\$143.50	4791075O	\$158.00	–	
1" x 1"	4791010E	4791010T	\$152.50	4791010O	\$167.50	10	
1" x 1 1/4"	4791012E	4791012T	\$287.50	4791012O	\$312.50	10	
1" x 1 1/2"	4791015E	4791015T	\$287.50	4791015O	\$312.50	10	
1 1/2" x 1"	4791510E	4791510T	\$240.50	4791510O	\$285.00	–	
1 1/2" x 1 1/4"	4791512E	4791512T	POA	4791512O	POA	–	
1 1/2" x 1 1/2"	4791515E	4791515T	\$302.00	4791515O	\$346.00	4	
1 1/2" x 2"	4791520E	4791520T	\$356.50	4791520O	\$391.50	4	
2" x 1 1/4"	4792012E	4792012T	\$352.50	4792012O	POA	–	
2" x 1 1/2"	4792015E	4792015T	\$297.50	4792015O	\$355.00	4	
2" x 2"	4792020E	4792020T	\$327.50	4792020O	\$385.00	4	

Orders for items in shaded areas **cannot** be cancelled or returned.

Technical Data Sheet: G550

#484 G-PRESS 316 Stainless Steel End Cap (Press)

	Nominal Size	Grade "E" EPDM O-Ring Part Number	Grade "T" Nitrile O-Ring Part Number	List Price	Grade "O" Fluoroelastomer O-Ring Part Number	List Price	Pieces/Bag Quantities
	1/2"	484050E	484050T	\$127.00	484050O	\$136.50	10
3/4"	484075E	484075T	\$140.50	484075O	\$150.00	10	
1"	484100E	484100T	\$149.50	484100O	\$166.50	10	
1 1/2"	484150E	484150T	\$191.50	484150O	\$281.50	4	
2"	484200E	484200T	\$238.50	484200O	\$327.00	4	

 Orders for items in shaded areas *cannot* be cancelled or returned.

Technical Data Sheet: G550
#461 G-PRESS 316 Stainless Steel Weld Adaptor (Fitting x Weld)

	Nominal Size	Grade "E" EPDM O-Ring Part Number	Grade "T" Nitrile O-Ring Part Number	List Price	Grade "O" Fluoroelastomer O-Ring Part Number	List Price	Pieces/Bag Quantities
	1/2"	461050E	461050T	\$99.50	461050O	\$108.50	–
3/4"	461075E	461075T	\$102.50	461075O	\$113.50	–	
1"	461100E	461100T	\$121.50	461100O	\$135.50	–	
1 1/2"	461150E	461150T	\$211.50	461150O	\$252.50	–	
2"	461200E	461200T	\$250.00	461200O	\$302.50	–	

 Orders for items in shaded areas *cannot* be cancelled or returned.

Technical Data Sheet: G550
#477 G-PRESS 316 Stainless Steel Transition Nipple (Groove x Fitting)

	Nominal Size	Part Number	List Price	Pieces/Bag Quantities
	3/4"	477075	\$138.50	–
1"	477100	\$143.00	–	
1 1/2"	477150	\$179.00	–	
2"	477200	\$187.50	–	

Technical Data Sheet: G550
#485 G-PRESS 316 Stainless Steel Union (Press x Press)

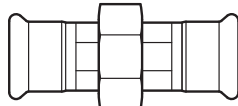
	Nominal Size	Grade "E" EPDM O-Ring Part Number	Grade "T" Nitrile O-Ring Part Number	List Price	Grade "O" Fluoroelastomer O-Ring Part Number	List Price	Pieces/Bag Quantities
	1/2"	485050E	485050T	\$615.50	485050O	\$636.00	10
3/4"	485075E	485075T	\$699.00	485075O	\$722.50	10	
1"	485100E	485100T	\$850.50	485100O	\$879.50	4	
1 1/2"	485150E	485150T	\$1,453.50	485150O	\$1,539.50	2	
2"	485200E	485200T	\$1,791.50	485200O	\$1,903.00	2	

 Orders for items in shaded areas *cannot* be cancelled or returned.

Technical Data Sheet: G550

Mechanical Products Section 10 – SS G-PRESS Systems

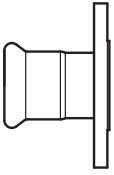

#475 G-PRESS 316 Stainless Steel Flange Adapter (Press x Flange)

	Nominal Size	Grade "E" EPDM O-Ring Part Number	Grade "T" Nitrile O-Ring Part Number	List Price	Grade "O" Fluoroelastomer O-Ring Part Number	List Price	Pieces/Bag Quantities
	1/2"	475050E	475050T	\$749.00	4750500	\$759.50	1
	3/4"	475075E	475075T	\$771.50	4750750	\$783.00	1
	1"	475100E	475100T	\$783.00	4751000	\$798.50	1
	1 1/2"	475150E	475150T	\$954.00	4751500	\$997.50	1
	2"	475200E	475200T	\$1,062.50	4752000	\$1,117.50	1

Orders for items in shaded areas *cannot* be cancelled or returned.

Technical Data Sheet: G550

#466 G-PRESS 316 Stainless Steel Flange Adapter Van Stone (Press x Flange)

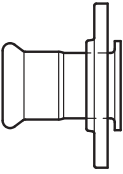
	Nominal Size	Grade "E" EPDM O-Ring Part Number	Grade "T" Nitrile O-Ring Part Number	List Price	Grade "O" Fluoroelastomer O-Ring Part Number	List Price	Pieces/Bag Quantities
	1/2"	466050E	466050T	\$262.00	4660500	\$272.50	1
	3/4"	466075E	466075T	\$262.00	4660750	\$274.50	1
	1"	466100E	466100T	\$353.00	4661000	\$368.00	1
	1 1/2"	466150E	466150T	\$388.50	4661500	\$432.00	1
	2"	466200E	466200T	\$417.00	4662000	\$472.50	1

Orders for items in shaded areas *cannot* be cancelled or returned.

Technical Data Sheet: G550

#469 G-PRESS Stainless Steel Ball Valve (Press x Press)

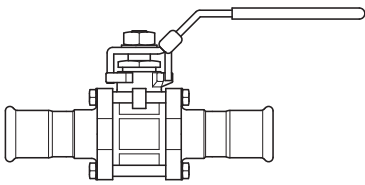
	Nominal Size	Grade "E" EPDM O-Ring Part Number	Grade "T" Nitrile O-Ring Part Number	List Price	Grade "O" Fluoroelastomer O-Ring Part Number	List Price	Pieces/ Bag Quantities
	1/2"	469050E	469050T	\$321.00	4690500	\$340.50	1
	3/4"	469075E	469075T	\$353.00	4690750	\$376.50	1
	1"	469100E	469100T	\$422.50	4691000	\$452.50	1
	1 1/2"	469150E	469150T	\$592.50	4691500	\$678.50	1
	2"	469200E	469200T	\$725.00	4692000	\$835.50	1

Orders for items in shaded areas *cannot* be cancelled or returned.

Technical Data Sheet: G551

G-PRESS Stainless Steel O-Rings

	Nominal Size	Grade "E" EPDM O-Ring Part Number	Grade "T" Nitrile O-Ring Part Number	List Price	Grade "O" Fluoroelastomer O-Ring Part Number	List Price	Pieces/Bag Quantities
	1/2"	05SSPRESSE	05SSPRESST	\$8.50	05SSPRESSO	\$25.50	–
	3/4"	08SSPRESSE	08SSPRESST	\$9.50	08SSPRESSO	\$28.00	–
	1"	10SSPRESSE	10SSPRESST	\$11.50	10SSPRESSO	\$32.50	–
	1 1/2"	15SSPRESSE	15SSPRESST	\$14.50	15SSPRESSO	\$65.00	–
	2"	20SSPRESSE	20SSPRESST	\$20.50	20SSPRESSO	\$85.50	–

Orders for items in shaded areas *cannot* be cancelled or returned.

Technical Data Sheet: G550

**#9094 HDPE Flange Coupling
 with Grade “E” EPDM Gasket**

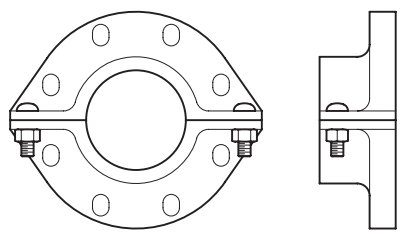
	<i>Nominal Size</i>	<i>Part Number</i>	<i>List Price</i>
	4"	909440ES	\$736.00
	6"	909460ES	\$1,035.00
	8"	909480ES	\$1,211.50
Orders for items in shaded areas <i>cannot</i> be cancelled or returned.			
Technical Data Sheet: G584			

**#9095 HDPE Coupling
 with Grade “E” EPDM Gasket**

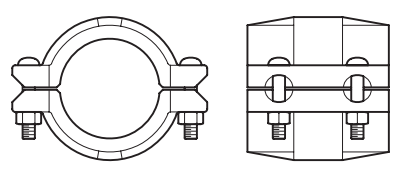
	<i>Nominal Size</i>	<i>Part Number</i>	<i>List Price</i>
	2"	909520ES	\$482.00
	3"	909530ES	\$574.50
	4"	909540ES	\$631.00
	6"	909560ES	\$877.00
	8"	909580ES	\$1,027.50
	10"	909510ES	\$1,181.50
	12"	909512ES	\$1,361.00
	14"	909514ES	\$3,845.00
	16"	909516ES	\$5,130.00
	18"	909518ES	\$6,286.00
	20"	909521ES	\$8,535.50
Orders for items in shaded areas <i>cannot</i> be cancelled or returned.			
Technical Data Sheet: G580			

Mechanical Products

Section 11 – HDPE Systems



#9097 HDPE Transition Coupling

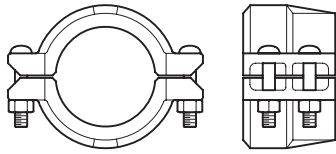



<i>Nominal Size</i>	<i>Part Number</i>	<i>List Price</i>
2"	909720ES	\$519.00
3"	909730ES	\$607.00
4"	909740ES	\$709.00
6"	909760ES	\$973.50
8"	909780ES	\$1,120.00
10"	909710ES	\$1,544.50
12"	909712ES	\$1,766.00

Orders for items in shaded areas **cannot** be cancelled or returned.

Technical Data Sheet: G582

Introduction
Couplings & Fittings
Mechanical Tees
Valves
Circuit Balancing Valves
Accessories
Copper Systems
Stainless Steel Systems
Plain End Systems
Stainless Steel G-PRESS
HDPE Systems
Gaskets & Spare Parts
Preparation Equipment
Miscellaneous
Indices

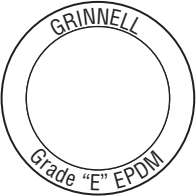
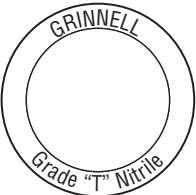

Replacement Gaskets – EPDM “E” Gaskets, Nitrile “T” Gaskets For #772, #770, #705, #707

 GRINNELL Grade “E” EPDM	 GRINNELL Grade “T” Nitrile	 Standard Gasket	<i>Nominal Size</i>	<i>Part No. “E” EPDM</i>	<i>List Price</i>	<i>Part No. “T” Nitrile</i>	<i>List Price</i>
			1"	01EPDME	\$39.50	01NITRILS	\$39.50
1¼"	13EPDME	\$42.00	13NITRILS	\$39.50			
1½"	15EPDME	\$44.00	15NITRILS	\$44.00			
2"	20EPDME	\$42.50	20NITRILS	\$42.50			
2½"	25EPDME	\$52.00	25NITRILS	\$52.00			
3"	30EPDME	\$55.50	30NITRILS	\$54.50			
4"	40EPDME	\$69.50	40NITRILS	\$67.50			
5"	50EPDME	\$89.50	50NITRILS	\$86.00			
6"	60EPDME	\$96.00	60NITRILS	\$92.00			
8"	80EPDME	\$131.00	80NITRILS	\$131.00			
10"	10EPDME	\$164.00	10NITRILS	\$164.00			
12"	12EPDME	\$191.00	12NITRILS	\$191.00			
14"	14EPDME	\$290.00	14NITRILS	\$290.00			
16"	16EPDME	\$400.00	16NITRILS	\$400.00			
18"	18EPDME	\$480.50	18NITRILS	\$480.50			
20"	21EPDME	\$737.50	21NITRILS	\$737.50			
24"	24EPDME	\$1,020.50	24NITRILS	\$1,020.50			

Orders for items in shaded areas *cannot* be cancelled or returned.

Technical Data Sheet: G610

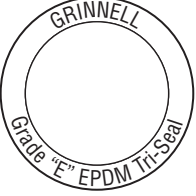
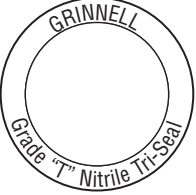
Replacement Tri-Seal Gaskets – EPDM “E” Gaskets, Nitrile “T” Gaskets For #772, #770, #705, #707

 GRINNELL Grade “E” EPDM Tri-Seal	 GRINNELL Grade “T” Nitrile Tri-Seal	 Tri-Seal Gasket	<i>Nominal Size</i>	<i>Part No. “E” EPDM</i>	<i>List Price</i>	<i>Part No. “T” Nitrile</i>	<i>List Price</i>
			1¼"	13EPDME3	\$77.50	13NITRILS3	\$77.50
1½"	15EPDME3	\$78.50	15NITRILS3	\$78.50			
2"	20EPDME3	\$81.00	20NITRILS3	\$81.00			
2½"	25EPDME3	\$98.00	25NITRILS3	\$93.50			
3"	30EPDME3	\$98.00	30NITRILS3	\$93.50			
4"	40EPDME3	\$131.00	40NITRILS3	\$131.00			
5"	50EPDME3	\$230.50	50NITRILS3	\$230.50			
6"	60EPDME3	\$236.00	60NITRILS3	\$224.50			
8"	80EPDME3	\$243.50	80NITRILS3	\$243.50			
10"	10EPDME3	\$314.00	10NITRILS3	\$314.00			
12"	12EPDME3	\$373.50	12NITRILS3	\$373.50			
14"	14EPDME3	\$431.50	14NITRILS3	\$431.50			
16"	16EPDME3	\$595.50	16NITRILS3	\$595.50			
18"	18EPDME3	\$717.50	18NITRILS3	\$717.50			
20"	21EPDME3	\$1,101.00	21NITRILS3	\$1,101.00			
24"	24EPDME3	\$1,518.00	24NITRILS3	\$1,518.00			

Orders for items in shaded areas *cannot* be cancelled or returned.

Technical Data Sheet: G610

Replacement Gaskets
Grade "L" Silicone Gasket
For #772, #770, #705, #707

	<i>Nominal Size</i>	<i>Part Number</i>	<i>List Price</i>
	1 1/4"	13SILICONE	\$195.50
	1 1/2"	15SILICONE	\$204.50
	2"	20SILICONE	\$126.50
	2 1/2"	25SILICONE	\$146.50
	3"	30SILICONE	\$158.00
	4"	40SILICONE	\$229.50
	5"	50SILICONE	\$449.00
	6"	60SILICONE	\$492.50
	8"	80SILICONE	\$550.00
	10"	10SILICONE	\$714.00
	12"	12SILICONE	\$843.00
	14"	14SILICONE	\$1,292.00
	16"	16SILICONE	\$1,649.50

Orders for items in shaded areas **cannot** be cancelled or returned.

Technical Data Sheet: G610

Replacement Gaskets
Grade "O" Fluoroelastomer Gasket
For #772, #770, #705, #707

	<i>Nominal Size</i>	<i>Part Number</i>	<i>List Price</i>
	1 1/4"	13FLUORO	\$434.50
	1 1/2"	15FLUORO	\$458.00
	2"	20FLUORO	\$375.50
	2 1/2"	25FLUORO	\$424.00
	3"	30FLUORO	\$468.00
	4"	40FLUORO	\$766.50
	5"	50FLUORO	\$821.50
	6"	60FLUORO	\$1,006.50
	8"	80FLUORO	\$1,151.50
	10"	10FLUORO	\$1,500.00
	12"	12FLUORO	\$2,220.50
	14"	14FLUORO	POA
	16"	16FLUORO	POA
	18"	18FLUORO	POA
	20"	21FLUORO	POA
24"	24FLUORO	POA	

Orders for items in shaded areas **cannot** be cancelled or returned.

Technical Data Sheet: G610

Introduction
Couplings & Fittings
Mechanical Tees
Valves
Circuit Balancing Valves
Accessories
Copper Systems
Stainless Steel Systems
Plain End Systems
Stainless Steel G-PRESS
HDPE Systems
Gaskets & Spare Parts
Preparation Equipment
Miscellaneous
Indices

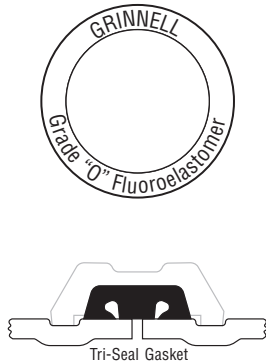
Replacement Tri-Seal Gaskets
Grade "O" Fluoroelastomer Gasket
For #772, #770, #705, #707

<i>Nominal Size</i>	<i>Part Number</i>	<i>List Price</i>
1"	01FLUOR03	\$498.00
1 ¹ / ₄ "	13FLUOR03	\$1,042.00
1 ¹ / ₂ "	15FLUOR03	\$632.50
2"	20FLUOR03	\$459.50
2 ¹ / ₂ "	25FLUOR03	POA
3"	30FLUOR03	POA
4"	40FLUOR03	POA
5"	50FLUOR03	POA
6"	60FLUOR03	\$1,271.50
8"	80FLUOR03	\$2,044.50
10"	10FLUOR03	\$2,209.00
12"	12FLUOR03	\$2,605.00
14"	14FLUOR03	POA
16"	16FLUOR03	POA
18"	18FLUOR03	POA
20"	21FLUOR03	POA
24"	24FLUOR03	POA

 Orders for items in shaded areas **cannot** be cancelled or returned.

Technical Data Sheet: G610

Replacement Gaskets
EPDM “E” Gaskets, Grade “T” Nitrile
For # 716 Reducing Coupling

 	Nominal Size	Part No. “E” EPDM	Part No. “T” Nitrile	List Price
	2" x 1½"	2015EPDME	2015NITRILS	\$42.00
	2½" x 2"	2520EPDME	2520NITRILS	\$54.00
	3" x 2"	3020EPDME	3020NITRILS	\$61.00
	3" x 2½"	3025EPDME	3025NITRILS	\$61.00
	4" x 2"	4020EPDME	4020NITRILS	\$70.50
	4" x 2½"	4025EPDME	4025NITRILS	\$71.50
	4" x 3"	4030EPDME	4030NITRILS	\$73.50
	5" x 4"	5040EPDME	5040NITRILS	\$85.50
	6" x 4"	6040EPDME	6040NITRILS	\$96.50
6" x 5"	6050EPDME	6050NITRILS	\$105.50	
8" x 6"	8060EPDME	8060NITRILS	\$117.00	

Orders for items in shaded areas **cannot** be cancelled or returned.

Technical Data Sheet: G610

Replacement Gaskets
EPDM “E” Gaskets, Grade “T” Nitrile
For #780 Snap Coupling

	Nominal Size	Grade “E” EPDM	Grade “T” Nitrile	List Price
	1"	78001EPDME	78001NITRILS	\$39.50
	1¼"	78013EPDME	78013NITRILS	\$42.00
	1½"	78015EPDME	78015NITRILS	\$44.00
	2"	78020EPDME	78020NITRILS	\$42.50
	2½"	78025EPDME	78025NITRILS	\$52.00
	3"	78030EPDME	78030NITRILS	\$55.50
	4"	78040EPDME	78040NITRILS	\$69.50
	5"	78050EPDME	78050NITRILS	\$89.50
	6"	78060EPDME	78060NITRILS	\$96.00
8"	78080EPDME	78080NITRILS	\$131.00	

Orders for items in shaded areas **cannot** be cancelled or returned.

Technical Data Sheet: G610

Introduction
 Couplings & Fittings
 Mechanical Tees
 Valves
 Circuit Balancing Valves
 Accessories
 Copper Systems
 Stainless Steel Systems
 Plain End Systems
 Stainless Steel G-PRESS
 HDPE Systems
 Gaskets & Spare Parts
 Preparation Equipment
 Miscellaneous
 Indices

#71H Hinged Flange Adapter Replacement
“E” EPDM Gasket, “T” Nitrile Gasket & “O” Fluoroelastomer Gasket

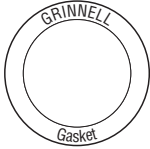
	Nominal Size	Part No. “E” EPDM	Part No. “T” Nitrile	List Price	Grade “O” Fluoroelastomer	List Price
	2"	71H20EPDME	71H20NITRILS	\$36.00	71H20FLUORO	POA
2½"	71H25EPDME	71H25NITRILS	\$42.50	71H25FLUORO	POA	
3"	71H30EPDME	71H30NITRILS	\$45.50	71H30FLUORO	POA	
4"	71H40EPDME	71H40NITRILS	\$58.50	71H40FLUORO	POA	
5"	71H50EPDME	71H50NITRILS	\$70.50	71H50FLUORO	POA	
6"	7160EPDMEP	7160NITRILSP	\$78.50	7160FLUOROP	POA	
8"	7180EPDMEP	7180NITRILSP	\$105.50	7180FLUOROP	POA	
10"	7110EPDMEP	7110NITRILSP	\$134.00	7110FLUOROP	POA	
12"	7112EPDMEP	7112NITRILSP	\$155.50	7112FLUOROP	POA	

 Orders for items in shaded areas *cannot* be cancelled or returned.

Technical Data Sheet: G155
#71 Flange Adapter Replacement
“E” EPDM Gasket, “T” Nitrile Gasket

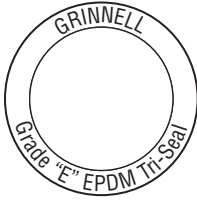
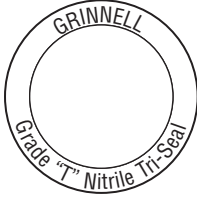
 	Nominal Size	Part No. “E” EPDM	Part No. “T” Nitrile	List Price
	2"	7120EPDME	7120NITRILS	\$36.00
2½"	7125EPDME	7125NITRILS	\$42.50	
3"	7130EPDME	7130NITRILS	\$45.50	
4"	7140EPDME	7140NITRILS	\$58.50	
5"	7150EPDME	7150NITRILS	\$70.50	
6"	7160EPDME	7160NITRILS	\$78.50	
8"	7180EPDME	7180NITRILS	\$105.50	
10"	7110EPDME	7110NITRILS	\$134.00	
12"	7112EPDME	7112NITRILS	\$155.50	
14"	7114EPDME	7114NITRILS	\$192.00	
16"	7116EPDME	7116NITRILS	\$213.00	
18"	7118EPDME	7118NITRILS	\$310.50	
20"	7121EPDME	7121NITRILS	\$334.50	
24"	7124EPDME	7124NITRILS	\$371.00	

 Orders for items in shaded areas *cannot* be cancelled or returned.

Technical Data Sheet: G610
#71 Flange Washer Adapter, Carbon Steel or Stainless Steel

	Nominal Size	Carbon Steel		Stainless Steel	
		Part Number	List Price	Part Number	List Price
2"	7120FWC	\$112.50	7120FW	POA	
2½"	7125FWC	\$118.50	7125FW	POA	
3"	7130FWC	\$138.50	7130FW	POA	
4"	7140FWC	\$161.00	7140FW	POA	
5"	7150FWC	\$194.00	7150FW	POA	
6"	7160FWC	\$222.00	7160FW	POA	
8"	7180FWC	\$279.50	7180FW	POA	
10"	7110FWC	\$386.50	7110FW	POA	
12"	7112FWC	\$564.50	7112FW	POA	
14"	7114FWC	\$615.00	–	–	
16"	7116FWC	\$1,092.00	–	–	
18"	7118FWC	\$1,164.50	–	–	
20"	7121FWC	POA	–	–	
24"	7124FWC	POA	–	–	

 Orders for items in shaded areas *cannot* be cancelled or returned.

Technical Data Sheet: G610

 See latest catalog or technical data sheets for specific approvals, listings, and design parameters.
 POA = Price on availability. Prices subject to change without notice.

Mechanical Products Section 12 – Gaskets & Spare Parts



#730 Replacement "E" EPDM Gasket

	<i>Nominal Size</i>	<i>"E" EPDM Gasket</i>	<i>"T" Nitrile Gasket</i>	<i>List Price</i>
	2" x 1/2"	730EGS-1	730TGS-1	\$19.00
	2" x 3/4"	730EGS-1	730TGS-1	\$19.00
	2" x 1"	730EGS-1	730TGS-1	\$19.00
	2" x 1 1/4"	730EGS-2	730TGS-2	\$22.00
	2" x 1 1/2"	730EGS-2	730TGS-2	\$22.00
	2 1/2" x 1 1/2"	730EGS-1	730TGS-1	\$19.00
	2 1/2" x 3/4"	730EGS-1	730TGS-1	\$19.00
	2 1/2" x 1"	730EGS-1	730TGS-1	\$19.00
	2 1/2" x 1 1/4"	730EGS-3	730TGS-3	\$22.00
	2 1/2" x 1 1/2"	730EGS-3	730TGS-3	\$22.00
	2 1/2" x 2"	730EGS-3	730TGS-3	\$22.00
	3" x 1 1/2"	730EGS-1	730TGS-1	\$19.00
	3" x 3/4"	730EGS-1	730TGS-1	\$19.00
	3" x 1"	730EGS-1	730TGS-1	\$19.00
	3" x 1 1/4"	730EGS-2	730TGS-2	\$22.00
	3" x 1 1/2"	730EGS-3	730TGS-3	\$22.00
	3" x 2"	730EGS-4	730TGS-4	\$22.00
	4" x 1 1/2"	730EGS-1	730TGS-1	\$19.00
	4" x 3/4"	730EGS-1	730TGS-1	\$19.00
	4" x 1"	730EGS-1	730TGS-1	\$19.00
	4" x 1 1/4"	730EGS-2	730TGS-2	\$22.00
	4" x 1 1/2"	730EGS-3	730TGS-3	\$22.00
	4" x 2"	730EGS-4	730TGS-4	\$22.00
	4" x 2 1/2"	730EGS-5	730TGS-5	\$24.50
	4" x 3"	730EGS-7	730TGS-7	\$27.50
	5" x 1 1/2"	730EGS-3	730TGS-3	\$22.00
	5" x 2"	730EGS-4	730TGS-4	\$22.00
	5" x 2 1/2"	730EGS-5	730TGS-5	\$24.50
	5" x 3"	730EGS-7	730TGS-7	\$27.50
	6" x 1 1/4"	730EGS-3	730TGS-3	\$22.00
	6" x 1 1/2"	730EGS-3	730TGS-3	\$22.00
	6" x 2"	730EGS-4	730TGS-4	\$22.00
6" x 2 1/2"	730EGS-6	730TGS-6	\$24.50	
6" x 3"	730EGS-8	730TGS-8	\$27.50	
6" x 4"	730EGS-9	730TGS-9	\$36.00	
8" x 2 1/2"	730EGS-6	730TGS-6	\$24.50	
8" x 3"	730EGS-8	730TGS-8	\$27.50	
8" x 4"	730EGS-9	730TGS-9	\$36.00	

Orders for items in shaded areas **cannot** be cancelled or returned.

Technical Data Sheet: G610

Introduction
Couplings & Fittings
Mechanical Tees
Valves
Circuit Balancing Valves
Accessories
Copper Systems
Stainless Steel Systems
Plain End Systems
Stainless Steel G-PRESS
HDPE Systems
Gaskets & Spare Parts
Preparation Equipment
Miscellaneous
Indices

Replacement Gaskets
EPDM “E” Gaskets, Nitrile “T” Gaskets For #702 Outlet Coupling

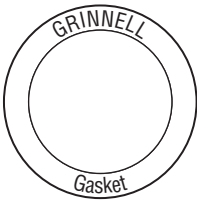
	<i>Nominal Size</i>	<i>Grade “E” EPDM Part No.</i>	<i>Grade “T” Nitrile Part No.</i>	<i>List Price</i>
	1½" x ½"	7021505EPDME	7021505NITRILS	\$68.50
	1½" x ¾"	7021575EPDME	7021575NITRILS	\$68.50
	1½" x 1"	7021501EPDME	7021501NITRILS	\$68.50
	2" x ½"	7022005EPDME	7022005NITRILS	\$69.50
	2" x ¾"	7022075EPDME	7022075NITRILS	\$69.50
	2" x 1"	7022001EPDME	7022001NITRILS	\$69.50
	2½" x ½"	7022505EPDME	7022505NITRILS	\$142.00
	2½" x ¾"	7022575EPDME	7022575NITRILS	\$142.00
	2½" x 1"	7022501EPDME	7022501NITRILS	\$142.00
2½" x 1¼"	7022513EPDME	7022513NITRILS	\$158.00	
2½" x 1½"	7022515EPDME	–	\$158.00	
3" x ¾"	7023075EPDME	7023075NITRILS	\$115.50	
3" x 1"	7023001EPDME	7023001NITRILS	\$163.00	
3" x 1¼"	7023013EPDME	7023013NITRILS	\$163.00	
3" x 1½"	7023015EPDME	7023015NITRILS	\$163.00	
4" x ¾"	7024075EPDME	7024075NITRILS	\$163.00	
4" x 1"	7024001EPDME	7024001NITRILS	\$163.00	
4" x 1½"	7024015EPDME	7024015NITRILS	\$252.50	
4" x 2"	7024020EPDME	7024020NITRILS	\$252.50	
6" x 1"	7026001EPDME	7026001NITRILS	\$330.00	
6" x 1½"	7026015EPDME	7026015NITRILS	\$330.00	
6" x 2"	7026020EPDME	7026020NITRILS	\$330.00	

 Orders for items in shaded areas *cannot* be cancelled or returned.

Technical Data Sheet: G610
Replacement Gaskets
with Grade “EHT” EPDM or Grade “T” Nitrile Center-Stop Push-On Style Gasket
For #740 Rapid Installation Pivot-Bolt (GRIP) Rigid Coupling

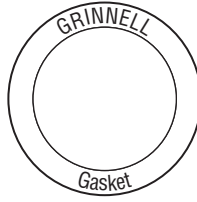
	<i>Nominal Size</i>	<i>Grade “E” EPDM Part No.</i>	<i>Grade “T” Nitrile Part No.</i>	<i>List Price</i>
	2"	74020EPDME	74020NITRILS	\$62.50
	2½"	74025EPDME	74025NITRILS	\$68.50
	3"	74030EPDME	74030NITRILS	\$78.50
	4"	74040EPDME	74040NITRILS	\$105.00
	5"	74050EPDME	74050NITRILS	\$149.50
	6"	74060EPDME	74060NITRILS	\$176.50
	8"	74080EPDME	74080NITRILS	\$256.50

 Orders for items in shaded areas *cannot* be cancelled or returned.

Technical Data Sheet: G144

**Replacement Gaskets – Grade “EN” Tri-Seal
(for #672 Coupling)**

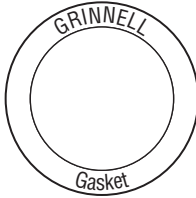
	Nominal Size	Part Number	List Price
	2"	20EN3	\$54.50
	2½"	25EN3	\$59.00
	3"	30EN3	\$62.50
	4"	40EN3	\$90.50
	5"	50EN3	\$148.50
	6"	60EN3	\$195.50
	8"	80EN3	\$303.50

Orders for items in shaded areas *cannot* be cancelled or returned.

Technical Data Sheet: G610

**Replacement Gaskets – Grade “EHT” EPDM Center-Stop Push-On Style Gasket
(for #640 Coupling)**

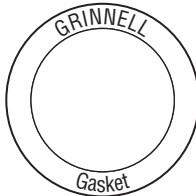
	Nominal Size	Part Number	List Price
	2"	964020EN3	\$52.00
	2½"	964025EN3	\$56.50
	3"	964030EN3	\$60.00
	4"	964040EN3	\$86.50
	5"	964050EN3	\$144.00
	6"	964060EN3	\$188.00
	8"	964080EN3	\$293.50

Orders for items in shaded areas *cannot* be cancelled or returned.

Technical Data Sheet: G610

**Replacement Gaskets – Grade “EH” EPDM Gasket
(for #616 Reducing Coupling)**

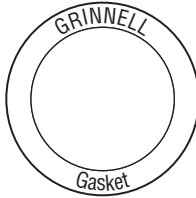
	Nominal Size	Part Number	List Price
	2½" x 2"	6162520NSF	\$51.00
	3" x 2"	6163020NSF	\$58.50
	3" x 2½"	6163025NSF	\$58.50
	4" x 2½"	6164025NSF	\$68.00
	4" x 3"	6164030NSF	\$70.50
	5" x 4"	6165040NSF	\$82.50
	6" x 4"	6166040NSF	\$93.00

Orders for items in shaded areas *cannot* be cancelled or returned.

Technical Data Sheet: G610

Introduction
Couplings & Fittings
Mechanical Tees
Valves
Circuit Balancing Valves
Accessories
Copper Systems
Stainless Steel Systems
Plain End Systems
Stainless Steel G-PRESS
HDPE Systems
Gaskets & Spare Parts
Preparation Equipment
Miscellaneous
Indices

**Replacement Gaskets – Grade “EN” EPDM Gasket
 (for #617 Transition Coupling for Joining IPS to Copper Tubing)**

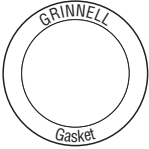
	Nominal Size	Part Number	List Price
	2"	61720NSF	\$64.00
	2½"	61725NSF	\$69.00
	3"	61730NSF	\$75.00
	4"	61740NSF	\$86.50

 Orders for items in shaded areas *cannot* be cancelled or returned.

Technical Data Sheet: G610
**Replacement Gaskets – Grade “EN” EPDM
 (for #61H Flange Adapter - Hinged)**

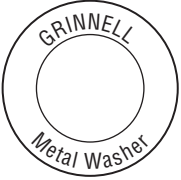
	Nominal Size	Part Number	List Price
	2"	61H20NSF	\$43.50
	2½"	61H25NSF	\$49.00
	3"	61H30NSF	\$53.00
	4"	61H40NSF	\$66.50
	5"	61H50NSF	\$80.50
	6"	61H60NSF	\$92.50

 Orders for items in shaded areas *cannot* be cancelled or returned.

Technical Data Sheet: G610
**Replacement Gaskets – Grade “EN” EPDM
 (for #61 Flange Adapter)**

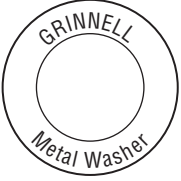
	Nominal Size	Part Number	List Price
	2"	6120NSF	\$43.50
	2½"	6125NSF	\$49.00
	3"	6130NSF	\$53.00
	4"	6140NSF	\$66.50
	5"	6150NSF	\$80.50
	6"	6160NSF	\$92.50

 Orders for items in shaded areas *cannot* be cancelled or returned.

Technical Data Sheet: G610

**Phenolic Washer
 (for #61 Flange Adapter)**

	Nominal Size	Part Number	List Price
	2"	61PW20	\$68.50
	2½"	61PW25	\$74.00
	3"	61PW30	\$79.50
	4"	61PW40	\$126.00
	5"	61PW50	\$136.50
	6"	61PW60	\$155.00

Orders for items in shaded areas **cannot** be cancelled or returned.

Technical Data Sheet: G610

**Replacement Gaskets
 EPDM "E" Gaskets, Nitrile "T" Gaskets For #909 Plain End Coupling**

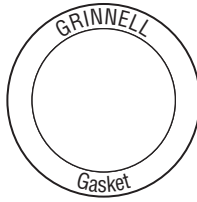
	Nominal Size	Grade "E" EPDM Part No.	Grade "T" Nitrile Part No.	List Price
	2"	90920EPDME	90920NITRILS	\$55.00
	2½"	90925EPDME	90925NITRILS	\$58.50
	3"	90930EPDME	90930NITRILS	\$64.00
	4"	90940EPDME	90940NITRILS	\$92.00
	6"	90960EPDME	90960NITRILS	\$132.00
	8"	90980EPDME	90980NITRILS	\$171.50
	10"	90910EPDME	90910NITRILS	\$219.50
	12"	90912EPDME	90912NITRILS	\$266.50
	14"	90914EPDME	90914NITRILS	\$404.50
	16"	90916EPDME	90916NITRILS	\$479.00
	18"	90918EPDME	90918NITRILS	\$764.50

Orders for items in shaded areas **cannot** be cancelled or returned.

Technical Data Sheet: G610

Introduction
 Couplings & Fittings
 Mechanical Tees
 Valves
 Circuit Balancing Valves
 Accessories
 Copper Systems
 Stainless Steel Systems
 Plain End Systems
 Stainless Steel G-PRESS
 HDPE Systems
 Gaskets & Spare Parts
 Preparation Equipment
 Miscellaneous
 Indices

HDPE – #9094 Replacement Gaskets “E”

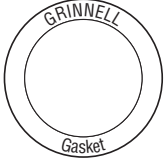
	<i>Nominal Size</i>	<i>Model Number</i>	<i>List</i>
	4"	909440EPDME	\$180.00
	6"	909460EPDME	\$183.00
	8"	909480EPDME	\$187.50

 Orders for items in shaded areas *cannot* be cancelled or returned.

Technical Data Sheet: G610
HDPE – #9095 Replacement Gaskets “E”

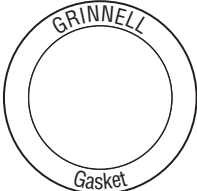
	<i>Nominal Size</i>	<i>Model Number</i>	<i>List</i>
	2"	909520EPDME	\$51.50
	3"	909530EPDME	\$60.00
	4"	909540EPDME	\$86.50
	6"	909560EPDME	\$124.00
	8"	909580EPDME	\$161.00
	10"	909510EPDME	\$207.00
	12"	909512EPDME	\$251.00
	14"	909514EPDME	\$381.50
	16"	909516EPDME	\$451.50
	18"	909518EPDME	\$473.00
	20"	909521EPDME	\$511.00

 Orders for items in shaded areas *cannot* be cancelled or returned.

Technical Data Sheet: G610
HDPE – #9097 Replacement Gaskets “E”

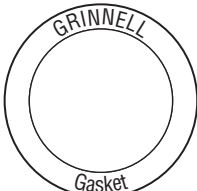
	<i>Nominal Size</i>	<i>Model Number</i>	<i>List</i>
	2"	909720EPDME	\$41.50
	3"	909730EPDME	\$52.00
	4"	909740EPDME	\$65.00
	6"	909760EPDME	\$90.00
	8"	909780EPDME	\$123.50
	10"	909710EPDME	\$154.50
12"	909712EPDME	\$180.00	

 Orders for items in shaded areas *cannot* be cancelled or returned.

Technical Data Sheet: G610

Mechanical Products

Section 12 – Gaskets & Spare Parts

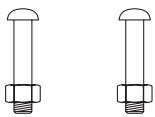

Coupling Nut and Bolt Kit						
	Nominal Size	Qty/Kit	Carbon Steel		Stainless Steel	
			Part Number	List Price	Part Number	List Price
				3/8" x 2 1/4"	2	NB37225
	1/2" x 3"	2	NB50300	\$21.00	NBSS50300	\$121.00
	1/2" x 3 5/8"	1	NB50358	\$10.50	-	-
	5/8" x 2 3/4"	2	NB62275	\$25.00	-	-
	5/8" x 3 1/4"	2	NB62325	\$25.00	NBSS62325	\$118.50
	5/8" x 3 1/2"	2	NB62350	\$29.50	-	-
	5/8" x 4 1/2"	1	NB62415	\$14.50	-	-
	5/8" x 4 3/4"	2	NB62475	\$41.50	NBSS62475	\$769.00
	3/4" x 4 1/4"	2	NB75425	\$28.50	-	-
	3/4" x 4 3/4"	2	NB75475	\$38.00	NBSS75475	\$508.00
	7/8" x 5 1/2"	2	NB87550	\$58.00	-	-
	7/8" x 6 1/2"	2	NB87650	\$63.50	NBSS87650	\$681.50
	1" x 5 1/2"	3	NB10550	\$63.50	NBSS10550	\$730.50
	1" x 6 1/2"	2	NB10650	\$67.00	NBSS10650	\$915.50
	1 1/8" x 5 3/4"	4	NB12575	\$85.50	-	-

Orders for items in shaded areas **cannot** be cancelled or returned.

All standard couplings can be provided with stainless steel nuts and bolts upon request.

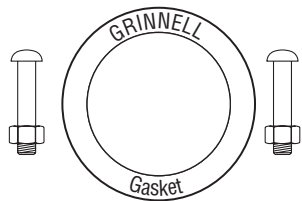
#71 Nut, Bolt, and Gasket Kit			
	Nominal Size	Part Number	List Price
	2"	50240P	POA
	2 1/2"	50241P	POA
	3"	50242P	POA
	4"	50243P	POA
	5"	50248P	POA
	6"	50244P	POA
	8"	50245P	POA
	10"	50246P	POA
	12"	50247P	POA

Orders for items in shaded areas **cannot** be cancelled or returned.

Technical Data Sheet: G610

Introduction
Couplings & Fittings
Mechanical Tees
Valves
Circuit Balancing Valves
Accessories
Copper Systems
Stainless Steel Systems
Plain End Systems
Stainless Steel G-PRESS
HDPE Systems
Gaskets & Spare Parts
Preparation Equipment
Miscellaneous
Indices

Pipe Tape Chrome Plated with GRINNELL Logo

	<i>Part Number</i>	<i>List Price</i>
	PT1000	\$79.50

GRINNELL Gasket Lubricant

	<i>Nominal Size</i>	<i>Part Number</i>	<i>List Price</i>
	1 Quart	32005	\$46.00

 Orders for items in shaded areas **cannot** be cancelled or returned.

GRINNELL Silicone Gasket Lubricant
Recommended for use with Tri-Seal Gasket
Dow Corning* #DC No. 7

	<i>Nominal Size</i>	<i>Part Number</i>	<i>List Price</i>
	5.3 oz. Tube	32037	\$150.50
	8 lb. Can	32038	\$2,733.50

 Orders for items in shaded areas **cannot** be cancelled or returned.

* Dow Corning is a trademark of Dow Corning Corporation.

 See latest catalog or technical data sheets for specific approvals, listings, and design parameters.
 POA = Price on availability. Prices subject to change without notice.

Mechanical Products Section 13 – Preparation Equipment



Roll Grooving Machine Selection Chart											
Machine Type	Pace Model	Size Range				Drive	Rolls Supplied			Part No.	List Price **
		Sch. 40	Sch. 10	Std. Wall	Copper		Size	Steel	Copper		
Portable with Electric Motor	1112	1" – 12"	–	–	2" – 8"	1½ HP, 110V	1" – 12"	■		41048	\$8,294.00
	1023	1¼" – 12"	–	12" – 24"	2" – 8"	1½ HP, 110V	1¼" – 12"	■		41029	\$12,266.50
							2" – 12"	■		41250	\$11,674.50
							1¼" – 24"	■		41251	\$13,666.00
							2" – 24"	■		41252	\$13,068.00
Portable for Ridgid® 300	1012	1" – 12"	–	–	2" – 8"	Ridgid® 300	1" – 12"	■		41041	\$4,603.50
	1022	1¼" – 12"	–	12" – 16"	2" – 8"	Ridgid® 300	1¼" – 16"	■		41027	\$10,361.50
	1041	1" – 6"	1" – 12"	–	2" – 8"	Ridgid® 300	1" – 12"	■		41018	\$3,224.00
Mini-Mites	1039-66	1¼" – 6"	–	–	2" – 8"	Ridgid® 300, Hand Crank	2" – 8" CTS		■	41047	\$916.50
	1039	1¼" – 6"	–	–	2" – 8"	Ridgid® 300, Hand Crank	1¼" – 6" IPS	■		41017	\$916.50
	1034	1¼" – 6"	–	–	–	Ridgid® 300	1¼" – 6" IPS	■		41015	\$682.00
	1066	–	–	–	2" – 8"	Ridgid® 300	2" – 8" CTS		■	41014	\$682.00
Automated	2021	1¼" – 12"	–	12" – 24"	2" – 8"	3 HP, 220V	1¼" – 12"	■		41257	\$21,559.00
							2" – 12"	■		41258	\$20,966.50
							1¼" – 24"	■		41032	\$22,959.00
							2" – 24"	■		41259	\$22,305.00
	2050	4" – 12"	4" – 30"	12" – 30"	–	5 HP, 220V	4" – 6"	■		41033	\$40,671.00
2112	1" – 12"	–	–	2" – 8"	½ HP, 110V	1" – 12"	■		41210	POA	
Portable Cut Groover	1000	2" – 8"	–	–	–	1 HP, 115V	2" – 8"			41260	\$9,656.00
		2" – 12"	–	–	–		2" – 12"			41261	\$10,564.00

** Accessories not included, refer to Accessory Table Below.

Accessories						
Item	Pace Model	Size Range	Capacity	Part No.	List Price	
Pipe Stands	4031	1" – 4"	600 Lbs.	41037	\$492.50	
	4000	2" – 8"	900 Lbs.	41038	\$608.00	
	4033	2" – 14"	1,200 Lbs.	41039	\$762.00	
	4040	12" – 24"	4,000 Lbs.	41040	\$1,933.00	
Nipple Bracket	4037	Fits Model 1021 / 22 / 23 / 2021		–	41035	\$615.50
	4045	4" – 12" Fits Model 1012 / 1112		–	41512	\$511.50
Mounting Feet	4039	Fits Portable Roll Groovers and Model 1000		–	41034	\$155.50
	4046	PA Mounting Feet		–	41013	\$155.50
Porta-Bore	3013	Up to 4¼" Holes in Pipe 1¼" – 12"		–	41049	\$2,542.00

Introduction
Couplings & Fittings
Mechanical Tees
Valves
Circuit Balancing Valves
Accessories
Copper Systems
Stainless Steel Systems
Plain End Systems
Stainless Steel G-PRESS
HDPE Systems
Gaskets & Spare Parts
Preparation Equipment
Miscellaneous
Indices

Roll Selection Chart

Machine	Pipe	Size	Top		Size	Bottom		Parts	Part Number	List Price
			Part No.	List Price		Part No.	List Price			
1021, 1023, 2021	Sch. 40	1 1/4" – 1 1/2"	41262	\$344.00	1 1/4" – 1 1/2"	41281	\$249.50			
		2" – 3 1/2"	41263	\$300.00	2" – 3 1/2"	41282	\$231.50			
		4" – 6"	41264	\$267.50	4" – 6"	41283	\$351.50			
		8" – 12"	41265	\$267.50	8" – 12"	41284	\$418.00			
	Std. Wall	14" – 16"	41266	\$250.50	14" – 16"	41285	\$460.00			
		18" – 24"	41267	\$250.50	18" – 24"	41286	\$460.00			
Copper Tube	2" – 8"	41268	\$300.00	2" – 8"	41287	\$231.50	Depth Gauge 4043	41509	\$34.50	
1010, 2010	Sch. 10, Sch. 40	1 1/2" – 6"	41269	\$250.50	1 1/2"	41288	\$231.50			
			–	–	2" – 3 1/2"	41289	\$231.50			
			–	–	4" – 6"	41290	\$337.00			
	Sch. 10	8" – 12"	41270	\$250.50	8" – 12"	41291	\$337.00			
1040, 2040	Sch. 40	1" – 1 1/2"	41271	\$205.50	1" – 1 1/2"	41292	\$205.50			
		1" – 6"	41272	\$181.50	1" – 6"	41293	\$171.50			
		2" – 6"	41273	\$205.50	–	–				
	Sch. 10	8" – 12"	41274	\$181.50	8" – 12"	41294	\$284.00			
	Copper Tube	2" – 8"	41275	\$183.00	2" – 8"	41295	\$176.00	Depth Gauge 4021	41510	\$34.50
1012, 1112, 2112	Sch. 40	1" – 1 1/2"	41276	\$205.50	1" – 1 1/2"	41296	\$205.50			
		2" – 6"	41277	\$205.50	2" – 6"	41297	\$171.50			
		8" – 12"	41278	\$205.50	8" – 12"	41298	\$287.00			
	Copper Tube	2" – 8"	41506	\$205.50	2" – 8"	41507	\$176.00	Depth Gauge 4021	41510	\$34.50
1021, 1022, 1023, 2021	SS 10 Ga.				2" – 3 1/2"	41299	\$253.50			
					4" – 6"	41500	\$386.00			
					8" – 12"	41501	\$460.00			
					14" – 16"	41504	\$505.00			
					18" – 24"	41505	\$505.00			
1040, 1041, 1112, 2112	SS 10 Ga.				2" – 6"	41502	\$191.00			
					8" – 12"	41503	\$340.50			
1034, 1039	Sch. 40	1 1/4" – 6", w/ brg.	41279	\$48.00				1034 Drive Shaft 1 1/4" – 6"	41511	\$76.00
								1039 Drive Shaft 1 1/4" – 6"	41513	\$96.00
								Depth Gauge 4021	41510	\$34.50
1039	Copper Tube	2" – 8", w/ brg.	41280	\$62.00			Depth Gauge 4021	41510	\$34.50	
1066	Copper Tube	2" – 8", w/ brg.	41508	\$62.00				Drive Shaft 2" – 8"	41514	\$76.00
								Depth Gauge 4021	41510	\$34.50

Brg. = Bottom Roll Grooved

See latest catalog or technical data sheets for specific approvals, listings, and design parameters.

POA = Price on availability. Prices subject to change without notice.

Mechanical Products Section 14 – Miscellaneous



Grooved Couplings – Pieces Per Carton/Case								
Nominal Size	#740 Pivot-Bolt GRIP Coupling	#705 Flex Coupling	#707 HD Flex Coupling	#772 Rigid Coupling	#71 Flange Adapter	#770 Heavy Duty Coupling	Nominal Size	#716 Reducing Coupling
1"	-	-	40	-	-	-	2" x 1 1/2"	20
1 1/4"	-	32	-	32	-	-	2 1/2" x 2"	20
1 1/2"	-	32	480	28	-	-	3" x 2"	12
2"	350	480	385	385	210	385	3" x 2 1/2"	12
2 1/2"	300	350	350	350	210	315	4" x 2"	8
3"	240	270	240	240	124	24	4" x 2 1/2"	8
4"	120	175	150	150	124	12	4" x 3"	8
5"	120	96	80	100	30	-	5" x 4"	80
6"	80	100	64	80	30	6	6" x 4"	64
8"	48	48	36	44	30	33	6" x 5"	64
10"	-	24	24	24	24	18	8" x 6"	36
12"	-	20	20	20	24	20	-	-
14"	-	-	12	12	12	-	-	-
16"	-	-	12	12	6	-	-	-
18"	-	-	6	6	5	-	-	-
20"	-	-	3	3	5	-	-	-
24"	-	-	3	3	5	-	-	-

Grooved Fittings – Pieces Per Carton/Case				
Nominal Size	#210 90 Elbow	#201 45 Elbow	#219 Tee	#260 Cap
1 1/4"	40	45	28	294
1 1/2"	36	60	28	210
2"	18	24	10	140
2 1/2"	12	18	8	84
3"	6	10	12	63
4"	56	96	46	30
5"	35	140	36	392
6"	24	30	12	288
8"	11	16	8	160
10"	7	9	5	96
12"	5	9	8	63
14"	2	-	-	-
16"	-	-	-	-
18"	-	-	-	-
20"	-	-	-	-
24"	-	-	-	-
-	-	-	-	-
-	-	-	-	-
-	-	-	-	-
-	-	-	-	-



Grooved Fittings – Pieces Per Carton/Case		
Nom Size	#250 Conc Reducer	#251 Ecc Reducer
1 1/2" x 1 1/4"	70	-
2 1/2" x 1 1/4"	36	-
2 1/2" x 1 1/2"	36	-
2 1/2" x 2"	36	-
3" x 1 1/2"	24	-
3" x 2"	24	18
3" x 2 1/2"	24	18
4" x 2"	10	144
4" x 2 1/2"	10	144
4" x 3"	10	10
5" x 3"	147	147
5" x 4"	147	98
6" x 2"	72	-
6" x 2 1/2"	72	-
6" x 3"	72	36
6" x 4"	72	36
6" x 5"	216	36
8" x 3"	80	-
8" x 4"	40	-
8" x 5"	40	-
8" x 6"	32	-
10" x 6"	13	-
10" x 8"	13	-
12" x 6"	9	-
12" x 8"	9	-
12" x 10"	36	-

See latest catalog or technical data sheets for specific approvals, listings, and design parameters.
POA = Price on availability. Prices subject to change without notice.

Mechanical Products Section 14 – Miscellaneous



Grooved Fittings – Pieces Per Carton/Case					
Nominal Size	#730 Mechanical Tee	Nominal Size	#730 Mechanical Tee (cont.)	Nominal Size	#221 Reducing Tee
2" x 1/2"	15	4" x 1/2"	8	2" x 2" x 1 1/2"	24
2" x 3/4"	15	4" x 3/4"	8	2 1/2" x 2 1/2" x 2"	8
2" x 1"	15	4" x 1"	8	3" x 3" x 1"	12
2" x 1 1/4"	15	4" x 1 1/4"	8	3" x 3" x 1 1/2"	4
2" x 1 1/2"	12	4" x 1 1/2"	8	3" x 3" x 2"	3
2 1/2" x 1 1/2"	14	4" x 2"	6	3" x 3" x 2 1/2"	3
2 1/2" x 3/4"	14	4" x 2 1/2"	5	4" x 4" x 2"	46
2 1/2" x 1"	14	4" x 3"	4	4" x 4" x 3"	46
2 1/2" x 1 1/4"	14	5" x 2"	4	5" x 5" x 2 1/2"	18
2 1/2" x 1 1/2"	20	5" x 2 1/2"	8	5" x 5" x 3"	18
3" x 1/2"	11	6" x 1 1/2"	8	5" x 5" x 4"	36
3" x 3/4"	11	6" x 2"	7	6" x 6" x 2"	12
3" x 1"	11	6" x 2 1/2"	7	6" x 6" x 2 1/2"	48
3" x 1 1/4"	11	6" x 3"	6	6" x 6" x 3"	48
3" x 1 1/2"	11	6" x 4"	6	6" x 6" x 4"	48
3" x 2"	12	8" x 2 1/2"	4	8" x 8" x 4"	8
-	-	8" x 3"	4	8" x 8" x 6"	8
-	-	8" x 4"	4	-	-

Copper System Grooved Couplings – Pieces Per Carton/Case			
Nominal Size	#672 Rigid Coupling	#61 Flange Adapter	#640 Pivot-Bolt Rigid Couplings
2"	520	210	20
2 1/2"	385	21	16
3"	270	124	12
4"	175	124	8
5"	120	30	100
6"	100	30	100
8"	60	-	60

Introduction
Couplings & Fittings
Mechanical Tees
Valves
Circuit Balancing Valves
Accessories
Copper Systems
Stainless Steel Systems
Plain End Systems
Stainless Steel G-PRESS
HDPE Systems
Gaskets & Spare Parts
Preparation Equipment
Miscellaneous
Indices

Part No.	Page	Part No.	Page	Part No.	Page	Part No.	Page	Part No.	Page	Part No.	Page
01EPDME	88	18FLUORO3	90	21025GS	16	21915S	23	24FLUORO	89	2513025S	28
01FLUORO3	90	18NITRILS	88	21025S	16	21916GS	23	24FLUORO3	90	2514020GS	28
01NITRILS	88	18NITRILS3	88	21030GS	16	21916S	23	24NITRILS	88	2514020S	28
05SSPRESSE	85	20110GS	16	21030S	16	21920GS	23	24NITRILS3	88	2514025GS	28
05SSPRESSE	85	20110S	16	21040GS	16	21920S	23	2501060GS	27	2514025S	28
05SSPRESST	85	20112GS	16	21040S	16	21925GS	23	2501060S	27	2514030GS	28
08SSPRESSE	85	20112S	16	21050GS	16	21925S	23	2501080GS	27	2514030S	28
08SSPRESSE	85	20113GS	16	21050S	16	21930GS	23	2501080S	27	2515040GS	29
08SSPRESST	85	20113S	16	21060GS	16	21930S	23	2501210GS	27	2515040S	29
10EPDME	88	20115GS	16	21060S	16	21940GS	23	2501210S	27	2516030GS	29
10EPDME3	88	20115S	16	21080GS	16	21940S	23	2501240GS	27	2516030S	29
10FLUORO	89	20120GS	16	21080S	16	21950GS	23	2501240S	27	2516040GS	29
10FLUORO3	90	20120S	16	210L14GS	18	21950S	23	2501260GS	27	2516040S	29
10NITRILS	88	20125GS	16	210L14S	18	21960GS	23	2501260S	27	2516050GS	29
10NITRILS3	88	20125S	16	210L16GS	18	21960S	23	2501280GS	27	2516050S	29
10SILICONE	89	20130GS	16	210L16S	18	21980GS	23	2501280S	27	2520EPDME	91
10SSPRESSE	85	20130S	16	21113GS	17	21980S	23	2501513GS	27	2520NITRILS	91
10SSPRESSE	85	20140GS	16	21113S	17	21EPDME	88	2501513S	27	25EN3	95
10SSPRESST	85	20140S	16	21115GS	17	21EPDME3	88	2502513GS	27	25EPDME	88
12EPDME	88	20150GS	16	21115S	17	21FLUORO	89	2502513S	27	25EPDME3	88
12EPDME3	88	20150S	16	21120GS	17	21FLUORO3	90	2502515GS	27	25FLUORO	89
12FLUORO	89	2015EPDME	91	21120S	17	21NITRILS	88	2502515S	27	25FLUORO3	90
12FLUORO3	90	2015NITRILS	91	21125GS	17	21NITRILS3	88	2502520GS	27	25NITRILS	88
12NITRILS	88	20160GS	16	21125S	17	2212015GS	24	2502520S	27	25NITRILS3	88
12NITRILS3	88	20160S	16	21130GS	17	2212015S	24	2503015GS	27	25SILICONE	89
12SILICONE	89	20180GS	16	21130S	17	2212520GS	24	2503015S	27	26001GS	36
13EPDME	88	20180S	16	21140GS	17	2212520S	24	2503020GS	27	26001S	36
13EPDME3	88	201L14GS	18	21140S	17	2213010GS	24	2503020S	27	26010GS	36
13FLUORO	89	201L14S	18	21150GS	17	2213010S	24	2503025GS	27	26010S	36
13FLUORO3	90	201L16GS	18	21150S	17	2213015GS	24	2503025S	27	26010T1S	37
13NITRILS	88	201L16S	18	21160GS	17	2213015S	24	2504020GS	27	26010T75S	37
13NITRILS3	88	2063631	57	21160S	17	2213020GS	24	2504020S	27	26010TS	37
13SILICONE	89	2063633	57	21180GS	17	2213020S	24	2504025GS	27	26012GS	36
14EPDME	88	2063634	56	21180S	17	2213025GS	24	2504025S	27	26012S	36
14EPDME3	88	2063635	57	21213GS	17	2213025S	24	2504030GS	27	26012T1S	37
14FLUORO	89	2063636	56	21213S	17	2214020GS	24	2504030S	27	26012T75S	37
14FLUORO3	90	2063637	57	21215GS	17	2214020S	24	2505030GS	27	26012TS	37
14NITRILS	88	2063641	56	21215S	17	2214025GS	24	2505030S	27	26013GS	36
14NITRILS3	88	2063646	56	21220GS	17	2214025S	24	2505040GS	27	26013S	36
14SILICONE	89	2063651	56	21220S	17	2214030GS	24	2505040S	27	26013TS	37
15EPDME	88	20EN3	95	21225GS	17	2214030S	24	2506020GS	27	26015GS	36
15EPDME3	88	20EPDME	88	21225S	17	2215025GS	24	2506020S	27	26015S	36
15FLUORO	89	20EPDME3	88	21230GS	17	2215025S	24	2506025GS	27	26015TS	37
15FLUORO3	90	20FLUORO	89	21230S	17	2215030GS	24	2506025S	27	26020GS	36
15NITRILS	88	20FLUORO3	90	21240GS	17	2215030S	24	2506030GS	27	26020S	36
15NITRILS3	88	20NITRILS	88	21240S	17	2215040GS	24	2506030S	27	26020T1S	37
15SILICONE	89	20NITRILS3	88	21250GS	17	2215040S	24	2506040GS	27	26020T75S	37
15SSPRESSE	85	20SILICONE	89	21250S	17	2216020GS	24	2506040S	27	26020TS	37
15SSPRESSE	85	20SSPRESSE	85	21260GS	17	2216020S	24	2506050GS	27	26025GS	36
15SSPRESST	85	20SSPRESSE	85	21260S	17	2216025GS	24	2506050S	27	26025S	36
1659300	53	20SSPRESST	85	21280GS	17	2216025S	24	2508030GS	27	26025T1S	37
16EPDME	88	21010GS	16	21280S	17	2216030GS	24	2508030S	27	26025T75S	37
16EPDME3	88	21010S	16	21910GS	23	2216030S	24	2508040GS	27	26025TS	37
16FLUORO	89	21012GS	16	21910S	23	2216040GS	24	2508040S	27	26030GS	36
16FLUORO3	90	21012S	16	21912GS	23	2216040S	24	2508050GS	27	26030S	36
16NITRILS	88	21013GS	16	21912S	23	2218040GS	24	2508050S	27	26030T1S	37
16NITRILS3	88	21013S	16	21913GS	23	2218040S	24	2508060GS	27	26030T75S	37
16SILICONE	89	21015GS	16	21913S	23	2218060GS	24	2508060S	27	26030TS	37
18EPDME	88	21015S	16	21914GS	23	2218060S	24	2513020GS	28	26040GS	36
18EPDME3	88	21020GS	16	21914S	23	24EPDME	88	2513020S	28	26040S	36
18FLUORO	89	21020S	16	21915GS	23	24EPDME3	88	2513025GS	28	26040T1S	37

See latest catalog or technical data sheets for specific approvals, listings, and design parameters.
POA = Price on availability. Prices subject to change without notice.

Customer Service: (800) 558-5236

www.grinnell.com

Mechanical Products

Section 15 – Indices



Part No.	Page	Part No.	Page	Part No.	Page	Part No.	Page	Part No.	Page	Part No.	Page
26040T75S.	37	301L13GS	18	306125D	19	310203D	19	311253D.	21	312306D	21
26040TS	37	301L13S.	18	306126D	19	310205D	19	311255D.	21	312403D	21
26050GS	36	301L15GS	18	306143D	19	310206D	19	311256D.	21	312405D	21
26050S.	36	301L15S.	18	306145D	19	310213D	19	311303D.	21	312406D	21
26050T1S.	37	301L18GS	18	306146D	19	310215D	19	311305D.	21	312503D	21
26050T75S.	37	301L20GS	18	306163D	19	310216D	19	311306D.	21	312505D	21
26050TS	37	301L21GS	18	306165D	19	310243D	19	311403D.	21	312506D	21
26060GS	36	301L24GS	18	306166D	19	310245D	19	311405D.	21	312603D	21
26060S.	36	301L25GS	18	306183D	19	310246D	19	311406D.	21	312605D	21
26060T1S.	37	301L50GS	18	306185D	19	310253D	19	311503D.	21	312606D	21
26060T75S.	37	301L80GS	18	306186D	19	310255D	19	311505D.	21	312803D	21
26060TS	37	3020EPDME.	91	306203D	19	310256D	19	311506D.	21	312805D	21
26080GS	36	3020NITRILS ...	91	306205D	19	310303D	19	311603D.	21	312806D	21
26080S.	36	3025EPDME.	91	306206D	19	310305D	19	311605D.	21	31405GS	32
26080T1S.	37	3025NITRILS ...	91	306213D	19	310306D	19	311606D.	21	31410GS	32
26080T75S.	37	303103D	20	306215D	19	310403D	19	311803D.	21	31412GS	32
26080TS	37	303105D	20	306216D	19	310405D	19	311805D.	21	31413GS	32
301103D.	20	303106D	20	306243D	19	310406D	19	311806D.	21	31413S.	32
301105D.	20	303123D	20	306245D	19	310503D	19	312103D	21	31414GS	32
301106D.	20	303125D	20	306246D	19	310505D	19	312105D	21	31415GS	32
301123D.	20	303126D	20	306253D	19	310506D	19	312106D	21	31415S.	32
301125D.	20	303143D	20	306255D	19	310603D	19	31210GS	17	31416GS	32
301126D.	20	303145D	20	306256D	19	310605D	19	31210S.	17	31416S.	32
301143D.	20	303146D	20	306303D	19	310606D	19	312123D	21	31418GS	32
301145D.	20	303163D	20	306305D	19	310803D	19	312125D	21	31421GS	32
301146D.	20	303165D	20	306306D	19	310805D	19	312126D	21	31424GS	32
301163D.	20	303166D	20	306403D	19	310806D	19	31212GS	17	31450S.	32
301165D.	20	303183D	20	306405D	19	310L10GS	18	31212S.	17	31513GS	22
301166D.	20	303185D	20	306406D	19	310L20GS	18	312143D	21	31515GS	22
301183D.	20	303186D	20	306503D	19	310L25GS	18	312145D	21	31540GS	22
301185D.	20	303203D	20	306505D	19	310LR13GS ...	18	312146D	21	31560GS	22
301186D.	20	303205D	20	306506D	19	310LR15GS ...	18	31214GS	17	3161208GS ...	22
301203D	20	303206D	20	306603D	19	310LR18GS ...	18	31214S.	17	3161210GS ...	22
301205D	20	303213D	20	306605D	19	310LR21GS ...	18	312163D	21	31918GS	23
301206D	20	303215D	20	306606D	19	311103D	21	312165D	21	31921GS	23
301213D	20	303216D	20	306803D	19	311105D	21	312166D	21	32005.	100
301215D	20	303243D	20	306805D	19	311106D	21	31216GS	17	32010GS	23
301216D	20	303245D	20	306806D	19	311123D	21	31216S.	17	32010S.	23
301243D	20	303246D	20	30EN3	95	311125D	21	312183D	21	32012GS	23
301245D	20	303253D	20	30EPDME	88	311126D	21	312185D	21	32012S.	23
301246D	20	303255D	20	30EPDME3	88	311143D	21	312186D	21	32013GS	23
301253D	20	303256D	20	30FLUORO	89	311145D	21	31218GS	17	32013S.	23
301255D	20	303303D	20	30FLUORO3	90	311146D	21	31218S.	17	32015GS	23
301256D	20	303305D	20	30NITRILS ...	88	311163D	21	312203D	21	32020GS	23
301303D	20	303306D	20	30NITRILS3 ...	88	311165D	21	312205D	21	32025GS	23
301305D	20	303403D	20	30SILICONE ...	89	311166D	21	312206D	21	32030GS	23
301306D	20	303405D	20	310103D	19	311183D	21	312213D	21	32037.	100
301403D	20	303406D	20	310105D	19	311185D	21	312215D	21	32038.	100
301405D	20	303503D	20	310106D	19	311186D	21	312216D	21	32040GS	23
301406D	20	303505D	20	310123D	19	31118S.	17	31221GS	17	32050GS	23
301503D	20	303506D	20	310125D	19	311203D	21	31221S.	17	32050S.	23
301505D	20	303603D	20	310126D	19	311205D	21	312243D	21	32060GS	23
301506D	20	303605D	20	310143D	19	311206D	21	312245D	21	32080GS	23
301603D	20	303606D	20	310145D	19	311213D	21	312246D	21	32080S.	23
301605D	20	303803D	20	310146D	19	311215D	21	31224GS	17	3211005GS ...	24
301606D	20	303805D	20	310163D	19	311216D	21	31224S.	17	3211205GS ...	24
301803D	20	303806D	20	310165D	19	31121S.	17	312253D	21	3211230GS ...	24
301805D	20	306103D	19	310166D	19	311243D	21	312255D	21	3211410GS ...	24
301806D	20	306105D	19	310183D	19	311245D	21	312256D	21	3211460GS ...	24
301L10GS	18	306106D	19	310185D	19	311246D	21	312303D	21	3211610GS ...	25
301L12GS	18	306123D	19	310186D	19	31124S.	17	312305D	21	3211614GS ...	25

Introduction
Couplings & Fittings
Mechanical Tees
Valves
Circuit Balancing Valves
Accessories
Copper Systems
Stainless Steel Systems
Plain End Systems
Stainless Steel G-PRESS
HDPE Systems
Gaskets & Spare Parts
Preparation Equipment
Miscellaneous
Indices

Customer Service: (800) 558-5236
www.grinnell.com

See latest catalog or technical data sheets for specific approvals, listings, and design parameters.
POA = Price on availability. Prices subject to change without notice.

Part No.	Page	Part No.	Page	Part No.	Page	Part No.	Page	Part No.	Page	Part No.	Page
3211810GS	25	3251412GS	33	3315030GS	34	3511510S	28	3932540GS	31	401806A	66
3211812GS	25	3251460GS	33	3315030S	34	3511513GS	28	3935060GS	31	401806AD	66
3211814GS	25	3251480GS	33	34114GS	38	3511610S	29	3936060GS	31	4020EPDME	91
3211816GS	25	3251610GS	33	34115GS	38	3511612GS	29	3938060GS	31	4020NITRILS	91
3211880GS	25	3251612GS	33	34116GS	38	3511680S	29	3951014S	31	4025EPDME	91
3212114GS	25	3251614GS	33	34118GS	38	3511814GS	29	39580125GS	31	4025NITRILS	91
3212116GS	25	3251660GS	33	34120GS	38	3511816GS	29	39580125S	31	4030EPDME	91
3212118GS	25	3251680GS	33	34121GS	38	3512010GS	28	3975015S	39	4030NITRILS	91
3212414S	25	3251814GS	33	34210GS	38	3512015GS	28	3975025S	39	40501EN	65
3212420S	25	3251816GS	33	34210S	38	3512112S	29	3978060S	39	40501T	65
3212510GS	24	3251860GS	33	34212GS	38	3512116GS	29	3985015S	40	40513EN	65
3214010GS	24	3251880GS	33	34212S	38	3512118GS	29	3985025S	40	40513EN3	65
3216050GS	24	3252112GS	33	34214GS	38	3512410GS	29	3988060S	40	40513T	65
3218025GS	24	3252114GS	33	34214S	38	3512410S	29	3995015S	41	40513T3	65
3231020GS	26	3252116GS	33	34215GS	38	3512418GS	29	3995025S	41	40515EN	65
3231030GS	26	3252421GS	33	34215S	38	3512421GS	29	3998060S	41	40515EN3	65
3231030S	26	3253020GS	33	34216GS	38	3512421S	29	401014A	66	40515T	65
3231040GS	26	3254030GS	33	34216S	38	3512510GS	28	401014AD	66	40515T3	65
3231040S	26	3255025S	33	34218GS	38	3512510S	28	401016A	66	40520EN	65
3231050GS	26	3256025GS	33	34218S	38	3512513GS	28	401016AD	66	40520EN3	65
3231050S	26	3256025S	33	34220S	38	3512515GS	28	401104A	66	40520T	65
3231060GS	26	32713GS	36	34221GS	38	3513010GS	28	401104AD	66	40520T3	65
3231060S	26	32713S	36	34221S	38	3513010S	28	401106A	66	40525EN	65
3231080GS	26	32714GS	36	34224GS	38	3513013GS	28	401106AD	66	40525EN3	65
3231080S	26	32714S	36	34224S	38	3513015GS	28	401124A	66	40525T	65
3231210GS	26	32715GS	36	34225GS	38	3514010GS	28	401124AD	66	40525T3	65
3231210S	26	32716S	36	34230GS	38	3514010S	28	401126A	66	40530EN	65
3231230GS	26	32718GS	36	34240GS	38	3514013GS	28	401126AD	66	40530EN3	65
3231230S	26	32718S	36	34280GS	38	3514015GS	28	401134A	66	40530T	65
3231240GS	26	32721GS	36	3501050GS	27	3515030GS	29	401134AD	66	40530T3	65
3231240S	26	32721S	36	3501301GS	27	3516025GS	29	401136A	66	40540EN	65
3231250GS	26	32724GS	36	3501301S	27	3518030GS	29	401136AD	66	40540EN3	65
3231250S	26	32724S	36	3501460GS	28	3518040GS	29	401154A	66	40540T	65
3231260GS	26	32750GS	36	3501480GS	28	3518050GS	29	401154AD	66	40540T3	65
3231260S	26	3301010GS	35	3501610GS	28	3518060GS	29	401156A	66	40550EN	65
3231280GS	26	3301030GS	35	3501614GS	28	3722013GS	30	401156AD	66	40550EN3	65
3231280S	26	3301030S	35	3501680GS	28	3722513GS	30	401204A	66	40550T	65
3231513GS	25	3301040S	35	3501812GS	28	3722515GS	30	401204AD	66	40550T3	65
3232013GS	25	3301210S	35	3501814GS	28	3723013GS	30	401206A	66	40560EN	65
3234013GS	25	3301212GS	35	3501816GS	28	3724013GS	30	401206AD	66	40560EN3	65
3235025GS	25	3301230GS	35	3502112GS	28	3725030GS	30	401254A	66	40560T	65
3235030S	25	3301260GS	35	3502114GS	28	3725030S	30	401254AD	66	40560T3	65
3235040GS	25	3301260S	35	3502116GS	28	3725040GS	30	401256A	66	40580EN	65
3235040S	25	3301280GS	35	3502118GS	28	3725040S	30	401256AD	66	40580EN3	65
3236050GS	26	3301280S	35	3502418GS	28	3726040GS	30	401304A	66	40580T	65
3238030GS	26	3302020GS	35	3502421GS	28	3913060GS	30	401304AD	66	40580T3	65
3238040GS	26	3302525GS	35	3504013GS	27	3915060GS	30	401306A	66	407050E	79
3238040S	26	3305030GS	35	3505025GS	27	3916060GS	30	401306AD	66	407050O	79
3238050GS	26	3305030S	35	3511040GS	29	3921080GS	31	401404A	66	407050T	79
3238050S	26	3305040S	35	3511050GS	29	3921280GS	31	401404AD	66	407075E	79
3238060GS	26	3305050GS	35	3511050S	29	3921540GS	31	401406A	66	407075O	79
3238060S	26	3306030GS	35	3511060GS	29	3922040GS	31	401406AD	66	407075T	79
32414GS	34	3306030S	35	3511210GS	29	3922540GS	31	401504A	66	407100E	79
32415GS	34	3306040S	35	3511240GS	29	3923040GS	31	401504AD	66	407100O	79
32416GS	34	3308030S	35	3511240S	29	3925060GS	31	401506A	66	407100T	79
32418GS	34	3308040S	35	3511250GS	29	3928060GS	31	401506AD	66	407150E	79
32421GS	34	3308050GS	35	3511250S	29	3931080GS	31	401604A	66	407150O	79
32424GS	34	3308050S	35	3511410GS	29	3931280GS	31	401604AD	66	407150T	79
32425GS	34	3308060S	35	3511460GS	29	3931340GS	31	401606A	66	407200E	79
32450GS	34	3314030GS	34	3511460S	29	3931540GS	31	401606AD	66	407200O	79
32480GS	34	3314030S	34	3511480GS	29	3931540S	31	401804A	66	407200T	79
3251410GS	33	331503050GS	34	3511510GS	28	3932040GS	31	401804AD	66	407GG20P	62

See latest catalog or technical data sheets for specific approvals, listings, and design parameters.
 POA = Price on availability. Prices subject to change without notice.

Customer Service: (800) 558-5236

Mechanical Products

Section 15 – Indices



Part No.	Page	Part No.	Page	Part No.	Page	Part No.	Page	Part No.	Page	Part No.	Page	
407GG25P	62	41029	101	41281	102	419124A	67	42115136A	68	42160204A	68	Introduction
407GG30P	62	410304A	66	41282	102	419124AD	67	42115136AD	68	42160204AD	68	
407GG40P	62	410304AD	66	41283	102	419126A	67	42120014AD	68	42160206A	68	
407GG50P	62	410306A	66	41284	102	419126AD	67	42120016A	68	42160206AD	68	Couplings & Fittings
407GG60P	62	410306AD	66	41285	102	419134A	67	42120016AD	68	42160304A	68	
408050E	79	41032	101	41286	102	419134AD	67	42120104A	68	42160304AD	68	
408050T	79	41033	101	41287	102	419136A	67	42120104AD	68	42160306A	68	Mechanical Tees
408075E	79	41034	101	41288	102	419136AD	67	42120134AD	68	42160306AD	68	
408075T	79	41035	101	41289	102	419154A	67	42120136A	68	42160404A	68	
408100E	79	41037	101	41290	102	419154AD	67	42120136AD	68	42160404AD	68	Valves
408100O	79	41038	101	41291	102	419156A	67	42120154A	68	42160406A	68	
408100T	79	41039	101	41292	102	419156AD	67	42120154AD	68	42160406AD	68	
408150E	79	41040	101	41293	102	419204A	67	42120156A	68	42180404A	68	Circuit Balancing Valves
408150T	79	410404A	66	41294	102	419204AD	67	42120156AD	68	42180404AD	68	
408200E	79	410404AD	66	41295	102	419206A	67	42125014AD	68	42180406A	68	
408200T	79	410406A	66	41296	102	419206AD	67	42125016AD	68	42180406AD	68	Accessories
408200E	79	410406AD	66	41297	102	419254A	67	42125016AD	68	42180604A	68	
408200O	79	41041	101	41298	102	419254AD	67	42125104A	68	42180604AD	68	
408200T	79	41047	63	41299	102	419256A	67	42125154A	68	42180606A	68	Copper Systems
40EN3	95	41047	101	41455	63	419256AD	67	42125154AD	68	42180606AD	68	
40EPDME	88	41048	101	41456	63	419304A	67	42125156A	68	441204	68	
40EPDME3	88	41049	101	41457	63	419304AD	67	42125156AD	68	441206	68	Stainless Steel Systems
40FLUORO	89	410504A	66	41458	63	419306A	67	42125204A	68	441254	68	
40FLUORO3	90	410504AD	66	41459	63	419306AD	67	42125204AD	68	441256	68	
40NITRILS	88	410506A	66	41460	63	419404A	67	42125206AD	68	441304	68	Plain End Systems
40NITRILS3	88	410506AD	66	41461	63	419404AD	67	42125206AD	68	441306	68	
40SILICONE	89	410604A	66	41462	63	419406A	67	42130014A	68	441404	68	
410014A	66	410604AD	66	41464	63	419406AD	67	42130014AD	68	441406	68	HDPE Systems
410014AD	66	410606A	66	41465	62	419504A	67	42130016A	68	441604	68	
410016A	66	410606AD	66	41466	62	419504AD	67	42130016AD	68	441606	68	
410016AD	66	410804A	66	41467	62	419506A	67	42130134A	68	441804	68	Gaskets & Spare Parts
410104A	66	410804AD	66	41468	62	419506AD	67	42130134AD	68	441806	68	
410104AD	66	410806A	66	41469	62	419604A	67	42130136A	68	442050E	81	
410106A	66	410806AD	66	41470	62	419604AD	67	42130136AD	68	442050O	81	Preparation Equipment
410106AD	66	41210	101	41472	62	419606A	67	42130154A	68	442050T	81	
410124A	66	41250	101	41500	102	419606AD	67	42130154AD	68	442075E	81	
410124AD	66	41251	101	41501	102	419804A	67	42130156A	68	442075O	81	Miscellaneous
410126A	66	41252	101	41502	102	419804AD	67	42130156AD	68	442075T	81	
410126AD	66	41257	101	41503	102	419806A	67	42130204A	68	442100E	81	
41013	101	41258	101	41504	102	419806AD	67	42130204AD	68	442100O	81	Indices
410134A	66	41259	101	41505	102	42110604A	68	42130206A	68	442100T	81	
410134AD	66	41260	101	41506	102	42110604AD	68	42130206AD	68	442150E	81	
410136A	66	41261	101	41507	102	42110606A	68	42130254A	68	442150O	81	
410136AD	66	41262	102	41508	102	42110606AD	68	42130254AD	68	442150T	81	
41014	101	41263	102	41509	102	42110804A	68	42130256A	68	442200E	81	
41015	101	41264	102	41510	102	42110804AD	68	42130256AD	68	442200O	81	
410154A	66	41265	102	41510	102	42110806A	68	42140204A	68	442200T	81	
410154AD	66	41266	102	41510	102	42110806AD	68	42140204AD	68	45010404A	69	
410156A	66	41267	102	41510	102	42112104A	68	42140206A	68	45010404AD	69	
410156AD	66	41268	102	41510	102	42112104AD	68	42140206AD	68	45010406A	69	
41017	101	41269	102	41511	102	42112106A	68	42140254A	68	45010406AD	69	
41018	101	41270	102	41512	101	42112106AD	68	42140254AD	68	45010604A	69	
410204A	66	41271	102	41513	102	42112804A	68	42140256A	68	45010604AD	69	
410204AD	66	41272	102	41514	102	42112804AD	68	42140256AD	68	45010606A	69	
410206A	66	41273	102	419014A	67	42112806A	68	42140304A	68	45010606AD	69	
410206AD	66	41274	102	419014AD	67	42112806AD	68	42140304AD	68	45010804A	69	
410254A	66	41275	102	419016A	67	42115014A	68	42140306A	68	45010804AD	69	
410254AD	66	41276	102	419016AD	67	42115014AD	68	42140306AD	68	45010806A	69	
410256A	66	41277	102	419104A	67	42115016A	68	42160154A	68	45010806AD	69	
410256AD	66	41278	102	419104AD	67	42115016AD	68	42160154AD	68	45012104A	69	
41027	101	41279	102	419106A	67	42115134A	68	42160156A	68	45012104AD	69	
		41280	102	419106AD	67	42115134AD	68	42160156AD	68	45012106A	69	

Customer Service: (800) 558-5236

See latest catalog or technical data sheets for specific approvals, listings, and design parameters.

POA = Price on availability. Prices subject to change without notice.

Part No.	Page	Part No.	Page	Part No.	Page	Part No.	Page	Part No.	Page	Part No.	Page
45012106AD ...	69	45040254AD ...	69	45112804A ...	70	45150404AD ...	70	460306A ...	67	467200O ...	80
45012604A ...	69	45040256A ...	69	45112804AD ...	70	45150406A ...	70	460306AD ...	67	467200T ...	80
45012604AD ...	69	45040256AD ...	69	45112806A ...	70	45150406AD ...	70	460404A ...	67	468050E ...	79
45012606A ...	69	45040304A ...	69	45112806AD ...	70	45160204A ...	70	460404AD ...	67	468050O ...	79
45012606AD ...	69	45040304AD ...	69	45113014A ...	70	45160204AD ...	70	460406A ...	67	468050T ...	79
45012804A ...	69	45040306A ...	69	45113014AD ...	70	45160206A ...	70	460406AD ...	67	468075E ...	79
45012804AD ...	69	45040306AD ...	69	45113016A ...	70	45160206AD ...	70	460504A ...	67	468075O ...	79
45012806A ...	69	45050304A ...	69	45113016AD ...	70	45160254A ...	70	460504AD ...	67	468075T ...	79
45012806AD ...	69	45050304AD ...	69	45115014A ...	70	45160254AD ...	70	460506A ...	67	468100E ...	79
45015014AD ...	69	45050306A ...	69	45115014AD ...	70	45160256A ...	70	460506AD ...	67	468100O ...	79
45015016A ...	69	45050306AD ...	69	45115016A ...	70	45160256AD ...	70	460604A ...	67	468100T ...	79
45015016AD ...	69	45050404A ...	69	45115016AD ...	70	45160304A ...	70	460604AD ...	67	468150E ...	79
45015134A ...	69	45050404AD ...	69	45115134A ...	70	45160304AD ...	70	460606A ...	67	468150O ...	79
45015134AD ...	69	45050406A ...	69	45115134AD ...	70	45160306A ...	70	460606AD ...	67	468150T ...	79
45015136A ...	69	45050406AD ...	69	45115136A ...	70	45160306AD ...	70	460804A ...	67	468200E ...	79
45015136AD ...	69	45060204A ...	69	45115136AD ...	70	45160404A ...	70	460804AD ...	67	468200O ...	79
45020014AD ...	69	45060204AD ...	69	45120014A ...	70	45160404AD ...	70	460806A ...	67	468200T ...	79
45020016A ...	69	45060206A ...	69	45120014AD ...	70	45160406A ...	70	460806AD ...	67	469050E ...	85
45020016AD ...	69	45060206AD ...	69	45120016A ...	70	45160406AD ...	70	461050E ...	84	469050O ...	85
45020104A ...	69	45060254A ...	69	45120016AD ...	70	45180304A ...	70	461050O ...	84	469050T ...	85
45020134A ...	69	45060254AD ...	69	45120134A ...	70	45180304AD ...	70	461050T ...	84	469075E ...	85
45020134AD ...	69	45060256A ...	69	45120134AD ...	70	45180306A ...	70	461075E ...	84	469075O ...	85
45020136A ...	69	45060256AD ...	69	45120136A ...	70	45180306AD ...	70	461075O ...	84	469075T ...	85
45020136AD ...	69	45060304A ...	69	45120136AD ...	70	45180404A ...	70	461075T ...	84	469100E ...	85
45020154A ...	69	45060304AD ...	69	45120154A ...	70	45180404AD ...	70	461100E ...	84	469100O ...	85
45020154AD ...	69	45060306A ...	69	45120154AD ...	70	45180406A ...	70	461100O ...	84	469100T ...	85
45020156A ...	69	45060306AD ...	69	45120156A ...	70	45180406AD ...	70	461100T ...	84	469150E ...	85
45020156AD ...	69	45060404A ...	69	45120156AD ...	70	45180604A ...	70	461150E ...	84	469150O ...	85
45025154A ...	69	45060404AD ...	69	45125204A ...	70	45180604AD ...	70	461150O ...	84	469150T ...	85
45025154AD ...	69	45060406A ...	69	45125204AD ...	70	45180606A ...	70	461150T ...	84	469200E ...	85
45025156A ...	69	45060406AD ...	69	45125206A ...	70	45180606AD ...	70	461200E ...	84	469200O ...	85
45025156AD ...	69	45060504A ...	69	45125206AD ...	70	460014A ...	67	461200O ...	84	469200T ...	85
45025204A ...	69	45060504AD ...	69	45130014A ...	70	460014AD ...	67	461200T ...	84	470050E ...	80
45025204AD ...	69	45080304A ...	69	45130014AD ...	70	460016A ...	67	466050E ...	85	470050O ...	80
45025206A ...	69	45080304AD ...	69	45130016A ...	70	460016AD ...	67	466050O ...	85	470050T ...	80
45025206AD ...	69	45080306A ...	69	45130016AD ...	70	460104A ...	67	466050T ...	85	470075E ...	80
45030014A ...	69	45080306AD ...	69	45130204A ...	70	460104AD ...	67	466075E ...	85	470075O ...	80
45030014AD ...	69	45080404A ...	69	45130204AD ...	70	460106A ...	67	466075O ...	85	470075T ...	80
45030016A ...	69	45080404AD ...	69	45130206A ...	70	460106AD ...	67	466075T ...	85	470100E ...	80
45030016AD ...	69	45080406A ...	69	45130206AD ...	70	460124A ...	67	466100E ...	85	470100O ...	80
45030134A ...	69	45080406AD ...	69	45130254A ...	70	460124AD ...	67	466100O ...	85	470100T ...	80
45030134AD ...	69	45080604A ...	69	45130254AD ...	70	460126A ...	67	466100T ...	85	470150E ...	80
45030136A ...	69	45080604AD ...	69	45130256A ...	70	460126AD ...	67	466150E ...	85	470150O ...	80
45030136AD ...	69	45080606A ...	69	45130256AD ...	70	460134A ...	67	466150O ...	85	470150T ...	80
45030154A ...	69	45080606AD ...	69	45140204A ...	70	460134AD ...	67	466150T ...	85	470200E ...	80
45030154AD ...	69	45110604A ...	70	45140204AD ...	70	460136A ...	67	466200E ...	85	470200O ...	80
45030156A ...	69	45110604AD ...	70	45140206A ...	70	460136AD ...	67	466200O ...	85	470200T ...	80
45030156AD ...	69	45110606A ...	70	45140206AD ...	70	460154A ...	67	466200T ...	85	471050E ...	80
45030204A ...	69	45110606AD ...	70	45140254A ...	70	460154AD ...	67	467050E ...	80	471050O ...	80
45030204AD ...	69	45110804A ...	70	45140254AD ...	70	460156A ...	67	467050O ...	80	471050T ...	80
45030206A ...	69	45110804AD ...	70	45140256A ...	70	460156AD ...	67	467050T ...	80	471075E ...	80
45030206AD ...	69	45110806A ...	70	45140256AD ...	70	460204A ...	67	467075E ...	80	471075O ...	80
45030254A ...	69	45110806AD ...	70	45140304A ...	70	460204AD ...	67	467075O ...	80	471075T ...	80
45030254AD ...	69	45112104A ...	70	45140304AD ...	70	460206A ...	67	467075T ...	80	471100E ...	80
45030256A ...	69	45112104AD ...	70	45140306A ...	70	460206AD ...	67	467100E ...	80	471100O ...	80
45030256AD ...	69	45112106A ...	70	45140306AD ...	70	460254A ...	67	467100O ...	80	471100T ...	80
45040204A ...	69	45112106AD ...	70	45150304A ...	70	460254AD ...	67	467100T ...	80	471150E ...	80
45040204AD ...	69	45112604A ...	70	45150304AD ...	70	460256A ...	67	467150E ...	80	471150O ...	80
45040206A ...	69	45112604AD ...	70	45150306A ...	70	460256AD ...	67	467150O ...	80	471150T ...	80
45040206AD ...	69	45112606A ...	70	45150306AD ...	70	460304A ...	67	467150T ...	80	471200E ...	80
45040254A ...	69	45112606AD ...	70	45150404A ...	70	460304AD ...	67	467200E ...	80	471200O ...	80

See latest catalog or technical data sheets for specific approvals, listings, and design parameters.
POA = Price on availability. Prices subject to change without notice.

Customer Service: (800) 558-5236

Mechanical Products

Section 15 – Indices



Part No.	Page	Part No.	Page	Part No.	Page	Part No.	Page	Part No.	Page	Part No.	Page
471200T	80	4732005O	81	4760505T	83	4781010T	82	4791015E	83	485100O	84
47210EN	64	4732005T	81	4760510E	83	4781012E	82	4791015O	83	485100T	84
47210EN3	64	4732010E	81	4760510O	83	4781012O	82	4791015T	83	485150E	84
47210T	64	4732010O	81	4760510T	83	4781012T	82	4791075E	83	485150O	84
47210T3	64	4732010T	81	4760575E	83	4781015E	82	4791075O	83	485150T	84
47212EN	64	4732015E	81	4760575O	83	4781015O	82	4791075T	83	485200E	84
47212EN3	64	4732015O	81	4760575T	83	4781015T	82	4791510E	83	485200O	84
47212T	64	4732015T	81	4761010E	83	4781075E	82	4791510O	83	485200T	84
47212T3	64	4732075E	81	4761010O	83	4781075O	82	4791510T	83	50240P	99
47213EN	64	4732075O	81	4761010T	83	4781075T	82	4791512E	83	50241P	99
47213EN3	64	4732075T	81	4761012E	83	4781505E	82	4791512O	83	50242P	99
47213T	64	4737505E	81	4761012O	83	4781505O	82	4791512T	83	50243P	99
47213T3	64	4737505O	81	4761012T	83	4781505T	82	4791515E	83	50244P	99
47215EN	64	4737505T	81	4761015E	83	4781510E	82	4791515O	83	50245P	99
47215EN3	64	4741005E	82	4761015O	83	4781510O	82	4791515T	83	50246P	99
47215T	64	4741005O	82	4761015T	83	4781510T	82	4791520E	83	50247P	99
47215T3	64	4741005T	82	4761075E	83	4781515E	82	4791520O	83	50248P	99
47220EN	64	4741075E	82	4761075O	83	4781515O	82	4791520T	83	5025	49
47220EN3	64	4741075O	82	4761075T	83	4781515T	82	4792012E	83	5026	49
47220T	64	4741075T	82	4761510E	83	4781575E	82	4792012O	83	5027	49
47220T3	64	4741505E	82	4761510O	83	4781575O	82	4792012T	83	5028	49
47225EN	64	4741505O	82	4761510T	83	4781575T	82	4792015E	83	5029	49
47225EN3	64	4741505T	82	4761512E	83	4782005E	82	4792015O	83	5030	49
47225T	64	4741510E	82	4761512O	83	4782005O	82	4792015T	83	5031	49
47225T3	64	4741510O	82	4761512T	83	4782005T	82	4792020E	83	5032	49
47230EN	64	4741510T	82	4761515E	83	4782010E	82	4792020O	83	5033	49
47230EN3	64	4741575E	82	4761515O	83	4782010O	82	4792020T	83	5034	49
47230T	64	4741575O	82	4761515T	83	4782010T	82	4797505E	83	5035	49
47230T3	64	4741575T	82	4761575E	83	4782020E	82	4797505O	83	5036	49
47240EN	64	4742005E	82	4761575O	83	4782020O	82	4797505T	83	5037	49
47240EN3	64	4742005O	82	4761575T	83	4782020T	82	4797510E	83	5038	49
47240T	64	4742005T	82	4762015E	83	4782075E	82	4797510O	83	5039	49
47240T3	64	4742010E	82	4762015O	83	4782075O	82	4797510T	83	5040	49
47250EN	64	4742010O	82	4762015T	83	4782075T	82	4797512E	83	5040EPDME	91
47250EN3	64	4742010T	82	4762020E	83	4787505E	82	4797512O	83	5040NITRILS	91
47250T	64	4742015E	82	4762020O	83	4787505O	82	4797512T	83	5041A	49
47250T3	64	4742015O	82	4762020T	83	4787505T	82	4797575E	83	50EN3	95
47260EN	64	4742015T	82	4767505E	83	4787510E	82	4797575O	83	50EPDME	88
47260EN3	64	4742075E	82	4767505O	83	4787510O	82	4797575T	83	50EPDME3	88
47260T	64	4742075O	82	4767505T	83	4787510T	82	484050E	84	50FLUORO	89
47260T3	64	4742075T	82	4767510E	83	4787575E	82	484050O	84	50FLUORO3	90
47280EN	64	4747505E	82	4767510O	83	4787575O	82	484050T	84	50NITRILS	88
47280EN3	64	4747505O	82	4767510T	83	4787575T	82	484075E	84	50NITRILS3	88
47280T	64	4747505T	82	4767512E	83	4790505E	83	484075O	84	50SILICONE	89
47280T3	64	475050E	85	4767512O	83	4790505O	83	484075T	84	590300100	51
4731005E	81	475050O	85	4767512T	83	4790505T	83	484100E	84	590300100P	51
4731005O	81	475050T	85	4767575E	83	4790510E	83	484100O	84	590300100TP	51
4731005T	81	475075E	85	4767575O	83	4790510O	83	484100T	84	590300120P	51
4731075E	81	475075O	85	4767575T	83	4790510T	83	484150E	84	590300120TP	51
4731075O	81	475075T	85	477075	84	4790575E	83	484150O	84	59030020	51
4731075T	81	475100E	85	477100	84	4790575O	83	484150T	84	59030020P	51
4731505E	81	475100O	85	477150	84	4790575T	83	484200E	84	59030020TP	51
4731505O	81	475100T	85	477200	84	4791005E	83	484200O	84	59030020TP	51
4731505T	81	475150E	85	4780505E	82	4791005O	83	484200T	84	59030025	51
4731510E	81	475150O	85	4780505O	82	4791005T	83	485050E	84	59030025P	51
4731510O	81	475150T	85	4780505T	82	4791010E	83	485050O	84	59030025TP	51
4731510T	81	475200E	85	4780575E	82	4791010O	83	485050T	84	59030030	51
4731575E	81	475200O	85	4780575O	82	4791010T	83	485075E	84	59030030P	51
4731575O	81	475200T	85	4780575T	82	4791012E	83	485075O	84	59030030TP	51
4731575T	81	4760505E	83	4781010E	82	4791012O	83	485075T	84	59030040	51
4732005E	81	4760505O	83	4781010O	82	4791012T	83	485100E	84	59030040P	51

Introduction
Couplings & Fittings
Mechanical Tees
Valves
Circuit Balancing Valves
Accessories
Copper Systems
Stainless Steel Systems
Plain End Systems
Stainless Steel G-PRESS
HDPE Systems
Gaskets & Spare Parts
Preparation Equipment
Miscellaneous
Indices

Customer Service: (800) 558-5236

www.grinnell.com

See latest catalog or technical data sheets for specific approvals, listings, and design parameters.
POA = Price on availability. Prices subject to change without notice.

Part No.	Page	Part No.	Page	Part No.	Page	Part No.	Page	Part No.	Page	Part No.	Page
59030040T	51	61725NSF	96	64040EHT	58	7021501NITRILS	94	7024075EPDME	94	70520EGS	9
59030040TP	51	61730ENP	59	64050EHT	58	7021505EPDME	94	7024075FES	13	70520ES	9
59030050	51	61730NSF	96	64060EHT	58	7021505FES	13	7024075NITRILS	94	70520LGS	10
59030050P	51	61740ENP	59	64080EHT	58	7021505NITRILS	94	7026001EPDME	94	70520LS	10
59030050TP	51	61740NSF	96	64520S	60	7021575EPDME	94	7026001FES	13	70520OS	10
59030060	51	61820075	62	64525S	60	7021575FES	13	7026001NITRILS	94	70520T3GS	9
59030060P	51	6182010	62	64530S	60	7021575NITRILS	94	7026015EPDME	94	70520T3S	9
59030060T	51	6182013	62	64540S	60	7022001EPDME	94	7026015FES	13	70520TGS	9
59030060TP	51	6182015	62	64550S	60	7022001FES	13	7026015GRVES	14	70520TS	9
59030080	51	61825075	62	64560S	60	7022001GRVES	14	7026015MES	14	70525E3GS	9
59030080P	51	6182510	62	64580S	60	7022001MES	14	7026015NITRILS	94	70525E3S	9
59030080T	51	6182513	62	6502520	61	7022001NITRILS	94	7026020EPDME	94	70525EGS	9
59030080TP	51	6182515	62	6503020	61	7022005EPDME	94	7026020GRVES	14	70525ES	9
6040EPDME	91	61830075	62	6503025	61	7022005FES	13	7026020MES	14	70525LGS	10
6040NITRILS	91	6183010	62	6504020	61	7022005NITRILS	94	7026020NITRILS	94	70525LS	10
6050EPDME	91	6183013	62	6504025	61	7022075EPDME	94	70510E3GS	9	70525OS	10
6050NITRILS	91	6183015	62	6504030	61	7022075FES	13	70510E3S	9	70525T3GS	9
60EN3	95	61840075	62	6505030	61	7022075NITRILS	94	70510EGS	9	70525T3S	9
60EPDME	88	6184010	62	6505040	61	7022501EPDME	94	70510ES	9	70525TGS	9
60EPDME3	88	6184013	62	6506030	61	7022501FES	13	70510LGS	10	70525TS	9
60FLUORO	89	6184015	62	6506040	61	7022501NITRILS	94	70510LS	10	70530E3GS	9
60FLUORO3	90	61920S	60	6506050	61	7022505EPDME	94	70510OS	10	70530E3S	9
60NITRILS	88	61925S	60	6508060	61	7022505FES	13	70510T3GS	9	70530EGS	9
60NITRILS3	88	61930S	60	6522010W	61	7022505NITRILS	94	70510T3S	9	70530ES	9
60SILICONE	89	61940S	60	6522013W	61	7022513EPDME	94	70510TGS	9	70530LGS	10
61020S	60	61950S	60	6522015W	61	7022513GRVES	14	70510TS	9	70530LS	10
61025S	60	61960S	60	6522510W	61	7022513MES	14	70512E3GS	9	70530OS	10
61030S	60	61980S	60	6522513W	61	7022513NITRILS	94	70512E3S	9	70530T3GS	9
61040S	60	61H20ENP	59	6522515W	61	7022515EPDME	94	70512EGS	9	70530T3S	9
61050S	60	61H20NSF	96	6522520W	61	7022515GRVES	14	70512ES	9	70530TGS	9
61060S	60	61H25ENP	59	6523015W	61	7022515MES	14	70512LGS	10	70530TS	9
61080S	60	61H25NSF	96	6523020W	61	7022575EPDME	94	70512LS	10	70540E3GS	9
6120EN	59	61H30ENP	59	6524020W	61	7022575FES	13	70512OS	10	70540E3S	9
6120NSF	96	61H30NSF	96	66020S	60	7022575NITRILS	94	70512T3GS	9	70540EGS	9
6125EN	59	61H40ENP	59	66025S	60	7023001EPDME	94	70512T3S	9	70540ES	9
6125NSF	96	61H40NSF	96	66030S	60	7023001FES	13	70512TGS	9	70540LGS	10
6130EN	59	61H50ENP	59	66040S	60	7023001GRVES	14	70512TS	9	70540LS	10
6130NSF	96	61H50NSF	96	66050S	60	7023001MES	14	70513E3GS	9	70540OS	10
6140EN	59	61H60ENP	59	66060S	60	7023001NITRILS	94	70513E3S	9	70540T3GS	9
6140NSF	96	61H60NSF	96	66080S	60	7023013EPDME	94	70513EGS	9	70540T3S	9
6150EN	59	61PW20	97	67220EN3	58	7023013NITRILS	94	70513ES	9	70540TGS	9
6150NSF	96	61PW25	97	67225EN3	58	7023015EPDME	94	70513LGS	10	70540TS	9
6160EN	59	61PW30	97	67230EN3	58	7023015GRVES	14	70513LS	10	70550E3GS	9
6160NSF	96	61PW40	97	67240EN3	58	7023015MES	14	70513OS	10	70550E3S	9
6162520ENP	58	61PW50	97	67250EN3	58	7023015NITRILS	94	70513T3GS	9	70550EGS	9
6162520NSF	95	61PW60	97	67260EN3	58	7023075EPDME	94	70513T3S	9	70550ES	9
6163020ENP	58	6212520	61	67280EN3	58	7023075FES	13	70513TGS	9	70550LGS	10
6163020NSF	95	6213020	61	68020EG	63	7023075NITRILS	94	70513TS	9	70550LS	10
6163025ENP	58	6213025	61	68020EL	63	7024001EPDME	94	70515E3GS	9	70550OS	10
6163025NSF	95	6214020	61	68025EG	63	7024001FES	13	70515E3S	9	70550T3GS	9
6164025ENP	58	6214025	61	68025EL	63	7024001MES	14	70515EGS	9	70550T3S	9
6164025NSF	95	6214030	61	68030EG	63	7024001NITRILS	94	70515ES	9	70550TGS	9
6164030ENP	58	6215030	61	68030EL	63	7024015EPDME	94	70515LGS	10	70550TS	9
6164030NSF	95	6215040	61	68040EG	63	7024015FES	13	70515LS	10	70560E3GS	9
6165040ENP	58	6216025	61	68040EL	63	7024015GRVES	14	70515OS	10	70560E3S	9
6165040NSF	95	6216030	61	68050EG	63	7024015MES	14	70515T3GS	9	70560EGS	9
6166040ENP	58	6216040	61	68050EL	63	7024015NITRILS	94	70515T3S	9	70560ES	9
6166040NSF	95	6216050	61	68060EG	63	7024020EPDME	94	70515TGS	9	70560LGS	10
61720ENP	59	64020EHT	58	68060EL	63	7024020GRVES	14	70515TS	9	70560LS	10
61720NSF	96	64025EHT	58	7021501EPDME	94	7024020MES	14	70520E3GS	9	70560OS	10
61725ENP	59	64030EHT	58	7021501FES	13	7024020NITRILS	94	70520E3S	9	70560T3GS	9

See latest catalog or technical data sheets for specific approvals, listings, and design parameters.
 POA = Price on availability. Prices subject to change without notice.

Customer Service: (800) 558-5236

www.grinnell.com

Mechanical Products

Section 15 – Indices



Part No.	Page	Part No.	Page	Part No.	Page	Part No.	Page	Part No.	Page	Part No.	Page	
70560T3S.	9	70715TS.	11	70730T3GS.	11	707L36ES.	12	7120TS.	16	7162015TS.	13	Introduction
70560TGS.	9	70716E3GS.	11	70730T3S.	11	707L36TGS.	12	7121EPDME.	92	7162520EGS.	13	
70560TS.	9	70716E3S.	11	70730TGS.	11	707L36TS.	12	7121FWC.	92	7162520ES.	13	Couplings & Fittings
70580E3GS.	9	70716EGS.	11	70730TS.	11	707L40EGS.	12	7121GS.	16	7162520TGS.	13	
70580E3S.	9	70716ES.	11	70740E3GS.	11	707L40ES.	12	7121NITRILS.	92	7162520TS.	13	Mechanical Tees
70580EGS.	9	70716LS.	12	70740E3S.	11	707L40TGS.	12	7121S.	16	7163020EGS.	13	
70580ES.	9	70716OS.	12	70740EGS.	11	707L40TS.	12	7121TGS.	16	7163020ES.	13	Valves
70580LGS.	10	70716T3GS.	11	70740ES.	11	707L42EGS.	12	7121TS.	16	7163020TGS.	13	
70580LS.	10	70716T3S.	11	70740LS.	12	707L42ES.	12	7124EPDME.	92	7163020TS.	13	Circuit Balancing Valves
70580OS.	10	70716TGS.	11	70740OS.	12	707L42TGS.	12	7124FWC.	92	7163025EGS.	13	
70580T3GS.	9	70716TS.	11	70740T3GS.	11	707L42TS.	12	7124GS.	16	7163025ES.	13	Accessories
70580T3S.	9	70718E3GS.	11	70740T3S.	11	7110EPDME.	92	7124NITRILS.	92	7163025TGS.	13	
70580TGS.	9	70718E3S.	11	70740TGS.	11	7110EPDMEP.	92	7124S.	16	7163025TS.	13	Copper Systems
70580TS.	9	70718EGS.	11	70740TS.	11	7110FLUOROP.	92	7124TGS.	16	7164020EGS.	13	
70701E3GS.	11	70718ES.	11	70750E3GS.	11	7110FW.	92	7124TS.	16	7164020ES.	13	Stainless Steel Systems
70701E3S.	11	70718T3GS.	11	70750E3S.	11	7110FWC.	92	7125EPDME.	92	7164020TGS.	13	
70701EGS.	11	70718T3S.	11	70750EGS.	11	7110GS.	16	7125FW.	92	7164020TS.	13	Plain End Systems
70701ES.	11	70718TGS.	11	70750ES.	11	7110NITRILS.	92	7125FWC.	92	7164025EGS.	13	
70701T3GS.	11	70718TS.	11	70750LS.	12	7110NITRILSP.	92	7125GS.	16	7164025ES.	13	Stainless Steel G-PRESS
70701T3S.	11	70720E3GS.	11	70750OS.	12	7110S.	16	7125NITRILS.	92	7164025TGS.	13	
70701TGS.	11	70720E3S.	11	70750T3GS.	11	7110TGS.	16	7125S.	16	7164025TS.	13	HDPE Systems
70701TS.	11	70720EGS.	11	70750T3S.	11	7110TS.	16	7125TGS.	16	7164030EGS.	13	
70710E3GS.	11	70720ES.	11	70750TGS.	11	7112EPDME.	92	7125TS.	16	7164030ES.	13	Gaskets & Spare Parts
70710E3S.	11	70720LS.	12	70750TS.	11	7112EPDMEP.	92	7130EPDME.	92	7164030EES.	13	
70710EGS.	11	70720OS.	12	70760E3GS.	11	7112FLUOROP.	92	7130FW.	92	7164030TGS.	13	Preparation Equipment
70710ES.	11	70720T3GS.	11	70760E3S.	11	7112FW.	92	7130FWC.	92	7165040EGS.	13	
70710LS.	12	70720T3S.	11	70760EGS.	11	7112FWC.	92	7130GS.	16	7165040ES.	13	Miscellaneous
70710OS.	12	70720TGS.	11	70760ES.	11	7112GS.	16	7130NITRILS.	92	7165040TGS.	13	
70710T3GS.	11	70720TS.	11	70760LS.	12	7112NITRILS.	92	7130S.	16	7165040TS.	13	Indices
70710T3S.	11	70721E3GS.	11	70760OS.	12	7112NITRILSP.	92	7130TGS.	16	7166040EGS.	13	
70710TGS.	11	70721E3S.	11	70760T3GS.	11	7112S.	16	7130TS.	16	7166040ES.	13	
70710TS.	11	70721EGS.	11	70760T3S.	11	7112TGS.	16	7140EPDME.	92	7166040EES.	13	
70712E3GS.	11	70721ES.	11	70760TGS.	11	7112TS.	16	7140FW.	92	7166040TS.	13	
70712E3S.	11	70721T3GS.	11	70760TS.	11	7114EPDME.	92	7140FWC.	92	7166050EGS.	13	
70712EGS.	11	70721T3S.	11	70780E3GS.	11	7114FWC.	92	7140GS.	16	7166050ES.	13	
70712ES.	11	70721TGS.	11	70780E3S.	11	7114GS.	16	7140NITRILS.	92	7166050TGS.	13	
70712LS.	12	70721TS.	11	70780EGS.	11	7114NITRILS.	92	7140S.	16	7166050TS.	13	
70712OS.	12	70724E3GS.	11	70780ES.	11	7114S.	16	7140TGS.	16	7168060EGS.	13	
70712T3GS.	11	70724E3S.	11	70780LS.	12	7114TGS.	16	7140TS.	16	7168060ES.	13	
70712TGS.	11	70724EGS.	11	70780OS.	12	7114TS.	16	7150EPDME.	92	7168060TGS.	13	
70712TS.	11	70724ES.	11	70780T3GS.	11	7116EPDME.	92	7150FW.	92	7168060TS.	13	
70714E3GS.	11	70724T3GS.	11	70780T3S.	11	7116FWC.	92	7150FWC.	92	7180EPDME.	92	
70714E3S.	11	70724T3S.	11	70780TGS.	11	7116GS.	16	7150GS.	16	7180EPDMEP.	92	
70714EGS.	11	70724TGS.	11	70780TS.	11	7116NITRILS.	92	7150NITRILS.	92	7180FLUOROP.	92	
70714ES.	11	70724TS.	11	707L26EGS.	12	7116S.	16	7150S.	16	7180FW.	92	
70714LS.	12	70725E3GS.	11	707L26ES.	12	7116TGS.	16	7150TGS.	16	7180FWC.	92	
70714OS.	12	70725E3S.	11	707L26TGS.	12	7116TS.	16	7150TS.	16	7180GS.	16	
70714T3GS.	11	70725EGS.	11	707L26TS.	12	7118EPDME.	92	7160EPDME.	92	7180NITRILS.	92	
70714TGS.	11	70725ES.	11	707L28EGS.	12	7118FWC.	92	7160EPDMEP.	92	7180NITRILSP.	92	
70714TS.	11	70725LS.	12	707L28ES.	12	7118GS.	16	7160FLUOROP.	92	7180S.	16	
70715E3GS.	11	70725OS.	12	707L28TGS.	12	7118NITRILS.	92	7160FW.	92	7180TGS.	16	
70715E3S.	11	70725T3GS.	11	707L28TS.	12	7118S.	16	7160FWC.	92	7180TS.	16	
70715EGS.	11	70725T3S.	11	707L30EGS.	12	7118TGS.	16	7160GS.	16	71H10GS.	15	
70715ES.	11	70725TGS.	11	707L30ES.	12	7118TS.	16	7160NITRILS.	92	71H10OGS.	15	
70715LS.	12	70725TS.	11	707L30TGS.	12	7120EPDME.	92	7160NITRILSP.	92	71H10OS.	15	
70715OS.	12	70730E3GS.	11	707L30TS.	12	7120FW.	92	7160S.	16	71H10S.	15	
70715T3GS.	11	70730E3S.	11	707L32EGS.	12	7120FWC.	92	7160TGS.	16	71H10TGS.	15	
70715TGS.	11	70730EGS.	11	707L32ES.	12	7120GS.	16	7160TS.	16	71H10TS.	15	
		70730ES.	11	707L32TGS.	12	7120NITRILS.	92	7162015EGS.	13	71H12GS.	15	
		70730LS.	12	707L32TS.	12	7120S.	16	7162015ES.	13	71H12OGS.	15	
		70730OS.	12	707L36EGS.	12	7120TGS.	16	7162015TGS.	13	71H12OS.	15	

Customer Service: (800) 558-5236

www.grinnell.com

See latest catalog or technical data sheets for specific approvals, listings, and design parameters.
POA = Price on availability. Prices subject to change without notice.

Part No.	Page	Part No.	Page	Part No.	Page	Part No.	Page	Part No.	Page	Part No.	Page
71H12S	15	72035	35	72889	27	7302013ES	42	7302515EGS	42	7303015TGCS	44
71H12TGS	15	72601	32	72897	28	7302013TCS	44	7302515ERCS	45	7303015TGRCS	45
71H12TS	15	72602	32	72898	28	7302013TGCS	44	7302515ERS	43	7303015TGRS	43
71H20EPDME	92	72603	32	72899	28	7302013TGRCS	45	7302515ES	42	7303015TGS	42
71H20FLUORO	92	72604	32	72900	28	7302013TGRS	43	7302515TCS	44	7303015TRCS	45
71H20GS	15	72605	32	72901	28	7302013TGS	42	7302515TGCS	44	7303015TRS	43
71H20NITRILS	92	72606	32	72902	28	7302013TRCS	45	7302515TGRCS	45	7303015TS	42
71H20OGS	15	72607	32	72903	28	7302013TRS	43	7302515TGRS	43	7303020ECS	44
71H20OS	15	72608	32	72904	28	7302013TS	42	7302515TGS	42	7303020EGCS	44
71H20S	15	72609	32	72906	28	7302015ECS	44	7302515TRCS	45	7303020EGRCS	45
71H20TGS	15	72610	32	72910	28	7302015EGCS	44	7302515TRS	43	7303020EGRS	43
71H20TS	15	72611	32	72911	28	7302015EGRCS	45	7302515TS	42	7303020EGS	42
71H25EPDME	92	72612	32	72915	28	7302015EGRS	43	7302520EGP	42	7303020ERCS	45
71H25FLUORO	92	72613	32	72920	28	7302015EGS	42	7302520EGRP	43	7303020ERS	43
71H25GS	15	72614	32	72921	28	7302015ERCS	45	7302520EP	42	7303020ES	42
71H25NITRILS	92	72620	31	72922	28	7302015ERS	43	7302520ERP	43	7303020TCS	44
71H25OGS	15	72622	31	72923	28	7302015ES	42	7302520TGP	42	7303020TGCS	44
71H25OS	15	72623	31	72924	28	7302015TCS	44	7302520TGRP	43	7303020TGRCS	45
71H25S	15	72645	22	72925	28	7302015TGCS	44	7302520TP	42	7303020TGRS	43
71H25TGS	15	72646	22	72930	28	7302015TGRCS	45	7302520TRP	43	7303020TGS	42
71H25TS	15	72647	22	72931	28	7302015TGRS	43	7303005EGS	42	7303020TRCS	45
71H30EPDME	92	72649	22	72932	28	7302015TGS	42	7303005ES	42	7303020TRS	43
71H30FLUORO	92	72650	22	72933	28	7302015TRCS	45	7303005TGS	42	7303020TS	42
71H30GS	15	72651	22	72939	29	7302015TRS	43	7303005TS	42	7304005EGS	42
71H30NITRILS	92	72652	22	72941	29	7302015TS	42	73030075EGS	42	7304005ES	42
71H30OGS	15	72653	22	72946	29	7302505EGS	42	73030075ES	42	7304005TGS	42
71H30OS	15	72670	22	72947	29	7302505ES	42	73030075TGS	42	7304005TS	42
71H30S	15	72671	22	72948	29	7302505TGS	42	73030075TS	42	73040075EGS	42
71H30TGS	15	72672	22	72949	29	7302505TS	42	7303010ECS	44	73040075ES	42
71H30TS	15	72673	22	72950	29	73025075EGS	42	7303010EGCS	44	73040075TGS	42
71H40EPDME	92	72674	22	72951	29	73025075ES	42	7303010EGS	42	73040075TS	42
71H40FLUORO	92	72675	22	72952	29	73025075TGS	42	7303010ES	42	7304010ECS	44
71H40GS	15	72680	31	72953	29	73025075TS	42	7303010TCS	44	7304010EGCS	44
71H40NITRILS	92	72681	31	72954	29	7302510ECS	44	7303010TGCS	44	7304010EGS	42
71H40OGS	15	72682	31	72955	29	7302510EGCS	44	7303010TGS	42	7304010ES	42
71H40OS	15	72683	31	72956	29	7302510EGS	42	7303010TS	42	7304010TCS	44
71H40S	15	72684	31	72958	29	7302510ES	42	7303013ECS	44	7304010TGCS	44
71H40TGS	15	72685	31	72963	29	7302510TCS	44	7303013EGCS	44	7304010TGS	42
71H40TS	15	72686	31	7302005EGS	42	7302510TGCS	44	7303013EGRCS	45	7304010TS	42
71H50EPDME	92	72687	31	7302005ES	42	7302510TGS	42	7303013EGRS	43	7304013ECS	44
71H50FLUORO	92	72688	31	7302005TGS	42	7302510TS	42	7303013EGS	42	7304013EGCS	44
71H50GS	15	72691	31	7302005TS	42	7302513ECS	44	7303013ERCS	45	7304013EGRCS	45
71H50NITRILS	92	72692	31	73020075EGS	42	7302513EGCS	44	7303013ERS	43	7304013EGRS	43
71H50OGS	15	72693	31	73020075ES	42	7302513EGRCS	45	7303013ES	42	7304013EGS	42
71H50OS	15	72694	31	73020075TGS	42	7302513EGRS	43	7303013TCS	44	7304013ERCS	45
71H50S	15	72695	31	73020075TS	42	7302513EGS	42	7303013TGCS	44	7304013ERS	43
71H50TGS	15	72696	31	7302010ECS	44	7302513ERCS	45	7303013TGRCS	45	7304013ES	42
71H50TS	15	72697	31	7302010EGCS	44	7302513ERS	43	7303013TGRS	43	7304013TCS	44
71H60GS	15	72698	31	7302010EGS	42	7302513ES	42	7303013TGS	42	7304013TGCS	44
71H60OGS	15	72699	31	7302010ES	42	7302513TCS	44	7303013TRCS	45	7304013TGRCS	45
71H60OS	15	72852	27	7302010TCS	44	7302513TGCS	44	7303013TRS	43	7304013TGRS	43
71H60S	15	72853	27	7302010TGCS	44	7302513TGRCS	45	7303013TS	42	7304013TGS	42
71H60TGS	15	72854	27	7302010TGS	42	7302513TGRS	43	7303015ECS	44	7304013TRCS	45
71H60TS	15	72855	27	7302010TS	42	7302513TGS	42	7303015EGCS	44	7304013TRS	43
71H80GS	15	72860	27	7302013ECS	44	7302513TRCS	45	7303015EGRCS	45	7304013TS	42
71H80OGS	15	72861	27	7302013EGCS	44	7302513TRS	43	7303015EGRS	43	7304015ECS	44
71H80OS	15	72867	27	7302013EGRCS	45	7302513TS	42	7303015EGS	42	7304015EGCS	44
71H80S	15	72868	27	7302013EGRS	43	7302515ECS	44	7303015ERCS	45	7304015EGRCS	45
71H80TGS	15	72869	27	7302013EGS	42	7302515EGCS	44	7303015ERS	43	7304015EGRS	43
71H80TS	15	72876	27	7302013ERCS	45	7302515EGRCS	45	7303015ES	42	7304015EGS	42
72032	35	72877	27	7302013ERS	43	7302515EGRS	43	7303015TCS	44	7304015ERCS	45

See latest catalog or technical data sheets for specific approvals, listings, and design parameters.
 POA = Price on availability. Prices subject to change without notice.

Customer Service: (800) 558-5236

www.grinnell.com

Mechanical Products

Section 15 – Indices



Part No.	Page	Part No.	Page	Part No.	Page	Part No.	Page	Part No.	Page	Part No.	Page
7304015ERS	43	7304075TGCS	44	7306013TGP	42	7306030TGCS	44	7308040ERS	43	730TGS-2	93
7304015ES	42	7305015EGP	42	7306013TGRP	43	7306030TGRCS	45	7308040ES	42	730TGS-2	93
7304015TCS	44	7305015EGRP	43	7306013TP	42	7306030TGRS	43	7308040TCS	44	730TGS-2	93
7304015TGCS	44	7305015EP	42	7306013TRP	43	7306030TGS	42	7308040TGCS	44	730TGS-3	93
7304015TGRCS	45	7305015ERP	43	7306015ECS	44	7306030TRCS	45	7308040TGRCS	45	730TGS-3	93
7304015TGRS	43	7305015TGP	42	7306015EGCS	44	7306030TRS	43	7308040TGRS	43	730TGS-3	93
7304015TGS	42	7305015TGRP	43	7306015EGRCS	45	7306030TS	42	7308040TGS	42	730TGS-3	93
7304015TRCS	45	7305015TP	42	7306015EGRS	43	7306040ECS	44	7308040TRCS	45	730TGS-3	93
7304015TRS	43	7305015TRP	43	7306015EGS	42	7306040EGCS	44	7308040TRS	43	730TGS-3	93
7304015TS	42	7305020ECS	44	7306015ERCS	45	7306040EGRCS	45	7308040TS	42	730TGS-3	93
7304020ECS	44	7305020EGCS	44	7306015ERS	43	7306040EGRS	43	730EGS-1	93	730TGS-3	93
7304020EGCS	44	7305020EGRCS	45	7306015ES	42	7306040EGS	42	730EGS-1	93	730TGS-4	93
7304020EGRCS	45	7305020EGRS	43	7306015TCS	44	7306040ERCS	45	730EGS-1	93	730TGS-4	93
7304020EGRS	43	7305020EGS	42	7306015TGCS	44	7306040ERS	43	730EGS-1	93	730TGS-4	93
7304020EGS	42	7305020ERCS	45	7306015TGRCS	45	7306040ES	42	730EGS-1	93	730TGS-4	93
7304020ERCS	45	7305020ERS	43	7306015TGRS	43	7306040TCS	44	730EGS-1	93	730TGS-5	93
7304020ERS	43	7305020ES	42	7306015TGS	42	7306040TGCS	44	730EGS-1	93	730TGS-5	93
7304020ES	42	7305020TCS	44	7306015TRCS	45	7306040TGRCS	45	730EGS-1	93	730TGS-6	93
7304020TCS	44	7305020TGCS	44	7306015TRS	43	7306040TGRS	43	730EGS-1	93	730TGS-6	93
7304020TGCS	44	7305020TGRCS	45	7306015TS	42	7306040TGS	42	730EGS-1	93	730TGS-7	93
7304020TGRCS	45	7305020TGRS	43	7306020ECS	44	7306040TRCS	45	730EGS-1	93	730TGS-7	93
7304020TGRS	43	7305020TGS	42	7306020EGCS	44	7306040TRS	43	730EGS-1	93	730TGS-8	93
7304020TGS	42	7305020TRCS	45	7306020EGRCS	45	7306040TS	42	730EGS-2	93	730TGS-8	93
7304020TRCS	45	7305020TRS	43	7306020EGRS	43	7308025ECS	44	730EGS-2	93	730TGS-9	93
7304020TRS	43	7305020TS	42	7306020EGS	42	7308025EGCS	44	730EGS-2	93	73230	38
7304020TS	42	7305025ECS	44	7306020ERCS	45	7308025EGRCS	45	730EGS-2	93	73231	38
7304025ECS	44	7305025EGCS	44	7306020ERS	43	7308025EGRS	43	730EGS-3	93	73232	38
7304025EGCS	44	7305025EGRCS	45	7306020ES	42	7308025EGS	42	730EGS-3	93	73233	38
7304025EGRCS	45	7305025EGRS	43	7306020TCS	44	7308025ERCS	45	730EGS-3	93	73234	38
7304025EGRS	43	7305025EGS	42	7306020TGCS	44	7308025ERS	43	730EGS-3	93	73235	38
7304025EGS	42	7305025ERCS	45	7306020TGRCS	45	7308025ES	42	730EGS-3	93	73235	38
7304025ERCS	45	7305025ERS	43	7306020TGRS	43	7308025TCS	44	730EGS-3	93	73236	38
7304025ERS	43	7305025ES	42	7306020TGS	42	7308025TGCS	44	730EGS-3	93	73237	38
7304025ES	42	7305025TCS	44	7306020TRCS	45	7308025TGRCS	45	730EGS-3	93	73238	38
7304025TCS	44	7305025TGCS	44	7306020TRS	43	7308025TGRS	43	730EGS-4	93	73239	38
7304025TGCS	44	7305025TGRCS	45	7306020TS	42	7308025TGS	42	730EGS-4	93	73240	38
7304025TGRCS	45	7305025TGRS	43	7306025ECS	44	7308025TRCS	45	730EGS-4	93	73241	38
7304025TGRS	43	7305025TGS	42	7306025EGCS	44	7308025TRS	43	730EGS-4	93	73242	38
7304025TGS	42	7305025TRCS	45	7306025EGRCS	45	7308025TS	42	730EGS-5	93	73243	38
7304025TRCS	45	7305025TRS	43	7306025EGRS	43	7308030ECS	44	730EGS-5	93	73251	38
7304025TRS	43	7305025TS	42	7306025EGS	42	7308030EGCS	44	730EGS-6	93	73252	38
7304025TS	42	7305030ECP	44	7306025ERCS	45	7308030EGRCS	45	730EGS-6	93	73253	38
7304030ECS	44	7305030EGCP	44	7306025ERS	43	7308030EGRS	43	730EGS-7	93	73254	38
7304030EGCS	44	7305030EGP	42	7306025ES	42	7308030EGS	42	730EGS-7	93	73255	38
7304030EGRCS	45	7305030EGRCS	45	7306025TCS	44	7308030ERCS	45	730EGS-8	93	73256	38
7304030EGRS	43	7305030EGRP	43	7306025TGCS	44	7308030ERS	43	730EGS-8	93	73260	38
7304030EGS	42	7305030EP	42	7306025TGRCS	45	7308030ES	42	730EGS-9	93	73261	38
7304030ERCS	45	7305030ERCS	45	7306025TGRS	43	7308030TCS	44	730EGS-9	93	73262	38
7304030ERS	43	7305030ERP	43	7306025TGS	42	7308030TGCS	44	730TGS-1	93	73264	38
7304030ES	42	7305030TCP	44	7306025TRCS	45	7308030TGRCS	45	730TGS-1	93	73393	27
7304030TCS	44	7305030TGCP	44	7306025TRS	43	7308030TGRS	43	730TGS-1	93	73396	27
7304030TGCS	44	7305030TGP	42	7306025TS	42	7308030TGS	42	730TGS-1	93	73399	27
7304030TGRCS	45	7305030TGRCS	45	7306030ECS	44	7308030TRCS	45	730TGS-1	93	73400	27
7304030TGRS	43	7305030TGRP	43	7306030EGCS	44	7308030TRS	43	730TGS-1	93	73402	27
7304030TGS	42	7305030TP	42	7306030EGRCS	45	7308030TS	42	730TGS-1	93	73403	27
7304030TRCS	45	7305030TRCS	45	7306030EGRS	43	7308040ECS	44	730TGS-1	93	73404	27
7304030TRS	43	7305030TRP	43	7306030EGS	42	7308040EGCS	44	730TGS-1	93	73406	27
7304030TS	42	7306013EGP	42	7306030ERCS	45	7308040EGRCS	45	730TGS-1	93	73409	27
7304075ECS	44	7306013EGRP	43	7306030ERS	43	7308040EGRS	43	730TGS-1	93	73410	27
7304075EGCS	44	7306013EP	42	7306030ES	42	7308040EGS	42	730TGS-1	93	73500	18
7304075TCS	44	7306013ERP	43	7306030TCS	44	7308040ERCS	45	730TGS-2	93	73501	18

Introduction	
Couplings & Fittings	
Mechanical Tees	
Valves	
Circuit Balancing Valves	
Accessories	
Copper Systems	
Stainless Steel Systems	
Plain End Systems	
Stainless Steel G-PRESS	
HDPE Systems	
Gaskets & Spare Parts	
Preparation Equipment	
Miscellaneous	
Indices	

Customer Service: (800) 558-5236

www.grinnell.com

See latest catalog or technical data sheets for specific approvals, listings, and design parameters.

POA = Price on availability. Prices subject to change without notice.

Part No.	Page	Part No.	Page	Part No.	Page	Part No.	Page	Part No.	Page	Part No.	Page
73506	18	73659	26	73860	29	73998	35	74233	34	75101	31
73507	18	73691	25	73861	29	74020EGHT	6	74234	34	75102	31
73508	18	73694	26	73875	29	74020EHT	6	74240	38	75103	31
73509	18	73696	26	73877	29	74020EPDME	94	74241	38	75104	31
73510	18	73729	36	73878	29	74020NITRILS	94	74245	38	75105	31
73512	18	73730	36	73883	29	74020TGS	6	74254	38	75106	31
73517	18	73743	36	73884	29	74020TS	6	74259	38	75107	31
73525	18	73749	27	73885	29	74025EGHT	6	74260	38	75108	31
73526	18	73750	27	73887	29	74025EHT	6	74263	38	75121	30
73528	18	73751	28	73888	29	74025EPDME	94	74264	38	75122	30
73542	22	73752	28	73892	29	74025NITRILS	94	74265	38	75123	30
73543	22	73753	28	73893	29	74025TGS	6	74268	38	75124	30
73544	22	73754	28	73897	29	74025TS	6	74276	38	75125	30
73565	23	73761	27	73898	29	74030EGHT	6	74278	38	75126	30
73566	23	73764	27	73899	29	74030EHT	6	74283	38	75129	30
73567	23	73770	28	73913	33	74030EPDME	94	74292	30	75130	30
73572	23	73771	28	73914	33	74030NITRILS	94	74293	30	75131	30
73574	24	73774	28	73915	33	74030TGS	6	74294	30	75132	30
73575	24	73779	28	73916	33	74030TS	6	74295	30	75133	30
73576	24	73784	28	73917	33	74040EGHT	6	74296	30	75148	31
73577	24	73785	28	73918	33	74040EHT	6	74297	30	75150	31
73578	24	73786	28	73919	33	74040EPDME	94	74309	31	75151	31
73579	24	73787	28	73920	33	74040NITRILS	94	74311	31	75152	31
73580	24	73792	30	73921	33	74040TGS	6	74327	33	75153	31
73581	25	73793	30	73922	33	74040TS	6	74328	27	75154	31
73582	25	73797	30	73923	33	74050EGHT	6	74330	31	75155	31
73583	25	73799	30	73924	33	74050EHT	6	74331	31	75156	31
73584	25	73802	30	73925	33	74050EPDME	94	74335	30	75157	31
73585	25	73803	36	73926	33	74050NITRILS	94	74336	30	75158	31
73587	25	73804	36	73927	33	74050TGS	6	74337	30	75309	17
73589	24	73805	36	73928	33	74050TS	6	74338	30	75310	17
73590	24	73806	36	73929	33	74060EGHT	6	74339	31	75311	17
73591	24	73807	36	73930	33	74060EHT	6	74672	33	75312	17
73593	24	73808	36	73931	33	74060EPDME	94	74673	33	75315	17
73594	24	73809	36	73932	33	74060NITRILS	94	74675	33	75323	17
73595	24	73810	36	73933	33	74060TGS	6	74676	33	75324	17
73599	24	73811	36	73935	33	74060TS	6	74677	33	75325	17
73600	24	73812	28	73937	33	74080EGHT	6	74678	33	75326	17
73608	25	73813	28	73949	33	74080EHT	6	74679	33	75327	17
73609	25	73814	28	73950	33	74080EPDME	94	74680	33	75328	17
73610	25	73815	28	73957	35	74080NITRILS	94	74681	33	75408	25
73611	25	73816	28	73962	35	74080TGS	6	74682	33	75409	25
73620	24	73817	28	73969	35	74080TS	6	74683	33	75410	24
73621	24	73818	29	73970	35	74208	34	74684	33	75412	24
73622	24	73819	29	73971	35	74209	34	74685	33	75413	24
73624	24	73820	29	73972	35	74210	34	74686	33	75414	24
73625	24	73823	29	73973	35	74211	34	74687	33	75420	24
73627	24	73825	29	73979	35	74212	34	74688	33	75421	24
73629	24	73830	29	73980	35	74214	34	74689	33	75425	24
73630	24	73831	29	73981	35	74217	34	74690	33	75433	24
73631	24	73832	29	73983	35	74218	34	74691	33	75435	24
73633	24	73833	29	73986	35	74219	34	74692	33	75437	24
73635	25	73836	29	73987	35	74220	34	74700	32	75439	24
73636	25	73837	29	73988	35	74221	34	74701	32	75440	24
73647	25	73838	29	73989	35	74222	34	74702	32	75441	24
73648	25	73840	29	73990	35	74223	34	74703	32	75442	24
73649	25	73841	29	73992	35	74224	34	74704	32	75443	24
73650	25	73842	29	73993	35	74226	34	74705	32	75444	24
73651	25	73843	29	73995	35	74228	34	75098	31	75445	24
73652	25	73846	28	73996	35	74229	34	75099	31	75446	24
73653	25	73851	28	73997	35	74231	34	75100	31	75447	24

See latest catalog or technical data sheets for specific approvals, listings, and design parameters.
POA = Price on availability. Prices subject to change without notice.

Customer Service: (800) 558-5236

www.grinnell.com

Mechanical Products

Section 15 – Indices



Part No.	Page	Part No.	Page	Part No.	Page	Part No.	Page	Part No.	Page	Part No.	Page	
75448	24	7550-1-60	56	7550-15-10G	57	7550-75-13GT	56	75519	26	75746	34	Introduction
75449	24	7550-1-60G	56	7550-15-10GT	57	7550-75-13T	56	75520	25	75752	35	
75450	25	7550-1-60GT	56	7550-15-10T	57	7550-75-14	57	75521	25	75758	35	Couplings & Fittings
75451	25	7550-1-60T	56	7550-15-12	57	7550-75-14G	57	75522	25	75759	35	
75452	25	7550-1-80	56	7550-15-12G	57	7550-75-14GT	57	75523	25	75761	22	Mechanical Tees
75453	25	7550-1-80G	56	7550-15-12GT	57	7550-75-14T	57	75524	25	75762	22	
75454	25	7550-1-80GT	56	7550-15-12T	57	7550-75-15	56	75525	25	75763	22	Valves
75455	25	7550-1-80T	56	7550-15-13	56	7550-75-15G	56	75526	25	75764	22	
75456	25	7550-13-10	57	7550-15-13G	56	7550-75-15GT	56	75527	26	75765	22	Circuit Balancing Valves
75457	25	7550-13-10G	57	7550-15-13GT	56	7550-75-15T	56	75528	26	75766	22	
75458	25	7550-13-10GT	57	7550-15-13T	56	7550-75-16	57	75529	26	75767	22	Accessories
75459	25	7550-13-10T	57	7550-15-14	57	7550-75-16G	57	75534	25	75780	18	
75460	25	7550-13-12	57	7550-15-14G	57	7550-75-16GT	57	75535	25	75781	18	Copper Systems
75461	24	7550-13-12G	57	7550-15-14GT	57	7550-75-16T	57	75541	25	75782	18	
75465	23	7550-13-12GT	57	7550-15-14T	57	7550-75-20	56	75546	25	75783	18	Stainless Steel Systems
75466	23	7550-13-12T	57	7550-15-15	56	7550-75-20G	56	75590	26	75784	18	
75469	25	7550-13-13	56	7550-15-15G	56	7550-75-20GT	56	75670	33	75785	18	Plain End Systems
75470	24	7550-13-13G	56	7550-15-15GT	56	7550-75-20T	56	75671	33	75786	18	
75482	24	7550-13-13GT	56	7550-15-15T	56	7550-75-25	56	75672	33	75787	18	HDPE Systems
75484	24	7550-13-13T	56	7550-15-16	57	7550-75-25G	56	75673	33	75790	18	
75486	24	7550-13-14	57	7550-15-16G	57	7550-75-25GT	56	75674	33	75791	18	Gaskets & Spare Parts
75488	36	7550-13-14G	57	7550-15-16GT	57	7550-75-25T	56	75675	33	75792	18	
75490	23	7550-13-14GT	57	7550-15-16T	57	7550-75-30	56	75676	33	75793	18	Preparation Equipment
75491	23	7550-13-14T	57	7550-15-20	56	7550-75-30G	56	75677	33	75794	18	
75492	23	7550-13-15	56	7550-15-20G	56	7550-75-30GT	56	75678	33	75795	18	Miscellaneous
75493	23	7550-13-15G	56	7550-15-20GT	56	7550-75-30T	56	75679	33	75796	18	
7550-1-10G	57	7550-13-15GT	56	7550-15-20T	56	7550-75-40	56	75680	33	75797	18	Indices
7550-1-10GT	57	7550-13-15T	56	7550-15-25	56	7550-75-40G	56	75681	33	75798	18	
7550-1-10T	57	7550-13-16	57	7550-15-25G	56	7550-75-40GT	56	75682	33	75799	18	
7550-1-12G	57	7550-13-16G	57	7550-15-25GT	56	7550-75-40T	56	75683	33	75825	18	
7550-1-12GT	57	7550-13-16GT	57	7550-15-25T	56	7550-75-50	56	75684	33	75826	18	
7550-1-12T	57	7550-13-16T	57	7550-15-30	56	7550-75-50G	56	75685	33	75827	18	
7550-1-13G	56	7550-13-20	56	7550-15-30G	56	7550-75-50GT	56	75686	33	75829	18	
7550-1-13GT	56	7550-13-20G	56	7550-15-30GT	56	7550-75-50T	56	75687	33	75830	18	
7550-1-13T	56	7550-13-20GT	56	7550-15-30T	56	7550-75-60	56	75688	33	75832	18	
7550-1-14G	57	7550-13-20T	56	7550-15-40	56	7550-75-60G	56	75689	33	75840	36	
7550-1-14GT	57	7550-13-25	56	7550-15-40G	56	7550-75-60GT	56	75690	33	75841	36	
7550-1-14T	57	7550-13-25G	56	7550-15-40GT	56	7550-75-60T	56	75691	33	75842	36	
7550-1-15G	56	7550-13-25GT	56	7550-15-40T	56	7550-75-80	56	75692	33	75843	36	
7550-1-15GT	56	7550-13-25T	56	7550-15-50	56	7550-75-80G	56	75695	33	75845	36	
7550-1-15T	56	7550-13-30	56	7550-15-50G	56	7550-75-80GT	56	75700	32	75846	36	
7550-1-16G	57	7550-13-30G	56	7550-15-50GT	56	7550-75-80T	56	75701	32	75847	36	
7550-1-16GT	57	7550-13-30GT	56	7550-15-50T	56	75500	25	75702	32	75848	36	
7550-1-16T	57	7550-13-30T	56	7550-15-60	56	75501	25	75703	32	75849	36	
7550-1-20G	56	7550-13-40	56	7550-15-60G	56	75502	25	75704	32	75850	36	
7550-1-20GT	56	7550-13-40G	56	7550-15-60GT	56	75503	25	75705	32	75851	36	
7550-1-20T	56	7550-13-40GT	56	7550-15-60T	56	75504	25	75706	32	75852	36	
7550-1-25G	56	7550-13-40T	56	7550-15-80	56	75505	25	75707	32	75853	36	
7550-1-25GT	56	7550-13-50	56	7550-15-80G	56	75506	25	75708	32	75901	34	
7550-1-25T	56	7550-13-50G	56	7550-15-80GT	56	75507	25	75710	32	75902	34	
7550-1-30G	56	7550-13-50GT	56	7550-15-80T	56	75508	25	75711	32	75903	34	
7550-1-30GT	56	7550-13-50T	56	7550-75-10	57	75509	25	75712	32	75904	34	
7550-1-30T	56	7550-13-60	56	7550-75-10G	57	75510	25	75730	35	75905	34	
7550-1-40	56	7550-13-60G	56	7550-75-10GT	57	75511	25	75731	35	75906	34	
7550-1-40G	56	7550-13-60GT	56	7550-75-10T	57	75512	25	75732	35	75907	34	
7550-1-40GT	56	7550-13-60T	56	7550-75-12	57	75513	25	75734	34	75908	34	
7550-1-40T	56	7550-13-80	56	7550-75-12G	57	75514	26	75735	35	75909	34	
7550-1-50	56	7550-13-80G	56	7550-75-12GT	57	75515	26	75736	34	75910	34	
7550-1-50G	56	7550-13-80GT	56	7550-75-12T	57	75516	26	75737	34	75911	34	
7550-1-50GT	56	7550-13-80T	56	7550-75-13	56	75517	26	75738	35	75912	34	
7550-1-50T	56	7550-15-10	57	7550-75-13G	56	75518	26	75742	35	75913	34	

Customer Service: (800) 558-5236

www.grinnell.com

See latest catalog or technical data sheets for specific approvals, listings, and design parameters.
POA = Price on availability. Prices subject to change without notice.

Part No.	Page	Part No.	Page	Part No.	Page	Part No.	Page	Part No.	Page	Part No.	Page
75914	34	76821	30	77011	40	77212E3S	7	77218EGS	7	77230HT3S	7
75915	34	76822	25	77012	40	77212EGS	7	77218ES	7	77230HTGS	7
75916	34	76825	30	77012EGS	14	77212ES	7	77218OGS	8	77230HTS	7
76051	41	76826	30	77012ES	14	77212LGS	8	77218OS	8	77240HE3GS	7
76052	41	76827	30	77012TGS	14	77212LS	8	77218T3GS	7	77240HE3S	7
76053	41	76828	30	77012TS	14	77212OGS	8	77218T3S	7	77240HEGS	7
76054	41	76829	30	77013	40	77212OS	8	77218TGS	7	77240HES	7
76055	41	76830	30	77014	40	77212T3GS	7	77218TS	7	77240HLGS	8
76056	41	76831	30	77015	40	77212T3S	7	77220HE3GS	7	77240HLS	8
76057	41	76832	30	77016	40	77212TGS	7	77220HE3S	7	77240HOGS	8
76058	41	76833	30	77017	40	77212TS	7	77220HEGS	7	77240HOS	8
76059	41	76834	30	77018	40	77213E3GS	7	77220HES	7	77240HT3GS	7
76060	41	76835	30	77019	40	77213E3S	7	77220HLGS	8	77240HT3S	7
76061	41	76836	30	77020EGS	14	77213EGS	7	77220HLS	8	77240HTGS	7
76062	41	76837	30	77020ES	14	77213ES	7	77220HOGS	8	77240HTS	7
76063	41	76838	30	77020TGS	14	77213LGS	8	77220HOS	8	77250E3GS	7
76064	41	76839	30	77020TS	14	77213LS	8	77220HT3GS	7	77250E3S	7
76065	41	76840	39	77021	40	77213OGS	8	77220HT3S	7	77250EGS	7
76066	41	76841	39	77022	40	77213OS	8	77220HTGS	7	77250ES	7
76067	41	76842	39	77023	40	77213T3GS	7	77220HTS	7	77250LGS	8
76068	41	76843	39	77024	40	77213T3S	7	77221E3GS	7	77250LS	8
76069	41	76844	39	77025	40	77213TGS	7	77221E3S	7	77250OGS	8
76071	41	76845	39	77025EGS	14	77213TS	7	77221EGS	7	77250OS	8
76072	41	76846	39	77025ES	14	77214E3GS	7	77221ES	7	77250T3GS	7
76073	41	76847	39	77025TGS	14	77214E3S	7	77221OGS	8	77250T3S	7
76074	41	76848	39	77025TS	14	77214EGS	7	77221OS	8	77250TGS	7
76075	41	76849	39	77026	40	77214ES	7	77221T3GS	7	77250TS	7
76076	41	76850	39	77027	40	77214LGS	8	77221T3S	7	77260E3GS	7
76077	41	76851	39	77028	40	77214LS	8	77221TGS	7	77260E3S	7
76078	41	76852	39	77029	40	77214OGS	8	77221TS	7	77260EGS	7
76079	41	76853	39	77030EGS	14	77214OS	8	77224E3GS	7	77260ES	7
76081	41	76854	39	77030ES	14	77214T3GS	7	77224E3S	7	77260LGS	8
76082	41	76855	39	77030TGS	14	77214T3S	7	77224EGS	7	77260LS	8
76502	25	76856	39	77030TS	14	77214TGS	7	77224ES	7	77260OGS	8
76524	25	76857	39	77031	40	77214TS	7	77224OGS	8	77260OS	8
76541	25	76858	39	77032	40	77215E3GS	7	77224OS	8	77260T3GS	7
76587	28	76860	39	77040EGS	14	77215E3S	7	77224T3GS	7	77260T3S	7
76757	36	76861	39	77040ES	14	77215EGS	7	77224T3S	7	77260TGS	7
76758	36	76862	39	77040TGS	14	77215ES	7	77224TGS	7	77260TS	7
76759	36	76863	39	77040TS	14	77215LGS	8	77224TS	7	77280E3GS	7
76800	30	76864	39	77060EGS	14	77215LS	8	77225HE3GS	7	77280ES	7
76801	30	76865	39	77060ES	14	77215OGS	8	77225HE3S	7	77280EGS	7
76802	30	76866	39	77060TGS	14	77215OS	8	77225HEGS	7	77280ES	7
76803	30	76867	39	77060TS	14	77215T3GS	7	77225HES	7	77280LGS	8
76804	30	76868	39	77080EGS	14	77215T3S	7	77225HLGS	8	77280LS	8
76805	30	76870	39	77080ES	14	77215TGS	7	77225HLS	8	77280OGS	8
76806	30	76871	39	77080TGS	14	77215TS	7	77225HOGS	8	77280OS	8
76807	30	77001	40	77080TS	14	77216E3GS	7	77225HOS	8	77280T3GS	7
76808	30	77002	40	77210E3GS	7	77216E3S	7	77225HT3GS	7	77280T3S	7
76809	30	77003	40	77210E3S	7	77216EGS	7	77225HT3S	7	77280TGS	7
76810	30	77004	40	77210EGS	7	77216ES	7	77225HTGS	7	77280TS	7
76811	30	77005	40	77210ES	7	77216LGS	8	77225HTS	7	77280TS	7
76812	30	77006	40	77210LGS	8	77216LS	8	77225HTS	7	77280TS	7
76813	30	77007	40	77210LS	8	77216OGS	8	77225HTS	7	77280TS	7
76814	30	77008	40	77210OGS	8	77216OS	8	77225HTS	7	77280TS	7
76815	30	77009	40	77210OS	8	77216T3GS	7	77225HTS	7	77280TS	7
76816	30	77010	40	77210T3GS	7	77216T3S	7	77225HTS	7	77280TS	7
76817	30	77010EGS	14	77210T3S	7	77216TGS	7	77225HTS	7	77280TS	7
76818	30	77010ES	14	77210TGS	7	77216TS	7	77225HTS	7	77280TS	7
76819	30	77010TGS	14	77210TS	7	77218E3GS	7	77225HTS	7	77280TS	7
76820	30	77010TS	14	77212E3GS	7	77218E3S	7	77225HTS	7	77280TS	7

See latest catalog or technical data sheets for specific approvals, listings, and design parameters.
 POA = Price on availability. Prices subject to change without notice.

Customer Service: (800) 558-5236

www.grinnell.com

Mechanical Products

Section 15 – Indices



Part No.	Page	Part No.	Page	Part No.	Page	Part No.	Page	Part No.	Page	Part No.	Page
78015GES	15	79011T	72	90920TGS	72	909730ES	87	91920F	74	92720GF	74
78015GTS	15	8060EPDME	91	90920TS	72	909740EPDME	98	91920GF	74	92725F	74
78015NITRILS	91	8060NITRILS	91	90925EGS	72	909740ES	87	91925F	74	92725GF	74
78015TES	15	80EN3	95	90925EPDME	97	909760EPDME	98	91925GF	74	92730F	74
78020EPDME	91	80EPDME	88	90925ES	72	909760ES	87	91930F	74	92730GF	74
78020ES	15	80EPDME3	88	90925NITRILS	97	909780EPDME	98	91930GF	74	92740F	74
78020GES	15	80FLUORO	89	90925TGS	72	909780ES	87	91940F	74	92740GF	74
78020GTS	15	80FLUORO3	90	90925TS	72	90980EGS	72	91940GF	74	92760F	74
78020NITRILS	91	80NITRILS	88	90930EGS	72	90980EPDME	97	91960F	74	92760GF	74
78020TES	15	80NITRILS3	88	90930EPDME	97	90980ES	72	91960GF	74	92780F	74
78025EPDME	91	80SILICONE	89	90930ES	72	90980NITRILS	97	91980F	74	92780GF	74
78025ES	15	90110F	73	90930NITRILS	97	90980TGS	72	91980GF	74	94120F	77
78025GES	15	90110GF	73	90930TGS	72	90980TS	72	9211040F	78	94120GF	77
78025GTS	15	90112F	73	90930TS	72	91010F	73	9211040GF	78	94125F	77
78025NITRILS	91	90112GF	73	90940EGS	72	91010GF	73	9211060F	78	94125GF	77
78025TES	15	90120F	73	90940EPDME	97	91012F	73	9211060GF	78	94130F	77
78030EPDME	91	90120GF	73	90940ES	72	91012GF	73	9211080F	78	94130GF	77
78030ES	15	90120LF	74	90940NITRILS	97	91020F	73	9211080GF	78	94140F	77
78030GES	15	90120LGF	74	90940TGS	72	91020GF	73	9213020F	78	94140GF	77
78030GTS	15	90125F	73	90940TS	72	91020LF	73	9213020GF	78	94160F	77
78030NITRILS	91	90125GF	73	909440EPDME	98	91020LGF	73	9214020F	78	94160GF	77
78030TES	15	90125LF	74	909440ES	86	91025F	73	9214020GF	78	94180F	77
78040EPDME	91	90125LGF	74	909460EPDME	98	91025GF	73	9214025F	78	94180GF	77
78040ES	15	90130F	73	909460ES	86	91025LF	73	9214025GF	78	94220F	78
78040GES	15	90130GF	73	909480EPDME	98	91025LGF	73	9214030F	78	94220GF	78
78040GTS	15	90130LF	74	909480ES	86	91030F	73	9214030GF	78	94225F	78
78040NITRILS	91	90130LGF	74	909510EPDME	98	91030GF	73	9216020F	78	94225GF	78
78040TES	15	90140F	73	909510ES	86	91030LF	73	9216020GF	78	94230F	78
78050EPDME	91	90140GF	73	909512EPDME	98	91030LGF	73	9216030F	78	94230GF	78
78050ES	15	90140LF	74	909512ES	86	91040F	73	9216030GF	78	94240F	78
78050GES	15	90140LGF	74	909514EPDME	98	91040GF	73	9216040F	78	94240GF	78
78050GTS	15	90160F	73	909514ES	86	91040LF	73	9216040GF	78	94260F	78
78050NITRILS	91	90160GF	73	909516EPDME	98	91040LGF	73	9218020F	78	94260GF	78
78050TES	15	90160LF	74	909516ES	86	91060F	73	9218020GF	78	94280F	78
78060EPDME	91	90160LGF	74	909518EPDME	98	91060GF	73	9218030F	78	94280GF	78
78060ES	15	90180F	73	909518ES	86	91060LF	73	9218030GF	78	96010F	75
78060GES	15	90180GF	73	909520EPDME	98	91060LGF	73	9218040F	78	96010GF	75
78060GTS	15	90180LF	74	909520ES	86	91080F	73	9218040GF	78	96012F	75
78060NITRILS	91	90180LGF	74	909521EPDME	98	91080GF	73	9218060F	78	96012GF	75
78060TES	15	90910EGS	72	909521ES	86	91080LF	73	9218060GF	78	96020F	75
78080EPDME	91	90910EPDME	97	909530EPDME	98	91080LGF	73	92410F	75	96020GF	75
78080ES	15	90910ES	72	909530ES	86	91410F	75	92410GF	75	96025F	75
78080GES	15	90910NITRILS	97	909540EPDME	98	91410GF	75	92412F	75	96025GF	75
78080GTS	15	90910TGS	72	909540ES	86	91412F	75	92412GF	75	96030F	75
78080NITRILS	91	90910TS	72	909560EPDME	98	91412GF	75	92420F	75	96030GF	75
78080TES	15	90912EPDME	97	909560ES	86	91420F	75	92420GF	75	96040F	75
79008	72	90912NITRILS	97	909580EPDME	98	91420GF	75	92425F	75	96040GF	75
79008G	72	90914EPDME	97	909580ES	86	91425F	75	92425GF	75	96060F	75
79008GT	72	90914NITRILS	97	90960EGS	72	91425GF	75	92430F	75	96060GF	75
79008T	72	90916EPDME	97	90960EPDME	97	91430F	75	92430GF	75	96080F	75
79009	72	90916NITRILS	97	90960ES	72	91430GF	75	92440F	75	96080GF	75
79009G	72	90918EGS	72	90960NITRILS	97	91440F	75	92440GF	75	964020EN3	95
79009GT	72	90918EPDME	97	90960TGS	72	91440GF	75	92460F	75	964025EN3	95
79009T	72	90918ES	72	90960TS	72	91460F	75	92460GF	75	964030EN3	95
79010	72	90918NITRILS	97	909710EPDME	98	91460GF	75	92480F	75	964040EN3	95
79010G	72	90918TGS	72	909710ES	87	91480F	75	92480GF	75	964050EN3	95
79010GT	72	90918TS	72	909712EPDME	98	91480GF	75	92710F	74	964060EN3	95
79010T	72	90920EGS	72	909712ES	87	91910F	74	92710GF	74	964080EN3	95
79011	72	90920EPDME	97	909720EPDME	98	91910GF	74	92712F	74	99120F	76
79011G	72	90920ES	72	909720ES	87	91912F	74	92712GF	74	99120GF	76
79011GT	72	90920NITRILS	97	909730EPDME	98	91912GF	74	92720F	74	99125F	76

Introduction
Couplings & Fittings
Mechanical Tees
Valves
Circuit Balancing Valves
Accessories
Copper Systems
Stainless Steel Systems
Plain End Systems
Stainless Steel G-PRESS
HDPE Systems
Gaskets & Spare Parts
Preparation Equipment
Miscellaneous
Indices

Customer Service: (800) 558-5236
www.grinnell.com

See latest catalog or technical data sheets for specific approvals, listings, and design parameters.
POA = Price on availability. Prices subject to change without notice.

Part No.	Page	Part No.	Page	Part No.	Page	Part No.	Page	Part No.	Page	Part No.	Page
99125GF	76	9998030F	76	B33318TG	48	CB8002002	52	NB12575	99	S85350	54
99130F	76	9998030GF	76	B33320EG	48	CB8002503	52	NB37225	99	S85350G	54
99130GF	76	9998040F	76	B33320TG	48	CB8002504	52	NB50300	99	S85360	54
99140F	76	9998040GF	76	B33324EG	48	CB8003003	52	NB50358	99	S85360G	54
99140GF	76	9998050F	76	B33324TG	48	CB8003004	52	NB62275	99	S85380	54
99160F	76	9998050GF	76	B4801651EL	71	CB8004003	52	NB62325	99	S85380G	54
99160GF	76	9998060F	76	B4801651TL	71	CB8004004	52	NB62350	99	S85510	54
99180F	76	9998060GF	76	B48020EL	71	CB8005002	52	NB62415	99	S85510G	54
99180GF	76	B30310EG	46	B48020TL	71	CB8005003	52	NB62475	99	S85512	54
99220F	77	B30310GO	46	B48025EL	71	CB8005004	52	NB75425	99	S85512G	54
99220GF	77	B30310TG	46	B48025TL	71	CB8006003	52	NB75475	99	S85520	54
99225F	77	B30312EG	46	B48030EL	71	CB8006004	52	NB87550	99	S85520G	54
99225GF	77	B30312GO	46	B48030TL	71	CB8008003	52	NB87650	99	S85525	54
99230F	77	B30312TG	46	B48040EL	71	CB8008004	52	NBSS10550	99	S85525G	54
99230GF	77	B30320EG	46	B48040TL	71	CBBV025	53	NBSS10650	99	S85530	54
99240F	77	B30320EL	46	B48060EL	71	CBIS010	53	NBSS37225	99	S85530G	54
99240GF	77	B30320GO	46	B48060TL	71	CBIS050	53	NBSS50300	99	S85540	54
99260F	77	B30320LO	46	B480761EL	71	CBIS075	53	NBSS62325	99	S85540G	54
99260GF	77	B30320TG	46	B480761TL	71	CBIS125	53	NBSS62475	99	S85550	54
99280F	77	B30320TL	46	B810120E	50	CBIS150	53	NBSS75475	99	S85550G	54
99280GF	77	B30325EG	46	B810125E	50	CBIS200	53	NBSS87650	99	S85560	54
99320F	77	B30325EL	46	B810130E	50	CBIS250	53	PT1000	100	S85560G	54
99320GF	77	B30325GO	46	B810140E	50	CBIS300	53	S8101010	55	S85580	54
99325F	77	B30325LO	46	B810150E	50	CBIS400	53	S8101060	55	S85580G	54
99325GF	77	B30325TG	46	B810160E	50	CBIS500	53	S8101080	55	TD83010	51
99330F	77	B30325TL	46	B820020	50	CBIS600	53	S8101210	55	TD83012	51
99330GF	77	B30330EG	46	B820030	50	CBMA01	53	S8101212	55	TD83014	51
99340F	77	B30330EL	46	B820040	50	CBMDMC2	53	S8101280	55	TD83020	51
99340GF	77	B30330GO	46	B820060	50	CBSE7560	53	S8101410	55	TD83025	51
99360F	77	B30330LO	46	B820080	50	CBSR100	53	S8101412	55	TD83030	51
99360GF	77	B30330TG	46	BV43515	71	CBTK02	53	S8101414	55	TD83040	51
99380F	77	B30330TL	46	BV43520	71	CBTP02	53	S8101614	55	TD83050	51
99380GF	77	B30340EG	46	BV43525	71	CBTPX80	53	S8103020	55	TD83060	51
9992520F	76	B30340EL	46	BV43530	71	CV89014E	51	S8103025	55	TD83080	51
9992520GF	76	B30340GO	46	BV43540	71	CV89014T	51	S8103030	55		
9993020F	76	B30340LO	46	BV83515	50	CV89016E	51	S8104020	55		
9993020GF	76	B30340TG	46	BV83515G	50	CV89016T	51	S8104025	55		
9993025F	76	B30340TL	46	BV83520	50	CV89018E	51	S8104030	55		
9993025GF	76	B30350EG	46	BV83520G	50	CV89018T	51	S8104040	55		
9994020F	76	B30350EL	46	BV83525	50	CV89020E	51	S8105030	55		
9994020GF	76	B30350GO	46	BV83525G	50	CV89020T	51	S8105040	55		
9994025F	76	B30350LO	46	BV83530	50	CV89024E	51	S8105050	55		
9994025GF	76	B30350TG	46	BV83530G	50	CV89024T	51	S8106030	55		
9994030F	76	B30350TL	46	BV83540G	50	GOH30310	47	S8106040	55		
9994030GF	76	B30360EG	46	BV83540M	50	GOH30312	47	S8106050	55		
9995020F	76	B30360EL	46	BV83560	50	GOH30320	47	S8106060	55		
9995020GF	76	B30360GO	46	BV83560G	50	GOH30325	47	S8108050	55		
9995030F	76	B30360LO	46	CB8000501	52	GOH30330	47	S8108060	55		
9995030GF	76	B30360TG	46	CB8000751	52	GOH30340	47	S8108080	55		
9995040F	76	B30360TL	46	CB8000752	52	GOH30350	47	S85310	54		
9995040GF	76	B30380EG	46	CB8001001	52	GOH30360	47	S85310G	54		
9996020F	76	B30380EL	46	CB8001002	52	GOH30380	47	S85312	54		
9996020GF	76	B30380GO	46	CB8001103	52	LH30320	47	S85312G	54		
9996025F	76	B30380LO	46	CB8001104	52	LH30325	47	S85320	54		
9996025GF	76	B30380TG	46	CB8001203	52	LH30330	47	S85320G	54		
9996030F	76	B30380TL	46	CB8001204	52	LH30340	47	S85325	54		
9996030GF	76	B33314EG	48	CB8001251	52	LH30350	47	S85325G	54		
9996040F	76	B33314TG	48	CB8001252	52	LH30360	47	S85330	54		
9996040GF	76	B33316EG	48	CB8001501	52	LH30380	47	S85330G	54		
9996050F	76	B33316TG	48	CB8001502	52	NB10550	99	S85340	54		
9996050GF	76	B33318EG	48	CB8002001	52	NB10650	99	S85340G	54		

See latest catalog or technical data sheets for specific approvals, listings, and design parameters.
 POA = Price on availability. Prices subject to change without notice.

Customer Service: (800) 558-5236

www.grinnell.com

Mechanical Products Section 167 – Indices



Model No.	Page	Model No.	Page
#61 Flange Adapter.....	59	#327 – Grooved Cross	36
#61H Flange Adapter – Hinged	59	#330 Grooved Tee Wye	35
#71 Flange Adapter Replacement Gasket.....	92	#331 Grooved Reducing Tee Wye	34
#71 Flange Washer Adapter, Carbon Steel or Stainless Steel...92		#341 Groove x Flange – Adapter 150#	38
#71 Grooved Flange Adapter	16	#342 Groove x Flange – Adapter 300#	38
#71 Nut, Bolt, and Gasket Kit	99	#372 Groove x Male Thread – Reducer.	30
#71H Grooved Flange Adapter - Hinged	15	#380 Female Thread Adapter, Groove x Female Pipe Thread ...32	
#71H Hinged Flange Adapter Replacement Gaskets.....	92	#391 Groove x Male Thread – Adapter Nipple	30
#201 Grooved 45° Elbow.....	16	#392 Groove x Groove – Adapter Nipple	31
#201LR and #301LR – Grooved 45° Long Radius Elbow	18	#393 Groove x Beveled – Adapter Nipple	31
#210 Grooved 90° Elbow.....	16	#395 Hose Adapter Nipple, Groove x Hose	31
#210LR and #310LR – Grooved 90° Long Radius Elbow	18	#397 Groove x Groove – Swaged Nipple.....	39
#211 and #311 – Grooved 11-1/4° Elbow.....	17	#398 Groove x Male Thread – Swaged Nipple.....	40
#212 and #312 – Grooved 22-1/2° Elbow.....	17	#399 Groove x Plain – Swaged Nipple	41
#219 and #319 – Grooved Tee	23	#401 45° Elbow, Schedule 10	66
#221 and #321 – Grooved Reducing Tee	24 - 25	#405 Flexible Coupling 316 SS	65
#250 and #350 – Grooved Concentric Reducer.....	27 - 28	#405 Flexible Coupling 316 SS with Tri-Seal Gasket	65
#251 and #351 – Grooved Eccentric Reducer	28 - 29	#407 G-PRESS SS Coupling (Press x Press)	79
#260 and #360 – Grooved Cap	36	#407GG Dielectric Waterway Transition Fitting, Grooved x Grooved	62
#260 Cast – Grooved Cap with 1/2", 3/4", or 1" Tap.....	37	#407GT Dielectric Waterway, Grooved x Thread	62
#301 - 3D, #301 - 5D, #301 - 6D, Long Radius 45° Elbow, Painted.....	20	#407T Dielectric Waterway, Male Thread x Male Thread	63
#303 - 3D, #303 - 5D, #303 - 6D, Long Radius 30° Elbow, Painted.....	20	#408 G-PRESS SS Slip Coupling (Press x Press)	79
#306 - 3D, #306 - 5D, #306 - 6D, Long Radius 60° Elbow, Painted.....	19	#410 90° Elbow, Schedule 10	66
#310 - 3D, #310 - 5D, #310 - 6D Long Radius 90° Elbow, Painted.....	19	#419 Tee, Schedule 10	67
#311 - 3D, #311 - 5D, #311 - 6D, Long Radius 11-1/4° Elbow, Painted.....	21	#421 Reducing Tee, Schedule 10.....	68
#312 - 3D, #312 - 5D, #312 - 6D, Long Radius 22-1/2° Elbow, Painted.....	21	#441 Flange Adapter Nipple 150 lbs, Schedule 10	68
#314 Grooved Lateral	32	#442 G-PRESS SS Equal Tee (Press x Press x Press)	81
#315 Groove x Male Thread – Adapter 90° Elbow	22	#450 Concentric Reducer, Schedule 10	69
#316 Reducing Base Support Elbow, Groove x Flange	22	#451 Eccentric Reducer, Schedule 10.....	70
#320 Groove x Male Thread – Tee	23	#460 Cap, Schedule 10.....	67
#323 Groove x Male Thread – Reducing Tee with Threaded Branch	25 - 26	#461 G-PRESS SS Weld Adaptor (Fitting x Weld)	84
#324 Grooved Wye	34	#466 G-PRESS SS Flange Adapter Van Stone (Press x Flange).....	85
#325 Grooved Reducing Lateral	33	#467 G-PRESS SS 90° Elbow (Press x Fitting)	80
		#468 G-PRESS SS 90° Elbow (Press x Press)	79
		#469 G-PRESS SS Ball Valve (Press x Press)	85
		#470 G-PRESS SS 45° Elbow (Press x Fitting)	80

Introduction
Couplings & Fittings
Mechanical Tees
Valves
Circuit Balancing Valves
Accessories
Copper Systems
Stainless Steel Systems
Plain End Systems
Stainless Steel G-PRESS
HDPE Systems
Gaskets & Spare Parts
Preparation Equipment
Miscellaneous
Indices

Model No.	Page	Model No.	Page
#471 G-PRESS SS 45° Elbow (Press x Press)	80	#707 Heavy-Duty Flexible Coupling with Tri-Seal Gasket	11
#472 Rigid Coupling 316 SS	64	#707L Large Diameter Heavy-Duty Flexible Coupling	12
#472 Rigid Coupling 316 SS with Tri-seal Gasket	64	#716 Reducing Coupling	13
#473 G-PRESS SS Reducing Tee (Press x Press x Press)	81	#730 Mechanical Cross – Grooved	45
#474 G-PRESS SS Reducer (Fitting x Press)	82	#730 Mechanical Cross – Threaded	44
#475 G-PRESS SS Flange Adapter (Press x Flange)	85	#730 Mechanical Tee – Grooved	43
#476 G-PRESS SS Adapter (Press x Male NPT)	83	#730 Mechanical Tee – Threaded	42
#477 G-PRESS SS Transition Nipple (Groove x Fitting)	84	#740 Rapid Installation Pivot-Bolt (GRIP) Rigid Coupling	6
#478 G-PRESS SS Reducing Tee Adapter (Press x Press x Female NPT)	82	#770 High Pressure Rigid Coupling	14
#479 G-PRESS SS (Press x Female NPT)	83	#772 Rigid Coupling	7
#484 G-PRESS SS End Cap (Press)	84	#772 Rigid Coupling with Grade “L” Silicone Gasket	8
#485 G-PRESS SS Union (Press x Press)	84	#772 Rigid Coupling with Grade “O” Fluoroelastomer Gasket	8
#590 Grooved Check Valve, EPDM or Nitrile	51	#772 Rigid Coupling with Tri-Seal Gasket	7
#601 Grooved 45° Elbow	60	#780 Snap Coupling	15
#610 Grooved 90° Elbow	60	#901 Plain End 45° Elbow	73
#616 Reducing Coupling	58	#901LR Plain End Long Radius 45° Elbow	74
#617 Transition Coupling for Joining IPS to Copper Tubing Systems	59	#909 Plain End Coupling	72
#618 Reducing Tee, Grooved x Grooved x Cup	62	#9094 HDPE Flange Coupling	86
#619 Tee	60	#9095 HDPE Coupling	86
#621 Reducing Tee, Grooved x Grooved x Grooved	61	#9097 HDPE Transition Coupling	87
#640 Pivot-Bolt Rigid Couplings Center-Stop Push-On Style Gasket	58	#910 Plain End 90° Elbow	73
#650 Grooved Concentric Reducer	61	#910LR Plain End Long Radius 90° Elbow	73
#652 Grooved Reducer, Grooved x Cup	61	#914 Plain End Lateral	75
#660 Cap	60	#919 Plain End Tee	74
#672 Rigid Couplings	58	#921 Reducing Tee Plain End	78
#702 Outlet Coupling, Female Threaded End	13	#924 Plain End True Wye	75
#702 Outlet Coupling, Grooved End	14	#927 Plain End Cross	74
#702 Outlet Coupling, Male Threaded End	14	#941 Flange Adapter 150 lbs.	77
#705 Flexible Coupling	9	#942 Flange Adapter 300 lbs.	78
#705 Flexible Coupling with Grade “L” Silicone Gasket	10	#960 Plain End Cap (Bull Plug)	75
#705 Flexible Coupling with Grade “O” Fluoroelastomer Gasket	10	#991 Adapter Nipple – Plain x Thread	76
#705 Flexible Coupling with Tri-Seal Gasket	9	#992 Adapter Nipple – Plain x Grooved	77
#707 Heavy-Duty Flexible Coupling	11	#993 Adapter Nipple – Plain x Bevel	77
#707 Heavy-Duty Flexible Coupling with Grade “L” or Grade “O” Gasket	12	#999 Plain End Swaged Nipple	76
		#7550 – Expansion Joint	56 - 57
		#B303 Grooved Butterfly Valve – Accessories	47
		#B303 Grooved Butterfly Valve – EPDM or Nitrile	46

Mechanical Products Section 167 – Indices



Model No.	Page	Model No.	Page
#B303 Grooved Butterfly Valve – Fluoroelastomer.....	46	Pipe Tape Chrome Plated with GRINNELL Logo.....	100
#B333 Grooved Butterfly Valve, EPDM or Nitrile, Gear Operator	48	Replacement Gaskets – For #702 Outlet Coupling.....	94
#B480 Stainless Steel Grooved Butterfly Valve	71	Replacement Gaskets – For #730.....	93
#B680 Copper System Butterfly Valve Grooved, EPDM.....	63	Replacement Gaskets – For 772, 770, 705, 707	88
#B8101 Low Profile Butterfly Valve with Lever Handle	50	Replacement Gaskets – For #61 Flange Adapter	96
#B8200L Grooved Butterfly Valve – EPDM (For PVC Piping Systems).....	50	Replacement Gaskets – For #616 Reducing Coupling.....	95
#BV435 Stainless Steel Grooved Ball Valve (600 psi).....	71	Replacement Gaskets – For #617 Transition Coupling	96
#BV835 Grooved Ball Valve	50	Replacement Gaskets – For #61H Flange Adapter - Hinged	96
#CB800 Circuit Balancing Valves – Accessories.....	53	Replacement Gaskets – For #640 Coupling.....	95
#CB800 Flange x Flange – Circuit Balancing Valve	52	Replacement Gaskets – For #672 Coupling.....	95
#CB800 Groove x Groove – Circuit Balancing Valve	52	Replacement Gaskets – For #740 Pivot-Bolt (GRIP) Rigid Coupling	94
#CB800 Solder x Solder – Circuit Balancing Valve	52	Replacement Gaskets – For #909 Plain End Coupling	97
#CB800 Thread x Thread – Circuit Balancing Valve	52	Replacement Gaskets For # 716 Reducing Coupling.....	91
#CV890 Grooved Dual Disk Check Valve, EPDM or Nitrile	51	Replacement Gaskets For #780 Snap Coupling	91
#S810 Groove x Flange ANSI – Suction Diffuser	55	Replacement Grade “L” Silicone Gasket – For 772, 770, 705, 707.....	89
#S853 Grooved Wye Strainer	54	Replacement Grade “O” Fluoroelastomer Gasket – For 772, 770, 705, 707.....	89
#S855 Grooved Tee – Type Strainer	54	Replacement Tri-Seal Gaskets – For 772, 770, 705, 707	88
#TD830, Triple Duty Valve, Flow Control Type.....	51	Replacement Tri-Seal Gaskets Grade “O” Fluoroelastomer Gasket For #772, #770, #705, #707	90
Accessories.....	101	Roll Groover Mini-Mite 2" – 8" Copper Tube #1039-66	63
Babbitt Valve Chainwheels.....	49	Roll Grooving Machine Selection Chart	101
Copper System Grooved Couplings – Pieces Per Carton/Case.....	105	Roll Selection Chart.....	102
Coupling Nut and Bolt Kit.....	99	Table of Contents.....	2 – 4
Differential Measuring Computer.....	53		
G-PRESS SS O-Rings.....	85		
GRINNELL Gasket Lubricant.....	100		
GRINNELL Gasket Styles, Grades and Recommendations.....	5		
GRINNELL Silicone Gasket Lubricant	100		
Grooved Couplings – Pieces Per Carton/Case.....	103		
Grooved Fittings – Pieces Per Carton/Case	103		
Grooved Fittings – Pieces Per Carton/Case	104		
Grooved Fittings – Pieces Per Carton/Case	105		
HDPE – #9094 Replacement Gaskets “E”	98		
HDPE – #9095 Replacement Gaskets “E”	98		
HDPE – #9097 Replacement Gaskets “E”	98		
Insulation Kits for #CB800 Circuit Balancing Valves.....	53		
Phenolic Washer – For #61 Flange Adapter.....	97		

Introduction
Couplings & Fittings
Mechanical Tees
Valves
Circuit Balancing Valves
Accessories
Copper Systems
Stainless Steel Systems
Plain End Systems
Stainless Steel G-PRESS
HDPE Systems
Gaskets & Spare Parts
Preparation Equipment
Miscellaneous
Indices

**Global Strength.
Local Expertise.
At your service.**



North America Headquarters

United States of America

1400 Pennbrook Parkway
Lansdale, PA 19446
Tel: +800 558 5236
Fax: +800 877 1295

United States of America

1802 S.W. 2nd Street
Pompano Beach, FL 33069
Tel: +954 781 0866
Fax: +954 781 9330

Mexico

Av. Presidente Juarez 2007 Lote 6
San Jeronimo Tepetlaco,
Tlalnepantla, Estado de México
Mexico 54090
Tel: +525 55 321 2350
Fax: +525 55 321 2358

Singapore

2 Serangoon North Avenue 5
#07-01
Singapore 554911
Tel: +65 6577 4360
Fax: +65 6481 8791
Email: info.apac@tycofp.com

Australia

Level 3, 95 Coventry Street
Southbank, VIC 3006
Australia
Tel: +1 300 725 688 (Local)
Fax: +1 300 720 733
Tel: +61 3 9313 9700 (Int'l)
Fax: +61 3 9313 9709
Email: info.aust@tycofp.com

The Netherlands

Kopersteden 1
P.O. Box 198
7500 AD Enschede
Tel: +31 0 53 428 4444
Fax: +31 0 53 428 3377

United Arab Emirates

PO Box 61355
Warehouse TB01, R/A 8
Jebel Ali Free Zone, Dubai
Tel: +971 4 883 8689
Fax: +971 4 883 8674

India

1001, Wing 'C', 10th Floor
Godrej Coliseum, Sion
Mumbai 400022, India
Tel: +91 22 6131 0600
Fax: +91 22 6741 7405
Email: info.india@tycofp.com

Shanghai

2F, Building No.1
Lane 955, Jinhai Road
Pudong, Shanghai 201206
Tel: +86 21 6163 3373
Fax: +86 21 6163 3371
Email: info.china@tycofp.com

Hong Kong

Units 905-923, 9/F, Trade Square
681 Cheung Sha Wan Road
Cheung Sha Wan, Kowloon
Hong Kong
Tel: +852 2753 3524
Fax: +852 2505 5826
Email: info.china@tycofp.com