







ELLIPSE

FRAGRANITE 33" DOUBLE BOWL SINK Model EDXX33229-1

TECHNICAL FEATURES

Overall Sink Size (OD)	33" x 22"
Bowl Size (ID)	29 ⁷ / ₈ " x 17"
Bowl Depth (ID)	9"
Corner Radius	25mm
Minimum Cabinet Size	36"
Installation Type	Dual Mount
Weight	42 lbs
Warranty	Limited Lifetime

AVAILABLE FINISHES

 Champagne EDCH33229-1 114.0155.297	 Onyx EDOX33229-1 114.0087.733
 Stone Grey EDSG33229-1 114.0637.896	 Oyster EDOY33229-1 114.0637.895
 Polar White EDPW33229-1 114.0643.362	 Matte Black EDMB33229-1 114.0699.537
 Mocha EDDB33229-1 114.0155.298	 Slate Grey EDSL33229-1 114.0713.072

OPTIONAL ACCESSORIES

Bottom Grid FBGG1114 112.0185.330	Accessory System AIUS100 112.0655.481	Accessory System AIUS200 112.0655.488
Accessory System AIUS300 112.0655.489	Colorline Strainer 900-XXX (xxx represents color)	Colorline Flange WD-900-XXX (xxx represents color)
Strainer Chrome 1145 112.0055.508		

Product Image



Dimensional Drawing

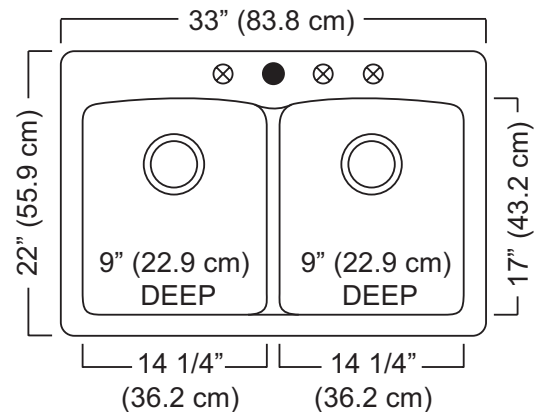

4 pre-scored holes for faucet and accessories

