

INSTALLATION INSTRUCTIONS

ML14XC1 SPLIT SYSTEM AC UNIT

(R410A REFRIGERANT)

THIS MANUAL MUST BE LEFT WITH THE HOMEOWNER FOR FUTURE REFERENCE

⚠ WARNING

Improper installation, adjustment, alteration, service or maintenance can cause property damage, personal injury or loss of life. Installation and service must be performed by a licensed professional HVAC installer or equivalent, or service agency.

General

This ML14XC1 outdoor heat pump **with all-aluminum coil** is designed for use with HFC-410A refrigerant only. This unit must be installed with an approved indoor air handler or coil. See the ML14XC1 product specifications bulletin for approved indoor component match ups. These instructions are intended as a general guide and do not supersede local codes in any way. Consult authorities having jurisdiction before installation.

NOTICE!

Charging information is given on the charging procedure sticker on the unit access panel.

⚠ IMPORTANT

The Clean Air Act of 1990 bans the intentional venting of refrigerant (CFCs, HCFCs and HFCs) as of July 1, 1992. Approved methods of recovery, recycling or reclaiming must be followed. Fines and/or incarceration may be levied for noncompliance.

⚠ CAUTION

As with any mechanical equipment, contact with sharp sheet metal edges can result in personal injury. Take care while handling this equipment and wear gloves and protective clothing.

IMPORTANT: Special procedures are required for cleaning the all-aluminum coil in this unit. See page 18 in this instruction for information.

STEP 1 – SETTING THE UNIT – Clearances

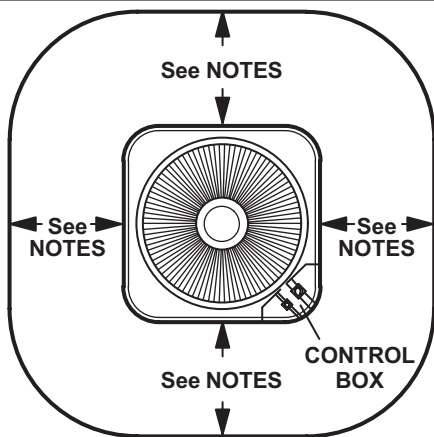

NOTES -

Service clearance of 30 in. (762 mm) must be maintained on one of the sides adjacent to the control box.

Clearance to one of the other three sides must be 36 in. (914 mm).

Clearance to one of the remaining two sides may be 12 in. (305 mm) and the final side may be 6 in. (152 mm).

A clearance of 24 in. must be maintained between two units.

48 in. (1219 mm) clearance required on top of unit.

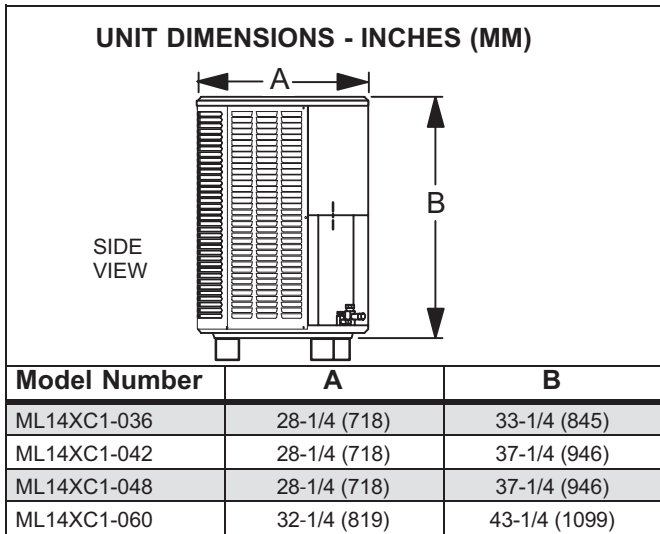

FIGURE 1. Unit Dimensions

**STEP 1 – SETTING THE UNIT
(Continued) – Unit Placement**

NOTICE!

Roof Damage!

This system contains both refrigerant and oil. Some rubber roofing material may absorb oil, causing the rubber to degrade. Failure to follow this notice could result in damage to roof surface.

! IMPORTANT

This unit must be matched with an indoor coil as specified in the engineering handbook. Coils previously charged with HCFC-22 must be flushed.

! WARNING

To prevent personal injury, as well as damage to panels, unit or structure, observe the following:

While installing or servicing this unit, carefully stow all removed panels so that the panels will not cause injury to personnel, objects or nearby structures. Also, take care to store panels where they will not be subject to damage (e.g., being bent or scratched).

While handling or stowing the panels, consider any weather conditions (especially wind) that may cause panels to be blown around and damaged.

! IMPORTANT

Exhaust vents from dryers, water heaters and furnaces should be directed away from the outdoor unit. Prolonged exposure to exhaust gases and the chemicals contained within them may cause condensation to form on the steel cabinet and other metal components of the outdoor unit. This will diminish unit performance and longevity

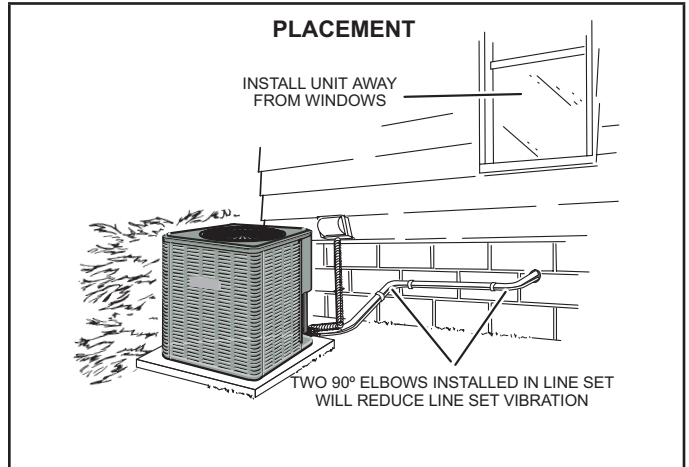

FIGURE 2

SLAB MOUNTING

Install unit level or, if on a slope, maintain slope tolerance of 2 degrees (or 2 inches per 5 feet [50 mm per 1.5 m]) away from building structure.

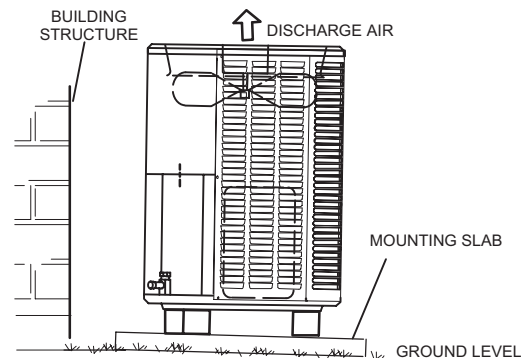

FIGURE 3

! IMPORTANT

This model is designed for use in check / expansion valve systems only. An indoor expansion valve approved for use with HFC-410A refrigerant must be ordered separately and installed prior to operating the system.

NOTE - An optional Unit Stand-Off Kit (94J45) is available for this unit. Black high-density polyethylene feet raise unit off of mounting surface away from damaging moisture. Four feet are furnished per order number.

STEP 2 – REFRIGERANT PIPING

IMPORTANT

If this unit is being matched with an approved line set or indoor unit coil that was previously charged with mineral oil, or if it is being matched with a coil which was manufactured before January of 1999, the coil and line set must be flushed prior to installation. Take care to empty all existing traps. Polyol ester (POE) oils are used in units charged with HFC-410A refrigerant. Residual mineral oil can act as an insulator, preventing proper heat transfer. It can also clog the expansion device and reduce system performance and capacity. Failure to properly flush the system per this instruction and the detailed installation and service procedures manual will void the warranty.

Flush the existing line set per the following instructions. CAUTION - DO NOT attempt to flush and re-use existing line sets or indoor coil when the system contains contaminants (i.e., compressor burn out).

If a new line set is being installed, size the piping per table 1.

TABLE 1

REFRIGERANT LINE SET – INCHES (MM)					
Model	Valve Field Connections		Recommended Line Set		
	Liquid Line	Suction Line	Liquid Line	Suction Line	L15 Line Sets
-036	3/8 in. (10 mm)	7/8 in. (22 mm)	3/8 in. (10 mm)	7/8 in. (22 mm)	L15-65 15 ft. - 50 ft. (4.6 m - 15 m)
-042					
-048					
-060	3/8 in. (10 mm)	1-1/8 in. (28 mm)	3/8 in. (10 mm)	1-1/8 in. (28 mm)	Field Fabricated

NOTE - Some applications may require a field-provided 7/8" to 1-1/8" adapter.

NOTE - When installing refrigerant lines longer than 50 feet, refer to the Refrigerant Piping Design and Fabrication Guidelines manual.

WARNING



When using a high pressure gas such as nitrogen to pressurize a refrigeration or air conditioning system, use a regulator that can control the pressure down to 1 or 2 psig (6.9 to 13.8 kPa).

WARNING

Refrigerant can be harmful if it is inhaled. Refrigerant must be used and recovered responsibly.

Failure to follow this warning may result in personal injury or death.

WARNING



Fire, Explosion and Personal Safety hazard. Failure to follow this warning could result in damage, personal injury or death.

Never use oxygen to pressurize or purge refrigeration lines. Oxygen, when exposed to a spark or open flame, can cause fire and/or an explosion, that could result in property damage, personal injury or death.

WARNING

Polyol ester (POE) oils used with HFC-410A refrigerant absorb moisture very quickly. It is very important that the refrigerant system be kept closed as much as possible. DO NOT remove line set caps or service valve stub caps until you are ready to make connections.

IMPORTANT

Some scroll compressors have an internal vacuum protector that will unload scrolls when suction pressure goes below 20 psig. A hissing sound will be heard when the compressor is running unloaded. Protector will reset when low pressure in system is raised above 40 psig. DO NOT REPLACE COMPRESSOR.

STEP 2 – REFRIGERANT PIPING – (Continued)

1A TYPICAL EXISTING FIXED ORIFICE REMOVAL PROCEDURE (UNCASED COIL SHOWN)

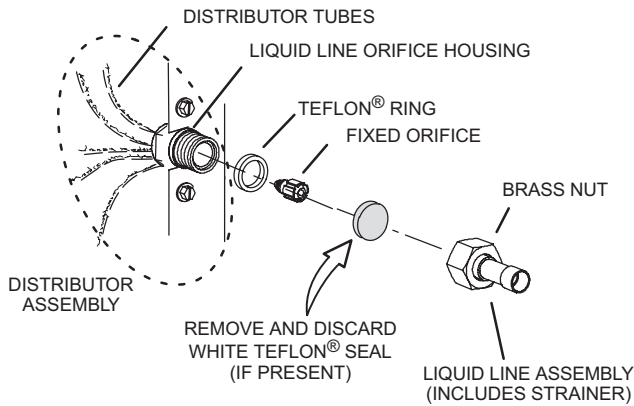

- A - On fully cased coils, remove the coil access and plumbing panels.
- B - Remove any shipping clamps from the liquid line and distributor assembly.
- C - Using two wrenches, disconnect liquid line from liquid line orifice housing. Take care not to twist or damage distributor tubes during this process.
- D - Remove and discard fixed orifice, valve stem assembly (if present) and Teflon® washer as illustrated above.
- E - Use a field-provided fitting to temporarily reconnect the liquid line to the indoor unit's liquid line orifice housing.

OR 1B TYPICAL EXISTING EXPANSION VALVE REMOVAL PROCEDURE (UNCASED COIL SHOWN)

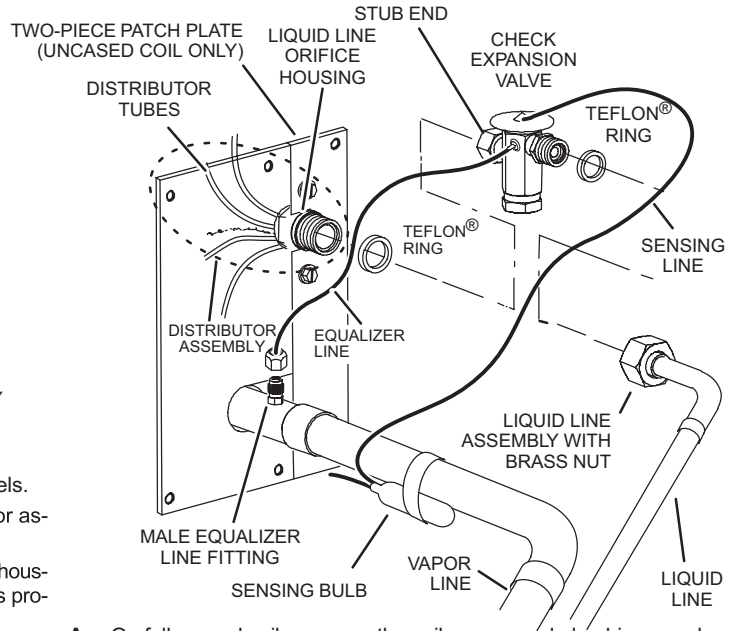

- A - On fully cased coils, remove the coil access and plumbing panels.
- B - Remove any shipping clamps from the liquid line and distributor assembly.
- C - Disconnect the equalizer line from the check expansion valve equalizer line fitting on the vapor line.
- D - Remove the vapor line sensing bulb.
- E - Disconnect the liquid line from the check expansion valve at the liquid line assembly.
- F - Disconnect the check expansion valve from the liquid line orifice housing. Take care not to twist or damage distributor tubes during this process.
- G - Remove and discard check expansion valve and the two Teflon® rings.
- H - Use a field-provided fitting to temporarily reconnect the liquid line to the indoor unit's liquid line orifice housing.

2 CONNECT GAUGES AND EQUIPMENT FOR FLUSHING PROCEDURE

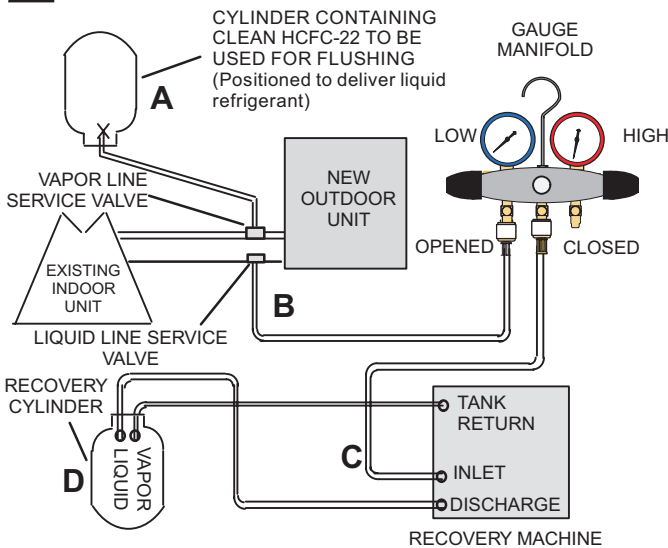

- A - HCFC-22 cylinder with clean refrigerant (positioned to deliver liquid refrigerant) to the vapor service valve.
- B - HCFC-22 gauge set (low side) to the liquid line valve.
- C - HCFC-22 gauge set center port to inlet on the recovery machine with an empty recovery tank connected to the gauge set.
- D - Connect recovery tank to recovery machine per machine instructions.

3 FLUSHING LINE SET

The line set and indoor unit coil must be flushed with at least the same amount of clean refrigerant that previously charged the system. Check the charge in the flushing cylinder before proceeding.

- A - Set the recovery machine for liquid recovery and start the recovery machine. Open the gauge set valves to allow the recovery machine to pull a vacuum on the existing system line set and indoor unit coil.
- B - Position the cylinder of clean HCFC-22 for delivery of liquid refrigerant and open its valve to allow liquid refrigerant to flow into the system through the vapor line valve. Allow the refrigerant to pass from the cylinder and through the line set and the indoor unit coil before it enters the recovery machine.
- C - After all of the liquid refrigerant has been recovered, switch the recovery machine to vapor recovery so that all of the HCFC-22 vapor is recovered. Allow the recovery machine to pull the system down to 0.
- D - Close the valve on the inverted HCFC-22 drum and the gauge set valves. Pump the remaining refrigerant out of the recovery machine and turn the machine off.

FIGURE 4

STEP 2 – REFRIGERANT PIPING – Brazing Procedures

1 CUT AND DEBUR

Cut ends of the refrigerant lines square (free from nicks or dents) and debur the ends. The pipe must remain round. Do not crimp end of the line.

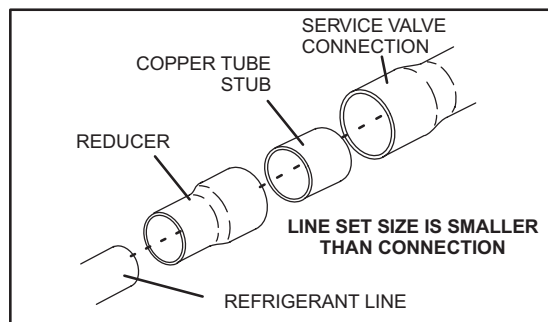
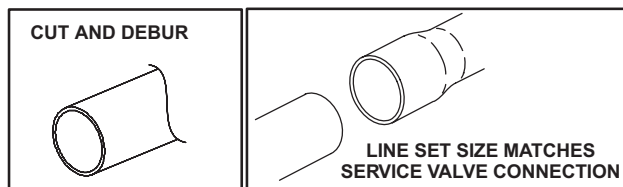

DO NOT CRIMP SERVICE VALVE CONNECTOR WHEN PIPE IS SMALLER THAN CONNECTION

2 CAP AND CORE REMOVAL

Remove service cap and core from both the vapor and liquid line service ports.

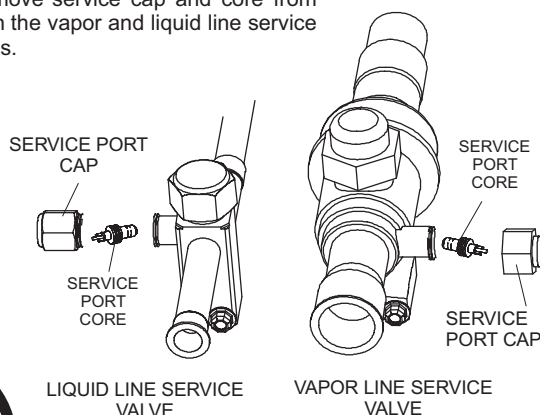

3 ATTACH THE MANIFOLD GAUGE SET FOR BRAZING LIQUID AND VAPOR LINE SERVICE VALVES

Flow regulated nitrogen (at 1 to 2 psig) through the low-side refrigeration gauge set into the liquid line service port valve, and out of the vapor line service port valve.

- A - Connect gauge set low pressure side to liquid line service valve (service port).
- B - Connect gauge set center port to bottle of nitrogen with regulator.
- C - Remove core from valve in vapor line service port to allow nitrogen to escape.

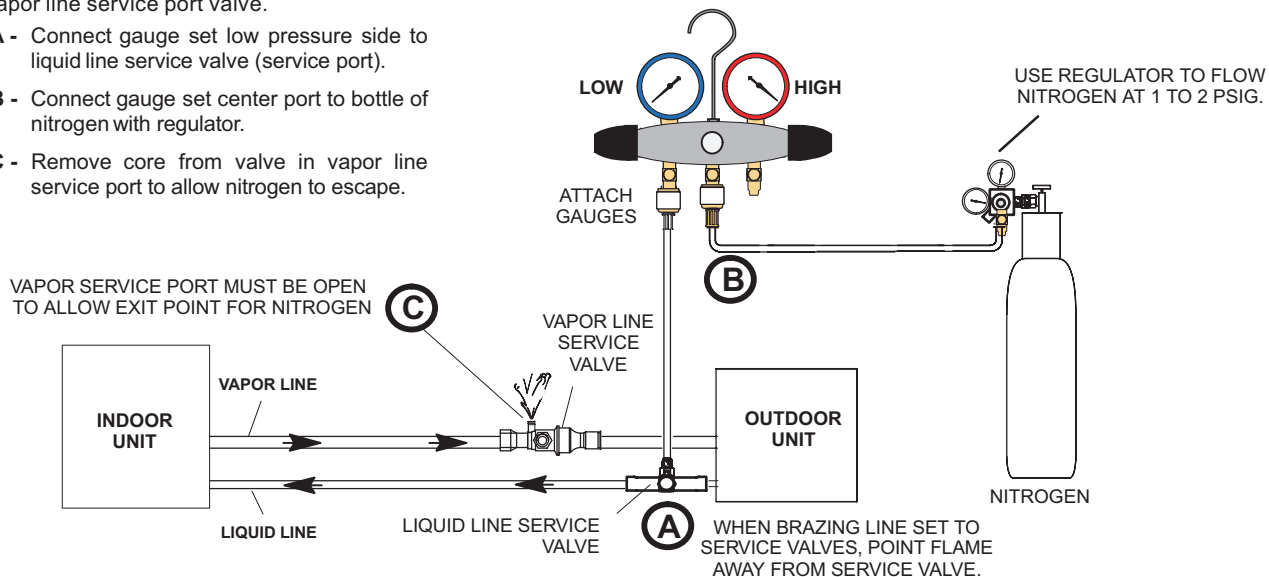

FIGURE 5

⚠ CAUTION

Brazing alloys and flux contain materials which are hazardous to your health. Avoid breathing vapors or fumes from brazing operations. Perform operations only in well-ventilated areas. Wear gloves and protective goggles or face shield to protect against burns. Wash hands with soap and water after handling brazing alloys and flux.

⚠ WARNING



Danger of fire. Bleeding the refrigerant charge from only the high side may result in pressurization of the low side shell and suction tubing. Application of a brazing torch to a pressurized system may result in ignition of the refrigerant and oil mixture. Check the high and low pressures before applying heat.

4 WRAP SERVICE VALVES

To help protect service valve seals during brazing, wrap water-saturated cloths around service valve bodies and copper tube stubs. Use additional water-saturated cloths underneath the valve body to protect the base paint.

5 FLOW NITROGEN

Flow regulated nitrogen (at 1 to 2 psig) through the refrigeration gauge set into the valve stem port connection on the liquid service valve and out of the vapor valve stem port. See steps 3A, 3B and 3C on manifold gauge set connections.

6 BRAZE LINE SET

Wrap both service valves with water-saturated cloths as illustrated here and as mentioned in step 4, before brazing to line set. Cloths must remain water-saturated throughout the brazing and cool-down process.

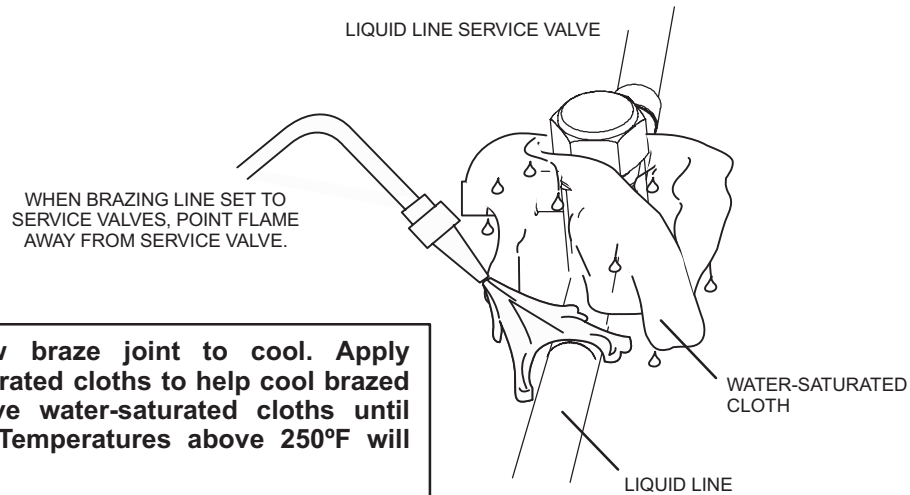

IMPORTANT — Allow braze joint to cool. Apply additional water-saturated cloths to help cool brazed joint. Do not remove water-saturated cloths until piping has cooled. Temperatures above 250°F will damage valve seals.

WARNING



FIRE, PERSONAL INJURY, OR PROPERTY DAMAGE may result if you do not wrap a water-saturated cloth around both liquid and suction line service valve bodies and copper tube stub while brazing the line set! The braze, when complete, must be quenched with water to absorb any residual heat.



Do not open service valves until refrigerant lines and indoor coil have been leak-tested and evacuated. Refer to Installation and Service Procedures manual.

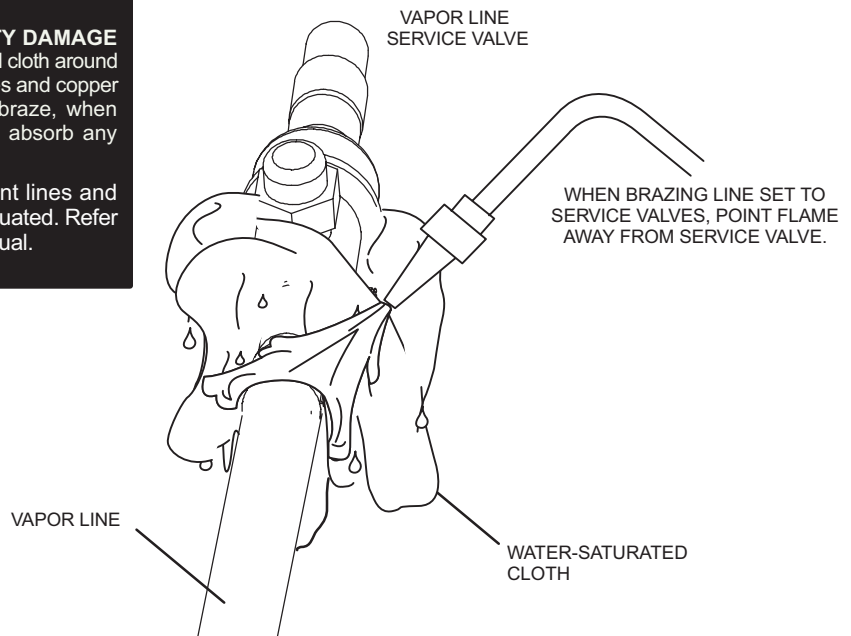

7 PREPARATION FOR NEXT STEP

After all connections have been brazed, disconnect manifold gauge set from service ports. Apply additional water-saturated cloths to both services valves to cool piping. Once piping is cool, remove all water-saturated cloths.

FIGURE 6

STEP 2 – REFRIGERANT PIPING – Install Indoor Expansion Valve

This outdoor unit is designed for use in systems that include an expansion valve metering device (purchased separately) at the indoor coil. See the ML14XC1 specifications for approved expansion valve kit match-ups and application information. The check expansion valve unit can be installed internal or external to the indoor coil. In applications where an uncased coil is being installed in a field-provided plenum, install the check/expansion valve in a manner that will provide access for future field service of the expansion valve. Refer to below illustration for reference during installation of expansion valve unit.

INDOOR EXPANSION VALVE INSTALLATION

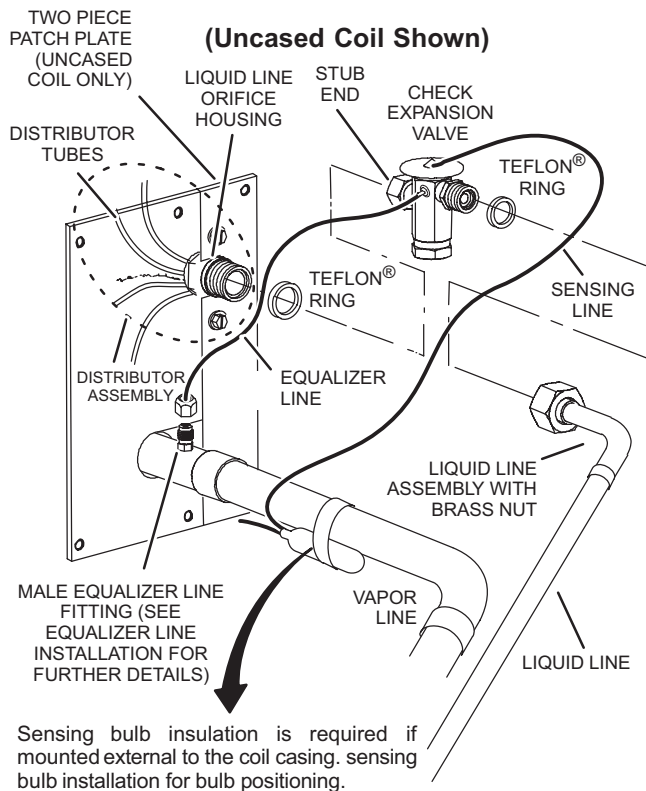

- 3 - Install one of the provided Teflon® rings around the stubbed end of the check expansion valve and lightly lubricate the connector threads and expose surface of the Teflon® ring with refrigerant oil.
- 4 - Attach the stubbed end of the check expansion valve to the liquid line orifice housing. Finger tighten and use an appropriately sized wrench to turn an additional 1/2 turn clockwise as illustrated in the figure above, or tighten to 20 ft-lb.
- 5 - Place the remaining Teflon® washer around the other end of the check expansion valve. Lightly lubricate connector threads and expose surface of the Teflon® ring with refrigerant oil.
- 6 - Attach the liquid line assembly to the check expansion valve. Finger tighten and use an appropriately sized wrench to turn an additional 1/2 turn clockwise as illustrated in the figure above or tighten to 20 ft-lb.

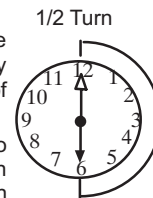

SENSING BULB INSTALLATION

- 1 - Attach the vapor line sensing bulb in the proper orientation as illustrated to the right using the clamp and screws provided.

NOTE - Though it is preferred to have the sensing bulb installed on a horizontal run of the vapor line, installation on a vertical run of piping is acceptable if necessary.

NOTE - Confirm proper thermal contact between vapor line and check/expansion bulb before insulating the sensing bulb once installed.

- 2 - Connect the equalizer line from the check expansion valve to the equalizer vapor port on the vapor line. Finger tighten the flare nut plus 1/8 turn (7 ft-lbs) as illustrated below.

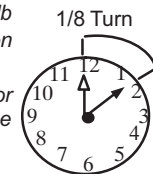

EQUALIZER LINE INSTALLATION

- 1 - Remove and discard either the flare seal cap or flare nut with copper flare seal bonnet from the equalizer line port on the vapor line as illustrated in the figure below.
- 2 - Remove the field-provided fitting that temporarily reconnected the liquid line to the indoor unit's distributor assembly.

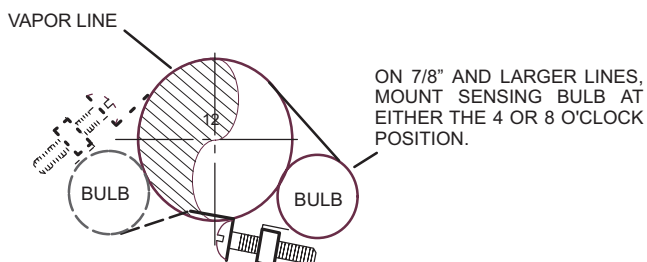
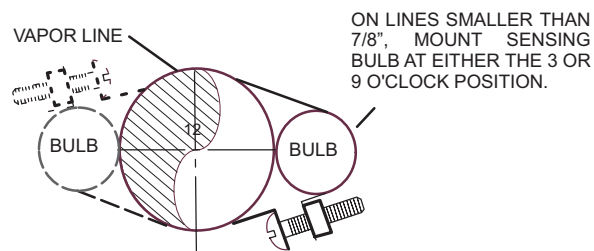
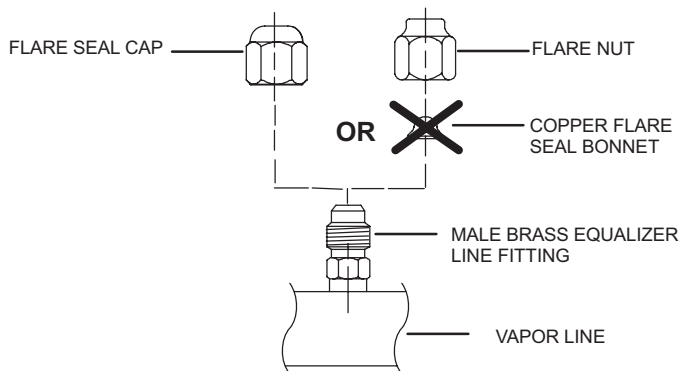

NOTE - NEVER MOUNT THE SENSING BULB ON BOTTOM OF LINE.

FIGURE 7

STEP 3 – LEAK TEST AND EVACUATION

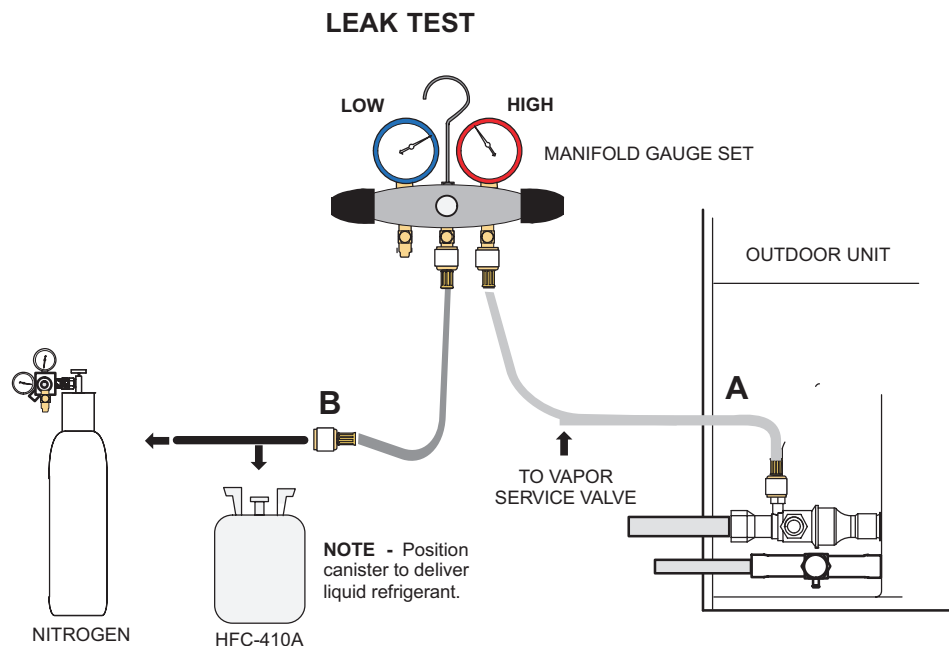

1 CONNECT GAUGE SET

A - Connect the high pressure hose of an HFC-410A manifold gauge set to the vapor valve service port.

NOTE - Normally, the high pressure hose is connected to the liquid line port. However, connecting it to the vapor port better protects the manifold gauge set from high pressure damage.

B - With both manifold valves closed, connect the cylinder of HFC-410A refrigerant to the center port of the manifold gauge set.

NOTE - Later in the procedure, the HFC-410A container will be replaced by the nitrogen container.

2 TEST FOR LEAKS

After the line set has been connected to the indoor and outdoor units, check the line set connections and indoor unit for leaks. Use the following procedure to test for leaks:

A - With both manifold valves closed, connect the cylinder of HFC-410A refrigerant to the center port of the manifold gauge set. Open the valve on the HFC-410A cylinder (vapor only).

B - Open the high pressure side of the manifold to allow HFC-410A into the line set and indoor unit. Weigh in a trace amount of HFC-410A. [A trace amount is a maximum of two ounces (57 g) refrigerant or three pounds (31 kPa) pressure.] Close the valve on the HFC-410A cylinder and the valve on the high pressure side of the manifold gauge set. Disconnect the HFC-410A cylinder.

C - Connect a cylinder of nitrogen with a pressure regulating valve to the center port of the manifold gauge set.

D - Adjust nitrogen pressure to 150 psig (1034 kPa). Open the valve on the high side of the manifold gauge set in order to pressurize the line set and the indoor unit.

E - After a few minutes, open one of the service valve ports and verify that the refrigerant added to the system earlier is measurable with a leak detector.

F - After leak testing, disconnect gauges from service ports.

FIGURE 8

3 CONNECT GAUGE SET

NOTE - Remove cores from service valves (if not already done).

- A - Connect low side of manifold gauge set with 1/4 SAE in-line tee to vapor line service valve
- B - Connect high side of manifold gauge set to liquid line service valve
- C - Connect available micron gauge connector on the 1/4 SAE in-line tee.
- D - Connect the vacuum pump (with vacuum gauge) to the center port of the manifold gauge set. The center port line will be used later for both the HFC-410A and nitrogen containers.

NOTE - Position canister to deliver liquid refrigerant.

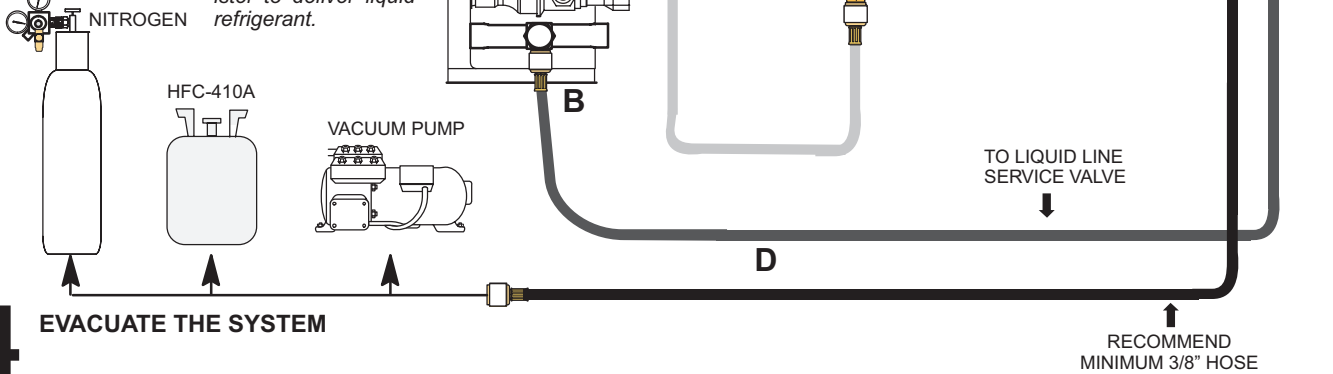

4 EVACUATE THE SYSTEM

- A - Open both manifold valves and start the vacuum pump.
- B - Evacuate the line set and indoor unit to an **absolute pressure** of 23,000 microns (29.01 inches of mercury).
 - NOTE** - During the early stages of evacuation, it is desirable to close the manifold gauge valve at least once. A rapid rise in pressure indicates a relatively large leak. If this occurs, **repeat the leak testing procedure**.
 - NOTE** - The term **absolute pressure** means the total actual pressure above absolute zero within a given volume or system. Absolute pressure in a vacuum is equal to atmospheric pressure minus vacuum pressure.
- C - When the absolute pressure reaches 23,000 microns (29.01 inches of mercury), perform the following:
 - Close manifold gauge valves.
 - Close valve on vacuum pump.
 - Turn off vacuum pump.
 - Disconnect manifold gauge center port hose from vacuum pump.
 - Attach manifold center port hose to a nitrogen cylinder with pressure regulator set to 150 psig (1034 kPa) and purge the hose.
 - Open manifold gauge valves to break the vacuum in the line set and indoor unit.
 - Close manifold gauge valves.
- D - Shut off the nitrogen cylinder and remove the manifold gauge hose from the cylinder. Open the manifold gauge valves to release the nitrogen from the line set and indoor unit.
- E - Reconnect the manifold gauge to the vacuum pump, turn the pump on, and continue to evacuate the line set and indoor unit until the absolute pressure does not rise above 500 microns (29.9 inches of mercury) within a 20-minute period after shutting off the vacuum pump and closing the manifold gauge valves.
- F - When the absolute pressure requirement above has been met, disconnect the manifold hose from the vacuum pump and connect it to a cylinder of HFC-410A positioned to deliver liquid refrigerant. Open the manifold gauge valve 1 to 2 psig in order to release the vacuum in the line set and indoor unit.
- G - Perform the following:
 - Close manifold gauge valves.
 - Shut off HFC-410A cylinder.
 - Reinstall service valve cores by removing manifold hose from service valve. Quickly install cores with core tool while maintaining a positive system pressure.
 - Replace stem caps and finger tighten them, then tighten an additional one-sixth (1/6) of a turn as illustrated.

WARNING !

Possible equipment damage.

Avoid deep vacuum operation. Do not use compressors to evacuate a system. Extremely low vacuum can cause internal arcing and compressor failure. Damage caused by deep vacuum operation will void warranty.

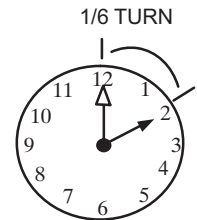

FIGURE 9

STEP 4 – ELECTRICAL – Circuit Sizing and Wire Routing

In the U.S.A., wiring must conform with current local codes and the current National Electric Code (NEC). In Canada, wiring must conform with current local codes and the current Canadian Electrical Code (CEC).

Refer to the furnace or air handler installation instructions for additional wiring application diagrams and refer to unit nameplate for minimum circuit ampacity and maximum overcurrent protection size.

24VAC TRANSFORMER

Use the transformer provided with the furnace or air handler for low-voltage control power (24VAC - 40 VA minimum)

⚠ WARNING



Electric Shock Hazard. Can cause injury or death. Unit must be properly grounded in accordance with national and local codes.

Line voltage is present at all components when unit is not in operation on units with single-pole contactors. Disconnect all remote electric power supplies before opening access panel. Unit may have multiple power supplies.

⚠ WARNING

Fire Hazard. Use of aluminum wire with this product may result in a fire, causing property damage, severe injury or death. Use copper wire only with this product.

⚠ WARNING

Failure to use properly sized wiring and circuit breaker may result in property damage. Size wiring and circuit breaker(s) per Product Specifications bulletin (EHB/Spec Sheet) and unit rating plate.

⚠ WARNING

ELECTROSTATIC DISCHARGE (ESD)
Precautions and Procedures

Electrostatic discharge can affect electronic components. Take care during unit installation and service to protect the unit's electronic controls. Precautions will help to avoid control exposure to electrostatic discharge by putting the unit, the control and the technician at the same electrostatic potential. Touch hand and all tools on an unpainted unit surface before performing any service procedure to neutralize electrostatic charge.

SIZE CIRCUIT AND INSTALL SERVICE DISCONNECT SWITCH

Refer to the unit nameplate for minimum circuit ampacity, and maximum fuse or circuit breaker (HACR per NEC). Install power wiring and properly sized disconnect switch.

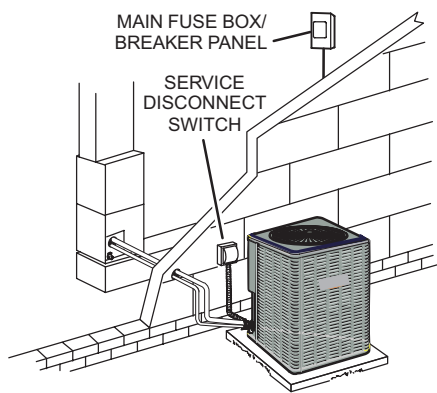

NOTE - Units are approved for use only with copper conductors. Ground unit at disconnect switch or connect to an earth ground.

INSTALL THERMOSTAT

Install room thermostat (ordered separately) on an inside wall approximately in the center of the conditioned area and 5 feet (1.5m) from the floor. It should not be installed on an outside wall or where it can be affected by sunlight or drafts.

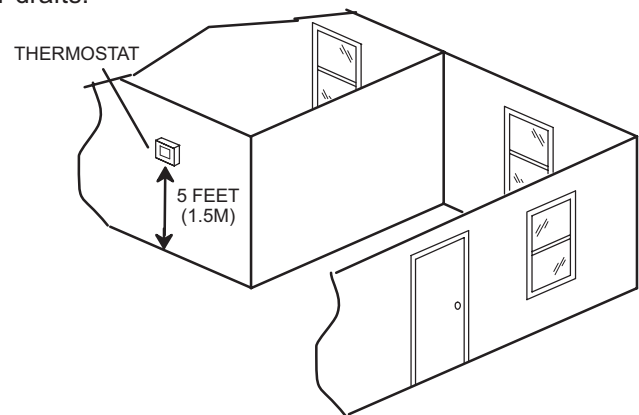

NOTE - 24VAC, Class II circuit connections are made in the control panel.

FIGURE 10

STEP 4 – ELECTRICAL – (Continued) – High Voltage and Field Control Wiring

ROUTING HIGH VOLTAGE/ GROUND AND CONTROL WIRING

HIGH VOLTAGE / GROUND WIRES

Any excess high voltage field wiring should be trimmed and secured away from any low voltage field wiring. To facilitate a conduit, a cutout is located in the bottom of the control panel. Connect conduit to the control panel using a proper conduit fitting.

- HIGH VOLTAGE FIELD WIRING
- LOW VOLTAGE FIELD WIRING
- FACTORY WIRING

CONTROL WIRING

NOTE — Wire tie provides low voltage control wire strain relief and to maintain separation of field installed low and high voltage circuits.

NOTE — For proper voltages, select thermostat wire (control wires) gauge per table above.

NOTE — Do not bundle any excess 24VAC control wires inside control panel.

Install low voltage wiring from outdoor to indoor unit and from thermostat to indoor unit as illustrated.

- A** Run 24VAC control wires through hole with grommet and secure with provided wire tie.
- B** Make 24VAC thermostat wire connections. Locate the two wires from the contactor and make connection using field provided wire nuts:
 - Yellow to Y1
 - Black to C (common)

WIRE RUN LENGTH	AWG#	INSULATION TYPE
LESS THAN 100' (30 METERS)	18	TEMPERATURE RATING
MORE THAN 100' (30 METERS)	16	35°C MINIMUM.

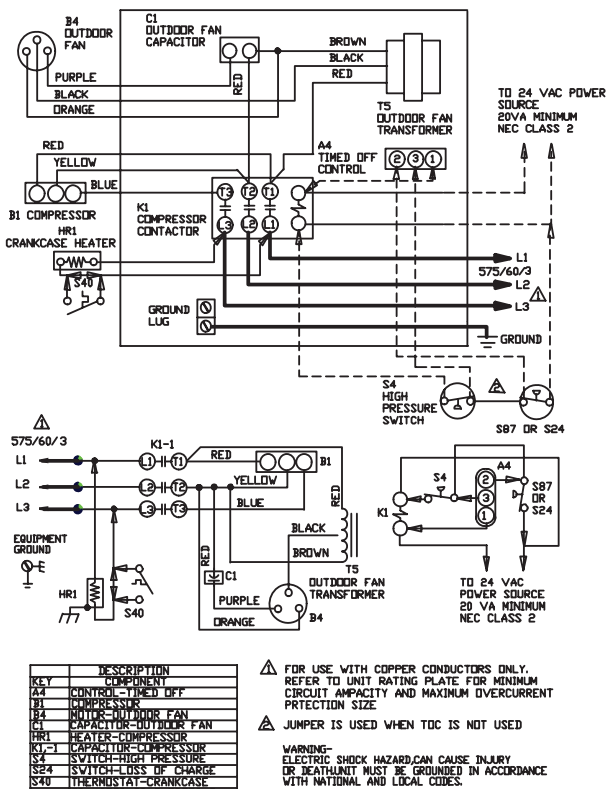
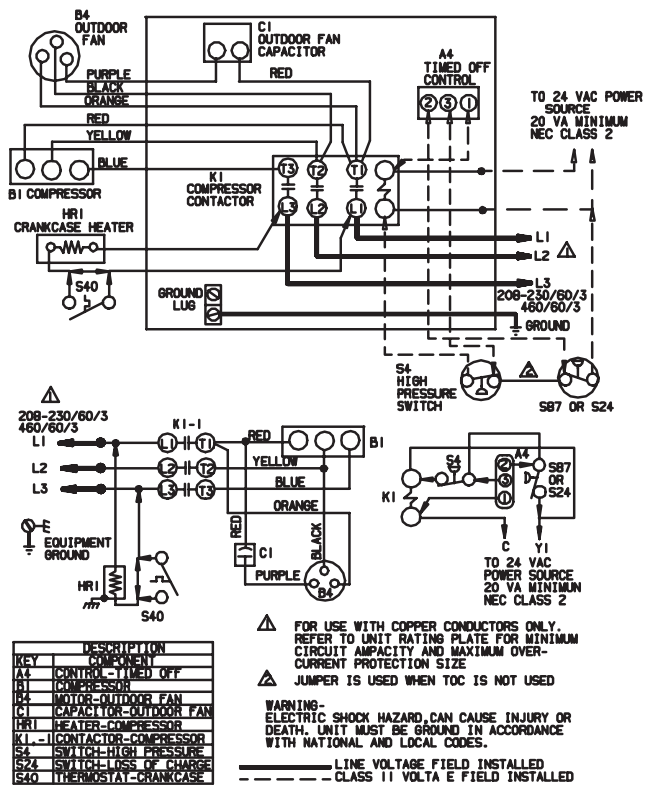
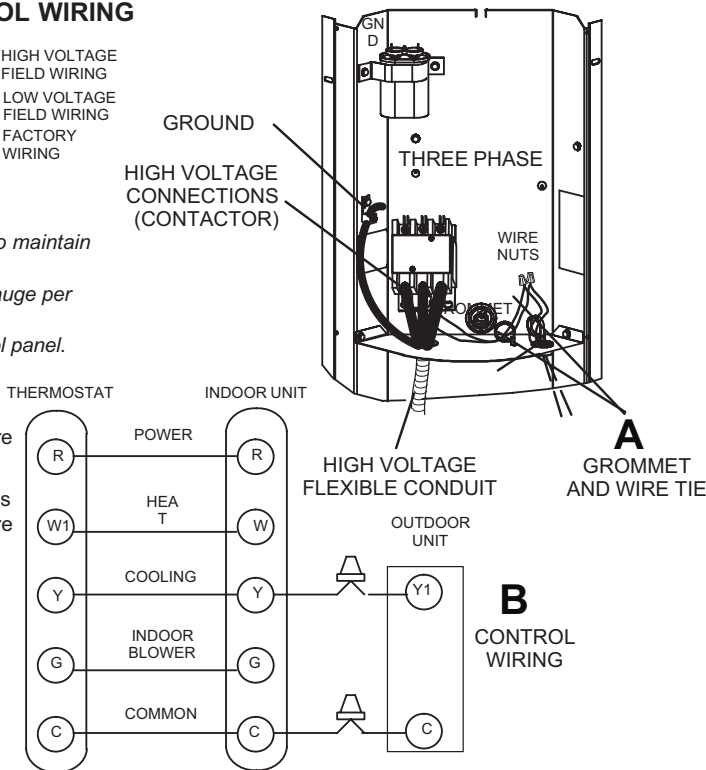

Typical Field Wiring Diagram (Y and G Voltages)

Typical Field Wiring Diagram (J Voltage)

FIGURE 11

STEP 5 – UNIT START-UP

⚠ IMPORTANT

If unit is equipped with a crankcase heater, it should be energized 24 hours before unit start-up to prevent compressor damage as a result of slugging.

- 1 - Rotate fan to check for binding.
- 2 - Inspect all factory- and field-installed wiring for loose connections.
- 3 - After evacuation is complete, open the liquid line and vapor line service valve stems to release the refrigerant charge (contained in outdoor unit) into the system.
- 4 - Replace the stem caps and tighten to the value listed in table 2.
- 5 - Check voltage supply at the disconnect switch. The voltage must be within the range listed on the unit's nameplate. If not, do not start the equipment until you have consulted with the power company and the voltage condition has been corrected.
- 6 - Connect manifold gauge set for testing and charging.
- 7 - Set the thermostat for a cooling demand. Turn on power to the indoor indoor unit and close the outdoor unit disconnect switch to start the unit.
- 8 - Recheck voltage while the unit is running. Power must be within range shown on the unit nameplate.
- 9 - Check system for sufficient refrigerant using the procedures outlined under *Checking Refrigerant Charge*.

OPERATING MANIFOLD GAUGE SET AND SERVICE VALVES

The liquid and vapor line service valves are used for removing refrigerant, flushing, leak testing, evacuating, checking charge and charging.

Each valve is equipped with a service port which has a factory-installed valve stem. Figures 15 and 16 provide information on how to access and operate both angle- and ball-type service valves.

Torque Requirements

When servicing or repairing heating, ventilating and air conditioning components, ensure the fasteners are appropriately tightened. Table 2 lists torque values for fasteners.

**TABLE 2
TORQUE REQUIREMENTS**

Parts	Recommended Torque	
Service valve cap	8 ft.-lb.	11 NM
Sheet-metal screws	16 in.-lb.	2 NM
Machine screws #10	28 in.-lb.	3 NM
Compressor bolts	90 in.-lb.	10 NM
Gauge port seal cap	8 ft.-lb.	11 NM

⚠ IMPORTANT

To prevent stripping of the various caps used, the appropriately sized wrench should be used and fitted snugly over the cap before tightening.

Using Manifold Gauge Set

When checking the system charge, only use a manifold gauge set that features low loss anti-blow back fittings.

Manifold gauge set used with HFC-410A refrigerant systems must be capable of handling the higher system operating pressures. The gauges should be rated for use with pressures of 0 - 800 psig on the high side and a low side of 30" vacuum to 250 psig with dampened speed to 500 psi. Gauge hoses must be rated for use at up to 800 psig of pressure with a 4000 psig burst rating.

OPERATING BALL-TYPE SERVICE VALVE

- 1 - Remove stem cap with an appropriately sized wrench.
- 2 - Use an appropriately sized wrench to open. To open valve, rotate stem counterclockwise 90°. To close, rotate stem clockwise 90°.

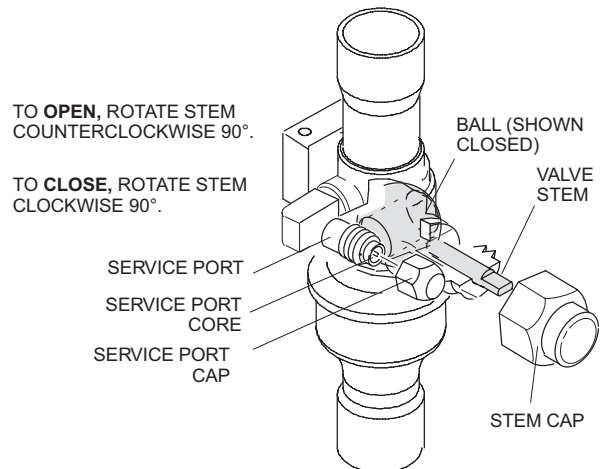
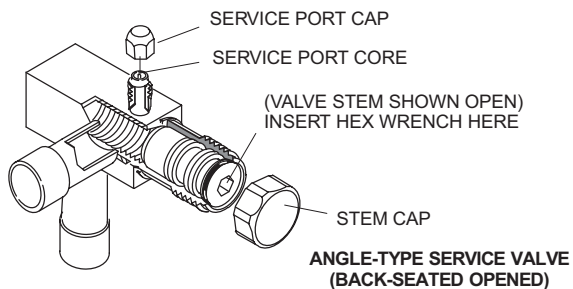

FIGURE 12

OPERATING ANGLE-TYPE SERVICE VALVE

- 1 - Remove stem cap with an appropriately sized wrench.
- 2 - Use a service wrench with a hex-head extension (3/16" for liquid line valve sizes and 5/16" for vapor line valve sizes) to back the stem out counterclockwise as far as it will go.



When service valve is **OPEN**, the service port is open to line set, indoor and outdoor unit.

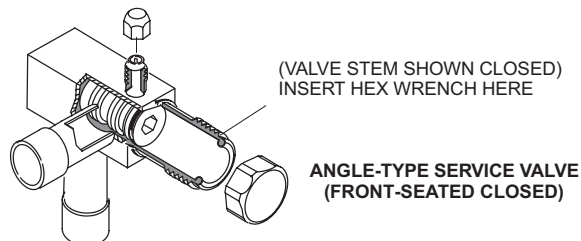

When service valve is **CLOSED**, the service port is open to the line set and indoor unit.

NOTE - A label with specific torque requirements may be affixed to the stem cap. If the label is present, use the specified torque.

FIGURE 13

ACCESS SERVICE PORT

A service port cap protects the service port core from contamination and serves as the primary leak seal.

- 1 - Remove service port cap with an appropriately sized wrench.
- 2 - Connect gauge set to service port.
- 3 - When testing is completed, replace service port cap and tighten as follows:
 - With torque wrench, finger tighten and torque cap per table 2.
 - Without torque wrench, finger tighten and use an appropriately sized wrench to turn an additional 1/6 turn clockwise.

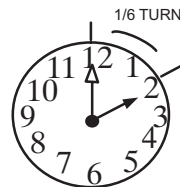

Reinstall Stem Cap

Stem cap protects the valve stem from damage and serves as the primary seal. Replace the stem cap and tighten as follows:

- With torque wrench, finger tighten and then torque cap per table 2.
- Without torque wrench, finger tighten and use an appropriately sized wrench to turn an additional 1/12 turn clockwise.



FIGURE 14

Checking and Adding Refrigerant Charge

The ML14XC1 unit is factory-charged with enough HFC-410A refrigerant to accommodate a 15-foot length of refrigerant piping. **Charge should be checked and adjusted using the tables provided on the charging procedure sticker on the unit access panel.** Detailed information is given in the ML14XC1 Installation and Service Procedures manual.

System Refrigerant

This section outlines procedures for:

- 1 - Checking and adjusting indoor airflow as recommended in figure 16
- 2 - Determine the best method for adding or removing refrigerant as outlined in figure 15.

START: Determine how refrigerant is metered

WHEN TO CHARGE?

- Warm weather best
- Can charge in colder weather

CHARGE METHOD? Determine by:

- Metering device type
- Outdoor ambient temperature

REQUIREMENTS:

- Sufficient heat load in structure
- Indoor temperature between 70-80°F (21-26°C)
- Manifold gauge set connected to unit
- Thermometers:
 - to measure outdoor ambient temperature
 - to measure liquid line temperature
 - to measure suction line temperature

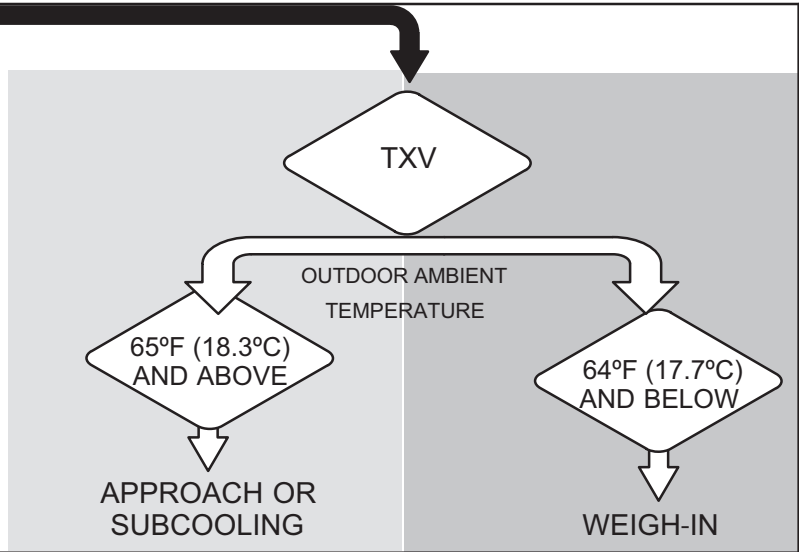
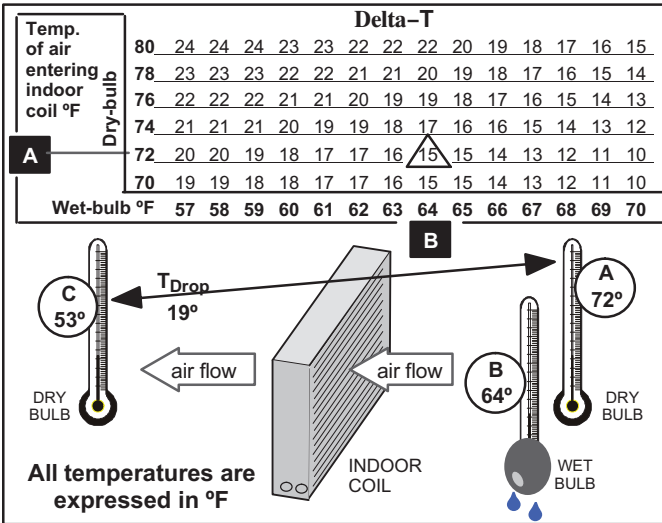

FIGURE 15. Determining Charge Method

CHECKING AIR FLOW AT INDOOR COIL



1. Determine the desired DT—Measure entering air temperature using dry bulb (A) and wet bulb (B). DT is the intersecting value of A and B in the table (see triangle).
2. Find temperature drop across coil—Measure the coil's dry bulb entering and leaving air temperatures (A and C). Temperature Drop Formula: (T_{Drop}) = A minus C.

3. Determine if fan needs adjustment—If the difference between the measured T_{Drop} and the desired DT (T_{Drop}-DT) is within ±3°, no adjustment is needed. See examples: Assume DT = 15 and A temp. = 72°, these C temperatures would necessitate stated actions:

C°	T _{Drop}	-	DT	=	°F	ACTION
53°	19	-	15	=	4	Increase the airflow
58°	14	-	15	=	-1	(within ±3° range) no change
62°	10	-	15	=	-5	Decrease the airflow

4. Adjust the fan speed—See indoor unit instructions to increase/decrease fan speed.

Changing air flow affects all temperatures; recheck temperatures to confirm that the temperature drop and DT are within ±3°.

FIGURE 16. Checking Indoor Airflow over Evaporator Coil using Delta-T Chart

START: Measure outdoor ambient temperature

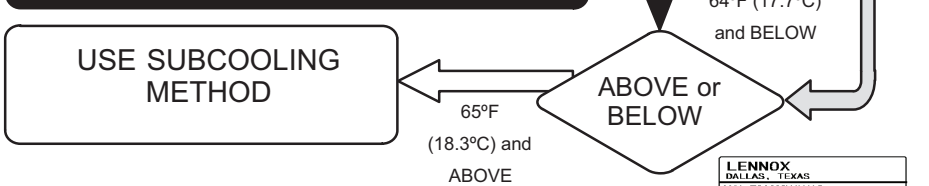

1. Check Liquid and suction line pressures
2. Compare unit pressures with table 3.
3. Conduct leak check; evacuate as previously outlined.
4. Weigh in the unit nameplate charge plus any charge required for line set differences over feet.

Refrigerant Charge per Line Set Length

Liquid Line Set Diameter	Ounces per 5 feet (g per 1.5 m) adjust from 15 feet (4.6 m line set)*
3/8" (9.5 mm)	3 ounces per 5' (85 g per 1.5 m)

NOTE - *If line length is greater than 15 feet (4.6 m), add this amount. If line length is less than 15 feet (4.6 m), subtract this amount.

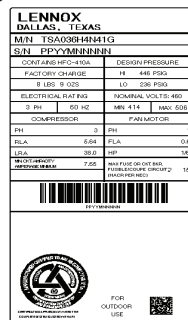

This nameplate is for illustration purposes only. Go to actual nameplate on outdoor unit for charge information.

FIGURE 17. HFC-410A Weigh In

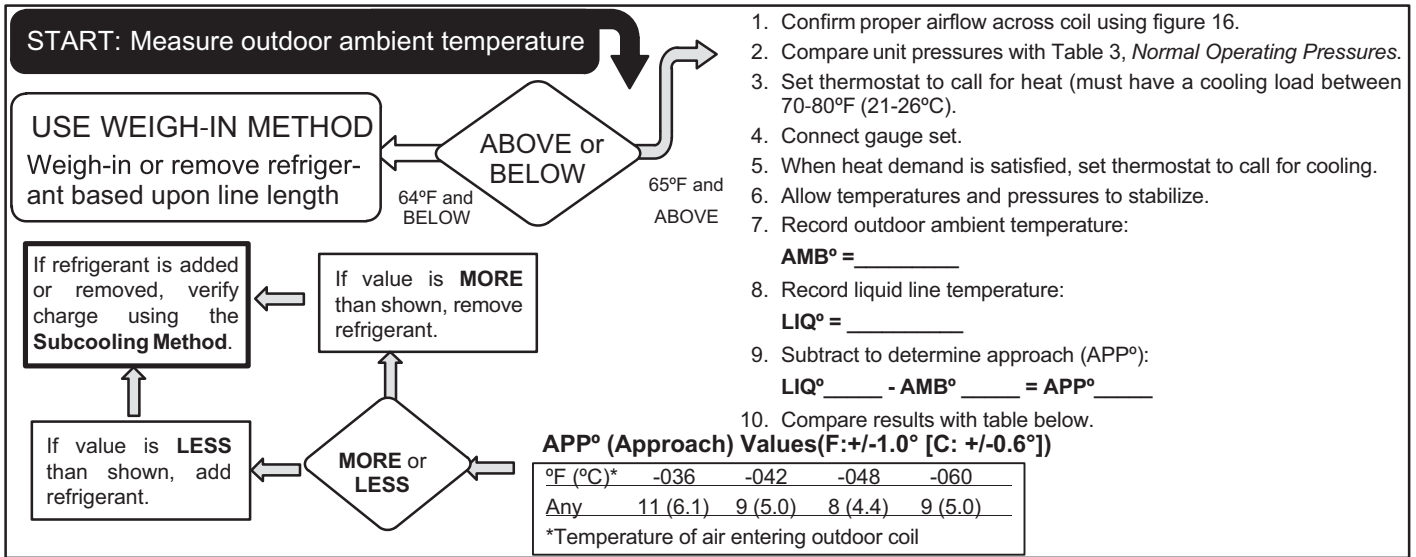

FIGURE 18. HFC-410A Approach TXV Charge

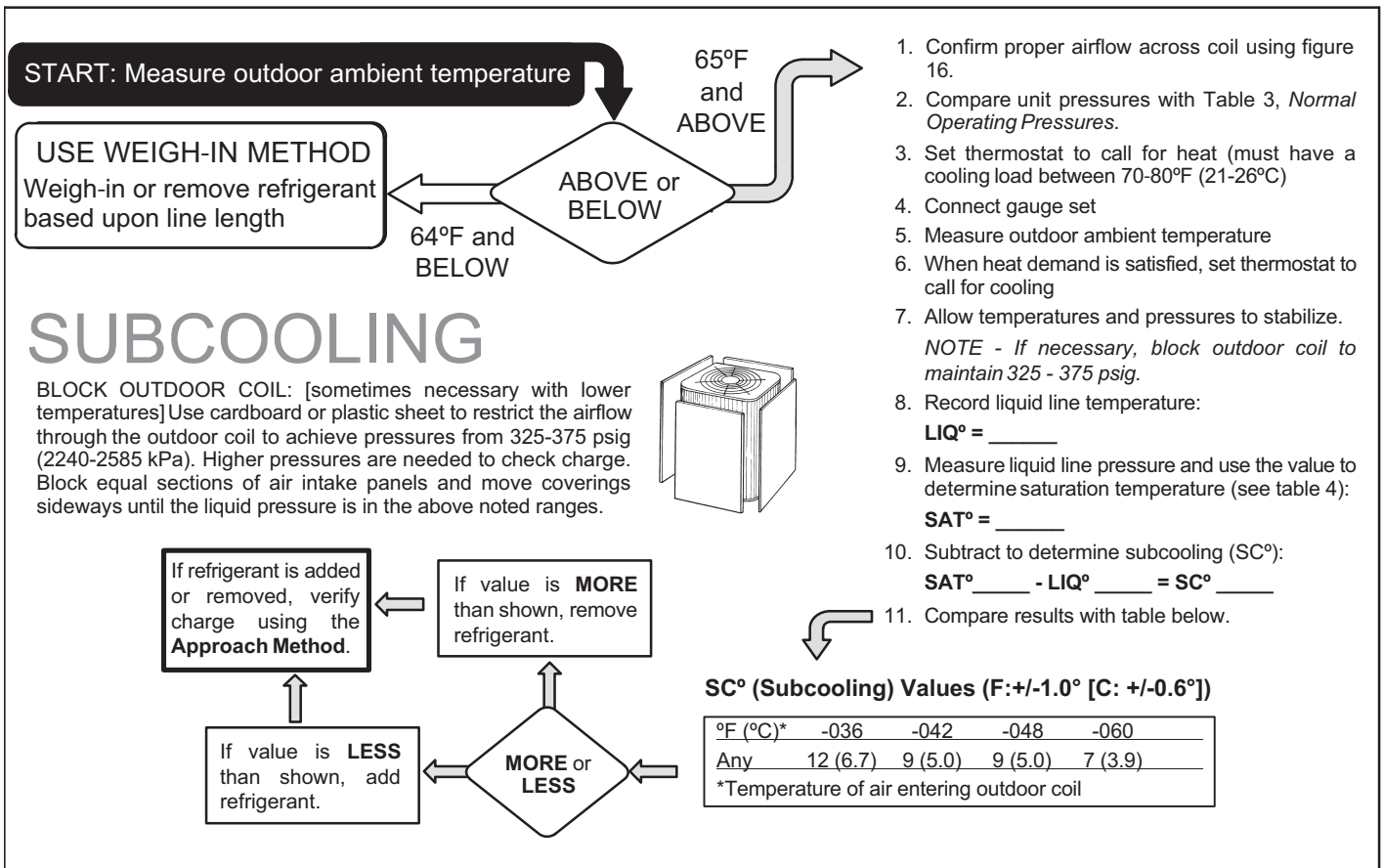

FIGURE 19. HFC-410A Subcooling TXV Charge

TABLE 3. HFC-410A Normal Operating Pressures (Liquid +10 and Suction +5 psig)

<div style="font-size: 2em; font-weight: bold; margin-bottom: 5px;">!</div> <div style="font-size: 1.5em; font-weight: bold; margin-bottom: 5px;">IMPORTANT</div>	<p>Use this table to perform maintenance checks; it is not a procedure for charging the system. Minor variations in these pressures may be due to differences in installations. Significant deviations could mean that the system is not properly charged or that a problem exists with some component in the system.</p>
---	---

ML14XC1	-036	-042	-048	-060
°F (°C)*	Liquid / Suction	Liquid / Suction	Liquid / Suction	Liquid / Suction
Expansion Valve (TXV)				
65 (18)	232 / 138	231 / 132	229 / 139	225 / 123
70 (21)	249 / 140	249 / 132	246 / 140	242 / 125
75 (24)	269 / 141	270 / 133	266 / 141	262 / 127
80 (27)	290 / 142	291 / 134	288 / 142	283 / 129
85 (29)	312 / 143	314 / 135	310 / 144	305 / 131
90 (32)	335 / 144	336 / 136	333 / 145	328 / 133
95 (35)	360 / 145	362 / 137	358 / 146	353 / 135
100 (38)	384 / 146	387 / 138	384 / 147	378 / 137
105 (41)	410 / 148	413 / 140	410 / 148	404 / 139
110 (43)	437 / 149	441 / 142	437 / 150	432 / 140
115 (45)	466 / 150	470 / 144	465 / 151	461 / 142

TABLE 4. HFC-410A Temperature (°F) - Pressure (psig)

°F	°C	Psig	°F	°C	Psig
-40	-40.0	11.6	60	15.6	170
-35	-37.2	14.9	65	18.3	185
-30	-34.4	18.5	70	21.1	201
-25	-31.7	22.5	75	23.9	217
-20	-28.9	26.9	80	26.7	235
-15	-26.1	31.7	85	29.4	254
-10	-23.3	36.8	90	32.2	274
-5	-20.6	42.5	95	35.0	295
0	-17.8	48.6	100	37.8	317
5	-15.0	55.2	105	40.6	340
10	-12.2	62.3	110	43.3	365
15	-9.4	70.0	115	46.1	391
20	-6.7	78.3	120	48.9	418
25	-3.9	87.3	125	51.7	446
30	-1.1	96.8	130	54.4	476
35	1.7	107	135	57.2	507
40	4.4	118	140	60.0	539
45	7.2	130	145	62.8	573
50	10.0	142	150	65.6	608
55	12.8	155			

Maintenance

DEALER

Maintenance and service must be performed by a qualified installer or service agency. At the beginning of each cooling season, the system should be checked as follows:

Outdoor Unit

- 1 - Outdoor unit fan motor is pre-lubricated and sealed. No further lubrication is needed.
- 2 - Visually inspect all connecting lines, joints and coils for evidence of oil leaks.
- 3 - Check all wiring for loose connections.
- 4 - Check for correct voltage at unit (unit operating).

5. Check amp draw on outdoor fan motor.

Motor Nameplate: _____ **Actual:** _____.

6. Inspect drain holes in coil compartment base and clean if necessary.

NOTE – *If insufficient cooling occurs, the unit should be gauged and refrigerant charge should be checked.*

Outdoor Coil

Clean and inspect outdoor coil (may be flushed with a water hose). Ensure power is off before cleaning.

NOTE – *It may be necessary to flush the outdoor coil more frequently if it is exposed to substances which are corrosive or which block airflow across the coil (e.g., pet urine, cottonwood seeds, fertilizers, fluids that may contain high levels of corrosive chemicals such as salts)*

Sea Coast – Moist air in ocean locations can carry salt, which is corrosive to most metal. Units that are located near the ocean require frequent inspections and maintenance. These inspections will determine the necessary need to wash the unit including the outdoor coil. Consult your installing contractor for proper intervals/procedures for your geographic area or service contract.

Indoor Unit

- 1 - Clean or change filters.
- 2 - Lennox blower motors are prelubricated and permanently sealed. No more lubrication is needed.
- 3 - Adjust blower speed for cooling. Measure the pressure drop over the coil to determine the correct blower CFM. Refer to the unit information service manual for pressure drop tables and procedure.
- 4 - Belt Drive Blowers - Check belt for wear and proper tension.
- 5 - 5. Check all wiring for loose connections.
- 6 - Check for correct voltage at unit. (blower operating)
- 7 - Check amp draw on blower motor.

Motor Nameplate: _____ Actual: _____.

Indoor Coil

- 1 - Clean coil if necessary.
- 2 - Check connecting lines, joints and coil for evidence of oil leaks.
- 3 - Check condensate line and clean if necessary.

Homeowner Information

CAUTION

Before attempting to perform any service or maintenance, turn the electrical power to unit OFF at disconnect switch.

In order to ensure peak performance, your system must be properly maintained. Clogged filters and blocked airflow prevent your unit from operating at its most efficient level. The system should be inspected and serviced before each cooling season by a licensed professional HVAC service technician (or equivalent).

Homeowner Maintenance

The following maintenance may be performed by the homeowner.

- Contact a licensed professional HVAC technician to schedule a yearly inspection and maintenance appointment for your equipment.
- Check the indoor unit filter each month and replace the filter, if necessary. Have your Lennox dealer show you where your indoor unit filter is located. It will be either at the indoor unit (installed internal or external to the cabinet) or behind a return air grille in the wall or ceiling. Check the filter monthly and clean or replace it as needed. Disposable filters should be replaced with a filter of the same type and size.

- Check the indoor unit drain line for obstructions monthly during the cooling season. The indoor evaporator coil is equipped with a drain pan to collect condensate formed as your system removes humidity from the inside air. Have your dealer show you the location of the drain line and how to check for obstructions. (This would also apply to an auxiliary drain, if installed.)
- Check the area around the outdoor unit monthly and remove any obstructions that may restrict airflow to the outdoor unit. This would include grass clippings, leaves, or papers that may have settled around the unit. • Trim shrubbery away from the unit and periodically check for debris which collects around the unit.
- During the winter months, keep the snow level below the louvered panels.

NOTE – The filter and all access panels must be in place any time the unit is in operation. If you are unsure about the filter required for your system, call your Lennox dealer for assistance.

IMPORTANT

Sprinklers and soaker hoses should not be installed where they could cause prolonged exposure to the outdoor unit by treated water. Prolonged exposure of the unit to treated water (i.e., sprinkler systems, soakers, waste water, etc.) will corrode the surface of the steel and aluminum parts, diminish performance and affect longevity of the unit.

Thermostat Operation

See the thermostat homeowner manual for instructions on how to operate your thermostat.

Pre-Service Check

If your system fails to operate, check the following before calling for service:

- Verify room thermostat settings are correct.
- Verify that all electrical disconnect switches are ON.
- Check for any blown fuses or tripped circuit breakers.
- Verify unit access panels are in place.
- Verify air filter is clean.

If service is needed, locate and write down the unit model number and have it handy before calling.

Professional Maintenance

Your heating and air conditioning system should be inspected and maintained yearly (before the start of the cooling and heating seasons) by a licensed professional HVAC technician. You can expect the technician to check the following items. **These checks may only be conducted by a licensed professional HVAC technician.**

Outdoor Unit

- 1 - Inspect component wiring for loose, worn or damaged connections. Also check for any rubbing or pinching of wires. Confirm proper voltage plus amperage outdoor unit.

- 2 - Check the cleanliness of outdoor fan and blade assemblies. Check condition of fan blades (cracks). Clean or replace them, if necessary.
- 3 - Inspect base pan drains for debris and clean as necessary.
- 4 - Inspect the condition of refrigerant piping and confirm that pipes are not rubbing copper-to-copper. Also, check the condition of the insulation on the refrigerant lines. Repair, correct, or replace as necessary.
- 5 - Test capacitor. Replace as necessary.
- 6 - Inspect contactor contacts for pitting or burn marks. Replace as necessary.
- 7 - Check outdoor fan motor for worn bearings/bushings. Replace as necessary.
- 8 - Inspect and clean outdoor coils, if necessary and note any damage to coils or signs of leakage.

NOTICE !

Failure to follow instructions will cause damage to the unit.

This unit is equipped with an aluminum coil. Aluminum coils may be damaged by exposure to solutions with a pH below 5 or above 9. The aluminum coil should be cleaned using potable water at a moderate pressure (less than 50psi). If the coil cannot be cleaned using water alone, the manufacturer recommends use of a coil cleaner with a pH in the range of 5 to 9. The coil must be rinsed thoroughly after cleaning.

In coastal areas, the coil should be cleaned with potable water several times per year to avoid corrosive buildup (salt).

Indoor Unit (Air Handler or Furnace)

- 1 - Inspect component wiring for loose, worn or damaged connections. Confirm proper voltage plus amperage of indoor unit.
- 2 - Inspect and clean or replace air filters in indoor unit.
- 3 - Check the cleanliness of indoor blower and clean blower, if necessary.
- 4 - Inspect the indoor coil drain pans and condensate drains for rust, debris, obstructions, leaks or cracks. Pour water in pans to confirm proper drainage from the pan through to the outlet of the pipe. Clean or replace as necessary.
- 5 - Inspect and clean indoor coil, if necessary.
- 6 - Inspect the condition of the refrigerant lines and confirm that pipes are not rubbing copper-to-copper. Also, ensure that refrigerant pipes are not being affected by indoor air contamination. Check condition of insulation on the refrigerant lines. Repair, correct, or replace as necessary.
- 7 - Inspect the duct system for leaks or other problems. Repair or replace as necessary.
- 8 - Check for bearing/bushing wear on indoor blower motor. Replace as necessary.
- 9 - If your heat pump is matched with a gas- or oil-fired furnace for auxiliary heating, indoor unit service will also include inspection and cleaning of the burners, and a full inspection of the gas valve, heat exchanger and flue (exhaust) system.

General System Test with System Operating

- 1 - Your technician should perform a general system test. He will turn on the air conditioner to check operating functions such as the startup and shutoff operation. He will also check for unusual noises or odors, and measure indoor/outdoor temperatures and system pressures as needed. He will check the refrigerant charge per the charging sticker information on the outdoor unit.
- 2 - Verify that system total static pressure and airflow settings are within specific operating parameters.
- 3 - Verify correct temperature drop across indoor coil.

ML14XC1 Start-Up and Performance Checklist

Customer _____ Address _____

Indoor Unit Model _____ Serial _____

Outdoor Unit Model _____ Serial _____

Notes: _____

START UP CHECKS

Refrigerant Type: _____

Rated Load Amps: _____ Actual Amps _____ Rated Volts _____ Actual Volts _____

Condenser Fan Full Load Amps _____ Actual Amps: _____

COOLING MODE

Suction Pressure: _____ Liquid Pressure: _____

Supply Air Temperature: _____ Ambient Temperature: _____ Return Air Temperature: _____

System Refrigerant Charge (Refer to manufacturer's information on unit or installation instructions for required subcooling and approach temperatures.)

Subcooling: _____ A — B = SUBCOOLING
 Saturated Condensing Temperature (A)
 minus Liquid Line Temperature (B)

Approach: _____ A — B = APPROACH
 Liquid Line Temperature (A)
 minus Outdoor Air Temperature (B)

Indoor Coil Temperature Drop (18 to 22°F) _____ A — B = COIL TEMP DROP
 Return Air Temperature (A)
 minus Supply Air Temperature (B)

