



### Features

- 60"L x 36"W x 20"H
- Extra width enhances comfort
- Five adjustable ProFlex® whirlpool jets for maximum bather comfort
- Three-wall alcove installation
- Innovative technology enables this pump to provide a strong, steady level of hydro-massage
- Constructed of acrylic
- Includes integral flange to simplify installation and prevent the possibility of water damage behind the wall
- Textured bottom surface

### Hydrotherapy

- Whirlpool

### Additional Hydrotherapy Options

- Soaking Bath - 1242-L
- Soaking Bath + Bask heated surface - 1242-LW
- BubbleMassage air bath - 1239-GLF
- VibrAcoustic - 1239-VBL
- VibrAcoustic + Bask heated surface - 1239-VBLW
- Whirlpool - 1239-L
- Whirlpool + heater - 1239-LH
- Whirlpool + Bask heated surface - 1239-LW

### Recommended Products/Accessories

K-1278 Removable Apron  
K-7161-AF Bath Drain  
K-24916 Wireless Music Kit  
K-1601 Bath/Whirlpool Footstop  
K-7213 27" Cable Bath Drain  
K-7214 27" Cable Bath Drain  
K-37380 30" Rough-in Cable Bath Drain  
K-37383 30" Rough-in Cable Bath Drain  
K-37386 rough-in cable drain, PVC, 30" cable



### Codes/Standards

ASME A112.19.7/CSA B45.10  
CSA B45.5/IAPMO Z124  
ASTM E162  
ASTM E662  
UL 1795  
Greenguard UL 2818 - Gold





### KOHLER® Plastic Baths and Receptors Lifetime Limited Warranty KOHLER® Hydrotherapy Components Five-Year Limited Warranty

See website for detailed warranty information.

### Available Colors/Finishes

*Color tiles intended for reference only.*

#### Color Code Description

	0	White
	96	Biscuit
	47	Almond
	NY	Dune
	G9	Sandbar

No change in measurements if connected with drain illustrated. (K-7161-AF)

□ Recommended Faucet Location

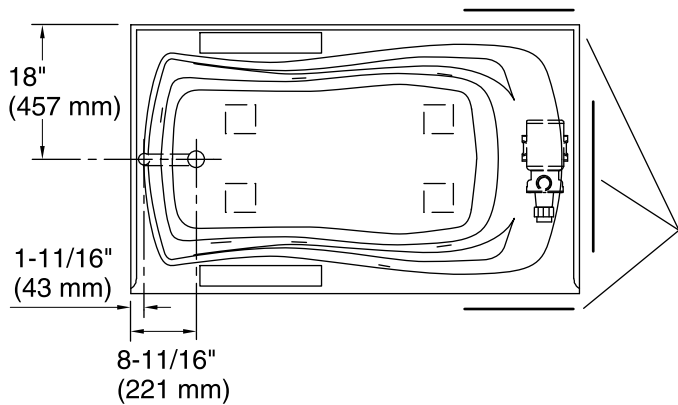

Pump/Control Access  
(If Apron Is Not Used)  
20" (508 mm) W x  
15" (381 mm) H

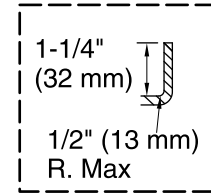

**Integral Flange Detail**

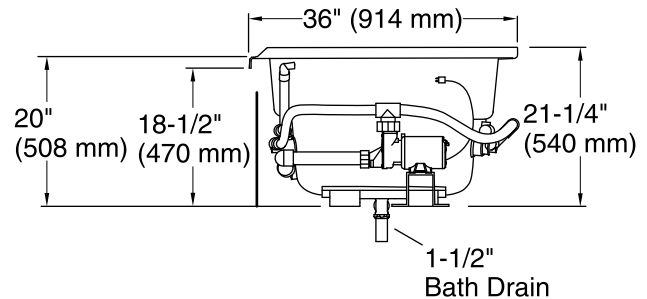
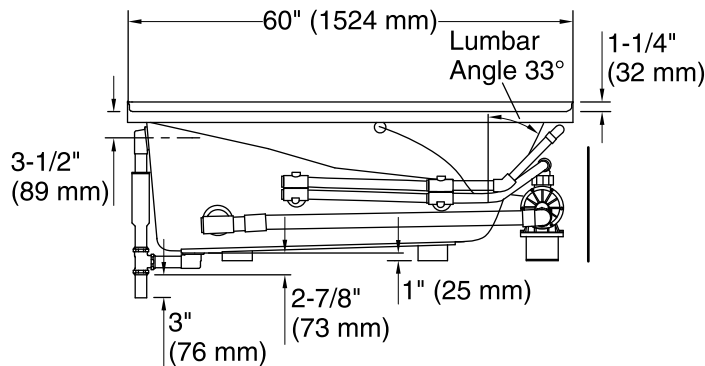

### Required Electrical Service

One dedicated circuit required, protected with Class A Ground-Fault Circuit-Interrupter (GFCI). Outside North America, this device may be known as a Residual Current Device (RCD).

Pump: 120 V, 15 A, 60 Hz

### Technical Information

All product dimensions are nominal.

Installation:	Three-wall alcove
Drain location:	Left
Basin area, bottom:	46" x 24" (1168 mm x 610 mm)
Basin area, top:	54" x 27" (1372 mm x 686 mm)
Weight:	105 lbs (47.6 kg)
Minimum floor load:	44 lbs/ft <sup>2</sup> (214.8 kg/m <sup>2</sup> )
Water depth:	14" (356 mm)
Water capacity:	63 gal (238.5 L)
Electrical component rating:	Pump: 120 V, 7.5 A, 60 Hz
Pump speed:	Single
Minimum flat for door:	2" (50 mm)

### Notes

Measure your actual product for rough-in details. Install this product according to the installation instructions.

The hot water supply should be 70% of the capacity of the bath or greater. Installations will vary.

Provide one grounded electrical outlet within 24" (610 mm) of each component.

If installing a rim-mount faucet, make sure there is no interference above or below the deck before drilling any holes.