



Experts in water.

DAVEY

APPLICATIONS

Ideal for pumping clean, clear water in such applications as:-

- Homes where the incoming municipal water supply pressure is inadequate
- From underground or surface water supplies
- Automatic water transfer
- Applications where the pump may have an interrupted water supply
- Domestic and light industrial irrigation

WHY CHOOSE THE DAVEY BT Home Pressure System?

WATER PRESSURE SYSTEM

The Davey BT booster pressure system consists of a robust centrifugal pump fitted with the intelligent Davey Torrium®2 water pressure controller to deliver boosted water pressure to your home or other application. Consumers can enjoy strong and seemingly constant water pressure due to Torrium®2's constant flow operation.

Due to large water pathways, Torrium®2 operates with a lower head loss than comparable water pressure controllers to provide superior hydraulic performance with less wasted energy.

TORRIUM®2 CONTROLLER

Pressure Boosting

Torium®2 boosts low or fluctuating mains water pressure to give you strong, even water pressure for your comfort and convenience. Torrium®2 can also pressure boost water from rainwater tanks.

Constant Flow and Even Water Pressure

To prevent annoying fluctuations in water temperature during showers, Torrium®2 uses its intelligence to provide households with constant flow to provide even water pressure. It does this with its innovative pressure and flow sensors to start the pump on a pressure drop and to stop it on low flow (~0.26 gpm). This avoids pump cycling when there is continuing household demand for water.

Quick Cut-in for Even Pressure

To give you strong pressure right from the start, Torrium®2 is designed to cut in quickly when it senses demand for water. It cuts in when the pressure has dropped to 80% of the previous top (shut-off) pressure. Torrium®2 automatically sets this cut-in pressure each time the pump stops. In doing so, Torrium®2 automatically adapts to variations in pump performance or site conditions.

cont. overleaf



Davey® BT with Torrium®2 Home Pressure System

Model Numbers:

BT14-30, BT20-30, BT14-45, BT20-40 & BT30-30

The Davey mains water BT Series pressure boosting system comprises of a robust, compact, centrifugal pump with an intelligent Torrium®2 water pressure controller to supply pressure boosted water with constant flow and even pressure to domestic households. The Torrium®2 incorporates multiple levels of pump and motor protection.



Adaptive Starting

Torrium[®]2 is smart enough to detect the difference between normal water demand and a small leak in the system, such as a dripping faucet or a leaking cistern. For very low flows, Torrium[®]2 automatically adapts to reduce the cut-in pressure, which can be as low as 50% of its last shut-off pressure. This significantly reduces pump cycling to improve consumer satisfaction with the system. If normal flow is required in the house (>0.13gpm), Torrium[®]2 will sense this and revert to normal mode and initiate an immediate pump start.

Easy Status Check

To easily check the system status, Torrium[®]2 has three simple LED indicators.

- Red LED - the system is in standby
- Green LED - the pump is running
- Yellow LED – fault condition

Pressure Indicator Window

To give a quick guide to the system pressure, Torrium[®]2 has a pressure indicator window on the side of the built-in pressure vessel. If the color band (green-amber-red) is mainly green it indicates maximum pressure, whereas mainly red indicates low pressure. This indicator can help to analyze the occurrence of unwanted system leaks. If the color band indicator is moving slowly towards red this signifies a slow drop in pressure and may indicate a small leak.

Greater Hydraulic Performance

To provide more pressure while using less energy, Torrium[®]2 has been designed with larger water pathways to provide low head loss, offering superior hydraulic performance than comparable water pressure controllers.

Greater Reliability

To diminish the likelihood of blockages, Torrium[®]2 is designed with no moving control parts within the water pathways giving greater reliability and performance with varying water quality.

Dry Run Protection & Auto Restart

To protect the pump from damage due to dry running, Torrium[®]2 stops the pump when it detects a loss of prime (no water supply) situation. To reduce system downtime, the Torrium[®]2 waits 5 minutes then goes into auto retry mode, whereby it will restart the pump to see if prime can be re-established automatically. An auto restart occurs at 5 minutes, 30 minutes, 1 hour, 2, 4, 8, 16 and 32 hours. Torrium[®]2 will also restart if it detects flow through the system (e.g. from mains water pressure returning with pressure boosting applications).

Pump Protection – High Water Temperature Cut-out

For added security and longer life, a water over-temperature cut-out provides a second level of protection against closed head operation and repetitive cycling. For water temperatures above 158°F Torrium[®]2 will shut the pump down and the amber LED will be lit. When the water temperature drops to below 140°F, the Torrium[®]2 will allow the pump to restart.

Pump Protection – Excessive Electrical Current

To protect the pump motor, Torrium[®]2 will shut the pump down and indicate a fault if it detects excessive electrical current being drawn. This occurs if the pump motor is subjected to locked rotor or if someone tries to manually override the Torrium[®]2 by continually holding in the prime button.

Corrosion & Scale Resistance

To allow Torrium[®]2 to be used with water of varying quality, its flow sensors are mounted on a high grade stainless steel plate with special anti-scaling electronic action, which only turns the flow sensors on during pump operation.

Extra Draw off Capacity

To accommodate small leaks and to reduce cycling, Torrium[®]2 has an in-built spring loaded accumulator for extra draw off capacity. A spring loaded accumulator means low maintenance as there is no need for a pressure vessel with its regular air charging and checking. However, for increased draw off, an optional small pressure tank, can be mounted on the vertical outlet.

Power Surge Protection for Torrium[®]2

To protect the Torrium[®]2 controller from electrical surges and spikes, thus extending its life, it incorporates a metal oxide varistor (MOV). The status of the MOV can be checked in the viewing window on the back of the Torrium[®]2. The MOV is a sacrificial component and should it be consumed due to repeated power surges or spikes, it will almost always blacken the viewing port. This will indicate a non-warrantable Torrium[®]2 failure.

Ease of Installation

For ease of installation, the outlet plumbing can be connected to either the vertical or the right angle discharge outlet, which can rotate a full 360°. A wrench, sized to fit the coupling, is included in the box.

Power Cable

For easy installation, no hard wiring is needed as Torrium[®]2 comes with a 6 foot power cord with a standard NEMA power plug. USA 120V models are fitted with a standard NEMA 5-15P power plug. USA 240V models are fitted with a standard NEMA 6-15P power plug.

PUMP

- Reliable single stage or multistage impeller design (dependent upon pump model)
- All stainless steel construction for reliability and the ability to pump hot water up to 176°F
- Carbon/Ceramic mechanical seal for reliable pump operation

MOTOR

- 120/240V, 60Hz, 2 pole (dependant upon pump model)
- Class F insulation
- Higher than normal 130°F ambient temperature rating for longer life and improved tolerance to voltage variations for peace of mind, even on the hottest days.
- Robust TEFC motor constructed from corrosion resistant materials
- IP55 international protection rating for a high level of resistance to dust and dirt entry
- Protected against both high operating temperature and high current draw by a built-in, automatically re-setting, thermal overload
- Permanently split capacitor for reliable starting even in low voltage circumstances
- Motor and pump are designed for frequent starts



OPERATING LIMITS	
Capacities to	45 gpm
Maximum total head to	76 psi
Cut-in pressure – Adapts to 80% of last shut-off head pressure	
Minimum setting	15 psi
Maximum setting	80 psi
Cut-out flow rate	0.26 GPM
Maximum liquid temperate (Torrium [®] 2)	158° F
Maximum ambient temperature (Torrium [®] 2)	120° F
Maximum suction lift	25'
Inlet size (dependant upon pump model)	1" F or 1 1/4" F
Outlet size	1" M
Maximum pump casing pressure	116 psi
Maximum system pressure	100 psi

MATERIALS OF CONSTRUCTION		
Part	Material	
Impellers	304 stainless steel	
Lock nut	304 stainless steel	
Pump casing	304 stainless steel	
Pump backplate	304 stainless steel	
Pump shaft	316 stainless steel	
Neckrings	Teflon	
Seal ring (stationary)	Ceramic	
Seal ring (rotating)	Carbon (synthetic)	
Seal spring	304 stainless steel	
Orings	Nitrile rubber	
Stage body	304 stainless steel	
Torrium [®] 2 check valve	Stem assembly	Nylon
	Spring	304 stainless steel
	Seal	Nitrile
Torrium [®] 2 body	Glass filled nylon	
Priming plug	304 stainless steel	
Motor shell	Marine grade aluminum	
Lantern / DE endshield	Marine grade aluminum	
Shell & lantern bracket finish	Baked polyester	

INSTALLATION AND PRIMING

- On installations with suction lifts a good quality foot valve should be installed
- The system is primed by filling the pump and suction line with water through the priming port, and replacing priming plug prior to switching on
- The PRIME button on the Torrium[®]2 unit should be held in while the pump is establishing prime

ELECTRICAL DATA

Model	BT14-30	BT20-30	BT14-45	BT20-40	BT30-30
Supply voltage/phase	120V/1			220-240V/1	
Supply frequency	60Hz				
Input power (P1) (kW)	0.92	0.98	0.86	1.10	1.44
Output power (P2) (kW)	0.73	0.78	0.68	0.92	1.12
Full load current (A)	7.80	8.20	7.30	4.70	7.00
Locked rotor current (A)	38.00	38.00	38.00	23.00	23.71
Starting	PSC				
Insulation class	Class F				
IP rating	IP55				

HYDRAULIC PERFORMANCE

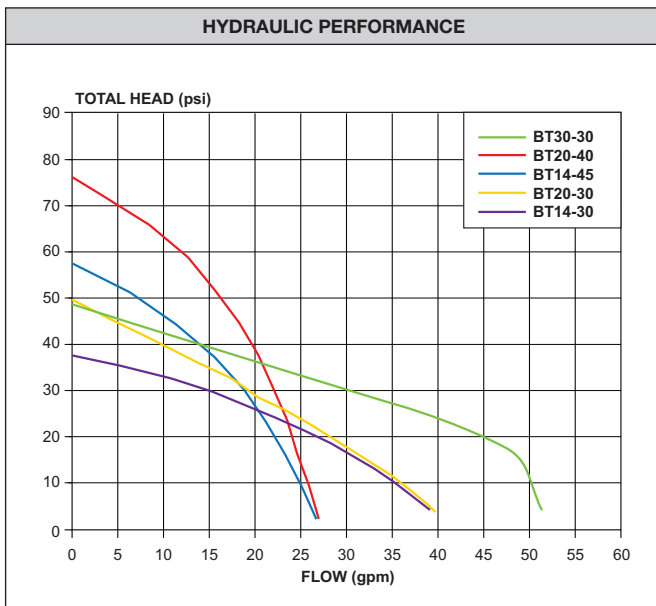

DIMENSIONS (inches)

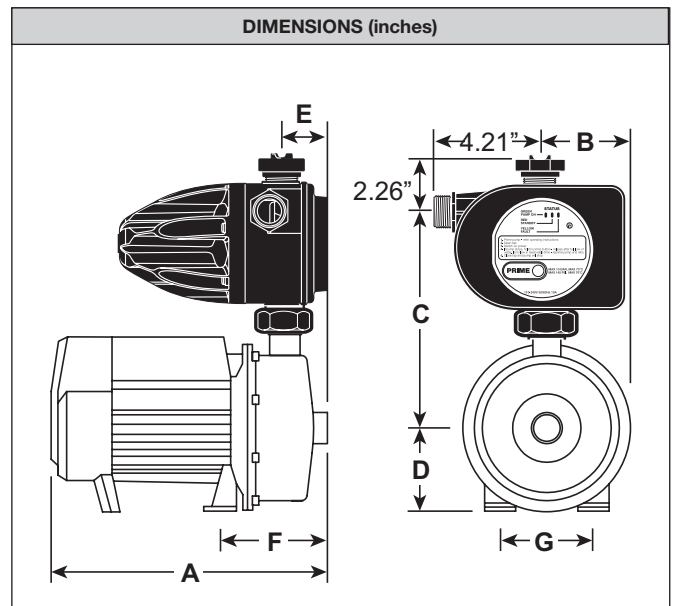

MODEL IDENTIFICATION

B

Booster series
stainless steel
pressure booster pump

T

Torrium®2 equipped





14-30

Flow (gpm) at nominal pressure
14gpm @ 30psi

14-45 = 14gpm @ 45psi
20-30 = 20gpm @ 30psi
20-40 = 20gpm @ 40psi
30-30 = 30gpm @ 30psi

Model	A	B	C	D	E	F	Inlet	Outlet	Net Weight (lbs)	G Hole Diameter @ Centres	
BT14-30	13.80	4.33	12.20	4.33	2.40	5.70	1 1/4" F	1" M	26.50	0.35	4.72
BT20-30	17.40	3.35	8.00	3.54	5.31	8.85	1 1/4" F	1" M	27.30	0.27	3.93
BT14-45	15.35	3.35	8.00	3.54	2.95	6.81	1" F	1" M	25.40	0.27	3.93
BT20-40	17.40	3.35	8.00	3.54	5.31	8.85	1" F	1" M	27.30	0.27	3.93
BT30-30	16.14	4.72	5.67	4.76	2.00	5.83	1 1/4" F	1" M	16.25	0.35	5.51

PERFORMANCE TABLE

BT Home Pressure System	Maximum Inlet Pressure	Maximum Boost	Nominal Flow
BT14-30 	60 psi	40 psi	14 gpm
BT14-45 	40 psi	60 psi	14 gpm
BT20-30 	50 psi	50 psi	20 gpm
BT20-40 	20 psi	80 psi	20 gpm
BT30-30 	50 psi	50 psi	30 gpm

 To make selecting your Davey pressure booster system easier, Davey provide a guide to the number of faucets that can be operated at the same time without substantially reducing performance, assuming an average delivery of three gallons per minute per faucet.

 Indicates that this pump may be suitable for boosting water for watering systems.