

PACKAGED TERMINAL AIR CONDITIONER / HEAT PUMP INSTALLATION INSTRUCTIONS

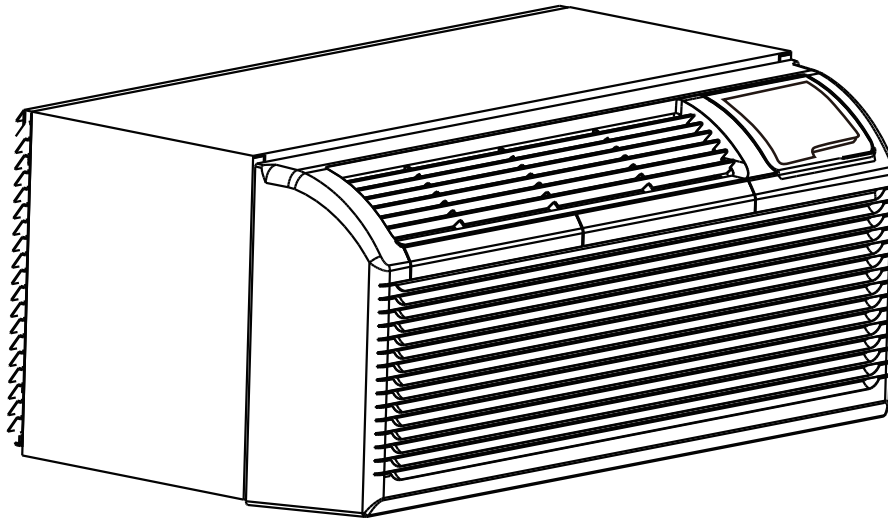

Model:

DCP073A25AA
DCP073A35AA
DCP093A25AA
DCP093A35AA

DCP123A35AA
DCP123A50AA
DCP153A35AA
DCP153A50AA

DHP093A25AA
DHP093A35AA
DHP094A35AA
DHP123A35AA

DHP123A50AA
DHP124A35AA
DHP153A35AA
DHP153A50AA

ATTENTION INSTALLING PERSONNEL

As a professional installer you have an obligation to know the product better than the customer. This includes all safety precautions and related items.

Prior to actual installation, thoroughly familiarize yourself with this Instruction Manual. Pay special attention to all safety warnings.

Often during installation or repair it is possible to place yourself in a position which is more hazardous than when the unit is in operation.

This manual must be left with the owner of the equipment.

Before using your air conditioner, please read this manual carefully and keep it for future reference.



WARNING

Only personnel that have been trained to install, adjust, service or repair (hereinafter, "service") the equipment specified in this manual should service the equipment. The manufacturer will not be responsible for any injury or property damage arising from improper service or service procedures. If you service this unit, you assume responsibility for any injury or property damage which may result. In addition, in jurisdictions that require one or more licenses to service the equipment specified in this manual, only licensed personnel should service the equipment. Improper installation, adjustment, servicing or repair of the equipment specified in this manual, or attempting to install, adjust, service or repair the equipment specified in this manual without proper training may result in product damage, property damage, personal injury or death.



TABLE OF CONTENTS

SAFETY PRECAUTIONS.....	3
IMPORTANT SAFETY INSTRUCTIONS.....	5
OPERATION OF CURRENT DEVICE (OPTIONAL).....	5
AIR CONDITIONER FEATURES.....	6
CONTROL PANEL OPERATION.....	6
DIP SWITCHES CONFIGURATIONS (OPTIONAL).....	8
DIP SWITCHES CONFIGURATIONS BY PANEL.....	10
WALL THERMOSTAT TERMINAL.....	11
INSTALLATION.....	12
CARE AND CLEANING.....	14
TROUBLESHOOTING.....	15

READ THIS MANUAL

Inside you will find many helpful hints on how to use and maintain your air conditioner properly. Just a little preventive care on your part can save you a great deal of time and money over the life of your air conditioner. You'll find many answers to common problems in the chart of troubleshooting tips. If you review our chart of Troubleshooting Tips first, you may not need to call for service at all.

IMPORTANT NOTE TO THE OWNER

This manual is to be used by qualified, professionally trained HVAC technicians only. Goodman does not assume any responsibility for property damage or personal injury for improper service procedures or services performed by an unqualified person.

IMPORTANT NOTES:

Your warranty certificate is also supplied with the unit. Read the warranty carefully and note what is covered. Keep the warranty certificate in a safe place, so you can find it, if necessary.

Before using this manual, check the serial plate for proper model identification.

THE INSTALLATION AND SERVICING OF THIS EQUIPMENT MUST BE PERFORMED BY QUALIFIED, EXPERIENCED TECHNICIANS ONLY.

Due to policy of continual product improvement, the right is reserved to change specifications and design without notice.

Remember, it is your responsibility to install the product safely and to know it well enough to be able to instruct a customer in its safe use.

Safety is a matter of common sense...a matter of thinking before acting. Most dealers have a list of specific good safety practices...follow them.

The precautions listed in this Installation Manual are intended as supplemental to existing practices. However, if there is a direct conflict between existing practices and the content of this manual, the precautions listed here take precedence.



CAUTION

THIS APPLIANCE CAN BE USED BY CHILDREN AGED FROM 8 YEARS AND ABOVE AND PERSONS WITH REDUCED PHYSICAL, SENSORY OR MENTAL CAPABILITIES, OR LACK OF EXPERIENCE AND KNOWLEDGE IF THEY HAVE BEEN GIVEN SUPERVISION OR INSTRUCTION CONCERNING USE OF THE APPLIANCE IN A SAFE WAY AND UNDERSTAND THE HAZARDS INVOLVED. CHILDREN SHALL NOT PLAY WITH THE APPLIANCE. CLEANING AND USER MAINTENANCE SHALL NOT BE MADE BY CHILDREN WITHOUT SUPERVISION (THIS IS APPLICABLE FOR EUROPEAN COUNTRIES).



CAUTION

THIS APPLIANCE IS NOT INTENDED FOR USE BY PERSONS (INCLUDING CHILDREN) WITH REDUCED PHYSICAL, SENSORY OR MENTAL CAPABILITIES OR LACK OF EXPERIENCE AND KNOWLEDGE, UNLESS THEY HAVE BEEN GIVEN SUPERVISION OR INSTRUCTION CONCERNING USE OF THE APPLIANCE BY A PERSON RESPONSIBLE FOR THEIR SAFETY (THIS IS APPLICABLE FOR OTHER COUNTRIES EXCEPT THE EUROPEAN COUNTRIES).



CAUTION

CHILDREN SHOULD BE SUPERVISED TO ENSURE THAT THEY DO NOT PLAY WITH THE APPLIANCE.



CAUTION

THIS APPLIANCE IS NOT INTENDED FOR USE BY PERSONS (INCLUDING CHILDREN) WITH REDUCED PHYSICAL, SENSORY OR MENTAL CAPABILITIES OR LACK OF EXPERIENCE AND KNOWLEDGE, UNLESS THEY HAVE BEEN GIVEN SUPERVISION OR INSTRUCTION CONCERNING USE OF THE APPLIANCE BY A PERSON RESPONSIBLE FOR THEIR SAFETY (THIS IS APPLICABLE FOR OTHER COUNTRIES EXCEPT THE EUROPEAN COUNTRIES).



CAUTION

IF THE SUPPLY CORD IS DAMAGED, IT MUST BE REPLACED BY THE MANUFACTURER, ITS SERVICE AGENT, OR SIMILARLY QUALIFIED PERSONS IN ORDER TO AVOID A HAZARD.



CAUTION

THE APPLIANCE SHALL BE INSTALLED IN ACCORDANCE WITH NATIONAL WIRING REGULATIONS.

 CAUTION
DO NOT OPERATE YOUR AIR CONDITIONER IN A WET ROOM SUCH AS A BATHROOM OR LAUNDRY ROOM.

 CAUTION
THE APPLIANCE WITH AN ELECTRIC HEATER SHALL HAVE AT LEAST 1 METER OF SPACE TO THE COMBUSTIBLE MATERIALS.

 CAUTION
CONTACT THE AUTHORIZED SERVICE TECHNICIAN FOR REPAIR OR MAINTENANCE OF THIS UNIT.

 CAUTION
CONTACT THE AUTHORIZED INSTALLER FOR INSTALLATION OF THIS UNIT.

 CAUTION
IF THE AIR CONDITIONER IS KNOCKED OVER DURING USE, TURN OFF THE UNIT AND UNPLUG IT FROM THE MAIN POWER SUPPLY IMMEDIATELY. VISUALLY INSPECT THE UNIT TO ENSURE THERE IS NO DAMAGE. IF YOU SUSPECT THE UNIT HAS BEEN DAMAGED, CONTACT A TECHNICIAN OR CUSTOMER SERVICE FOR ASSISTANCE.

 CAUTION
IN A THUNDERSTORM, THE POWER MUST BE CUT OFF TO AVOID DAMAGE TO THE MACHINE FROM LIGHTNING.

 CAUTION
TO REDUCE THE RISK OF FIRE OR ELECTRIC SHOCK, DO NOT USE THIS FAN WITH ANY SOLID-STATE SPEED CONTROL DEVICE.

 CAUTION
DO NOT RUN CORD UNDER CARPETING. DO NOT COVER CORD WITH THROW RUGS, RUNNERS, OR SIMILAR COVERINGS. DO NOT ROUTE CORD UNDER FURNITURE OR APPLIANCES. ARRANGE CORD AWAY FROM TRAFFIC AREA AND WHERE IT WILL NOT BE TRIPPED OVER.

SAFETY PRECAUTIONS

To prevent injury to the user or other people and property damage, the following instructions must be followed. Incorrect operation due to ignoring instructions may cause harm or damage. The seriousness of is classified by the following indications:

WARNING

This symbol indicates the possibility of death or serious injury.

CAUTION

This symbol indicates the possibility of injury or damage to property.

 WARNING
PLUG IN POWER PROPERLY. OTHERWISE, IT MAY CAUSE ELECTRIC SHOCK OR FIRE DUE TO EXCESS HEAT GENERATION.

 WARNING
DO NOT OPERATE OR STOP THE UNIT BY INSERTING OR PULLING OUT THE POWER PLUG. IT MAY CAUSE ELECTRIC SHOCK OR FIRE DUE TO HEAT GENERATION.

 WARNING
DO NOT DAMAGE OR USE AN UNSPECIFIED POWER CORD. IT MAY CAUSE ELECTRIC SHOCK OR FIRE. IF THE POWER CORD IS DAMAGED, IT MUST BE REPLACED BY THE MANUFACTURER OR AN AUTHORIZED SERVICE CENTER OR A SIMILARLY QUALIFIED PERSON IN ORDER TO AVOID A HAZARD.

 WARNING
DO NOT MODIFY POWER CORD LENGTH OR SHARE THE OUTLET WITH OTHER APPLIANCES. IT MAY CAUSE ELECTRIC SHOCK OR FIRE DUE TO HEAT GENERATION.

 WARNING
DO NOT OPERATE WITH WET HANDS OR IN DAMP ENVIRONMENT. IT MAY CAUSE ELECTRIC SHOCK.

 WARNING
DO NOT DIRECT AIRFLOW AT ROOM OCCUPANTS ONLY. THIS COULD DAMAGE YOUR HEALTH.



WARNING

ALWAYS ENSURE EFFECTIVE EARTHING. INCORRECT EARTHING MAY CAUSE ELECTRIC SHOCK.



WARNING

DO NOT DISASSEMBLE OR MODIFY UNIT. IT MAY CAUSE FAILURE AND ELECTRIC SHOCK.



WARNING

DO NOT ALLOW WATER TO RUN IN ELECTRIC PARTS. IT MAY CAUSE FAILURE OF MACHINE OR ELECTRIC SHOCK.



CAUTION

WHEN THE AIR FILTER IS TO BE REMOVED, DO NOT TOUCH THE METAL PARTS OF THE UNIT. IT MAY CAUSE AN INJURY.



WARNING

ALWAYS INSTALL CIRCUIT BREAKER AND A DEDICATED POWER CIRCUIT. INCORRECT INSTALLATION MAY CAUSE FIRE AND ELECTRIC SHOCK.



CAUTION

DO NOT CLEAN THE AIR CONDITIONER WITH WATER. WATER MAY ENTER THE UNIT AND DEGRADE THE INSULATION. IT MAY CAUSE AN ELECTRIC SHOCK.



WARNING

DO NOT USE THE SOCKET IF IT IS LOOSE OR DAMAGED. IT MAY CAUSE FIRE AND ELECTRIC SHOCK.



CAUTION

VENTILATE THE ROOM WELL WHEN USED TOGETHER WITH A STOVE, ETC. AN OXYGEN SHORTAGE MAY OCCUR.



WARNING

DO NOT OPEN THE UNIT DURING OPERATION. IT MAY CAUSE ELECTRIC SHOCK.



CAUTION

WHEN THE UNIT IS TO BE CLEANED, SWITCH OFF AND TURN OFF THE CIRCUIT BREAKER. DO NOT CLEAN UNIT WHEN POWER IS ON AS IT MAY CAUSE FIRE AND ELECTRIC SHOCK. IT MAY ALSO CAUSE AN INJURY.



WARNING

KEEP FIREARMS AWAY. IT MAY CAUSE FIRE.



CAUTION

DO NOT PUT A PET OR HOUSE PLANT WHERE IT WILL BE EXPOSED TO DIRECT AIR FLOW. THIS COULD INJURE THE PET OR PLANT.



WARNING

DO NOT USE THE POWER CORD CLOSE TO HEATING APPLIANCES. IT MAY CAUSE FIRE AND ELECTRIC SHOCK.



CAUTION

DO NOT USE FOR SPECIAL PURPOSES. DO NOT USE THIS AIR CONDITIONER TO PRESERVE PRECISION DEVICES, FOOD, PETS, PLANTS, AND ART OBJECTS. IT MAY CAUSE DETERIORATION OF QUALITY, ETC.



WARNING

DO NOT USE THE POWER CORD NEAR FLAMMABLE GAS OR COMBUSTIBLES, SUCH AS GASOLINE, BENZENE, THINNER, ETC. IT MAY CAUSE AN EXPLOSION OR FIRE.



CAUTION

HOLD THE PLUG BY THE HEAD OF THE POWER PLUG WHEN TAKING IT OUT. IT MAY CAUSE ELECTRIC SHOCK AND DAMAGE.



WARNING

VENTILATE ROOM BEFORE OPERATING AIR CONDITIONER IF THERE IS A GAS LEAKAGE FROM ANOTHER APPLIANCE. IT MAY CAUSE EXPLOSION, FIRE, AND BURNS.



CAUTION

TURN OFF THE MAIN POWER SWITCH WHEN NOT USING THE UNIT FOR A LONG TIME. IT MAY CAUSE FAILURE OF PRODUCT OR FIRE.



CAUTION

ALWAYS INSERT THE FILTERS SECURELY. CLEAN FILTER ONCE EVERY TWO WEEKS. OPERATION WITHOUT FILTERS MAY CAUSE FAILURE.



CAUTION

DO NOT USE STRONG DETERGENT SUCH AS WAX OR THINNER BUT USE A SOFT CLOTH. APPEARANCE MAY BE DETERIORATED DUE TO CHANGE OF PRODUCT COLOR OR SCRATCHING OF ITS SURFACE.



CAUTION

DO NOT PLACE A HEAVY OBJECT ON THE POWER CORD AND ENSURE THAT THE CORD IS NOT COMPRESSED. THERE IS A DANGER OF FIRE OR ELECTRIC SHOCK.



CAUTION

DO NOT DRINK WATER DRAINED FROM THE AIR CONDITIONER. IT CONTAINS CONTAMINANTS AND COULD MAKE YOU SICK.



CAUTION

USE CAUTION WHEN UNPACKING AND INSTALLING. SHARP EDGES COULD CAUSE INJURY.



CAUTION

IF WATER ENTERS THE UNIT, TURN THE UNIT OFF AT THE POWER OUTLET AND SWITCH OFF THE CIRCUIT BREAKER. ISOLATE SUPPLY BY TAKING THE POWER-PLUG OUT AND CONTACT A QUALIFIED SERVICE TECHNICIAN.



CAUTION

CLEAN THE EVAPORATOR ONCE EVERY THREE MONTHS BY PROFESSIONAL PEOPLE. OTHERWISE IT MAY CAUSE FAILURE OF ELECTRIC HEATING FEATURE.

IMPORTANT SAFETY INSTRUCTIONS

NOTE: THE POWER SUPPLY CORD WITH THIS AIR CONDITIONER CONTAINS A CURRENT DETECTION DEVICE DESIGNED TO REDUCE THE RISK OF FIRE. PLEASE REFER TO THE SECTION "OPERATION OF CURRENT DEVICE" FOR DETAILS. IN THE EVENT THAT THE POWER SUPPLY CORD IS DAMAGED, IT CANNOT BE REPAIRED. IT MUST BE REPLACED WITH A CORD FROM THE PRODUCT MANUFACTURER.

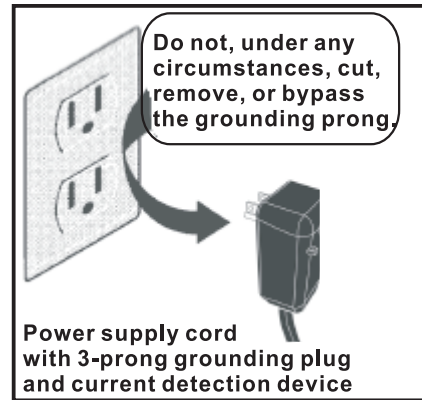

FOR YOUR SAFETY

Do not store or use gasoline or other flammable vapors and liquids in the vicinity of this or any other appliance. Avoid fire hazard or electric shock. Do not use an extension cord or an adapter plug. Do not remove any prong from the power cord.

ELECTRICAL INFORMATION

Be sure the electrical service is adequate for the model you have chosen. This information can be found on the serial plate, which is located on the side of the cabinet and behind the grille. Be sure the air conditioner is properly grounded. To minimize shock and fire hazards, proper grounding is important. The power cord is equipped with a three-prong grounding plug for protection against shock hazards. Your air conditioner must be used in a properly grounded wall receptacle. If the wall receptacle you intend to use is not adequately grounded or protected by a time delay fuse or circuit breaker, have a qualified electrician install the proper receptacle. Ensure the receptacle is accessible after the unit installation. Do not run air conditioner without side protective cover in place. This could result in mechanical damage within the air conditioner. The appliance shall be installed in accordance with national wiring regulations. Do not use an extension cord or an adapter plug.

OPERATION OF CURRENT DEVICE (OPTIONAL)

The power supply cord contains a current device that senses damage to the power cord. To test your supply cord, do the following:

1. Plug in the Air Conditioner.
2. The power supply cord will have TWO buttons on the plug head.
3. Press the TEST button, you will notice a click as the RESET button pops out. Press the RESET button, again you will notice a click as the button engages.
4. The power supply cord is now supplying electricity to the unit. (On some products this it also indicated by a light on the plug head.)

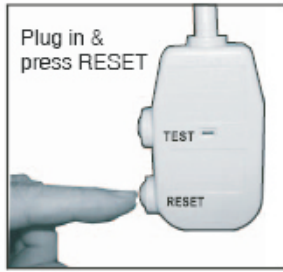

NOTE: Some plugs have buttons on the top.

NOTE: Do NOT USE THIS DEVICE TO TURN THE UNIT ON OR OFF. ALWAYS MAKE SURE THE RESET BUTTON IS PUSHED IN FOR CORRECT OPERATION.

NOTE: THE POWER SUPPLY MUST BE REPLACED IF IT FAILS RESET WHEN EITHER THE TEST BUTTON IS PUSHED, OR IT CANNOT BE RESET. A NEW ONE CAN BE OBTAINED FROM THE PRODUCT MANUFACTURER. IF POWER SUPPLY CORD IS DAMAGED, IT CANNOT BE REPAIRED. IT MUST BE REPLACED BY ONE OBTAINED FROM THE PRODUCT MANUFACTURER.

NOTE: WHEN 265V UNITS ARE TO BE INSTALLED, THE POWER SUPPLY MUST BE PERMANENT WIRING. PERMANENT WIRING MAY BE DONE THROUGH THE ACCESSORY SUBBASE. AN EXPOSED CORD CONNECTION ON 265V UNITS ARE NOT PERMITTED.

AIR CONDITIONER FEATURES

This unit has many features. The servicer must be familiar with these features in order to properly service the unit.

COMPRESSOR RESTART DELAY

This feature extends the overall life of compressor by preventing the short-cycling of the air conditioner. When the compressor restarts, the unit is designed to give a minimum of three minutes to have a time of equalizing the refrigerant pressures for optimizing cycling.

MEMORY

The unit has memory. If power is lost, all of the control settings (mode, fan speed, on / off and configuration) are remembered. When power is restored, the unit will start back up in the mode (and configuration) it was in when power was lost.

AUTOMATIC EVAPORATOR FREEZE PROTECTION

The compressor is turned off automatically to keep the evaporator from freezing and the indoor fan is turned on when the evaporator temperature is too low. If the evaporator temperature is not too low, this function is turned off.

AUTOMATIC QUICK WARM-UP (FOR HEAT PUMP MODELS ONLY)

If the room temperature falls 4.5°C / 8°F below the set point temperature, the reverse cycle heat is shut off, and the electric strip heat is turned on for one cycle until heating is satisfied.

LED INDICATORS AND BUTTONS

The touch pad has buttons for MODE, FAN, POWER, SET POINT UP and SET POINT DOWN. It also has LEDs that correspond to the mode, fan speed, power and set point operation to indicate the unit's status. LEDs for HIGH, MED, and LOW indicate the fan speed that is selected. LEDs for FAN, COOL, and HEAT indicate what operating mode is active. LED for POWER is the unit ON / OFF status LED. If the unit is in ON mode, the LED will be green. If the unit is OFF, the LED will be off.

NOTE: HEAT MODE IS FOR COOLING & HEATING MODELS ONLY.

HIGH TEMPERATURE PROTECTION IN HEATING OPERATION

The compressor and / or electric heater will be switched off to prevent damage in high indoor blow air temperature or error indoor temperature sensor.

UNIT CONFIGURATION °F OR °C

The unit can display in either °F or °C.

Power Card						
Power Supply	230V,15A	230V,20A	230V,30A	265V,15A	265V,20A	265V,30A

NOTE: The shape may be different according to its model.

CONTROL PANEL OPERATION

The control panel keypad will look like the following Figure 1.

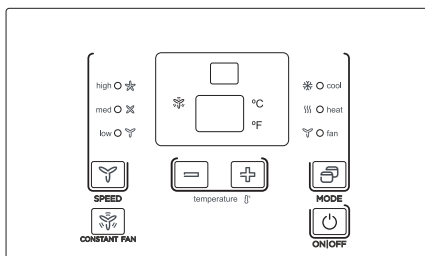

Figure 1

POWER

Press the POWER button to turn the unit on or off.

MODE

Push this button to cycle through the modes from COOL-HEAT-FAN-COOL. The indicator light beside the “MODE” option will illuminate, identifying the mode selected.

COOL: Cooling begins automatically when the room temperature is above the set point and stops when the room temperature is 2°C(4°F) below the set point. But the compressor will run 5 minutes at least in COOL mode before stopping.

HEAT: The maximum temperature can be set up to 29°C / 84°F. For heat pump models, the unit can alternate to run between in reverse cycle heat mode and electric heater mode according to the difference between the setting temperature and the room temperature. The fan motor cycles with the compressor stop.

NOTE: THE REVERSE CYCLE AND ELECTRIC HEATER CANNOT BE RUN AT THE SAME TIME. IN FOLLOWING CASES, IT IS NORMAL THAT THE REVERSE CYCLE DOES NOT OPERATE.

1. When the outdoor temperature is lower than 4°C / 40°F or the room temperature falls to 4.5°C / 8°F below the set point temperature.

2. There is a 3-minute minimum compressor run time at any setting to prevent short cycling. The indoor fan motors starts before the compressor and stops after the compressor cycles off.
3. Push the S1 on the DIP SWITCHES to UP (ON) position.
4. When frost builds up to the evaporator coils, the unit will defrost automatically and the compressor will cycle off.

FAN: Fan operation only without heating and cooling.

NOTE: IF THE UNIT HAS DIP SWITCHES FEATURE, THE TEMPERATURE RANGE CAN BE SET. SEE DIP SWITCHES CONFIGURATIONS ON PAGE 8 FOR DETAILS.

UP / DOWN BUTTONS (+ / -)

Push the UP (or DOWN) button to increase (or decrease) the set temperature of the unit in cooling or heating mode. The temperature can be set by increments of 1°C (1°F). The setting temperature appears in the display.

NOTE: PRESS AND HOLD “+” AND “-” BUTTONS TOGETHER FOR 3 SECONDS WILL ALTERNATE THE TEMPERATURE DISPLAY BETWEEN “°C” & “°F” SCALE.

FAN (FAN SPEED)

Every time you push this button, the fan speed cycles through the settings as follows: HIGH-MED-LOW- HIGH.

CONSTANT FAN

In cooling mode, press the button to turn on or off the constant fan function. When the function is turned on, the constant fan light will illuminate, identifying the fan continuous run for cooling. When the function is turned off, the constant fan light will go out, identifying the fan cycle run with compressor stop.

NOTE: EVERY TIME THE UNIT IS TURNED ON, THE FUNCTION WILL WORK AS THE DIP SWITCHES CONFIGURATIONS.

DISPLAYS:

Shows the set temperature in °C or °F. While on Fan only mode, it shows the room temperature.

Control Code (on some models):

LC - Pads on the control panel is not available. The unit can be set by using wire controller only.

FC - Pads on the control panel and wire controller are not available. The unit can be set by using FRONT DESK CONTROL only.

Error codes:

AS - Room temperature sensor error;

ES - Evaporator temperature sensor error;

CS - Condenser temperature sensor error;

OS - Outside temperature sensor error;

HS - Exhaust temperature sensor error;

LE - Wire controller error;

NOTE: WHEN ERROR OCCURS, UNPLUG THE UNIT AND PLUG IT BACK IN. IF ERROR REPEATS, CALL FOR SERVICE.

Other Codes:

LO - Room temperature is lower than 0°C / 32°F;

HI - Room temperature is higher than 37°C / 99°F;

FP - Low temp. Protection.

NOTE: ALL THE ILLUSTRATIONS IN THIS MANUAL ARE FOR EXPLANATION PURPOSE ONLY. YOUR AIR CONDITIONER MAY BE SLIGHTLY DIFFERENT. THE ACTUAL SHAPE SHALL PREVAIL.

NOTE: THE AIR CONDITIONER IS DESIGNED TO BE OPERATED UNDER CONDITION AS FOLLOWS:

Cooling Operation	Outdoor Temp:	18 - 43°C / 64 - 109°F (18 - 52°C / 64 - 125°F for special tropical models)
	Indoor Temp:	17 - 32°C / 62 - 90°F
Heating Operation	Outdoor Temp:	-5 - 24°C / 23 - 76°F
	Indoor Temp:	0 - 27°C / 32 - 80°F

NOTE: PERFORMANCE MAY BE REDUCED OUTSIDE OF THESE OPERATING TEMPERATURES.

ACCESSORY



NOTE: WHEN THE UNIT DISPLAYS LC, PADS ON THE CONTROL PANEL IS NOT AVAILABLE. THE UNIT CAN BE SET BY USING WIRE CONTROLLER ONLY. YOU CAN INSTALL THE ACCESSORY ON THE CONTROL PANEL.

NOTE: FOR SOME MODELS, THERE IS CORRESPONDING OPERATION HAPPENED AFTER 3 SECONDS WHEN PRESSING ANY BUTTON.

DIP SWITCHES CONFIGURATIONS (OPTIONAL)

REMOVING THE FRONT PANEL

- Dip switches controls are located behind front panel, through an opening below the control panel. To access, remove front panel. See Figure 2.
- Dip switches are accessible without opening the control box. See Figure 3.
- Unit must be powered OFF to effectively change their status.

DIP SWITCHES CONFIGURATIONS

- See Table 1 and Figure 4 for Dip Switches configurations and functions of each dip switch position.

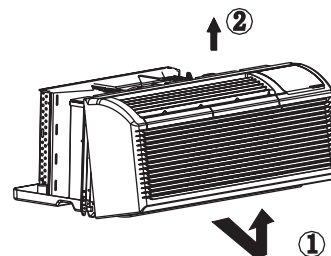

- Pull out at the bottom to release it from the tabs ① .
- Then lift up ② .

Figure 2

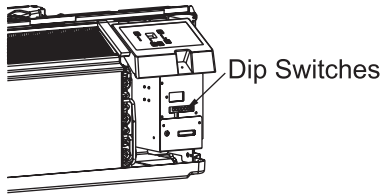

Figure 3

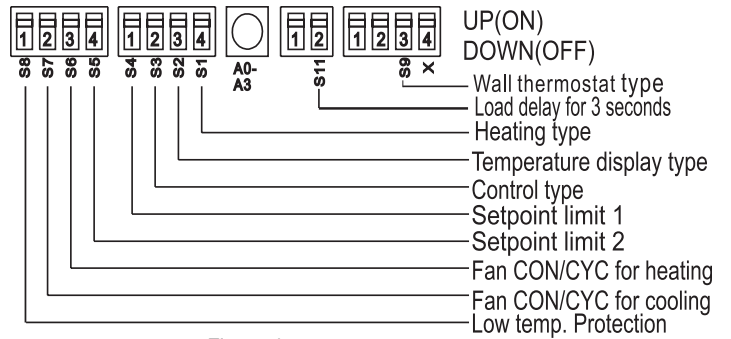

Figure 4

No.	UP (ON)	Down (OFF)	Remarks
S1	Electric Heat Only	Electric Heat and Pump Heat	For Heat Pump unit only
S2	Temperature Display in °F	Temperature Display in °C	
S3	Wall Thermostat Enable	Control Panel Enable	
S4*S5	UP*UP: 61°F - 86°F (16°C - 30°C); UP*DOWN: 65°F - 78°F (17°C - 26°C); DOWN*UP: 63°F - 80°F (17°C - 27°C); DOWN*DOWN: 68°F - 75°F (20°C - 24°C);		Two Configurations (S4*S5) combine to select set point range.
S6	Fan Continuous Run for Heating	Fan Cycle for Heating	
S7	Fan Continuous Run for Cooling	Fan Cycle for Cooling	
S8	Low temp. Protection enable	Low temp. Protection disable	Optional
S9 (S3 UP)	Use some types of wall Thermostat	Use PTAC other wall Thermostat	You can consult with the sales agency or manufacturer for details.
S9 (S3 DOWN)	Use Control Panel Only	Use Control Panel or some types of wall Thermostat	Use Control Panel or some types of wall Thermostat, the other one must be turned off.
Sw11	Load delay for 3 sec.	Normal	Optional

TABLE 1 DIP SWITCH CONFIGURATIONS

NOTE: ON HEATING MODE, THE SETTING TEMPERATURE CAN NOT BE HIGHER THAN 29°C / 84°F.

WALL THERMOSTAT ENABLE

A wired wall thermostat can be connected to the unit. If it is, this dip switch must be moved to the Wall Thermostat Enable Position before the wall thermostat will begin control.

LOW TEMPERATURE PROTECTION (OPTIONAL)

If unit senses a room temperature below 32°F (0°C), the fan motor and electric strip heat will turn on and warm the room to 40°F (4.4°C). The fan stops a short time after the temperature is satisfied.

ELECTRIC HEAT ONLY (FOR HEAT PUMP UNIT ONLY)

This setting is typically used for Emergency Heating.

HEAT AND COOL FAN CON / CYC DIP-SWITCHES

Allows the fan to operate in continuous or cycle modes while the unit is in heating and cooling mode.

CON (CONTINUOUS)

Allows the fan to operate in time after the temperature setting is satisfied. This switch helps to maintain the room temperature closer to the thermostat setting.

CYC (CYCLE)

This setting allows the fan to cycle on and off with the compressor or electric heater. The fan stops a short time after the temperature setting is satisfied.

SET POINT TEMPERATURE LIMITS

Provides a restricted range of temperature control.

DIP SWITCHES CONFIGURATIONS BY PANEL CONTROL (OPTIONAL)

DIP SWITCHES CONFIGURATIONS BY PANEL CONTROL (OPTIONAL)

LED display window High(left) Low(right)

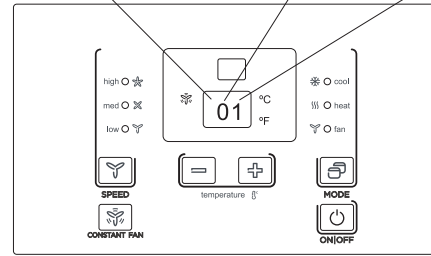

Figure 5

- Turn off the unit.
- Press the up (+) and down (-) buttons together for 3 seconds to activate the dip switches configurations by panel control (see Figure 5).
- See Table 2 for Dip Switches configurations and functions by panel control.
- **NOTE:** Press the up (+) and down (-) buttons together for 3 seconds again or no operation within 30 seconds to exit the dip switches configurations by panel control and the unit will save the last settings.
- Display function settings with 2 digitals in LED display window, high (left) for dip switches, low (right) for functions (see Figure 5).
- Press up (+) button to set the dip switches, press down (-) button to set the functions.

No.	High (left)	Low (Right)		Remarks
/	0	1 - Panel Control	0 - by DIP Switches	
S1	1	1 - Electric Heat Only	0 - Electric Heat and Pump Heat	For Heat Pump Unit Only
S2	2	1 - temperature display in °F	Temperature Display in °C	
S3*S9	3	3 - use control panel or some types of wall thermostat; 2 - use types of wall thermostat; 1 - use PTAC other wall thermostat; 0 - control panel enable.		You can consult with the sales agency or manufacturer for details.
S4*S5	4	4: 62°F - 86°F (17°C - 30°C); 3: 61°F - 86°F (16°C - 30°C); 2: 65°F - 78°F (18°C - 26°C); 1: 63°F - 80°F (17°C - 27°C); 0: 68°F - 75°F (20°C - 24°C);		
S6	6	1 - Fan continuous run for heating	0 - Fan cycle for heating	Not available for "use PTAC other wall thermostat".
S7	7	1 - fan continuous for cooling	0 - Fan cycle for cooling	
S8	8	1 - low. Temp protection enable	0 - low. Temp protection disable	Optional
SW7	A	1 - Front desk control disable	0 - Front desk control enable	Optional
SW11	B	1 - Load delay for three seconds	0 - normal	Optional

TABLE 2 DIP SWITCHES CONFIGURATIONS BY PANEL CONTROL

NOTE:

1. The LED display window will show "00" when you first enter the setting mode, only when you set "01" you can start the next settings.
2. To activate front desk control function, you need to pull the dip switch "SW7" to "DOWN(OFF)", and then set the panel control to "A0".
3. After all set, press up (+) and down (-) buttons together for 3 seconds to exit the operation interface and cut off the power. When re-powered on, the settings are activated.

WALL THERMOSTAT TERMINAL (OPTIONAL)

IMPORTANT: ONLY TRAINED, QUALIFIED PERSONNEL SHOULD ACCESS ELECTRICAL PANEL ON UNIT AND INSTALL ELECTRICAL ACCESSORIES. PLEASE CONTACT YOUR LOCAL ELECTRICAL CONTRACTOR, DEALER, OR DISTRIBUTOR FOR ASSISTANCE.

THERMOSTAT WIRE ROUTING

Thermostat wire is field supplied. Recommended wire gauge is 18 to 20 gauge solid thermostat wire.

NOTE: IT IS RECOMMENDED THAT EXTRA WIRES ARE RUN TO UNIT IN CASE ANY ARE DAMAGED DURING INSTALLATION. THERMOSTAT WIRE SHOULD ALWAYS BE ROUTED AROUND OR UNDER, NEVER THROUGH, THE WALL SLEEVE. THE WIRE SHOULD THEN BE ROUTED BEHIND THE FRONT PANEL TO THE EASILY ACCESSIBLE TERMINAL CONNECTOR.

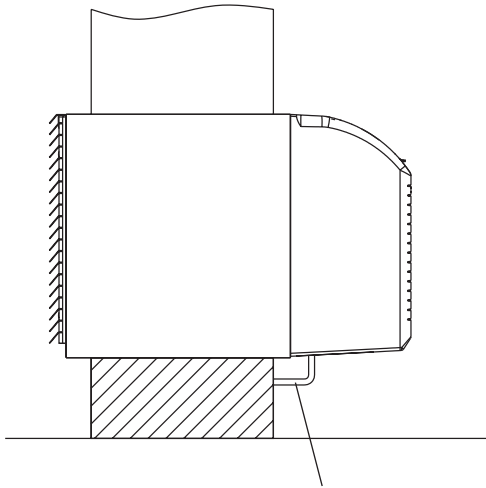

**THERMOSTAT WIRE ROUTING
(UNDER SLEEVE, BEHIND FRONT PANEL)**

Figure A - Proper Wiring Routing Beneath Unit

NOTE: REFER TO THERMOSTAT INSTALLATION INSTRUCTIONS FOR DETAILS ON INSTALLING WALL THERMOSTAT.

INSTALLATION INSTRUCTION OF SOME TYPES OF WALL THERMOSTAT

(You can Consult with the sales agency or manufacturer for details) Pull the dip switch to the DOWN (OFF) position as shown below.

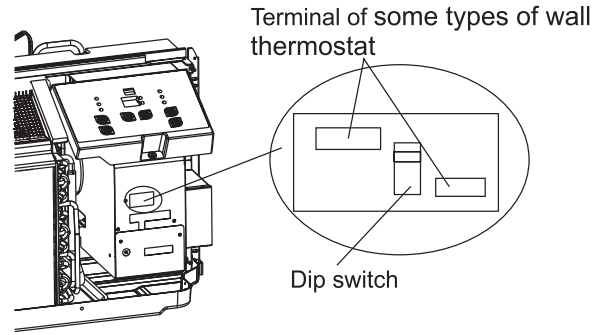
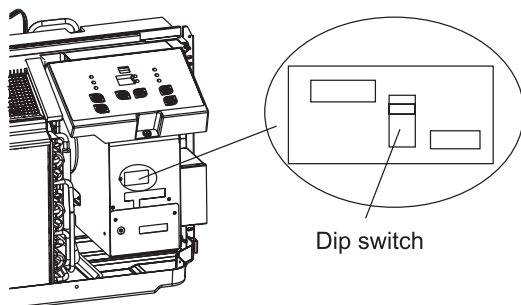

INSTALLATION INSTRUCTION OF PTAC OTHER WALL THERMOSTAT

Remove the two screws as shown below and take the cover panel down.

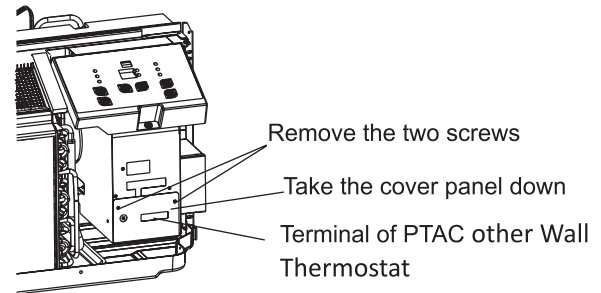

Terminal of PTAC other Wall Thermostat(MODE A)

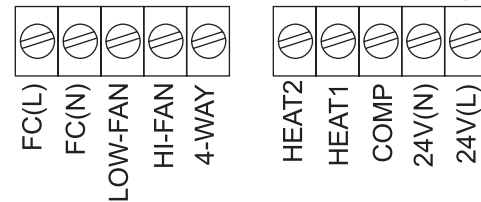

TERMINAL	DESIGNATION
FC(L)	Front desk control terminal L
FC(N)	Front desk control terminal N
LOW-FAN	Low fan speed
HI-FAN	High fan speed
4-WAY	4-way valve; Reverse cycle (Energized in Heat) For heat pump models
HEAT2	Electrical heater 2
HEAT1	Electrical heater 1
COMP	Compressor
24V(N)	24VAC terminal N(Neutral),Common
24V(L)	24VAC terminal L

Insert the wire connector of the wall thermostat into the relevant terminal according to different shapes as shown below.

Terminal of PTAC other Wall Thermostat(MODE B)

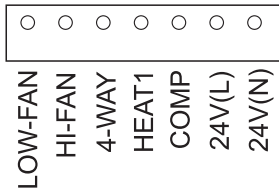

CAUTION

UNIT DAMAGE HAZARD
 FAILURE TO FOLLOW THIS CAUTION MAY RESULT IN EQUIPMENT DAMAGE OR IMPROPER OPERATION. IMPROPER WIRING MAY DAMAGE UNIT ELECTRONICS. COMMON BUSING IS NOT PERMITTED. DAMAGE OR ERRATIC OPERATION MY RESULT.

Use terminal 4-way for heat pump connection only. Suggested set compressor protection time is more than 3 minutes in the wall thermostat. If set less than 3 minutes, the compressor will restart delay 3 minutes still.

Wall Thermostat must be heating changeover 4-way valve. For thermostats that have only one fan speed output (on or auto), the fan speed is determined by how the terminal connector is wired. If Low fan is desired, wire the G output from the thermostat to (LOW-FAN) on the units terminal block. If High fan is desired, wire the G output from the thermostat to (HI-FAN) on the units terminal block.

The range of set temperature of wall thermostat must be in consonance with the range of DIP switch setting. Wall Thermostat must be set the type properly in consonance with the unit type: heat pump or no heat pump.

If the Wall Thermostat has only one electrical heater output, connect the two terminals of HEAT 1 and HEAT 2, the unit can operate two electrical heaters (only for the unit has two electrical heaters). Otherwise operate one electrical heater. Please do not remove the control panel.

FRONT DESK CONTROL

The controller can handle a switch signal from FC(L) and FC(N) input, called front desk control. Input must be 24VAC. If system doesn't receive a 24VAC signal, it will turn unit off; otherwise, the unit runs in normal control. The DIP switch can control the FRONT DESK CONTROL feature. The DIP switch is on the DOWN position, the unit will be turn off; otherwise the unit runs in normal control. See Figure B.

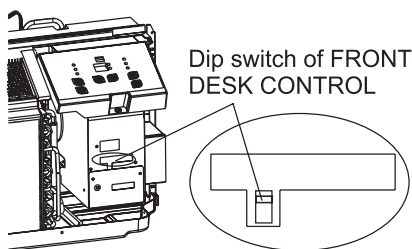

FigB.

INSTALLATION

HOW TO INSTALL THE UNIT:

CAUTION

THERE ARE SHARP EDGES THAT CAN CAUSE SERIOUS CUTS. WHEN LIFTING THE AIR CONDITIONER, IT IS HEAVY. USE TWO PEOPLE TO LIFT.

- For existing sleeve, you should measure the wall sleeve dimensions.
- Install the new air conditioner according to these installation instructions to achieve the best performance. All wall sleeves used to mount the new air conditioner must be in good structural condition and have a rear grille that securely attaches to the sleeve or the flange of the sleeve to secure the new air conditioner.
- To avoid vibration and noise, make sure the unit is installed securely and firmly.
- When installing the sleeve, make certain there is nothing within 20 of the back that would interfere with heat radiation and exhaust air flow. (See Figure 6)

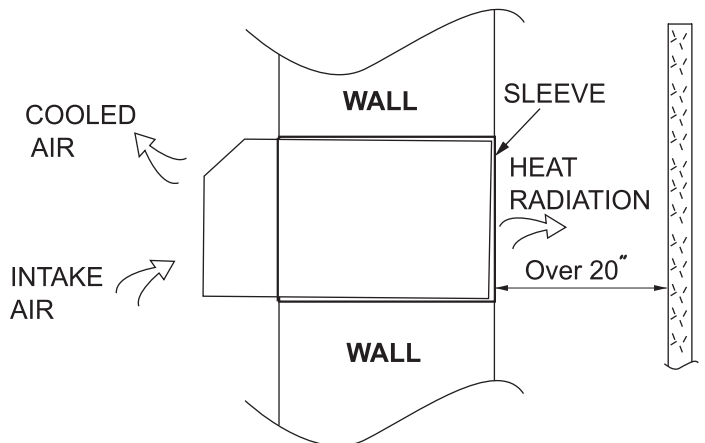

Figure 6

PREPARATION OF SLEEVE ASSEMBLY (OPTIONAL)

Refer to the installation instruction of sleeve assembly for details.

PREPARATION OF REAR GRILL ASSEMBLY (OPTIONAL)

Refer to the installation instruction of rear grille assembly for details.

UNIT INSTALLATION

Carefully remove shipping tapes from the front panel (See Figure 7).

Remove the front panel (See Figure 8).

Remove the shipping screw from the vent door (See Figure 9).

Dimension of air conditioner

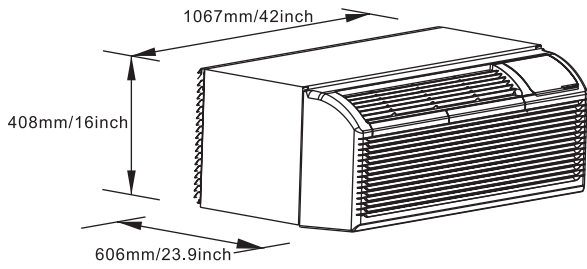

Dimension of sleeve assembly (optional)

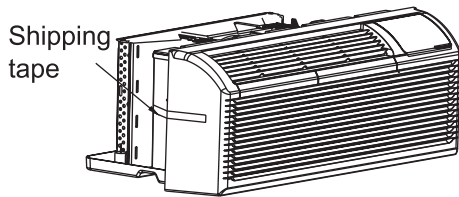
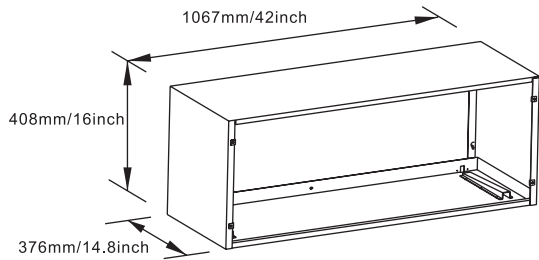
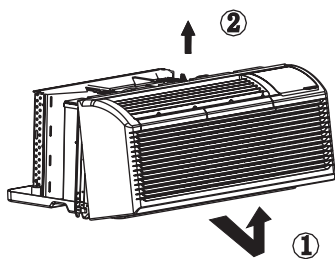

Figure 7



- Pull out at the bottom to release it from the tabs ① .
- Then lift up ② .

Figure 8

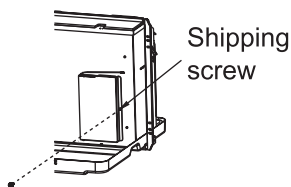

Figure 9

Rotate the vent control lever to either open or close the vent door. (See Figure 10)

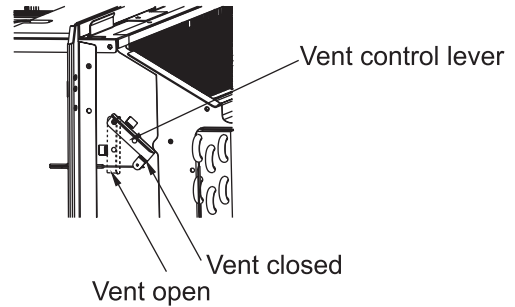

Figure 10

NOTE: WHEN VENT CONTROL LEVER SET AT CLOSE, ONLY THE AIR INSIDE THE ROOM IS CIRCULATED AND FILTERED. WHEN SET AT OPEN, SOME OUTDOOR AIR WILL BE DRAWN INTO ROOM. THIS WILL REDUCE HEATING OR COOLING EFFICIENCY.

Lift unit level and slide unit into wall sleeve until firmly against front of wall sleeve and secure with 4 screws and washers (supplied in the SLEEVE ASSEMBLY) through the unit flange holes. (See Figure 11 and Figure 12)

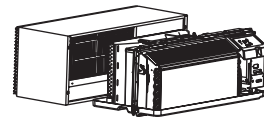

Figure 11

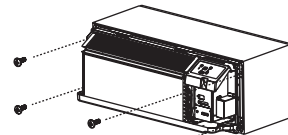
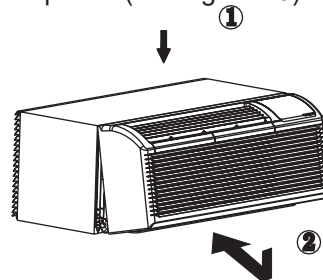

Figure 12

Reinstall from panel. (See figure 13)



- Place tabs over top rail ① . Push Inward at bottom until panel snaps into place ② .

Figure 13

	CAUTION
<p>DO NOT PUT OBSTACLES AROUND AIR-INLET OR INSIDE OF AIR-OUTLET OF THE UNIT SUCH AS WINDOW CURTAIN, ETC.</p>	



CAUTION

ALWAYS INSERT THE FILTER SECURELY, CLEAN FILTER ONCE EVERY TWO WEEKS AS REQUIRED.

CARE AND CLEANING

FRONT PANEL AND CASE

Turn unit off and disconnect power supply. To clean, use water and a mild detergent. DO NOT use bleach and abrasives. Some commercial cleaners may damage the plastic parts.

OUTDOOR COIL

Coil on outdoor side of unit should be checked regularly. Unit will need to be removed to inspect dirt build-up that will occur on the inside of the coil. If clogged with dirt and soot, coil should be professionally cleaned. Clean inside and outside of outdoor coils regularly.

NOTE: NEVER USE A HIGH-PRESSURE SPRAY ON COIL.



CAUTION

UNIT DAMAGE HAZARD

FAILURE TO FOLLOW THIS CAUTION MAY RESULT IN EQUIPMENT DAMAGE OR IMPROPER OPERATION. AIRFLOW RESTRICTION MAY CAUSE DAMAGE TO THE UNIT.

AIR FILTERS

IMPORTANT: TURN UNIT OFF BEFORE CLEANING.



CAUTION

UNIT DAMAGE HAZARD

FAILURE TO FOLLOW THIS CAUTION MAY RESULT IN EQUIPMENT DAMAGE OR IMPROPER OPERATION. DO NOT OPERATE UNIT WITHOUT FILTERS IN PLACE. IF A FILTER BECOMES TORN OR DAMAGED, IT SHOULD BE REPLACED IMMEDIATELY. OPERATING WITHOUT FILTERS IN PLACE OR WITH DAMAGED FILTER WILL ALLOW DIRT AND DUST TO REACH INDOOR COIL AND REDUCE COOLING, HEATING, AIRFLOW AND EFFICIENCY OF UNIT. AIRFLOW RESTRICTION MAY CAUSE DAMAGE TO UNIT.

The most important thing you can do to maintain unit efficiency is to clean the filters once every two weeks as required. Clogged filters reduce cooling, heating, and airflow.

Keeping filters clean will:

- Decrease cost of operation.
- Save energy.
- Prevent clogged indoor coil.
- Reduce risk of premature component failure.

To Clean Air Filters:

- Vacuum off heavy soil.
- Run water through filter.
- Dry thoroughly before replacing.

- Removing Air Filter

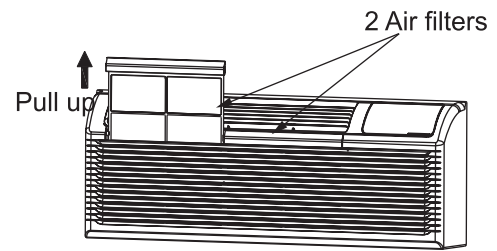

Figure 14

- Replacing Air Filter

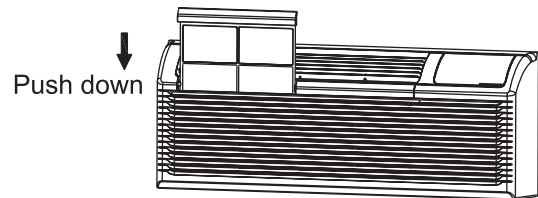

Figure 15

VENT DOOR FILTER

IMPORTANT: TURN UNIT OFF BEFORE CLEANING.

- If the vent door is open, access requires the removal of the unit from the wall sleeve. Clean the vent filter twice a year or as required.
- Make sure to remove the shipping screw from the vent door (See Figure 9).
- Rotate the vent control lever to open the vent door (See Figure 16).
- Remove four screws from the vent door filter (See Figure 16).
- First pull out the vent door steel wire from the hole of the vent door, then take off the vent door and filter (See Figure 16).
- Clean the filter. Dry thoroughly before replacing.
- Replace the vent door and filter, reinstall the four screws.
- Reinsert the vent door steel wire into the hole of the vent door.

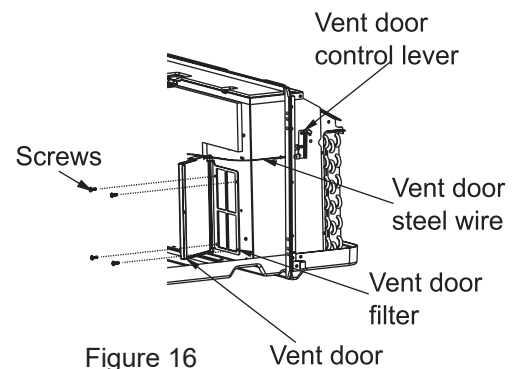

Figure 16

TROUBLESHOOTING

POSSIBLE CAUSES	SOLUTIONS
<p>UNIT DOES NOT START</p> <ul style="list-style-type: none"> · Unit may have become unplugged · Fuse may have blown · Circuit breaker may have been tripped · Unit may be off · Unit may be in a protection mode 	<ul style="list-style-type: none"> · Check that plug is plugged securely in wall receptacle. <p>NOTE: Plug has a test / reset button on it. Make sure that the plug has not tripped.</p> <ul style="list-style-type: none"> · Replace the fuse. See note 1. · Reset circuit breaker. See note 1. · Turn unit on (bottom right button on keypad).
<p>UNIT NOT IN COOLING / HEATING ROOM</p> <ul style="list-style-type: none"> · Unit air discharge section is blocked · Temperature setting is not high or low enough <p>NOTE: Setpoint limits may not allow the unit to heat or cool the room to the temperature desired. Check section on dip switch settings</p> <ul style="list-style-type: none"> · Unit air filters are dirty. · Room is excessively hot or cold when unit is started. · Vent door left open. · Unit may be in protection mode. · Compressor is in time delay. 	<ul style="list-style-type: none"> · Make sure that curtains, blinds, or furniture are not restricting or blocking unit air flow. · Reset to a lower or higher temperature setting. · Remove and clean filters. · Allow sufficient amount of time for unit to heat or cool the room. Start heating or cooling early before outdoor temperature, cooking heat or gatherings of people make room uncomfortable. · Close vent door. · Check dip switch and wall thermostat settings for desired comfort. · Wait approximately 3 minutes for compressor to start.
<p>DISPLAY HAS STRANGE NUMBERS / CHARACTERS ON IT</p>	<ul style="list-style-type: none"> · The unit may be in a protection mode. · The unit may be set for °C (instead of °F).
<p>UNIT MAKING NOISES</p>	<ul style="list-style-type: none"> · Clicking, gurgling, and whooshing noises are normal during operation of unit.
<p>WATER DRIPPING OUTSIDE</p>	<ul style="list-style-type: none"> · If a drain kit has not been installed, condensation runoff during very hot and humid weather is normal. See note 2. If a drain kit has been installed and is connected to a drain system, check gaskets and fittings around drain for leaks and plugs.
<p>WATER DRIPPING INSIDE</p> <ul style="list-style-type: none"> · Wall sleeve is not installed level 	<ul style="list-style-type: none"> · Wall sleeve must be installed level for proper drainage of condensation. Check that installation is level and make any necessary adjustments.

TROUBLESHOOTING

POSSIBLE CAUSES	SOLUTIONS
<p>ICE OR FROST FORMS ON INDOOR COIL</p> <ul style="list-style-type: none"> · Low outdoor temperature · Dirty filters 	<ul style="list-style-type: none"> · When outdoor temperature is approximately 55°F or below, frost may form on the indoor coil when unit is in Cooling Mode. Switch unit to FAN operation until ice or frost melts. · Remove and clean filters
<p>COMPRESSOR PROTECTION</p> <ul style="list-style-type: none"> · Power may have cycled, so compressor is in a restart protection. 	<ul style="list-style-type: none"> · Random Compressor restart - Whenever the unit is plugged in, or power has been restarted, a random restart will occur. After a power outage, the compressor will restart after approximately 3 minutes. · Compressor Protection - To prevent short cycling of the compressor, there is a random startup delay of 3 minutes and a minimum compressor run time of 3 minutes.
<p>ELECTRIC HEATING FAILURE</p>	<ul style="list-style-type: none"> · Clean the evaporator once every three months by professional people.

NOTES:

1. If circuit breaker is tripped or fuse is blown more than once, contact a qualified electrician,
2. If unit is installed where condensation drainage could drip in an undesirable location, an accessory drain kit should be installed and connected to drain system.