

Pre-adjustable filling units

© Copyright 2015 Caleffi

553 Series

Function

The automatic filling valve is a device consisting of a pressure reducing valve with compensating seat, visual system pressure setting indicator, an inlet filter, anti-scale internal parts, a shut-off valve and a check valve.

It is installed on the water inlet piping in sealed heating systems, and its main function is to maintain the pressure of the system stable at a set value, automatically filling up with water as required.

This valve has been designed as pre-adjustable, which means that it can be adjusted at the required pressure value before the system charging phase.

After installation, during the filling or topping-off phase, the water feed will stop when the set pressure is reached filling 50% faster than other valves. There are no levers to flip or valve to close.

Pre-assembled with the 573 series backflow preventer, the AutoFill™ Combo features an atmospheric vent which is designed to protect drinking water systems from return flow, caused by back-siphoning or back pressure, of contaminated fluids. The 573 series has been specifically certified to standards CSA B64.3 and ASSE 1012.

Product Range 553



- 553542A 1/2" M NPT inlet x 1/2" F NPT outlet
- 553549A 1/2" sweat inlet x 1/2" F NPT outlet
- 553642A 1/2" M NPT inlet x 1/2" F NPT outlet / gauge
- 553649A 1/2" sweat inlet x 1/2" F NPT outlet / gauge

Technical Specifications

Filling unit

- Materials**
- body: brass
 - cover: PA 66 GF 30
 - seals: NBR

Performance

- Suitable fluids: water, glycol solution
- Max. percentage of glycol: 50%
- Max. inlet pressure: 230 psi (16 bar)
- Preset outlet pressure: 3–60 psi (0.2–4 bar)
- Factory setting: 15 psi (1.035 bar)
- Indicator accuracy: ±2 psi (±0.15 bar)
- Max. working temperature: 150°F (65°C)
- Pressure gauge scale: 0–60 psi / 0–6 bar

- Connections**
- 553542A 1/2" male NPT inlet x 1/2" female NPT outlet
 - 553549A 1/2" sweat inlet x 1/2" female NPT outlet
 - 553642A 1/2" male NPT inlet x 1/2" female NPT outlet
 - 553649A 1/2" sweat inlet x 1/2" female NPT outlet



SAFETY INSTRUCTION

This safety alert symbol will be used in this manual to draw attention to safety related instructions. When used, the safety alert symbol means **ATTENTION! BECOME ALERT! YOUR SAFETY IS INVOLVED!** FAILURE TO FOLLOW THESE INSTRUCTIONS MAY RESULT IN A SAFETY HAZARD.



CAUTION: All work must be performed by qualified personnel trained in the proper application, installation, and maintenance of systems in accordance with all applicable codes and ordinances.



CAUTION: If the automatic filling unit is not installed, commissioned and maintained properly, according to the instruction contained in the manual, it may not operate correctly and may endanger the user..



CAUTION: Make sure that all the connecting pipework is water tight.



CAUTION: When making the water connections, make sure that the unit connecting pipework is not mechanically over-stressed. Over time this could cause breakages, with consequent water losses which, in turn, could cause harm to property and/or people



CAUTION: In the case of highly aggressive water, arrangements must be made to treat the water before it enters the unit, in accordance with current legislation. Otherwise the unit may be damaged and will not operate correctly.

Leave this manual for the user

Construction details

Pre-calibration

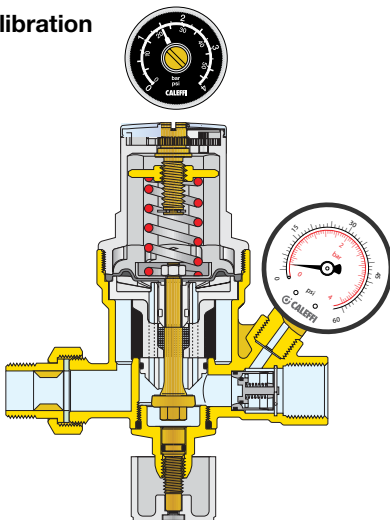

This model is equipped with a pressure setting indicator for the commissioning operation. The system charge pressure can be input by means of the adjusting screw, before the start of the system filling phase.

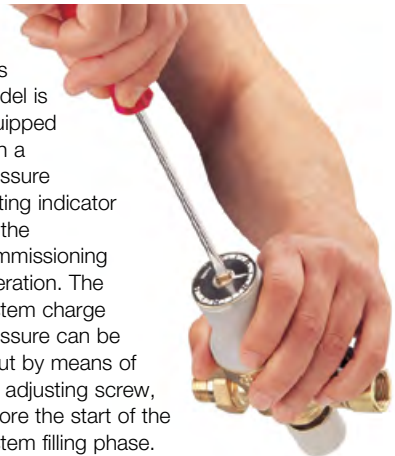

Removable filter cartridge

The cartridge containing the operating mechanisms, protected by a large surface area strainer, is removable. This makes it very easy and quick to carry out inspections, internal cleaning and even replacement of the cartridge itself. Water intake is proportional to the air vented from the system.

Installation

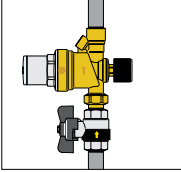

1. Filling unit can be installed in either horizontal or vertical position. It is, however, vital that the unit is not installed upside down.

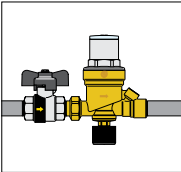

2. The special method of mechanical pre-adjustment with pressure setting indicator makes it possible to set the unit to the required value in the system before the beginning of the filling phase.

3. The unit is normally set at a pressure not less than that obtained by adding the hydrostatic pressure and 4 psi (0,3 bar).

4. During filling, the internal mechanism will automatically regulate the pressure until it reaches the required value, **without the need to oversee the filling operation** itself. This prevents the system being charged to a higher pressure than required.

5. Given the pre-calibrating function, the presence of the downstream pressure gauge is not essential.

6. When the system is filled, the shut-off valve can be closed. In order to restore the automatic topping-off condition, merely re-open the valve. The pressure in the system will gradually return to the set pressure.

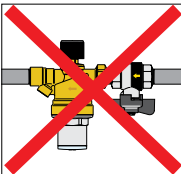

Maintenance

For cleaning, inspection or replacement of the entire cartridge, proceed as follows:

1. Isolate the unit.
2. Open the lower control knob.
3. Unscrew the adjusting screw until it stops.
4. Remove the upper cover.
5. Extract the cartridge using pliers.
6. The entire unit, after inspection, can be reassembled or replaced using a spare cartridge.
7. Re-adjust the equipment.

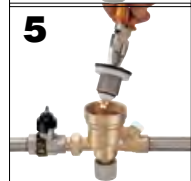
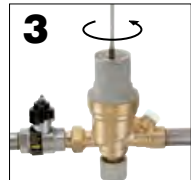
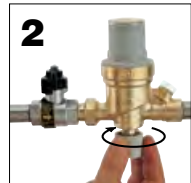

Application diagram

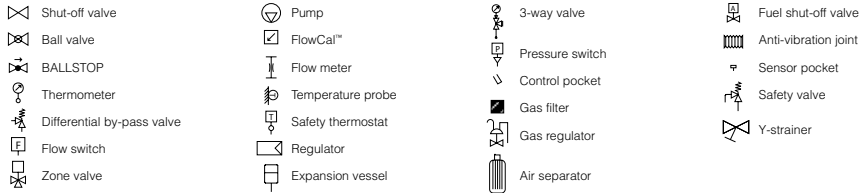
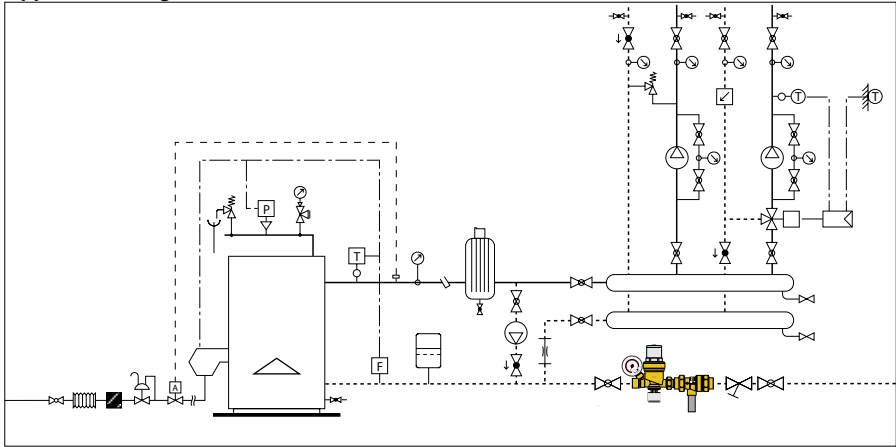

Replacement parts



NA103 Replacement gauge 0–60 psi/0–4 bar, ¼" NPT



F59650 AutoFill™ 553 series replacement cartridge



NA10197 AutoFill™ clear plastic disc cover

CALEFFI
Hydronic Solutions

Caleffi North America, Inc.
3883 West Milwaukee Road
Milwaukee, WI 53208
T: 414.238.2360 F: 414.238.2366

Backflow preventer with intermediate atmospheric vent

© Copyright 2015 Caleffi

573 Series

Installation, commissioning and servicing instructions



Function

The backflow preventer with atmospheric vent is designed to protect drinking water systems from the return, caused by backsiphonage or backpressure, of contaminated fluids.

The Caleffi 573 series is certified by ICC-ES to be in compliance with the International Plumbing Code (IPC), International Residential Code (IRC), Uniform Plumbing Code (UPC), and standards ASSE 1012-2009, and CSA B64.3-94. Additionally, it is also certified by ICC-ES to be in compliance with standard NSF/ANSI 372-2011, Drinking Water System Components – Lead Content Reduction of Lead in Drinking Water Act, California Health and Safety Code 116875 S.3874, Reduction of Lead in Drinking Water Act.



ASSE 1012



Product range

573 series backflow preventer with atmospheric vent
size 1/2" - 3/4" NPT female threaded connection with union
size 1/2" sweat connection with union

Technical characteristics

Connections:	1/2" - 3/4" NPT female with union 1/2" SWT with union
Materials:	Body: low lead brass Filter: stainless steel Check valve: PSU Check valve stem: brass Diaphragm: EPDM Seals: EPDM
Maximum working pressure:	175 psi (12 bar)
Maximum working temperature:	210°F (99°C)
Emergency back pressure temperature:	250°F (121°C)
Medium:	water

Certified to: CSA B64.3-94 and ASSE 1012-2009
NSF/ANSI 372-2011, Drinking Water System Components-Lead Content
Reduction of Lead in Drinking Water Act, California Health and Safety
Code 116875 S.3874, Reduction in Drinking Water Act, certified by
ICC-ES, file PMG-1360.



SAFETY INSTRUCTION / CONSIGNE DE SÉCURITÉ

This safety alert symbol will be used in this manual to draw attention to safety related **instructions**. When used, the safety alert symbol means **ATTENTION! BECOME ALERT! YOUR SAFETY IS INVOLVED! FAILURE TO FOLLOW THESE INSTRUCTIONS MAY RESULT IN A SAFETY HAZARD.**

Ce symbole d'avertissement servira dans ce manuel à attirer l'attention sur la sécurité concernant instructions. Lorsqu'il est utilisé, ce symbole signifie **ATTENTION ! DEVEZ-VOUS ÊTRE ALERTES ! VOTRE SÉCURITÉ EST EN JEU ! NE PAS SUIVRE CES INSTRUCTIONS PEUT PROVOQUER UN RISQUE DE SÉCURITÉ.**



CAUTION: All work must be performed by qualified personnel trained in the proper application, installation, and maintenance of systems in accordance with all applicable codes and ordinances.

ATTENTION: Tous les travaux doivent être effectués par du personnel qualifié formé à la bonne application, installation et maintenance des systèmes conformément aux codes et règlements locaux.



CAUTION: If the backflow preventer is not installed, commissioned and maintained properly, according to the instructions contained in this manual, it may not operate correctly and may endanger the user.

ATTENTION: Si Disconnecteur n'est pas installé, mis en service et entretenu correctement, selon les instructions contenues dans ce manuel, il peut ne pas fonctionner correctement et peut mettre en danger l'utilisateur.



CAUTION: Make sure that all the connecting pipework is water tight.

ATTENTION: S'assurer que tous les raccordements sont étanches.



CAUTION: When making the water connections, make sure that the backflow preventer connecting pipework is not mechanically over-stressed. Over time this could cause breakages, with consequent water losses which, in turn, could cause harm to property and/or people.

ATTENTION: Lorsque vous effectuez les raccordements d'eau, assurez-vous que la tuyauterie reliant disconnecteur n'est pas mécaniquement des overstressed. Au fil du temps, ceci pourrait causer des ruptures, avec pour conséquence des pertes en eau qui, à leur tour, peuvent causer des dommages à la propriété et/ou les gens.



CAUTION: Water temperatures higher than 100°F can be dangerous. During the installation, commissioning and maintenance of the backflow preventer, take the necessary precautions to ensure that such temperatures do not endanger people.

ATTENTION: Les températures de l'eau supérieure à 100°F peut être dangereux. Au cours de l'installation, mise en service et l'entretien de la disconnecteur, prendre les précautions nécessaires afin de s'assurer que de telles températures ne compromettent pas les gens.



CAUTION: In the case of highly aggressive water, arrangements must be made to treat the water before it enters the backflow preventer, in accordance with current legislation. Otherwise the valve may be damaged and will not operate correctly.

ATTENTION: Dans le cas de l'eau fortement agressifs, des dispositions doivent être prises pour traiter l'eau avant qu'elle ne pénètre dans le disconnecteur, conformément à la législation actuelle. Sinon la soupape pourrait être endommagée et ne fonctionnent pas correctement.

**LEAVE THIS MANUAL FOR THE USER
LAISSÉZ CE MANUEL AVEC L'UTILISATEUR**

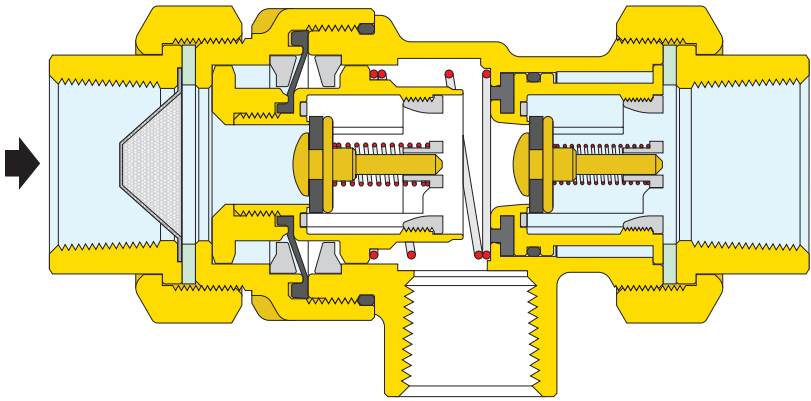

VENT

Flow rate graph

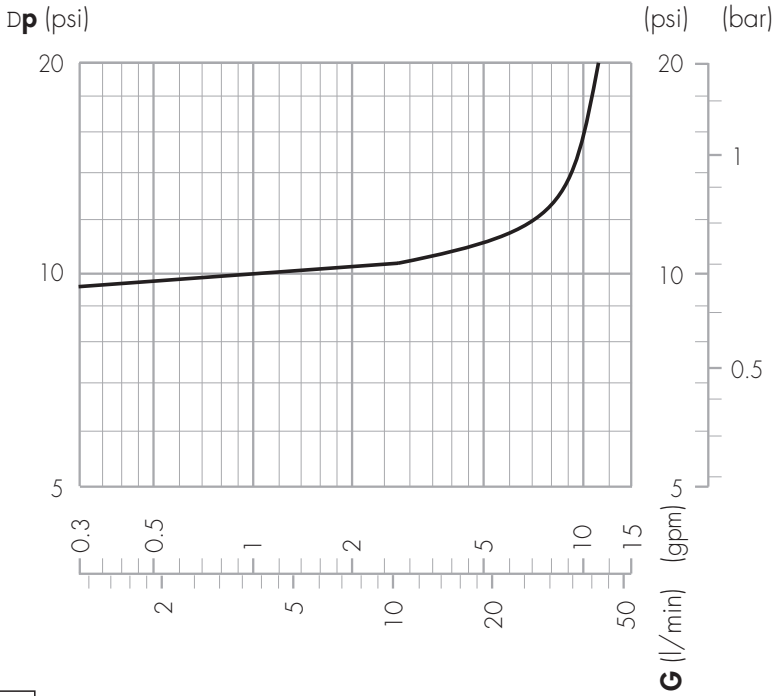

$C_v = 0.7$

Installation

The Caleffi 573 series backflow preventer with atmospheric vent must be installed in accordance with the diagrams contained in this instruction manual taking into account all the applicable Codes and Regulations.

Before installing a Caleffi 573 series backflow preventer, the system must be thoroughly flushed to remove impurities or any debris which may have accumulated during installation. Failure to remove dirt or debris may affect performance and the manufacturer's guarantee.

The Caleffi 573 series backflow preventer must be installed preferably horizontally and following the flow direction indicated by the arrow on the valve body.

The Caleffi 573 series backflow preventer must be installed with one isolating valve and a strainer upstream and one isolating valve downstream.

The Caleffi 573 series backflow preventer must be installed in an accessible location to facilitate testing and servicing.

The Caleffi 573 series backflow preventer must be installed with the vent port connected via an air gap to a discharge line, in accordance with the plumbing code requirements and keeping a minimum distance of 12" from the floor.

Do not install where the discharge can cause damage.

If field testing is required by code, it must be installed in accordance with the relevant diagram in this instruction manual.

Installation diagram

Heating system application

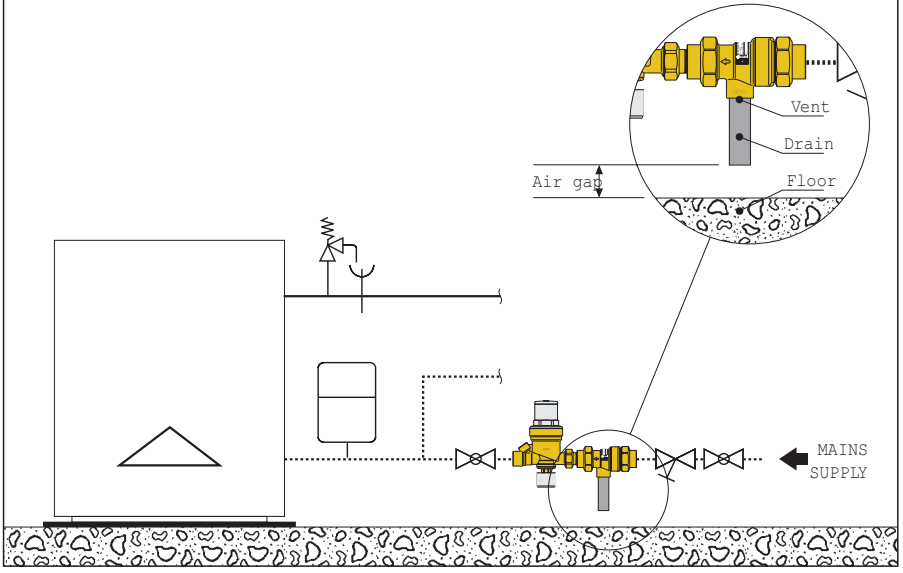

Field testing installation

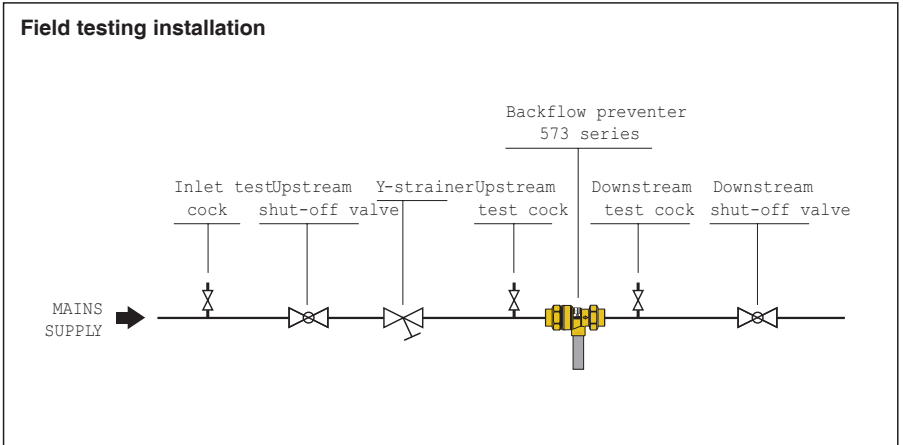

Field testing procedure

1) Check operation of the discharge. When inlet water pressure drops to atmospheric, the valve must open the vent port and discharge the contained amount of water in the valve body.

a. -close shutoff valves upstream and downstream.

b. -open the upstream test cock

The water contained in the body must be discharged, indicating that the diaphragm has opened the vent port.

2) Check for tightness of the internal second check valve. When backpressure is applied to the downstream side of the valve, the internal second check valve must close back drip tight on its seat.

a. -close shutoff valves upstream and downstream.

b. -open the upstream test cock

c. -install a removable bypass hose connecting inlet test cock to downstream test cock and open them for admitting pressure to the downstream side of the internal second check valve
Water must not drip from the vent port indicating that the second check valve is not leaking.

Service

The internal parts of the backflow preventer are replaceable. Spare parts are available upon request.



Caleffi North America, Inc.
3883 West Milwaukee Road
Milwaukee, WI 53208
T: 414.238.2360 F: 414.238.2366