



# SharkBite® 2XL

For Copper, CPVC, or PEX Pipe

## DESCRIPTION

LARGE BORE SharkBite Commercial is an extensive range of SharkBite Fitting and full flow Ball Valves in sizes 1¼", 1½", & 2" Copper Tube Size (CTS) suitable for use with Copper, PEX, (SharkBite Tube Liner must be fitted to the PEX Pipe) and CPVC pipe. Use in commercial and residential applications for potable water, hydronic heating, chilled water and general water distribution for irrigation.

## FEATURES AND BENEFITS

### Quick Connect:

No tools, soldering, clamps, unions or glue required. Cut pipe square, de-burr to remove rough edges/debris, mark the pipe for correct depth and push to get a pressure ready connection every time.

### Quick Disconnect:

Disconnect in seconds by sliding the De-Mount Tool down the pipe to engage the demount lugs and rotate clockwise to lock the open position leaving both hands free, you can now remove the pipe.

### SAFE-Recessed Release Collar:

Commercial SharkBite require a special Demount Tool and cannot be accidentally disconnected/released.

### Extensive Range Including Slip Feature on Couplings and Tee's:

When repairing or tapping into existing pipe with "Push-Fittings" you must be able to either move the fitting or the pipe to ensure the pipe is engaged fully into the fitting. With rigid pipe like copper the only way with "Push-Fittings" is to have a SLIP feature to allow easy installation when tapping into existing pipe.

### Easy Installation:

Unlike the tool intensive connection methods there is NO need to send multiple fitters to a job, SharkBite Commercial has been designed to be installed or removed by one person. All fittings are lubricated for easy connection and by fitting the De-Mount Tool before engaging the pipe the force required can be reduced further.

With the De-Mount Tool locked on you also have hands free disconnection.

WET OR DRY: No waiting for copper tube to dry before soldering or glue to cure, SharkBite makes an instant connection in seconds.

### No Tools:

Unlike alternative tool intensive connections systems, SharkBite has no special tooling required for installation.

### No Time:

Fastest connection - CUT-PUSH-DONE.  
Easy access to small or confined places.  
No Flame - Does not require fire permit or fire marshal.

### No Waste:

Should you make an error or simply want to change your installation, no problem for SharkBite. Simply remove and re-use. (Fittings used for repeated testing must not be used in any permanent application).

### Fittings Cannot be Disassembled:

SharkBite Commercial Fitting are factory assembled and components cannot be removed.

### Long Pipe Engagement:

Provides pipe support against lateral pipe forces.

### Lead Free (LF) Dezincification Resistance (DZR) Brass:

Exceeds current no lead legislation - AB1953 or NSF372. Suitable for underground installation subject to local code authorities/inspectors. Dezincification properties (DZR) exceed ISO6509 and NSF-14.

### Environmentally Friendly:

Remove and re-use fittings, no need to be scrapped.  
No heat is required for installation.

## SPECIFICATION

SharkBite Commercial fittings are designed to operate over a wide range:  
Temperatures from 20°F to 200°F.  
Maximum working pressure of 200psi.

Design for use on ASTM B88 hard drawn & annealed copper type K, L, or M, ASTM F876 & F877 PEX and ASTM D2846/D2846M CPVC water pipe.

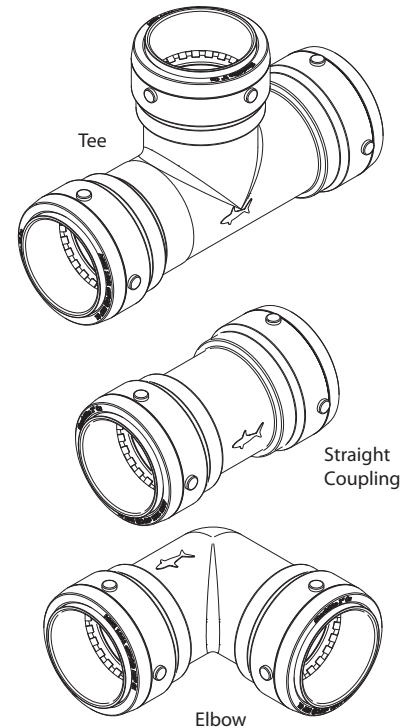



# SharkBite® 2XL

For Copper, CPVC, or PEX Pipe

## SPECIFICATION DATA-FITTINGS

Body..... DZR Brass-Lead Free Alloy.  
 O Ring..... Chloramine Resistant EDPM O-Ring.  
 Tube Liner..... Copper.  
 Grab Ring..... 316 Stainless Steel.  
 SharkBite Cartridge Assembly..... Acetyl Copolymer.

## SPECIFICATION DATA-VALVES

Body..... DZR Brass-Lead Free Alloy.  
 Cap..... DZR Brass-Lead Free Alloy.  
 Ball..... 316 Stainless Steel.  
 Spindle..... DZR Brass-Lead Free.  
 Seat..... PETF.  
 Handle..... Mild Steel.

## CONNECTIONS

Tube Connections..... CTS.  
 Threaded Connections..... Male or Female NPT.  
 Street Connections..... CTS.

## CERTIFICATIONS

IAPMO IGC 157: Ball Valves- This standard covers material, testing, dimensional and performance requirements.  
 ASSE1061: Fittings-Performance requirements for removable & non-removable push-fit fittings.  
 NSF/ ANSI 61, NSF/ANSI 372, ASSE 1061

## TYPICAL INSTALLATION

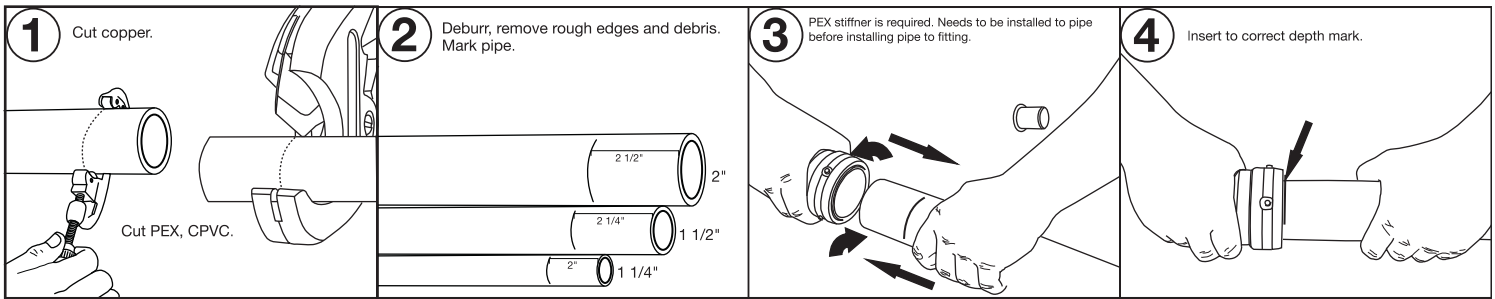

## TYPICAL REMOVAL

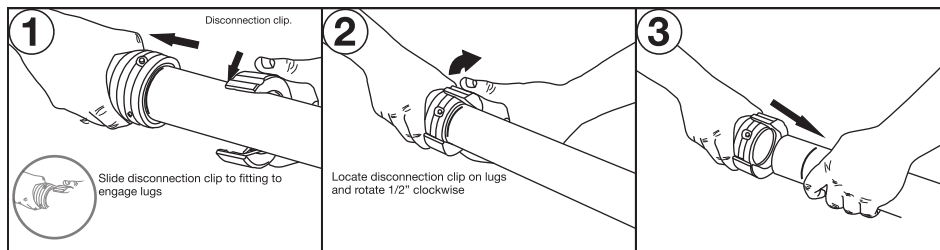



# SharkBite® 2XL

For Copper, CPVC, or PEX Pipe

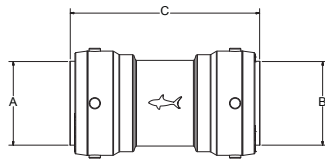

Coupling

P/N	A	B	C	Weight
SB0135	1¼"	1¼"	4.1"	0.84
SB0141	1½"	1½"	4.37"	1.15
SB0154	2"	2"	4.80"	1.56
SB013528	1¼"	1"	3.26"	0.69
SB014135	1½"	1¼"	4.37"	1.02
SB015441	2"	1½"	4.80"	1.42

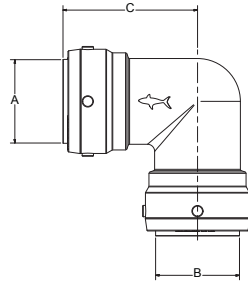

Elbow

P/N	A	B	C	Weight
SB0235	1¼"	1¼"	2.80"	1.07
SB0241	1½"	1½"	3.16"	1.52
SB0254	2"	2"	3.60"	2.18

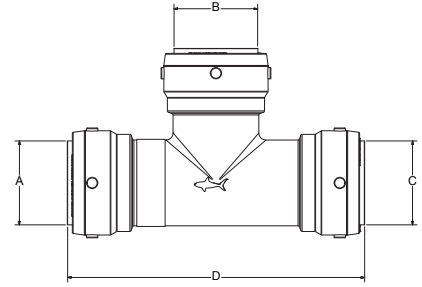

Tee

P/N	A	B	C	D	Weight
SB0335	1¼"	1¼"	1¼"	6.50"	1.61
SB0341	1½"	1½"	1½"	6.70"	2.26
SB0354	2"	2"	2"	7.99"	3.07
SB03353516	1¼"	½"	1¼"	6.70"	1.25
SB03353522	1¼"	¾"	1¼"	6.70"	1.28
SB03353528	1¼"	1"	1¼"	6.70"	1.42
SB03414122	1½"	¾"	1½"	7.39"	1.78
SB03414128	1½"	1"	1½"	7.39"	1.92
SB03414135	1½"	1¼"	1½"	7.39"	2.08
SB03545428	2"	1"	2"	7.99"	2.55
SB03545435	2"	1¼"	2"	7.99"	2.72
SB03545441	2"	1½"	2"	7.99"	2.86

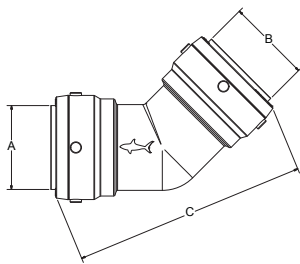

45° Elbow

P/N	A	B	C	Weight
SB0535	1¼"	1¼"	5.15"	0.97
SB0541	1½"	1½"	5.77"	1.35
SB0554	2"	2"	6.50"	1.91

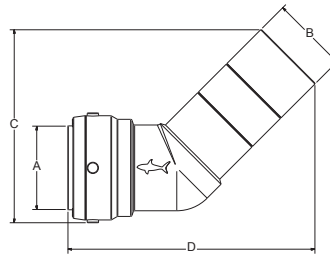

Street 45° Elbow

P/N	A	B	C	D	Weight
SB0735	1¼"	1¼"	4.24"	5.45"	0.97
SB0741	1½"	1½"	4.70"	6.05"	1.35
SB0754	2"	2"	5.30"	6.74"	1.91

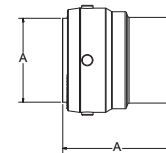

End Stop

P/N	Size	A	Weight
SB0435	1¼"	2.35"	0.57
SB0441	1½"	2.62"	0.82
SB0554	2"	2.89"	1.25

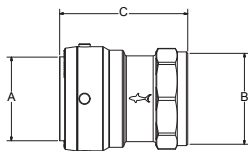

Female Connector

P/N	A	B	C	Weight
SB113532F	1¼"	1¼" FNPT	2.98"	0.72
SB114140F	1½"	1½" FNPT	3.21"	0.92
SB115450F	2"	2" FNPT	3.42"	1.23

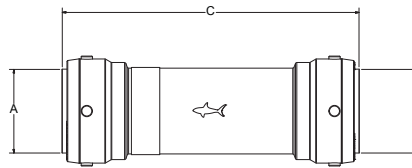

Slip Coupling

P/N	A	B	C	Weight
SB0635	1¼"	1¼"	6.69"	1.20
SB0641	1½"	1½"	7.40"	1.71
SB0654	2"	2"	7.98"	2.33



Demount Clip

P/N	Size	Weight
SBDC35	1¼"	0.07
SBDC41	1½"	0.08
SBDC54	2"	0.09

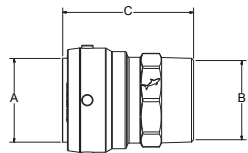

Male Connector

P/N	A	B	C	Weight
SB113532M	1¼"	1¼" MNPT	3.03"	0.71
SB114140M	1½"	1½" MNPT	3.20"	0.89
SB115450M	2"	2" MNPT	3.43"	1.20

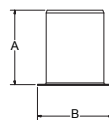

Pex Stiffener

P/N	Size	A	B	Weight
SBLT35	1¼"	1.65"	1.34"	0.08
SBLT41	1½"	1.89"	1.59"	0.10
SBLT54	2"	2.09"	2.09"	0.15

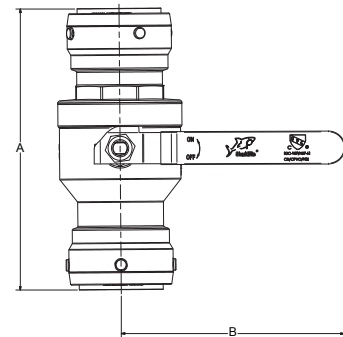

Ball Valve

P/N	Size	A	B	Weight
SBBV435	1¼"	6.08"	5.10"	2.06
SBBV441	1½"	6.79"	6.10"	2.99
SBBV454	2"	7.58"	6.16"	4.45

\* All weights are in pounds

