

# CAST IRON SQUARE FLOOR SINK - ARE

## 861 SERIES

### SPECIFICATION

Sioux Chief 861 Series 12" x 12" x 6" deep floor sink. Cast iron body with white acid-resisting enamel coated interior and top, includes aluminum dome strainer. Designed in accordance with ASME A112.6.7

Used in kitchens, restaurants, grocery stores, hospitals, schools and other areas that require a sanitary drain.

### MATERIALS

**Grate:** Nickel-bronze, enamel-coated cast iron

**Sink:** enamel-coated cast iron

### DIMENSIONS

**A:** Connection (No-Hub)      2"      3"      4"

ITEM # SUBMITTED	_____
JOB NAME	_____
LOCATION	_____
ENGINEER	_____
CONTRACTOR	_____
PO#	_____ TAG _____



861-Q2326

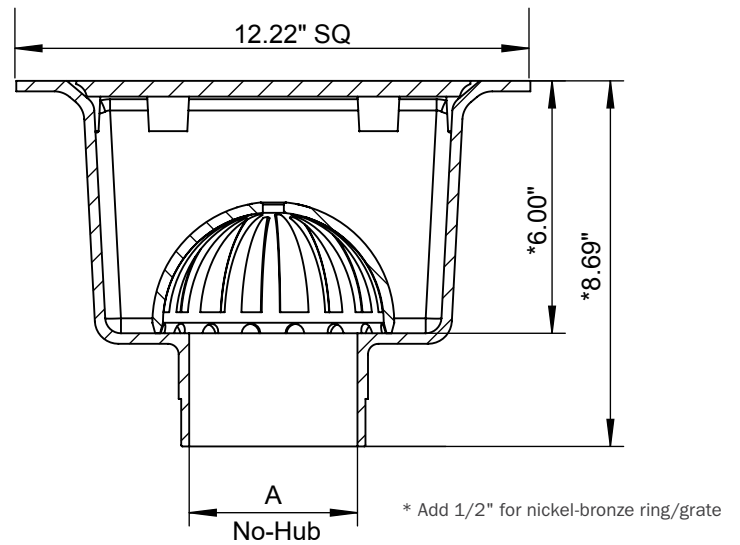

### Create Item Number

#### 861-A B C

e.g. **861-Q2326A2:** 3" No-Hub floor sink with open-half enamel-coated cast iron grate

#### CONNECTION SIZE **A**

**Q2226** = 2" No-Hub

**Q2326** = 3" No-Hub

**Q2426** = 4" No-Hub

#### GRATE TYPE **B**

No grate (standard)

**A** = enamel-coated cast iron grate

**N** = Nickel-bronze frame/grate

#### OPTIONS **C**

**2** = Open-half grate

**3** = Open-quarter grate

**B** = Aluminum Debris bucket

**T** = Trap primer adapter