

# Fast Track™

▶▶ Pre-sloped Trench Drain System

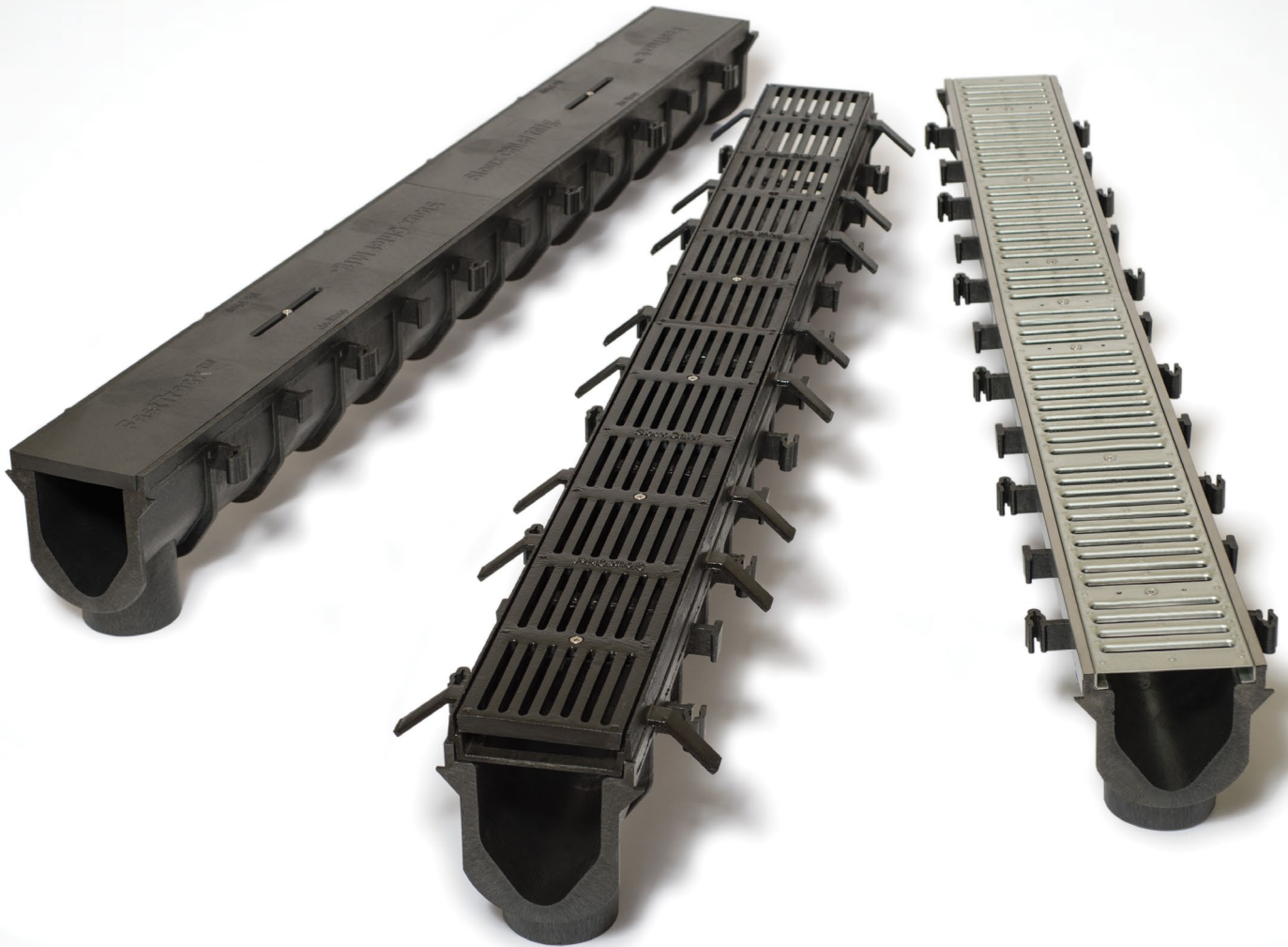

## Fast

Construction cover included to protect channels during rough-in. Longer channels for fewer joints and solid connections for better alignment.

## Versatile

Sloped and neutral channels made from lightweight, durable HDPE material. A variety of grating options for all types of traffic applications. Integral bottom outlet connection or attach end outlet.

Supply

Drainage

Support

[www.siouxchief.com](http://www.siouxchief.com)

TAKE THE FIELD.



# FastTrack™

## System Features

- Durable construction covers protect channels during rough-in. Keeps concrete and debris out of the drain line
- Channels molded from tough, lightweight, high-density polyethylene are U.V. and chemical resistant
- Longer (72") channels mean fewer joints are needed for the same run length
- Solid channel joints that don't require fasteners
- Grate anchors and structural ribs prevent deformation during the concrete pour
- Convenient, integral bottom outlet included on all channels. End caps and end outlets are also available
- Optional ductile iron frames and a variety of grating for all types of traffic applications

Construction covers are included with all channels

Specially designed bottom radius helps increase low-volume flow rate and reduce sediment buildup

Pre-molded 4" No-Hub bottom outlet

End Outlet

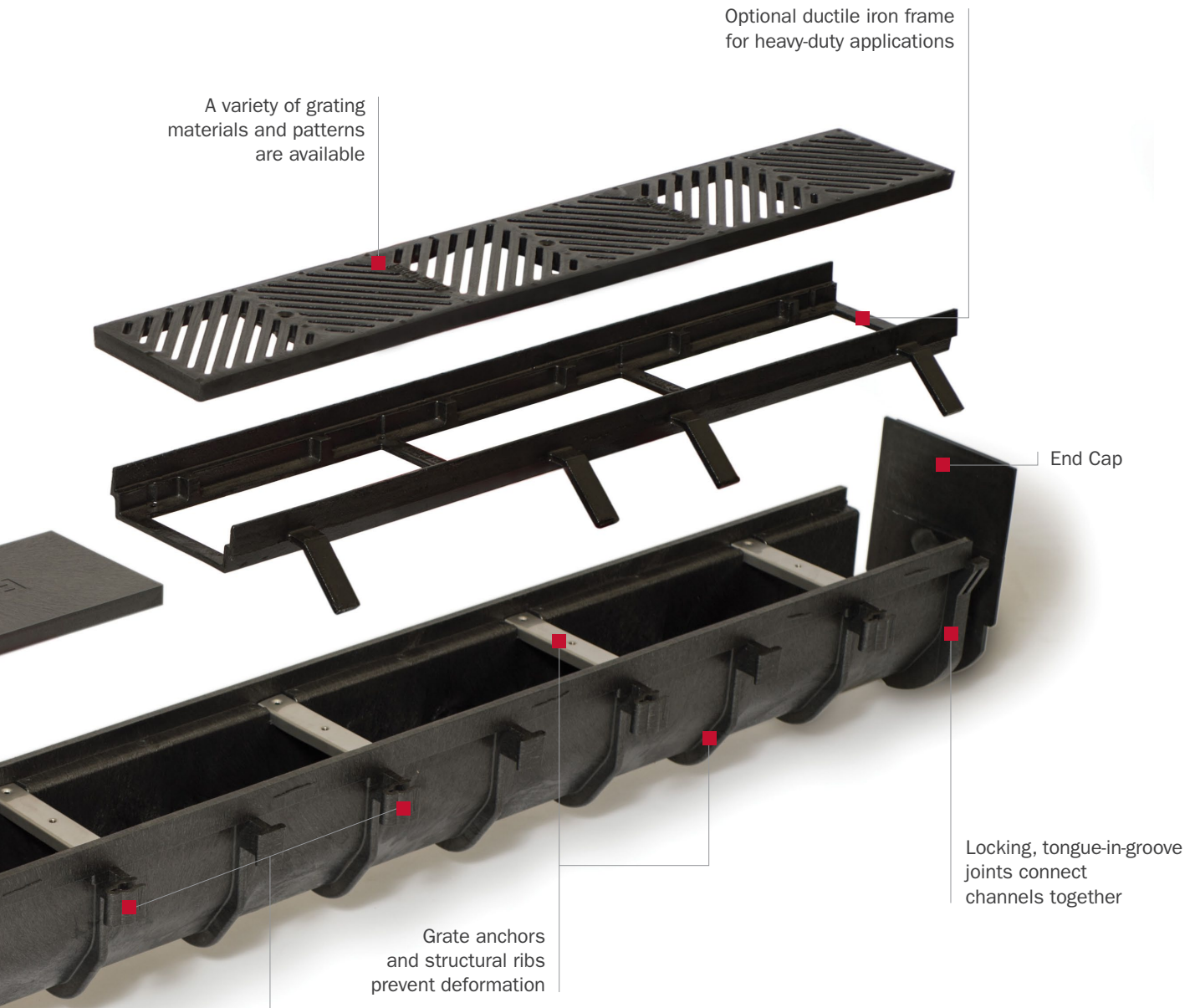

A variety of grating materials and patterns are available

Optional ductile iron frame for heavy-duty applications

End Cap

Locking, tongue-in-groove joints connect channels together

Grate anchors and structural ribs prevent deformation

Rebar anchors to secure channels during the concrete pour



Construction covers can slide across joints to help keep the run straight

# Installation Guide

»» Always wear protective gear and observe safety precautions when installing the FastTrack™ system.

## Plan/Excavate

Excavate a trench for the FastTrack™, considering both load class and slab thickness. All channels must be encased on three sides with a minimum of 4" of concrete. For slabs thicker than 4", encasement must be equal to slab thickness. The engineer should determine slab thickness based on application and traffic rating.

Concrete encasement is required regardless of surface type (concrete, asphalt, pavers, etc.).

Expansion joints will be needed on each side of the trench, according to specifications. Do Not use the FastTrack™ as an expansion joint.

Set a string line in the trench at level of final slab elevation to use as a guide.

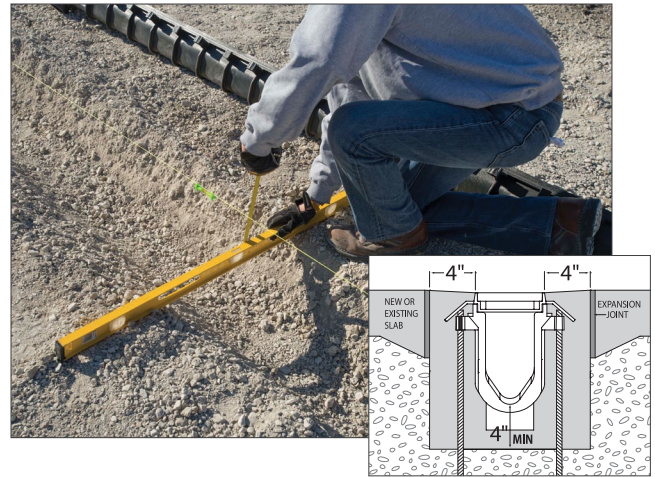

## Layout Channels

Lay out the channels, in order, alongside the excavated trench, starting with the deepest point and working back. Be sure flow arrows point towards the outlet end.

For End Outlet: Open the end outlet fitting using a hole saw. Attach the end outlet with screws to the deep end and the end cap on the shallow end. If using an end outlet, be sure to allow for sufficient slab thickness above the outlet and pipe.

For Bottom Outlet: Using a hole saw, open the bottom outlet in the deep end and install end caps on both the deep and shallow ends.



## Assemble Channels

Set channel sections in order into the trench. Beginning at the outlet end, connect the channels together using silicone sealant in the groove if desired.

If Using Iron Grate Frames: Remove the construction covers and install iron grate frames. Reinstall the construction covers in the frames.

Slide the construction covers (downstream) such that they overlap the joint - this will help prevent misalignment at the joints.



## Anchor with Rebar

Beginning at the outlet end, install rebar into the anchor clips on either side of the channel and drive rebar into the ground. Adjust channel vertically to the proper elevation, checking for level and alignment using the string line as a guide. The top of the channel should be set  $1/16"$  to  $1/8"$  below finish slab level.

When the channel is in proper position, secure the rebar into the anchor clips using screws or tie-wire to lock in place.

Continue the installation with upstream sections, setting with rebar, checking for elevation, level, and alignment until all channel sections are set.



## Set with Concrete

Confirm all channels are in final position and anchored with rebar and screws (wire) in ALL available anchor clips to keep the run as secure as possible. Be Sure:

- Channels will be encased in 4" of concrete (min.)
- Expansion joints will be installed on each side
- Channel is recessed  $1/16"$  to  $1/8"$  below the finish slab

Connect drain piping to the channel outlet according to plans using a No-Hub coupling.

Set concrete "pads" around rebar, under and on sides of the channels to prevent movement or misalignment during the final pour.

Pour the concrete slab around the installation and vibrate to eliminate voids in the pour.



## Final Inspection

After the concrete takes final set (24 hrs. min), remove the construction covers. Inspect the installation to be sure channels and drain piping are free of debris. Set appropriate grating in place and secure the grates into the grate anchors using screws.



# Grate Options

**Slotted Ductile Iron** Load Class D400\* (DIN EN 1433)  
 Enamel-coated ductile iron material. Heavy duty applications, pneumatic-tire forklift and commercial vehicle traffic at less than 15 mph.

*\*Load class D when installed in iron frame only*

**Width:** 6" **Length:** 36"  
**Weight:** 18.9 lbs. **Open Area:** 86.0 in<sup>2</sup>  
**Heel-proof:** No **ADA:** No

**Cross-Slot Ductile Iron** Load Class C250 (DIN EN 1433)  
 Enamel-coated ductile iron material. Decorative/ADA pattern. Parking areas and truck traffic at less than 15 mph.

**Width:** 6" **Length:** 36"  
**Weight:** 19.3 lbs. **Open Area:** 64.0 in<sup>2</sup>  
**Heel-proof:** No **ADA:** Yes

**Diagonal-Slot Ductile Iron** Load Class C250 (DIN EN 1433)  
 Enamel-coated ductile iron material. Decorative/ADA pattern. Parking areas and truck traffic at less than 15 mph.

**Width:** 6" **Length:** 36"  
**Weight:** 19.2 lbs. **Open Area:** 59.0 in<sup>2</sup>  
**Heel-proof:** Yes <sup>1</sup> **ADA:** Yes

**Slotted HDPE** Load Class A15 (DIN EN 1433)  
 Corrosion-proof, U.V. protected HDPE material is tough, durable and chemical-resistant. For light duty areas, pedestrian traffic, walkways, pool areas, etc.

**Width:** 6" **Length:** 36"  
**Weight:** 3.6 lbs. **Open Area:** 81.4 in<sup>2</sup>  
**Heel-proof:** No **ADA:** No

**Slotted Stainless/Galvanized** Load Class A15 (DIN EN 1433)  
**Reinforced Slotted Stainless/Galvanized** Load Class C250 (DIN EN 1433)  
 Corrosion-resistant, 304 stainless steel or G90 galvanized material. Standard models for pedestrian, bicycle, and two-wheeled hand carts. Reinforced models have a coated, ductile iron "framework" for heavy-duty loads.

**Width:** 6" **Length:** 36"  
**Weight:** Galv: 5.5 / SS: 4.3 lbs. **Open Area:** 60.0 in<sup>2</sup>  
**Weight (reinforced):** Galv: 16.0 / SS: 14.8 lbs.  
**Heel-proof:** No **ADA:** No

**Perforated Stainless/Galvanized** Load Class A15 (DIN EN 1433)  
 Corrosion-resistant, 304 stainless steel (16 gauge) or G90 galvanized (14 gauge) material. For pedestrian and hand-cart traffic, kitchen and food-prep areas.

**Width:** 6" **Length:** 36"  
**Weight:** Galv: 5.6 / SS: 4.4 lbs. **Open Area:** 34.0 in<sup>2</sup>  
**Heel-proof:** Yes <sup>1</sup> **ADA:** Yes

<sup>1</sup> Per ASME A112.6.3 requirements

## » Grate Load Classifications

Tested according to DIN EN 1433 standard. Trench drain grates are subjected to test loads, which are applied with a 3" x 10" platen.

**Class A**  
 Loads up to 3,372 LBS  
 Pedestrian traffic. Walking areas, bicycles, light, two-wheeled hand carts

**Class B**  
 Loads up to 28,101 LBS  
 Small/private parking areas. Car and light vehicle traffic at less than 15 mph.

**Class C**  
 Loads up to 56,202 LBS  
 Trucks and commercial parking areas. Vehicle traffic at less than 15 mph.

**Class D**  
 Loads up to 89,924 LBS  
 Pneumatic-tire forklift and commercial vehicle traffic at less than 15 mph.

# Accessories



## End Cap / End Outlet

HDPE end cap or 4" No-Hub outlet connection (open outlet with hole saw). Installs easily with screws, use sealant if desired. Trim excess off top; flush with construction cover prior to slab pour.

*When using end outlet, be sure to allow for sufficient slab thickness above the outlet and pipe.*



## Decorative Edge Guards

Corrosion-resistant, 304 stainless steel edge guards cover channel edges for a more finished look. Works with all grate styles/materials - does not affect load capacity of grate. Edge guards slide over top edge of the channel. Fasten with screws if desired.\*

*\* Edge guards must be installed before concrete is poured.*



## Ductile Iron Frame

Enamel-coated ductile iron material. Prevents wear/impact damage to channel edges. Transfers traffic load into the surrounding concrete. Works with all grate styles/materials. Must be used with iron grates for Class D load requirements. Iron frames attach easily to the channel with screws.\*

*\* Frames must be installed before concrete is poured.*



## Grate Anchor

*All channels ship with six grate anchors installed as standard.*

Stainless steel grate anchor spans the channel. 1/4-20" center tap for grate screws. Tap in place with hammer, fasten with screws if desired.



## Construction Cover

*All channels ship with two covers installed as standard.*

Durable, U.V. protected cover installs in the channel during rough-in and slab pour. Construction cover protects channels from damage and debris. Covers slide to overlap joints and help maintain alignment. Use with or without iron frame. Replace with grate after slab cures.



## Dome Bottom Strainer

Stainless steel perforated strainer installs above bottom outlet to prevent trash, leaves, and other debris from entering the drain pipe. Spring-tabs insert into the outlet and hold strainer in place. Removes easily for cleaning.

# Typical Configurations

## »» Sloping

- FastTrack™ channels are available pre-sloped (0.75%) or neutral. Systems can be designed using all sloped, all neutral, or both types
- Neutral channels can be used where the ground itself slopes or where excavation depth must be minimized

### All Sloped - One Direction 54 ft



### Sloped & Neutral - One Direction 78 ft



### Neutral / No Slope

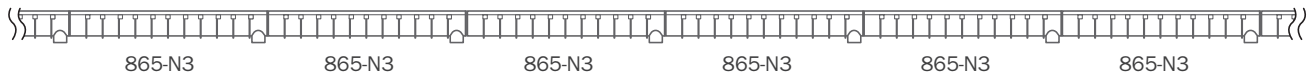

## »» Outlet Type

- FastTrack™ channels are designed with an integral bottom outlet or attach an end outlet for pipe connection
- Bottom and end outlet size is 4" no-hub - make connection to the pipe with standard no-hub couplings

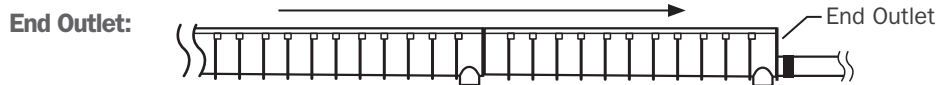

When using end outlets, be sure to allow sufficient slab depth above outlet and drain pipe to prevent cracking.

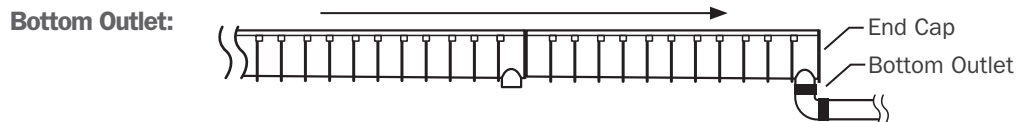



## »» Outlet Location

- Connect drain pipe to the FastTrack™ on the bottom of the channel or to the end
- Systems can be designed to slope to one end, to the center, to both ends or to multiple bottom outlets

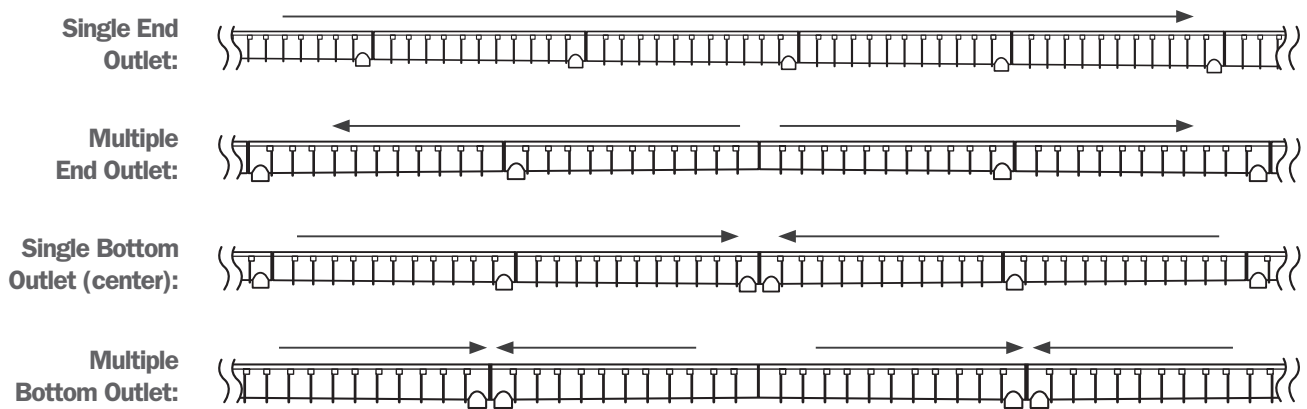

## »» Cutting

- FastTrack™ channels and grates can be cut to length with a handsaw or reciprocating saw
- Ribs on the channels are spaced at 6" intervals for quick measurements and allow for easy attachment of the end cap. Always cut end(s) opposite the outlet

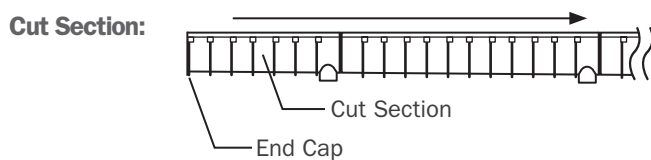

## »» System Notes

- The FastTrack™ system is designed for on-grade installations only
- Using neutral channels will affect the overall slope of the system and the estimated flow rate
- Channels must be encased in concrete (three sides) of specified thickness; regardless of surface, material/finish
- Always install expansion joints on both sides of, and parallel to the channel, per specifications
- Finished grate level should be 1/16" — 1/8" below finished slab level and slab should be sloped toward the channel on both sides to promote proper drainage

# Chemical Resistance Guide



The following should be used for reference only. Many factors affect the chemical resistance of a product. A test under specific conditions should confirm the FastTrack™ is fully compatible with the application before installation.

**Letter indicates resistance to given chemical - Number indicates temperature of chemical.**

A = Little/No effect after 30 days constant exposure B = Some damage after 7 days constant exposure C = Not Recommended

1,4-dioxane	A	70	Ethyl benzene	C	N/A	n-butyl alcohol	A	120
Acetaldehyde	A	70	Ethyl ether	C	N/A	Nitric acid 20%	A	70
Acetic Acid 5 %	A	120	Ethylene dichloride	C	N/A	Nitromethane	C	N/A
Acetic Acid, glacial 50%	A	70	Ethylene glycol	A	120	n-octane	A	120
Acetone	C	N/A	Ethylene oxide	B	70	Oxalic acid 10%	A	120
Allyl Alcohol	A	120	Fatty Acids	A	120	Perchloric acid	A	70
Aluminum salts	A	120	Ferric chloride	A	120	Perchloric ethylene	C	N/A
Amino acids	A	120	Fluoride	A	120	Phenol	C	N/A
Ammonia	A	120	Fluorine	B	70	Phosphoric acid 10%	A	120
Ammonium carbonate, sat.	A	120	Formaldehyde 10%	A	120	Phosphoric acid 85%	A	70
Ammonium hydroxide 30%	A	120	Formaldehyde 40%	A	120	Phosphorous trichloride	A	70
Ammonium phosphate	A	120	Fructose	A	120	Potassium carbonate	A	120
Ammonium sulfate	A	120	Fuel Oil	A	120	Potassium hydroxide	A	120
Amyl chloride	C	N/A	Gasoline	A	70	Potassium permanganate	A	120
Aniline	A	70	Glycerol	A	120	Propylene glycol	A	120
Battery Acid	A	120	Heptane	C	N/A	Pyridine	C	N/A
Beer	A	120	Hexane	C	N/A	Salicylic acid, sat.	A	120
Benzene	C	N/A	Hydraulic Fluid	A	70	Silver acetate	A	120
Benzyl alcohol	B	70	Hydrochloric acid 5%	A	120	Silver nitrate	A	120
Boric acid	A	120	Hydrochloric acid 35%	A	120	Sodium carbonate	A	120
Brake Fluid	A	120	Hydrocyanic acid	A	120	Sodium chloride, sat.	A	120
Bromine	B	70	Hydrofluoric acid	A	120	Sodium dichromate	A	120
Butyric acid	B	70	Hydrofluoric acid 4%	A	120	Sodium hydroxide 10%	A	120
Calcium chloride	A	120	Hydrofluoric acid 48%	A	120	Sodium hypochlorite 15%	A	70
Calcium hydroxide sat.	A	120	Hydrogen peroxide 3%	A	120	Sodium nitrate	A	120
Carbon tetrachloride	C	N/A	Hydrogen peroxide 30%	A	120	Sodium sulphate	A	120
Chlorine 10% in water	A	100	Isobutyl alcohol	A	120	Sucrose	A	120
Chlorobenzene	C	N/A	Isopropyl acetate	B	70	Sulfur dioxide	C	N/A
Chloroform	B	70	Isopropyl alcohol	A	120	Sulfuric acid 20%	A	120
Chromic acid 10%	A	120	Kerosene	B	70	Sulfuric acid 60%	A	120
Citric acid 10%	A	120	Lactic Acid 90%	A	120	Tannic acid	A	120
Citrus Juice	A	120	Lead acetate	A	120	Toluene	C	N/A
Cresol	C	N/A	Metallic salts, dissolved	A	120	Trichloroacetic acid	C	N/A
Cyclohexane	C	N/A	Methanol	A	120	Trichlorethane	C	N/A
Dibutyl Ether	C	N/A	Methyl ethyl ketone	C	N/A	Trisodium phosphate	A	120
Dichloroethane	C	N/A	Methyl propyl ketone	C	N/A	Turpentine	C	N/A
Diethyl ketone	C	N/A	Methylene chloride	C	N/A	Urea/Urine	A	120
Dimethylsulfoxide	A	120	Milk	A	120	Vinegar	A	120
Ethanol 95%	A	120	Mineral oil	A	70	Water (Distilled/Soft/Hard)	A	140
Ethyl acetate	A	120	Motor/Engine oil	A	70	Xylene	B	70
Ethyl Alcohol 95%	A	120	n-amyl acetate	A	70	Zinc chloride	A	120

# Channel Specs

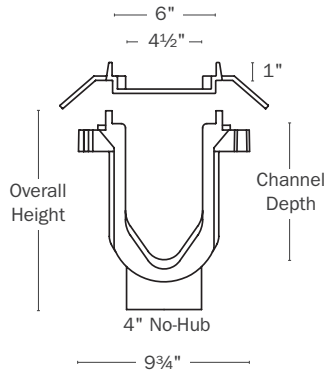

- U.V. protected, black, high-density polyethylene material
- Channels available pre-sloped (0.75%) or neutral
- All channels include pre-installed grate anchors (6) and construction covers (2)

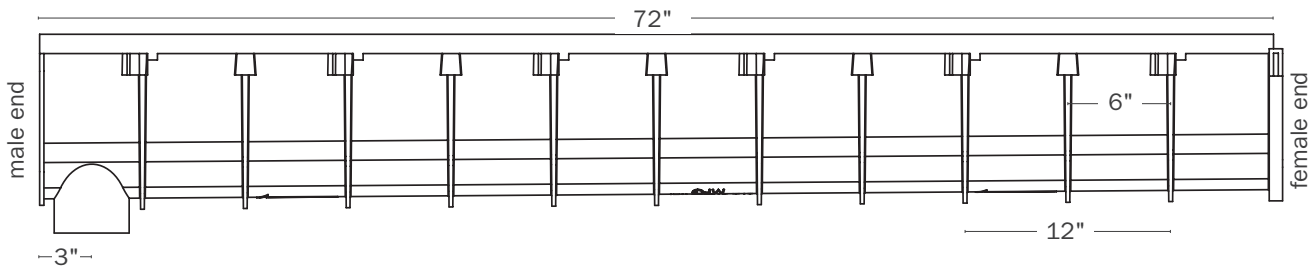

Channel	Channel Depth		Overall Height <sup>1</sup>	Slope Type	Weight <sup>2</sup> Lbs.	Est. Flow Rate <sup>3</sup>	
	Shallow End	Deep End				GPM	CFS
865-S1	3.63"	4.13"	7.25"	Sloped	15.4	91.23	0.20
865-S2	4.13"	4.63"	7.75"	Sloped	16.4	119.13	0.27
865-N3	4.63"	4.63"	7.75"	Neutral	16.9	—	—
865-S3	4.63"	5.13"	8.25"	Sloped	17.4	147.79	0.33
865-S4	5.13"	5.63"	8.75"	Sloped	18.4	176.97	0.39
865-N5	5.63"	5.63"	8.75"	Neutral	18.9	—	—
865-S5	5.63"	6.13"	9.25"	Sloped	19.4	206.55	0.46
865-S6	6.13"	6.63"	9.75"	Sloped	20.4	236.42	0.53
865-N7	6.63"	6.63"	9.75"	Neutral	20.9	—	—
865-S7	6.63"	7.13"	10.25"	Sloped	21.4	266.52	0.59
865-S8	7.13"	7.63"	10.75"	Sloped	21.4	296.81	0.66
865-N9	7.63"	7.63"	10.75"	Neutral	21.9	—	—
865-S9	7.63"	8.13"	11.25"	Sloped	22.4	327.23	0.73

**1** Add 1" to overall height when using iron frame

**2** Weight includes grate anchors and construction covers

**3** Estimated flow rate is for the single channel only (open ends, no grate), and is based on calculation using Manning's equation



865-S1



865-GIS



865-E0



865-F

**»» Buying Information**

ITEM NO.	DESCRIPTION	PKG.	MIN. QTY.	CASE QTY.
<b>CHANNELS</b>				
865-S1	Sloped Channel Section W/ Construction Cover - 72" Long	B	1	1
865-S2	Sloped Channel Section W/ Construction Cover - 72" Long	B	1	1
865-N3	Neutral Channel Section W/ Construction Cover - 72" Long	B	1	1
865-S3	Sloped Channel Section W/ Construction Cover - 72" Long	B	1	1
865-S4	Sloped Channel Section W/ Construction Cover - 72" Long	B	1	1
865-N5	Neutral Channel Section W/ Construction Cover - 72" Long	B	1	1
865-S5	Sloped Channel Section W/ Construction Cover - 72" Long	B	1	1
865-S6	Sloped Channel Section W/ Construction Cover - 72" Long	B	1	1
865-N7	Neutral Channel Section W/ Construction Cover - 72" Long	B	1	1
865-S7	Sloped Channel Section W/ Construction Cover - 72" Long	B	1	1
865-S8	Sloped Channel Section W/ Construction Cover - 72" Long	B	1	1
865-N9	Neutral Channel Section W/ Construction Cover - 72" Long	B	1	1
865-S9	Sloped Channel Section W/ Construction Cover - 72" Long	B	1	1
<b>GRATES</b>				
865-GiS	Slotted Ductile Iron Grate W/ Screws - 36" Long	B	1	1
865-GiC	Cross-Slot Ductile Iron Grate W/ Screws - 36" Long	B	1	1
865-GiD	Diagonal-Slot Ductile Iron Grate W/ Screws - 36" Long	B	1	1
865-GHS	Slotted HDPE Grate W/ Screws - 36" Long	B	1	1
865-GSS	Slotted Stainless Steel Grate W/ Screws - 36" Long	B	1	1
865-GSSR	Reinforced Slotted Stainless Steel Grate W/ Screws - 36" Long	B	1	1
865-GSD	Perforated Stainless Steel Grate W/ Screws - 36" Long	B	1	1
865-GGS	Slotted Galvanized Steel Grate W/ Screws - 36" Long	B	1	1
865-GGSR	Reinforced Perforated Galvanized Steel Grate W/ Screws - 36" Long	B	1	1
865-GGD	Perforated Galvanized Steel Grate W/ Screws - 36" Long	B	1	1
<b>ACCESSORIES</b>				
865-E0	End Outlet - HDPE W/ 4" No-Hub Connection – to open outlet, use hole saw.*	B	1	1
865-EC	End Cap - HDPE Flat Cap – Fits All Channels	B	1	1
865-EG	SS Edge Guards - 36" Long – Pair W/ Screws	B	1	1
865-F	Ductile Iron Grate Frame - 36" Long W/ Screws	B	1	1
865-A	Grate Anchor - Stainless – Fits All Channels	B	1	1
865-C	Construction Cover - HDPE 36" Long – Fits All Channels	B	1	1
865-D	Dome Bottom Strainer - Stainless steel – For Bottom Outlet	B	1	1

\* If using end outlet, be sure to allow for sufficient slab thickness above the outlet and pipe.

**PACKAGING:**

B = Bulk

C = Cut Case

I = Individually Bar-Coded

24110 South Peculiar Drive  
Peculiar, Missouri 64078**P** 1.800.821.3944**F** 1.800.758.5950

#LT2-FASTTRACK

www.siouxchief.com

B.9/16 FASTTRACK

