



Flexible Couplings for DWV & Non-Pressure Transitions

Transitions all types of DWV plastic, and cast iron.

- 300 series stainless steel clamps
- Flexibility - Sleeve is manufactured of molded natural and synthetic rubber or vinyl

Complies with:

- ASTM C1173-2002 • IAPMO 4933



• Use PASCO 2SH

New! For Condensate

PART NUMBER	DESCRIPTION
56075	3/4" PVC - 1" Copper
56100	1" PVC - 1-1/4" Copper

PART NUMBER	SIZE
56125	1-1/4"
5615125	1-1/2" x 1-1/4"
5615	1-1/2"
56215	2" x 1-1/2"
5622	2"
56315	3" x 1-1/2"
5632	3" x 2"
5633	3"
56415	4" x 1-1/2"
5642	4" x 2"
5643	4" x 3"
5644	4"
5653	5" x 3"
5654	5" x 4"

PART NUMBER	SIZE
5655	5"
5663	6" x 3"
5664	6" x 4"
5665	6" x 5"
5666	6"
5684	8" x 4"
5686	8" x 6"
5688	8"
561010*	10"
561212*	12"
561515L*	15" x 11"
561515S*	15" x 6-1/2"
561818L*	18" x 11"
561818S*	18" x 6-1/2"

*Part numbers with an asterisk are made in U.S.A.

Plastic DWV Socket to Pipe Socket to Socket Couplings

New!



Socket to Pipe

PART NUMBER	SIZE
59150	1-1/2"
5922	2"
5933	3"
5944	4"



Socket to Socket

PART NUMBER	SIZE
60150	1-1/2"
6022	2"
6033	3"
6044	4"

High Quality Neoprene Flex Couplings

New!



IAPMO Listed

PART NUMBER	SIZE
US5622	2"
US5633	3"
US5644	4"
US5666	6"



Cast Iron Bell Joint Gaskets “Donuts”

- Use to join cast iron bell DWV to cast iron or plastic DWV.
- Replaces lead and oakum style joints



Sealing ribs exposed for illustration



PART NUMBER	SIZE
56139	2" x 1-1/2"
56205	2"
563205	3" x 2"
56305	3"
56405	4"
564205	4" x 2"
564305	4" x 3"

Flexible Fittings for DWV

Replacements for Fittings Cut Out of Joints

Ells



PART NUMBER	SIZE
5815	1-1/2"
5822	2"
5833	3"
5844	4"

Tees



PART NUMBER	SIZE
5715	1-1/2"
5722	2"
5733	3"
5744	4"

Multi Seal Gasket

- Multi-seal OD and ID rings
- Natural rubber complies with ASTM C-564

Made in U.S.A.



PART NUMBER	SIZE
95002	2" SV
95003	3" SV
95004	4" SV

Flexible PVC Trap Adapters

- Trap connectors are ideal for new installation, repairs and alterations.
- The 5915 size connects 1-1/4" or 1-1/2" tubular traps to all common 1-1/4" or 1-1/2" drain piping.
- The 5925 size connects 1-1/4" or 1-1/2" tubular traps to all common 2" drain piping, except copper. (For 2" copper, use 5915)
- Stainless steel clamps



PART NUMBER	DRAIN SIZE
5915	1-1/4" or 1-1/2"
5925	1-1/4" or 1-1/2" to 2"

PVC Hose Grip Clothes Washer Connector

- Holds washing machine hoses securely in their standpipe drains.
- The Hose Grip has 4 vents to allow for air flow during discharge from washer.
- Stainless steel clamp



PART NUMBER
5930

Flexible PVC Tubular Trap

- There's no faster, easier way to replace 1-1/4" or 1-1/2" plastic or metal drain traps. It's flexible PVC material adjusts to pipe misalignment and in installs quickly and securely with a common screwdriver or nutdriver.
- Stainless steel clamps



PART NUMBER	DRAIN SIZE
5900	1-1/4" or 1-1/2" to 1-1/2"

Flexible PVC Tubular Drain Pipe Connector

- For any combination of 1-1/2" or 1-1/4" tubular drain pipe.
- Stainless steel clamps



PART NUMBER	DRAIN SIZE
5905	1-1/4" and 1-1/2"



Heavy Duty No-Hub Couplings

PASCO No-Hub couplings utilize the unique “High Efficiency” (HE) clamp specifically developed for no-hub installations. This HE clamp offers the most band load in the industry when 80 lbs. of installation torque is applied.

- 304 Stainless Steel
- Comply with ASTM C-1540
- Conform to CISPI 310
- Additional clamps provide better sealing and load distribution
- 5/16” Hex head screws



• Use **PASCO 2SM**

PART NUMBER	SIZE
PNHC-1.5HD	1-1/2”
PNHC-2HD	2”
PNHC-3HD	3”
PNHC-4HD	4”
PNHC-5HD	5”
PNHC-6HD	6”
PNHC-8HD	8”
PNHC-10HD	10”
PNHC-12HD	12”

No-Hub Couplings

PASCO No-Hub couplings utilize the unique “High Efficiency” (HE) clamp specifically developed for no-hub installations. This HE clamp offers the most band load in the industry when 60 lbs. of installation torque is applied.

- AISI 301 stainless steel band and shield.
- AISI 305 stainless steel screw
- Gaskets conform to ASTM C-564
- Complies with standards:
 - CSA B70-M91
 - CSA B602-M90
 - CISPI 310-95
 - ASTM C-1277



• Use **PASCO 2SH**

PART NUMBER	SIZE
PNHC-1.5	1-1/2”
PNHC-2	2”
PNHC-21.5	2” x 1-1/2”
PNHC-3	3”
PNHC-32	3” x 2”
PNHC-4	4”
PNHC-42	4” x 2”
PNHC-43	4” x 3”
PNHC-5	5”
PNHC-6	6”
PNHC-8	8”
PNHC-10	10”
PNHC-12	12”



ProSeal Flex Couplings

New!

Stainless Steel Shielded Transition Couplings designed for resistance to shear forces as well as corrosion.

PASCO's ProSeal Flex Couplings allow the plumber to make a wide variety of transition pipe connections. ProSeal Flex Couplings connect cast iron, plastic, copper, steel and tubular DWV systems.



- Meet ASTM C1460 and CSA B602.
- All 300 Series Stainless Steel Band and Clamp.
- Neoprene ASTM C564 gasket material.
- Clamp joined to shield with rivets, not welds.

58-CP Series

Cast Iron to Plastic, Steel or Extra-Heavy Cast Iron

PART NUMBER	CAST IRON, PLASTIC, STEEL	CAST IRON, PLASTIC, STEEL, XHCI	FERNCO PART NO.
58150CP	1-1/2"	1-1/2"	3000-150
58215CP	2"	1-1/2"	3000-215
58200CP	2"	2"	3000-22
5833CP	3"	3"	3000-33
5843CP	4"	3"	3000-43
5844CP	4"	4"	3000-44
5855CP	5"	5"	3000-55
5866CP	6"	6"	3000-66
5888CP	8"	8"	3000-88

58-CK Series

Cast Iron, Plastic or Steel to Copper

PART NUMBER	CAST IRON, PLASTIC, STEEL	COPPER	FERNCO PART NO.
58110CK	1-1/2"	1"	3001-110
581125CK	1-1/2"	1-1/4"	3001-1125
58115CK	1-1/2"	1-1/2"	3001-150
582125CK	2"	1-1/4"	3001-2125
58215CK	2"	1-1/2"	3001-215
5822CK	2"	2"	3001-22
58315CK	3"	1-1/2"	3001-315
5832CK	3"	2"	3001-32
5833CK	3"	3"	3001-33
5843CK	4"	3"	3001-43
5844CK	4"	4"	3001-44



• Use PASCO 2SH



**Couplings: Flex, ProSeal & No-Hub • Drains
Test Caps & Plugs • Cleanout Plugs • Cover Plates**

New!



58-T Series

Cast Iron, Plastic, Steel to Tubular

PART NO.	CI, PL, ST	TUBULAR	FERNCO PART NO.
58150T	1-1/2"	1-1/2"	3002-150
58150BWT		1-1/2" to 1-1/2"	3002-155
58215T	2"	1-1/2"	3002-215

58-K Series

Copper to Copper

PART NO.	COPPER TO COPPER	FERNCO PART NO.	
58150K	1-1/2"	1-1/2"*	3003-150
58215K	2"	1-1/2"	3003-215
58200K	2"	2"	3003-22
58300K	3"	3"	3003-33

* 1-1/4" Plastic also

58-C Series

Cast Iron to Cast Iron, Plastic or Steel

PART NO.	CI	CI, PL, ST	FERNCO PART NO.
58320C	3"	2"	3004-320
58420C	4"	2"	3004-420
58430C	4"	3"	3004-430
58540C	5"	4"	3004-540

58-P Series

Plastic, Steel, Extra Heavy Cast Iron to Plastic, Steel, Extra Heavy Cast Iron

PART NO.	PL, ST, XHCI	PL, ST, XHCI	FERNCO PART NO.
58300P	3"	3"	3005-33
58430P	4"	3"	3005-43
58400P	4"	4"	3005-44
58600P	6"	6"	3005-66

58-KC Series

Copper to Cast Iron, Plastic, Steel

PART NO.	COPPER	CI, PL, ST	FERNCO PART NO.
58215KC	2"	1-1/2"	3006-215
5832KC	3"	2"	3006-32
5843KC	4"	3"	3006-43

58-PK Series

Plastic, Steel or Extra Heavy Cast Iron to Copper

PART NO.	PL, ST, XHCI	COPPER	FERNCO PART NO.
5832PK	3"	2"	3007-32
5833PK	3"	3"	3007-33
5843PK	4"	3"	3007-43
5844PK	4"	4"	3007-44

58-PC Series

Plastic, Steel or Extra Heavy Cast Iron to Cast Iron, Plastic, Steel

PART NO.	PL, ST, XHCI	CI, PL, ST	FERNCO PART NO.
5832PC	3"	2"	3008-32

58-TWP Series

Thinwall Plastic to SCH 40 Plastic

PART NO.	TWP	SCH 40	FERNCO PART NO.
5833TWP	3"	3"	3009-33
5844TWP	4"	4"	3009-44

58-KT Series

Copper to Tubular

PART NO.	COPPER	TUBULAR	FERNCO PART NO.
58150KT	1-1/2"	1-1/2"	3010-150
58215KT	2"	1-1/2"	3010-215



Flex Couplings for DWV & Non-Pressure Transitions

Flexible coupling is manufactured from natural rubber, synthetic rubber or vinyl.

- 300 Series Stainless Steel Clamps
- Torque to 60 lbs.
- Repair existing pipe
- Flex Couplings comply with:
 - ASTM C1173-2002
 - IAPMO 4933



Made in USA or Taiwan

Clay to Clay

PART NUMBER	SIZE
56144	4"
56164*	6" x 4"
56165*	6" x 5"
56166	6"
56188	8"
5611010	10"

* Transition Style
 Equals Fernco 1001 Series
 Mission MR01 Series

Transition Style Concrete to Cast Iron/Plastic

New!

PART NUMBER	SIZE
56644	4"
56664	6" x 4"
56665	6" x 5"
56666	6"
56688	8"

Equals Fernco 1006 Series
 Mission MR06 Series

New!

Clay to AC/Ductile Iron

PART NUMBER	SIZE
56344	4"
56366	6"
56388	8"

Equals Fernco 1003 Series
 Mission MR03 Series

New!

AC/Ductile Iron to Cast Iron/Plastic

PART NUMBER	SIZE
565144	4"
565166	6"

Equals Fernco 1051 Series
 Mission MR51 Series

New!

Concrete to Concrete

PART NUMBER	SIZE
56444	4"
56464	6" x 4"*
56466	6"
56488	8"

* Transition Style
 Equals Fernco 1004 Series
 Mission MR04 Series

New!

AC/Ductile Iron to AC/Ductile Iron

PART NUMBER	SIZE
565544	4"
565566	6"

Equals Fernco 1055 Series
 Mission MR55 Series

Transition Style Clay to Cast Iron or Plastic

PART NUMBER	SIZE
56244	4"
56243	4" x 3"
56246	4" x 6"*
56264	6" x 4"
56265	6" x 5"
56266	6"
56288	8"
5621010	10"

* 4" Clay to 6" CI/PL
 Equals Fernco 1002 Series
 Mission MR02 Series



• Use PASCO 2SH



Stainless Steel Shear Rings

New!

Add extra strength to just about any size
PASCO 56 Series Flex Coupling*

PASCO's Stainless Steel Shear Rings are easy to attach and help maintain proper alignment of the **PASCO 56 Series Flex Coupling** in buried installations. For use with cast iron and plastic pipe.

*Part numbers 5615 to 561818



- Minimum Thickness .018"
- Clamps attached to Shear Ring
- 300 Series Stainless Steel Clamps and Sleeves.
- Made in USA.
- Designed to fit Pasco 56 Series Couplings.*
- Stock for use with regular flex coupling inventory.



PART NUMBER	FITS PASCO FLEX COUPLING	LENGTH	WIDTH	CLAMP SIZE
SR9	5615 - 1-1/2"	9"	1-1/2"	32
SR11	5622 - 2"	11"	1-1/2"	40
SR15	5633 - 3"	15"	2"	64
SR19	5644 - 4"	19"	2"	80
SR22	5655 - 5"	22"	2"	96
SR25	5666 - 6"	25"	4"	116
SR33	5688 - 8"	33"	4"	152
SR39	561010 - 10"	39"	4"	188
SR46	561212 - 12"	46"	4"	212
SR54L	561515L - 15"	54"	11"	260
SR63L	561818L - 18"	63"	11"	312
SR54S	561515S - 15"	54"	6-1/2"	260
SR63S	561818S - 18"	63"	6-1/2"	312

Also fits Fernco 1056, Mission Rubber MR56, Dallas Specialty DS56, NDS DFW56, Indiana Seal 156, Pipeconex PCX56 Flex Couplings.



Flex Couplings for DWV & Non-Pressure Transitions

Flexible coupling is manufactured from natural rubber, synthetic rubber or vinyl.

PASCO's 56 Series Flex Couplings with Stainless Steel Shear Rings resist heavy earth loads, shear forces and coupling deterioration caused by environmental effects.

- 300 Series Stainless Steel Clamps and Shear Rings
- Minimum thickness of Shear Ring is .018".
- Torque to 80 lbs.
- Repair existing pipe
- Flex Couplings comply with:
 - ASTM C1173-2002
 - IAPMO 4933



Stainless Steel Wormgear Clamps and Shear Ring

**Shear Rings
Made in the USA**

All Couplings made in the USA with the exception of the Cast Iron to Plastic 8" and under.

New! Concrete to Concrete

PART NUMBER	SIZE
56444SR	4"
56466SR	6"
56488SR	8"

Equals Fernco 1004 RC Series

Clay to Clay

PART NUMBER	SIZE
56144SR	4"
56164SR	6" x 4"*
56188SR	8"
5611010SR	10"

* Straight Through
 Equals Fernco 1001 RC Series

New! Concrete to Cast Iron/Plastic

PART NUMBER	SIZE
56644SR	4"
56664SR	6" x 4"*
56665SR	6" x 5"*
56666SR	6"
56688SR	8"

* Straight Through
 Equals Fernco 1006 RC Series

Cast Iron to Plastic Pipe

PART NUMBER	SIZE
5615SR	1-1/2"
5622SR	2"
5633SR	3"
5643SR	4" x 3"*
5644SR	4"
5655SR	5"
5664SR	6" x 4"
5666SR	6"
5688SR	8"
561010SR	10"
561212SR	12"
561515SRL	15" x 11"
561818SRL	18" x 11"
561515SRS	15" x 6-1/2"
561818SRS	18" x 6-1/2"

* Straight Through
 Equals Fernco 1056 RC Series

New! Clay to Cast Iron/Plastic

PART NUMBER	SIZE
56244SR	4"
56264SR	6" x 4"*
56265SR	6" x 5"*
56266SR	6"
56288SR	8"

* Straight Through
 Equals Fernco 1002 RC Series

New! AC/Ductile Iron to Cast Iron/Plastic

PART NUMBER	SIZE
565144SR	4"
565166SR	6"

Equals Fernco 1051 RC Series

New! Clay to AC/Ductile Iron

PART NUMBER	SIZE
56344SR	4"
56366SR	6"
56388SR	8"

Equals Fernco 1003 RC Series

New! AC/Ductile Iron to AC/Ductile Iron

PART NUMBER	SIZE
565544SR	4"
565566SR	6"

Equals Fernco 1055 RC Series



• Use PASCO 2SM



Flex Couplings for DWV & Non-Pressure Transitions

Flexible coupling is manufactured from natural rubber, synthetic rubber or vinyl.

PASCO's 56 Series Flex Couplings with Stainless Steel Shear Rings resist heavy earth loads, shear forces and coupling deterioration caused by environmental effects.

- 300 Series Stainless Steel Clamps and Shear Rings
- Minimum thickness of Shear Ring is .018"
- Torque to 80 lbs.
- Repair existing pipe
- Flex Couplings comply with:
 - ASTM C1173-2002
 - IAPMO 4933



Cast Iron, Plastic or Steel
to Cast Iron, Plastic or Steel

PART NUMBER	SIZE
5643PRC	4" x 3"*
5644PRC	4"
5655PRC	5"
5664PRC	6" x 4"*
5666PRC	6"
5688PRC	8"
561010PRC	10"
561212PRC	12"
561515PRCL	15" x 11"†
561818PRCL	18" x 11"†
561515PRCS	15" x 6-1/2"†
561818PRCS	18" x 6-1/2"†

Sizes 4" and 5" - Single Nut
 Sizes 6" and above - Double Nut
 • Straight Through † Length
 Equals Fernco 5056 RC Series
 Mission MR56 ARC

Tough Nut and Bolt Stainless Steel Clamps and Shear Ring

**Shear Rings
Made in the USA**
 All Couplings made in the
 USA with the exception of
 the Cast Iron to Plastic
 8" and under.

Clay to Clay

PART NUMBER	SIZE
56144PRC	4"
56164PRC	6" x 4"*
56166PRC	6"
56188PRC	8"
5611010PRC	10"

* Straight Through
 Equals Fernco 5001 RC Series
 Mission MR01 ARC

New! Clay to Cast Iron/Plastic

PART NUMBER	SIZE
56244PRC	4"
56264PRC	6" x 4"*
56266PRC	6"
56288PRC	8"

Equals Fernco 5002 RC Series
 Mission MR02 ARC

New! Clay to AC/Ductile Iron

PART NUMBER	SIZE
56344PRC	4"
56366PRC	6"
56388PRC	8"

Equals Fernco 5003 RC Series
 Mission MR03 ARC

New! Concrete to Concrete

PART NUMBER	SIZE
56444PRC	4"
56466PRC	6"
56488PRC	8"

Equals Fernco 5004 RC Series
 Mission MR04 ARC

New! Concrete to Cast Iron/Plastic

PART NUMBER	SIZE
56644PRC	4"
56664PRC	6" x 4"
56666PRC	6"
56688PRC	8"

Equals Fernco 5006 RC Series
 Mission MR04 ARC

New! AC/Ductile Iron to Cast Iron/Plastic

PART NUMBER	SIZE
565144PRC	4"
565166PRC	6"

Equals Fernco 5051 RC Series
 Mission MR51 ARC

New! AC/Ductile Iron to AC/Ductile Iron

PART NUMBER	SIZE
565544PRC	4"
565566PRC	6"

Equals Fernco 5055 RC Series
 Mission MR55 ARC



• Use PASCO 2SM



Flexible Sewer Saddles

The saddle's elastomeric construction allows a single description to securely fit 6" sewer main pipe diameters and up. The saddle's flexibility eliminates the need for a large inventory of rigid PVC saddles of various descriptions.

Available for all 4" or 6" Plastic or Cast Iron drain pipe inlets in Tee or Wye configurations

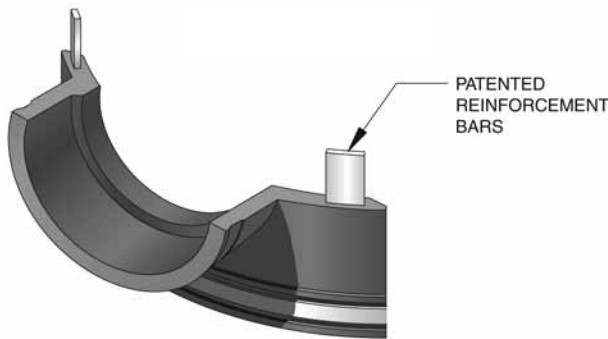

PATENTED REINFORCEMENT BARS

A breakthrough in saddle design, the patented Flexible Saddle demonstrates superior flexibility in more than one way.

- Two configurations, a "Tee" and a "Wye" are available in 4" or 6" inlet descriptions.
- Elastomeric construction provides maximum strength and flexibility.
- Saddle design will accommodate polyethylene pipe used in slip lining sewer systems.
- Inlet range from SCH-40 down to SDR-35 includes standard weight soil pipe.
- Includes special "slip-lock" clamps of 300 series stainless steel.
- Steel reinforced edges prevent distortion when torque is applied to clamps.
- Durable design and low unit price make the Flexible Saddle economical and environmentally wise.

One Flexible Sewer Saddle will fit ALL 6" and larger sewer mains.

PART NUMBER	DESCRIPTION
57144	4" Cast Iron or Plastic Inlet - Tee
57166	6" Cast Iron or Plastic Inlet - Tee
57244	4" Cast Iron or Plastic Inlet - Wye
57266	6" Cast Iron or Plastic Inlet - Wye

Sold with stainless steel inlet clamp and two slip-lock stainless steel clamps for up to 15" sewer mains.

4" inlet clamp #60080

6" inlet clamp #60096

15" sewer main clamps #550248



Test & Clean Out Caps

- Fits plastic and hubless cast iron DWV
- Made from the highest quality natural rubber
- Built in cross rib for extra strength
- Inside knurling grips pipe



PART NUMBER	SIZE
4417	1-1/2"
4418	2"
4419	3"
4422	4"
4840	5"
4841	6"
4849	8"

Knockout Test Caps

- Solvent weld to ABS or PVC DWV
- Fits both plastic SCH 40 and foam core DWV



PART NUMBER	SIZE
4842	1-1/2"
4843	2"
4844	3"
4845	4"



Fill-Test-Drain Cap

“Fill-Test-Drain Cap” Single Size Test Cap with Integral Pipe Nipple

- Multi-use... versatile... economical
- The unique design of these individually sized test caps has a 3/4" MPT x 1/2" FPT pipe nipple molded directly into the caps. Simply add a hose bibb or test gauge to fill, test or drain the line
- Durable 100% synthetic rubber with stainless steel clamp
- Available in 4 sizes... 1-1/2", 2", 3", 4"



* With Hose Bibb

PART NUMBER	SIZES
4857	1-1/2"
4858	2"
4859	3"
4860	4"
*4857HB	1-1/2"
*4858HB	2"
*4859HB	3"
*4860HB	4"



Flip-Cap • Flip & Fill
 Two Test Caps in One

New!

Flip Cap

The “Flip Cap” Dual Size Test Cap...
 Two Test Caps in One!

- One cap - fits two diameters of pipe
- Slide hose clamp to fit
- Multi-use... versatile... economical
- Cut your test cap inventory in half!
- Available in two sizes... 1-1/2" x 2" and 3" x 4"
- “Flip” the cap over and slide the clamp in place to test either diameter of pipe
- Durable 100% synthetic rubber with stainless steel clamp
- Plumber designed and tested

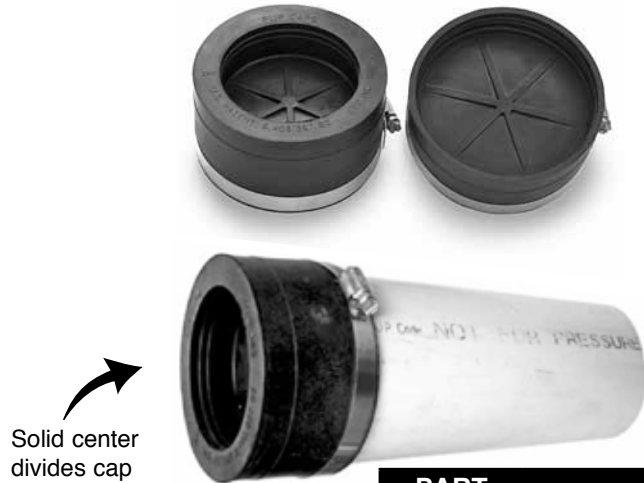

One Cap - 1-1/2" or 2" Pipe
 One Cap - 3" or 4" Pipe

PART NUMBER	SIZES
4848	1-1/2" - 2"
4850	3" - 4"

Flip & Fill Cap

The “Flip & Fill” Dual Size Test Cap
 with Integral Pipe Nipple...
 Two Test Caps in One!

- One cap - fits two diameters of pipe
- Slide hose clamp to fit
- Multi-use... versatile... economical
- Cut your test cap inventory in half!
- Test and drain two pipe diameters with only one cap. The unique design of this cap has a 3/4" MPT x 1/2" FPT pass through nipple molded directly into the cap. Simply add a hose bibb or test gauge to fill, test or drain the line
- Durable 100% synthetic rubber with stainless steel clamp
- Available in two sizes... 1-1/2" x 2" and 3" x 4"
- Plumber designed and tested

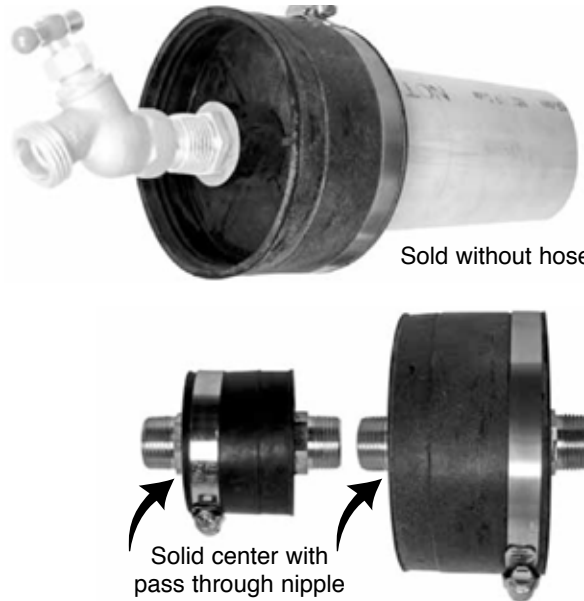

Sold without hose bibb

One Cap - 1-1/2" or 2" Pipe
 One Cap - 3" or 4" Pipe

PART NUMBER	SIZES
4852	1-1/2" - 2"
4854	3" - 4"



COUNTERSUNK-ABS PLASTIC TOP

- Uses a 5/32" allen wrench for installation and removal
- Designed for a "wall flush" finish

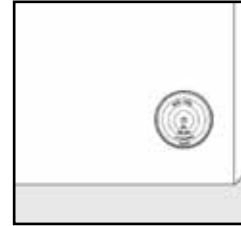

PART NUMBER	DESCRIPTION
CS15	1-1/2" Real-Tite Plug
CS20	2" Real-Tite Plug
CS25	2-1/2" Real-Tite Plug
CS30	3" Real-Tite Plug
*CS35	3-1/2" Real-Tite Plug
CS40	4" Real-Tite Plug



*Most Popular

FLOOR MOUNT-10 GAUGE STAINLESS STEEL TOP

- Uses a 5/32" allen wrench for installation and removal
- Designed for a "floor flush" finish
- Won't "Dimple" from foot or machinery traffic

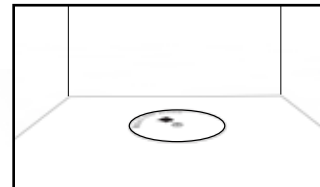

PART NUMBER	DESCRIPTION
STCS15	1-1/2" SS Top Real-Tite Plug
STCS20	2" SS Top Real-Tite Plug
STCS25	2-1/2" SS Top Real-Tite Plug
STCS30	3" SS Top Real-Tite Plug
*STCS35	3-1/2" SS Top Real-Tite Plug
STCS40	4" SS Top Real-Tite Plug



*Most Popular

Econo Test Plug

- Designed with a rubber flange that grips the end of the pipe preventing slippage
- 3" and 4" test plugs supplied with a superfly wingnut.
- For plastic, cast iron DWV



PART NUMBER	SIZE
4801	1"
4802	1-1/4"
4803	1-1/2"
4804	2"
4806	3"
4808	4"



Southern Code Type Brass Cleanout Plugs

- Countersunk plugs can be tapped with 5/16" threads upon request.
- Countersunk plugs may be ordered "not tapped through" by adding -NT to the part number



Raised Head	
PART NUMBER	SIZE
1846	1-1/2"
1847	2"
1848	2-1/2"
1849	3"
1850	3-1/2"
1851	4"
1875	5"
1876	6"

Countersunk Square	
PART NUMBER	SIZE
1852	1-1/2"
1853	2"
1854	2-1/2"
1855	3"
1856	3-1/2"
1857	4"
1878	5"
1879	6"

Countersunk Tapped
1/4" x 20 Threads

PART NUMBER	SIZE
1852-T	1-1/2"
1853-T	2"
1854-T	2-1/2"
1855-T	3"
1856-T	3-1/2"
1857-T	4"

Cleanout Plugs

Brass Cleanout Plugs - UPC Type

- Countersunk plugs can be tapped with 5/16" threads upon request.
- Countersunk plugs may be ordered "not tapped through" by adding -NT to the part number



Raised Head	
PART NUMBER	SIZE
1858	1-1/2"
1859	2"
1860	2-1/2"
1861	3"
1862	3-1/2"
1863	4"
1890	5"

Countersunk Slot	
PART NUMBER	SIZE
1864	1-1/2"
1865	2"
1866	2-1/2"
1867	3"
1868	3-1/2"
1869	4"
1891	5"

Countersunk Tapped
1/4" x 20 Threads

PART NUMBER	SIZE
1864-T	1-1/2"
1865-T	2"
1866-T	2-1/2"
1867-T	3"
1868-T	3-1/2"
1869-T	4"



Cleanout Plug Cover Plate

- Plugs tapped with 1/4" x 20 threads
- Each Set Contains:
- 1-Brass cleanout plug
- 1-Stainless steel cover plate
- 1-1-1/4" x 20 x 4" bolt
- Countersunk plugs may be ordered "not tapped through" by adding -NT to the part number



SC Square Countersunk

PART NUMBER	PLUG SIZE	PLATE SIZE
1779	1-1/2"	3"
1780	2"	4"
1781	2-1/2"	4"
1782	3"	5"
1783	3-1/2"	6"
1784	4"	8"



UPC Slotted Countersunk

PART NUMBER	PLUG SIZE	PLATE SIZE
1785	1-1/2"	3"
1786	2"	4"
1787	2-1/2"	4"
1788	3"	5"
1789	3-1/2"	6"
1791	4"	8"

Stainless Steel Cleanout Cover Plates

- Polished stainless steel
- Countersunk hole will accept both 1/4" and 5/16" bolts
- 22 Gauge metal
- With screw for plastic clean out plugs add -S to part number



**Cover Plate with
1/4" - 20 x 4" bolts**

PART NUMBER	SIZE
1840	3"
1841	4"
1842	5"
1843	6"
1844	7"
1845	8"

Cover Plate ONLY

PART NUMBER	SIZE
1840-C	3"
1841-C	4"
1842-C	5"
1843-C	6"
1844-C	7"
1845-C	8"

Bolts ONLY

PART NUMBER	SIZE
1629	1/4" - 20 x 2-1/2"
1649	1/4" - 20 x 4"
1659	5/16" - 18 x 4"



Domed Stainless Steel Cleanout Plate

- These domes cover cleanouts that protrude from the wall
- Unlike plastic covers these steel plates will not deteriorate with age
- Countersunk hole will accept both 1/4" and 5/16" bolts
- 1-1/4" in depth
- 22 gauge metal

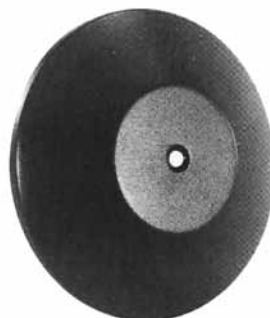

PART NUMBER	DIA.	W/BOLT 1/4" x 20 x 2-1/2"
1796-SS	4"	Yes
1796-SSC	4"	No
1798-SS	6"	Yes
1798-SSC	6"	No





Drum Trap Plate

- 4-1/4" Diameter with gasket
- CP die cast
- 20 Threads
- Fits 3" opening

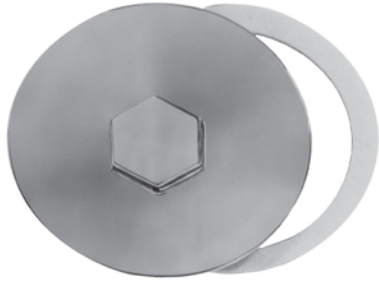

PART NUMBER
1837

Extension Hoses

- Tire pump connections
- 1/4" Male x 1/4" Female swivel
- Note: Any length hose can be ordered. Please call for quote.



PART NUMBER	LENGTH
4759-2	2 ft.
4759-3	3 ft.
4759-4	4 ft.
4759-5	5 ft.
4759-6	6 ft.

Eureka Cleanout Plug Wrench

- This unique tool fits either slotted or square countersunk cleanout plugs
- Strong, malleable iron
- Fits slotted or square

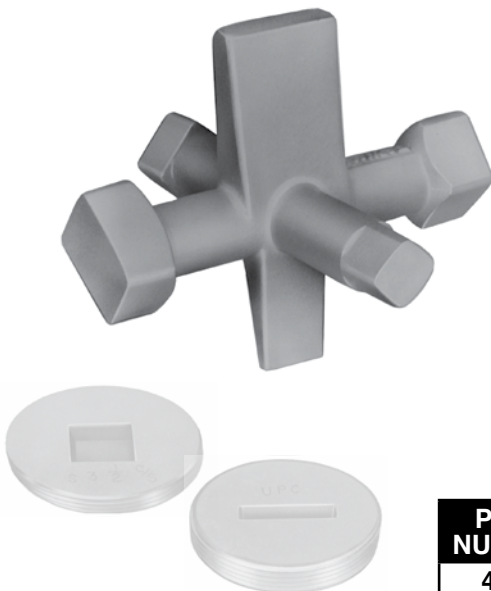

PART NUMBER
4567

Cut Length Oakum Oiled or White

- Convenient, labor saving cut lengths
- Non-spitting
- Contains no tar
- Made to pack well, caulks tight
- Treated with a special compound to expand when wet



Oil Treated

PART NUMBER	DESCRIPTION
2899	1 bag with 3 strands - 27"
2897	Small box w/ 12 strands of 27" lengths
2898	Large case with 10 boxes of #2897

White - No Oil

PART NUMBER	DESCRIPTION
28100	1 bag with 14 strands - 27"



2" Quick Connect Shower Drain

Quick Clamping Gasket And Collar For Ceramic Tile Showers

- Cast Iron
- Clamping collar securely attaches drain to drain line
- Speeds installation
- Extra heavy (.050) strainer



Protected with
 TechCoat finish

PART NUMBER	TOP FLANGE DIAMETER	BOTTOM FLANGE DIAMETER
7990	5-1/2"	7"

"Quick Test" Shower Drain

For Ceramic Tile Showers

- Threaded for test nipple
- Cast iron
- Extra heavy (.050) strainer



PART NUMBER	DRAIN CONNECTION
8006	2" IPS
8007	1-1/2" IPS
8008	2" Caulk
8011	2" Caulk w/Gasket
8012	2" No Hub

Protected with
 TechCoat Finish

PART NUMBER	DESCRIPTION
8009	Quick Caulk Rubber Gasket Only

2" Quick Set Shower Drain

For Ceramic Tile Showers

- Internal locknut and gasket for 2" DWV
- Cast Iron
- Extra heavy (.050) strainer



Internal locknut &
 gasket

Protected with
 TechCoat Finish

PART NUMBER	TOP FLANGE DIAMETER	BOTTOM FLANGE DIAMETER
8014	5-1/2"	5-1/2"

Plastic Shower Drain

Clamping Ring Style

- 4" diameter strainer
- 2" IPS plastic tailpiece allows adjustment to desired level
- Fits over 2" or inside 3" Schedule 40 DWV



PART NUMBER	MATERIAL	DRAIN CONNECTION	TOP FLANGE DIAMETER	BOTTOM FLANGE DIAMETER
8015	PVC	2"-3" PVC	5-1/4"	6-1/2"
8016	ABS	2"-3" ABS		
8019	4" Stainless Steel Strainer			



Shower & Floor Drain-Round

- Adjustable strainer
- Cast Iron
- 4-3/16" Heavy chrome plated brass strainer with brass spud



PART NUMBER	DRAIN CONNECTION	TOP FLANGE DIAMETER	BOTTOM FLANGE DIAMETER
60201	2" Inside Caulk	5"	7"
60203	2" IPS		
60205	2" No-Hub		
60981	4-3/16" threaded chrome plated brass strainer only		

Shower & Floor Drain-Square

- Adjustable strainer
- Cast Iron
- 4-3/16" Heavy chrome plated brass strainer with brass spud



PART NUMBER	DRAIN CONNECTION	TOP FLANGE DIAMETER	BOTTOM FLANGE DIAMETER
60201-SQ	2" Inside Caulk	5"	7"
60203-SQ	2" IPS		
60205-SQ	2" No-Hub		
60981-SQ	4-3/16" threaded chrome plated brass strainer only		

Shower & Floor Drain

- Adjustable strainer
- PVC with chrome brass top & ABS with chrome brass top
- 4-3/16" Heavy chrome plated brass strainer



PART NUMBER	DESCRIPTION
8017	2X3 PVC/Brass Shower Drain w/Round Head Top
8018	2X3 PVC/Brass Shower Drain w/Square Head Top
8021	2X3 ABS/Brass Shower Drain w/Round Head Top
8022	2X3 ABS/Brass Shower Drain w/Square Head Top



Cast Iron Closet Flanges

All cast iron closet flanges are protected by PASCO'S exclusive TechCoat Finish

“Quick Set”

Push on either cast iron or plastic DWV. Stainless steel bolts and washers tighten neoprene gasket.



REGULAR STYLE

PART NUMBER	SIZE & DEPTH
40320	3" x 2"
40420	4" x 2"
40440	4" x 4"

WEST COAST STYLE Has Built In Test Cap

PART NUMBER	SIZE & DEPTH
296	4" x 2"
297	4" x 3"
298	4" x 4"



2" Offset Caulk - No Hub



PART NUMBER	SIZE & DEPTH	CONNECTION
43441	4" x 4"	No-Hub

3/4" Offset Quick Set

Offsets to front or back



PART NUMBER	SIZE & DEPTH
299	4" x 2"

4" Brass Closet Flanges



49440



49443



49441

For use with lead bends

PART NUMBER	SIZE & DEPTH	STYLE
49440	4"	14oz.
49441	4"	1-1/8" Deep
49443	4" x 1-1/2"	3" Reducing



2" Quick Set Shower Drain

For Fiberglass Shower Stalls

- Internal locknut and gasket for 2" DWV
- Brass body and locknut
- Stainless steel strainer



PART NUMBER	PIPE SIZE
7980	2"

Brass Utility Drain



PART NUMBER	IPS
1170	1-1/2"
1171	2"

WingTite Shower Drain

- Use in fiberglass or plastic showers
- Clear visual instructions to remove the old drain
- Shower tear-out eliminated
- Fits 2" ABS & PVC Pipe
- Most repairs done in less than 30 minutes
- Allows one-person shower installations
- Drain installs AFTER shower stall is set



PART NUMBER
SD1000



QUICK SET SQUARE CAST IRON CLOSET FLANGE

The Problem:

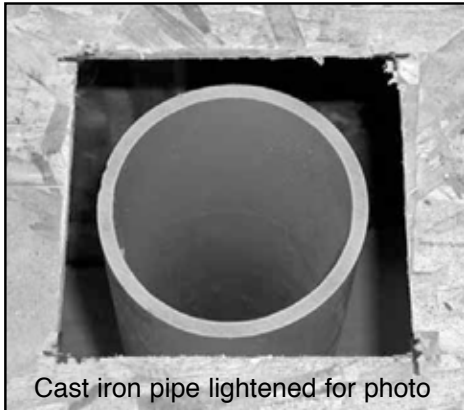

Cast iron pipe lightened for photo

In new construction, contractors everywhere find it easier to cut square holes rather than round holes for DWV pipe and closet flanges.

However, the holes in the subfloor must be cut larger than the pipe to allow the closet flange to be pushed onto the pipe.



In the majority of installations too much wood has been removed to properly secure a round closet flange.

The Solution:



PASCO's NEW Quick Set Square Closet Flange will solve the problem of properly supporting a closet flange mounted in a square hole. Keep in mind that the pipe doesn't support the flange, the sub-floor does. Simply push the QUICK SET CLOSET FLANGE flush on the DWV pipe and alternately tighten the four stainless steel screws. Secure to subfloor with brass wood screws.

**PART
NUMBER**
295



Closet Flange Spacer

Patent Pending

Provides stability to closet flanges installed in oversized or irregular cut holes in the subfloor

- Installs below the closet flange
- Snugly fits PVC, ABS and, Cast Iron closet flanges
- Cut away inner ring to fit the larger OD of a cast iron closet flange
- 10" square, 3/8" thick
- Can be stacked for added height when floor is to be finished with ceramic tile
- Supplied with four brass wood screws
- Corrosion proof polyethylene
- **Two styles to fit any closet flange**

The Problem:

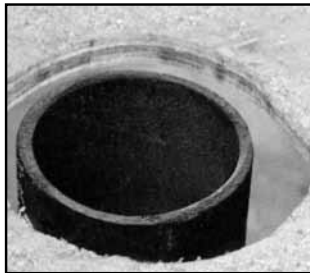

The hole in the wooden subfloor is cut too large to properly secure a closet flange.

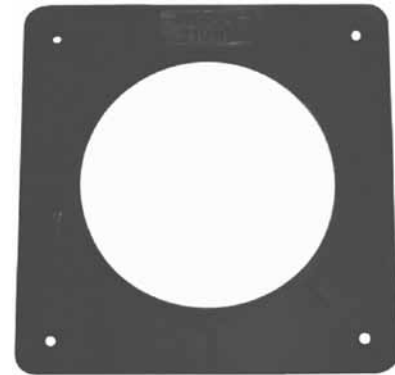

The Solution:



With the new PASCO Closet Flange Spacer you can fix this problem quickly, efficiently, and professionally.

Packed 20 per case

PART NUMBER	FITS CLOSET FLANGE STYLE
21016	Regular-ABS, PVC, Cast Iron

Bell Traps

- Protected with TechCoat Finish



Complete Bell Trap

PART NUMBER	DESCRIPTION
76302	6" x 6" x 2" No-Hub

Strainer Only

PART NUMBER	DESCRIPTION
76412	4-7/8" for 6" x 6"



Sump Pump Check Valves

- Flapper is nested in place to improve durability and longer life.
- Gasket-less design used on valve body.
- Injection molded ABS valve body is extremely tough and durable.
- Internal valve chamber uses a hydrodynamic design to reduce water turbulence and reduce noise.
- Silencer check valves completely eliminate hammering noises associated with pump cycling.
- Vertical or Horizontal

Rubber Hose Coupling



- Valves come with all mounting hardware.

Standard

PART NO.	HOSE SIZE	LENGTH
29150	1-1/2"	7-3/4"
29126	1-1/4" x 1-1/2"	9-1/4"

Full Flow

PART NO.	HOSE SIZE	LENGTH
29120	2"	9-3/4"

"Silencer"

PART NO.	HOSE SIZE	LENGTH
29121	1-1/2"	12"
29122	2"	12-3/4"

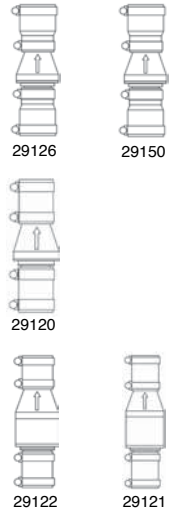

True Union Swing



- True Union coupling for easy swing-out during service/inspection
- Slip x Slip ends • O-Ring seals
- Ball valve/check valve combinations

"Silencer" Ball Valve / Check Combo

PART NO.	HOSE SIZE	LENGTH
29137	1-1/2"	14-1/8"
29138	2"	16-1/2"

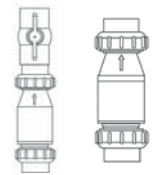

Compression Swing



- Fittings on both ends of valve for easy installation
- Ball valve/check valve combinations available
- No gluing required
- Heavy duty design

Compression

PART NO.	PIPE SIZE	LENGTH
29139	2"	9-1/4"