

COMMERCIAL

CATALOGUE



SAVING WATER – ONE FAUCET AT A TIME

For years, Delta Faucet has led the industry in sustainability by using environmentally responsible manufacturing processes and creating newer, greener technologies and products.

We have also partnered with the U.S. EPA WaterSense® Program to protect and conserve our water supply. We were honoured to be named a WaterSense® Manufacturer Partner of the Year in 2013, 2014 and 2015 – and as a WaterSense® Sustained Excellence Award winner in 2016, 2017 and again in 2018.

Delta Faucet products can contribute to a sustainable building and contribute towards LEED® certification.



WATER-EFFICIENT PRODUCTS

Lavatory Faucets: flow rate of 1.5 or 1.8 gpm @ 60 psi (5.7 or 6.8 L/min @ 414 kPa) versus Industry Standard ASME A112.18.1/CSA B125.1 of 2.2 gpm @ 60 psi (8.3 L/min @ 414 kPa).

Flush Valves: water closet flush valves of 1.1 or 1.27 gpf (4.2 or 4.8 Lpf) and urinal flush valves of 0.5 gpf (1.9 Lpf) versus Industry Standard ASME A112.19.2/CSA B45.1.

Shower Heads and Hand Showers:
Flow rate of 1.5, 1.75 or 2.0 gpm @ 80 psi (5.7, 6.6 or 7.6 L/min @ 552 kPa) versus Industry Standard ASME A112.18.1/CSA B125.1 of 2.5 gpm @ 80 psi (9.5 L/min @ 552 kPa).



WaterSense® is a registered trademark of the U.S. Environmental Protection Agency.

LEED® is a registered trademark of the U.S. Green Building Council.



WE ARE DELTA FAUCET

We are at the cutting edge of product innovation and customer satisfaction. But we've been there for over 50 years now, so we know exactly what it takes to stay there.

We understand the unique demands of the commercial market. Our products go beyond excellent design to incorporate smart thinking and exceptional performance that stand the test of time, even in the most challenging environments.

To the contractor, plumber or specifier, it can seem like each Delta® product was made with their project in mind. That's because we listen closely to what our customers want and need, invest in extensive research and design, and apply intelligent technological solutions that really do make their jobs easier.

See what Delta can do.SM



DELTA® COMMERCIAL PRODUCTS AT WORK



PUBLIC FACILITIES

Delta® commercial products are designed to withstand use and abuse in heavy traffic areas. Shopping centres, office buildings, entertainment venues and airports – we're everywhere and built to last!

EDUCATION

From pre-school to postsecondary, faucets and flush valves are an integral part of educational facilities. We have designed our products with these demanding environments in mind, with features such as hands-free activation, built-in vandal resistance and easy-clean surfaces.

HOSPITALITY

Our products help your guests unplug. As you look for new and better ways to distinguish your properties from the competition, please allow us to help pamper your guests. Or as we like to call them, repeat customers.

HEALTHCARE

We have been serving the needs of the healthcare industry for decades, and we understand the unique issues of this ever-changing market. This is reflected not only in our innovative products, but also in our responsiveness to your needs when building or upgrading your facility.

LONG-TERM CARE

We are serious about the principles behind accessibility and safety, so we make them key priorities. Our wide assortment of ADA-compliant and thermostatic products bring ease-of-mind for assisted living and long-term care facilities.



How to use this catalogue

Look for these icons throughout the catalogue to easily identify key features of our commercial products.

 = Proximity® Sensing Technology

 = H₂Optics® Sensing Technology

 = H₂Okinetic® Technology

 = DIAMOND® Valve

 = EZ Adjust® System

 = WaterSense® Labeled Product
WaterSense® is a registered trademark of the U.S. Environmental Protection Agency.

 = Water-Efficient Product

 = ADA-Compliant Product



Our five-year limited warranty on most commercial installations allows you to specify with confidence.

We put our products through a punishing regimen of durability testing, allowing us to stand behind them with a comprehensive warranty.

TABLE OF CONTENTS

- INNOVATIVE SOLUTIONS**4
- TECK® AND HDF® FEATURES**8
- LAVATORY FAUCETS**
- Making a Statement in the Lavatory10
- Electronic12
- Single-Handle16
- Two-Handle18
- Metering20
- FLUSH VALVES**
- Electronic & Options22
- Manual24
- HEALTHCARE SPECIALTIES**
- Designed with Hygiene in Mind26
- Surgeon Scrub-Up28
- Laboratory30
- SINK FAUCETS**
- Style and Comfort with ADA Compliance32
- Single-Handle34
- Two-Handle36
- Wall-Mount38
- GRAB BARS**40
- SHOWERING**
- MultiChoice® Universal Rough-in42
- Tub & Shower43
- Shower heads44
- DRAINAGE**44
- WEB**45

Product availability and configuration are subject to change without notice.

INNOVATIVE SOLUTIONS



PROXIMITY® SENSING TECHNOLOGY

The entire faucet body acts as a sensor, activating water flow when hands approach and stopping once hands are removed. The reliable hands-free activation responds extremely fast regardless of lighting, reflections and approach direction.

Products featuring Proximity® Sensing Technology are ideal for tough conditions requiring superior vandal resistance as well as ease of cleaning and maintenance.



H₂OPTICS® TECHNOLOGY

One of the most advanced infrared sensing technologies in the industry today for electronic faucets and flush valves.

Using the principles of triangulation, H₂Optics® Technology accurately calculates the distance from the user to operate dependably and consistently, regardless of interference factors such as dark clothing or lighting conditions.

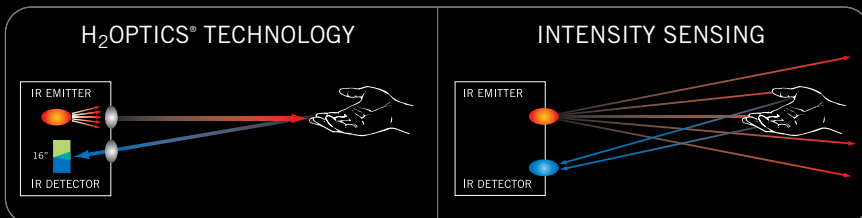

SOLAR TECHNOLOGY

Delta® solar electronic faucets and flush valves feature top-mounted solar energy modules that harness ambient light energy to assist the batteries in operation of the unit. This allows the faucet or flush valve to respond quickly and reliably in natural, artificial, minimal and occupancy lighting – or none at all.

With robust construction and a variety of vandal-resistant features, Delta® solar electronic products excel in a wide range of commercial, public and institutional facilities.

Delta® solar electronic products provide the sustainability of solar power, reliability of batteries and ease of installation & maintenance. And with Delta Faucet's 5-year limited warranty, Delta® solar electronic products offer quality AND peace of mind.



THERMOSTATIC
CARTRIDGE



ADJUSTABLE
LIMIT STOPS



TEMPERATURE
ADJUSTMENT

ELECTRONIC THERMOSTATIC FAUCET

A thermostatic mixing valve inside the faucet body prevents the water from exceeding 120°F (49°C), satisfying the temperature-limiting requirements of ASSE 1070.

The thermostatic mixing valve and supply lines are integrated into the faucet itself. This all-in-one design minimizes installation time and reduces the number of potential leak points.

The DEMD-611LF features reliable, hands-free activation, a convenient top mixer, and a 15-second run time, making it an ideal handwash faucet for healthcare, education and public facility applications.

INNOVATIVE SOLUTIONS

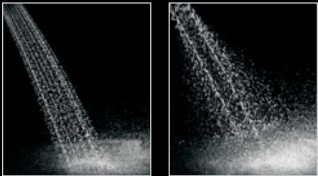

MORE COVERAGE*

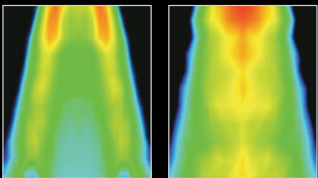

MORE WARMTH

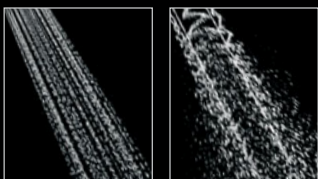

MORE INTENSITY

Standard Shower

H₂Okinetic® Shower

H₂OKINETIC® TECHNOLOGY

The feeling of more water, without using more water.

Larger water droplets and a dense spray pattern result in a warmer shower experience, while the unique wave pattern and high velocity of the water create the feeling of more pressure. And all this happens without any internal moving parts that could break or degrade over time. At a flow of just 1.5 gpm @ 80 psi (5.7 L/min @ 552 kPa), H₂Okinetic® Technology is environmentally smart, contributing to a reduction in utility costs and awarding points towards LEED® certification.

Water enters the chamber and flows through highly engineered channels, which control the shape, size and velocity of the water droplets.

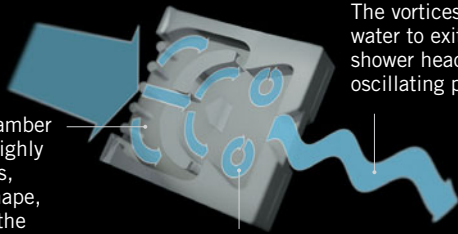

The vortices allow water to exit the shower head in an oscillating pattern.

At the bottom of the chamber, the water forms vortices.

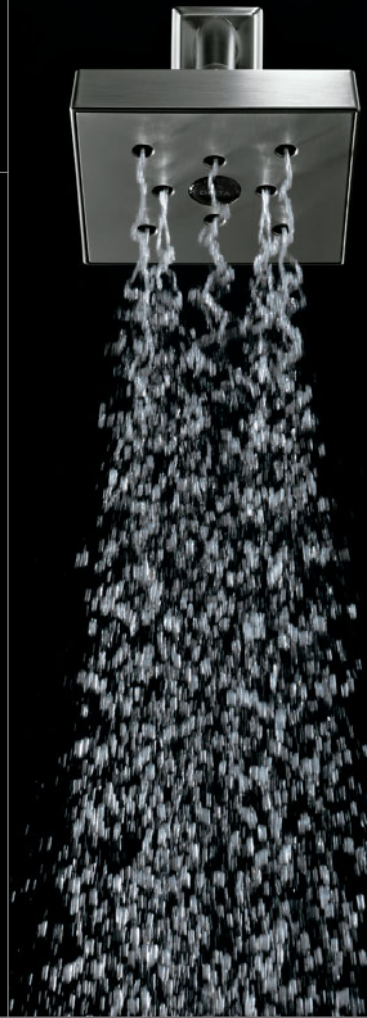

MULTICHOICE® UNIVERSAL ROUGH-IN

One rough. Unlimited possibilities. MultiChoice® Universal rough-in provides the flexibility to upgrade the style or functionality of showers without altering the plumbing behind the wall. Saves time and hassle—streamlining the whole plumbing and installation process while eliminating the opportunity for the wrong valve in the wall.



*Coverage measured in accordance with EPA WaterSense® specification for shower heads, March 4, 2010.

LEED® is a registered trademark of the U.S. Green Building Council.

TEMPASSURE®

THERMOSTATIC VALVES

Water that is too hot can scald skin in the shower and pose a safety hazard. TempAssure® Thermostatic valves keep the water in the shower within a safe $\pm 3.6^\circ\text{F}$ ($\pm 2^\circ\text{C}$).

An adjustable handle limit stop eliminates the worry that an individual may set the water too hot for comfort. It's an ideal solution for hospitals and long-term care facilities.





DIAMOND® VALVE

Utilizing a diamond-coated ceramic disc, the DIAMOND® valve is built to last up to 10 times the industry standard.* The diamond-embedded ceramic disc constantly polishes the uncoated ceramic disc, preventing calcium and mineral deposits from building up and ensuring smooth, consistent operation over the life of the faucet.

**Industry standard based on ASME.A112.18.1 of 500,000 cycles.*

BATTERY BACKUP

Allowing hardwire units to continue operating during power outages by switching the supply to a 9-Volt battery until power is restored. Available for use with a wide variety of our electronic faucets and flush valves.

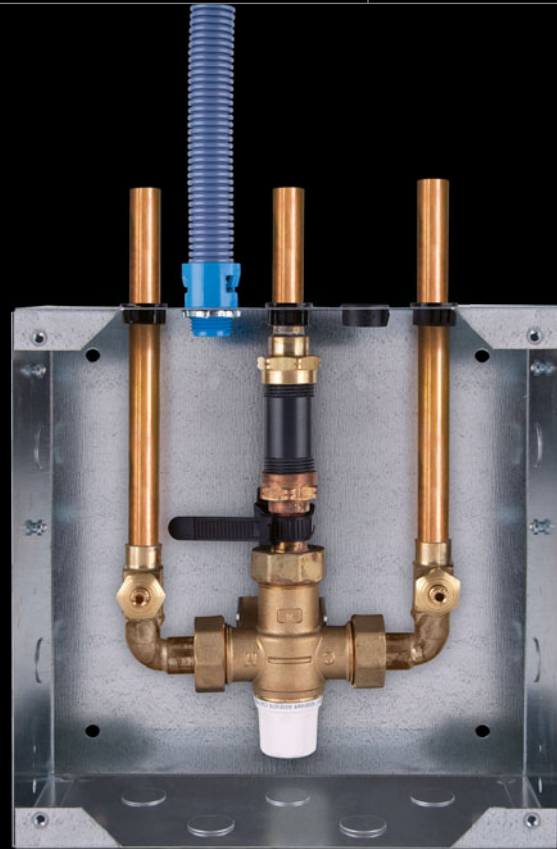

DELTA® PREASSEMBLED FAUCET ROUGHS

Available with or without a thermostatic mixing valve, these recessed-mount roughs are pre-plumbed and factory-tested, saving you installation time. Purchasing roughs and trims separately allows you to order and install what you need, when you need it. Available with many of our Proximity® Sensing Technology and H₂Optics® electronic faucets.

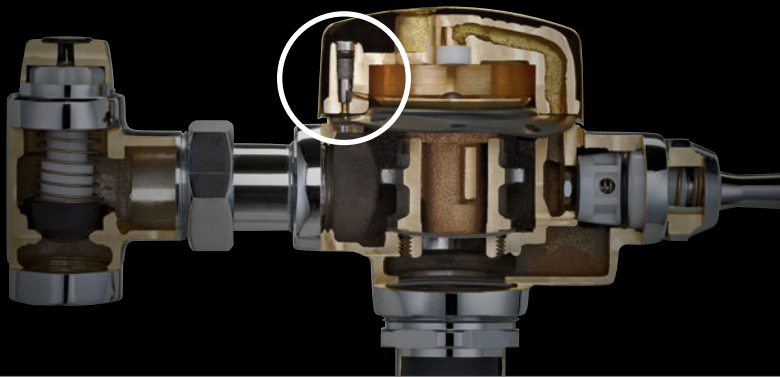

EZ ADJUST®

A simple turn of an external adjustment screw is all that is needed to set or fine tune flush volumes. There is no need to turn off water supply lines or replace internal parts to adjust flow rates. EZ Adjust® technology allows Delta® flush valves to have a consistent performance on a broad assortment of fixtures.

PRODUCTS THAT WORK FOR YOU

TECK® SERIES—HEAVY-DUTY SOLUTIONS

The Delta® TECK® series of products are designed for demanding institutional and commercial environments where robust features are required.

HDF® SERIES—FOR LIGHT COMMERCIAL APPLICATIONS

Our HDF® series of products is engineered with ADA compliance and vandal resistance front of mind, providing you with the perfect option for light commercial applications.

DELTA® CER-TECK® AND TUF-TECK® CARTRIDGES



Better ideas that mean fewer troubles. We develop product innovations that provide unsurpassed reliability for years of trouble-free performance, like our CER-TECK® and TUF-TECK® cartridges, which you'll find at the heart of our two-handle faucets.

CER-TECK® CERAMIC DISC CARTRIDGE



TUF-TECK® COMPRESSION CARTRIDGE

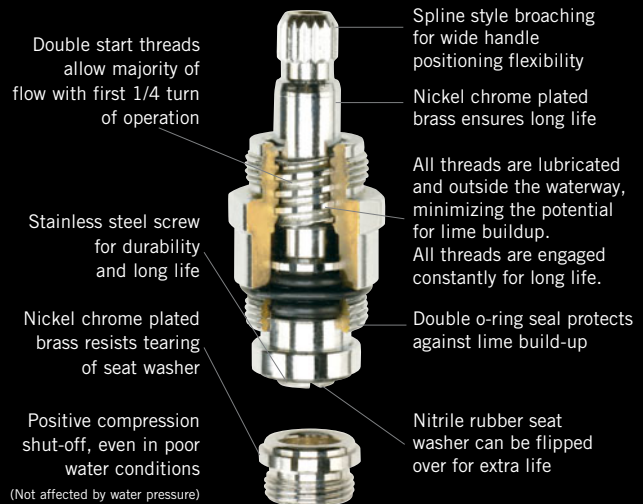

HANDLE OPTIONS

A variety of handle variations—including lever, blade and ADA options in multiple sizes—to fit almost any application.



SPOUT OPTIONS

Finding the right spout for unique installations is never a problem with the Delta® TECK® series. We offer several choices, including rigid, swing and limited swing options.

LIMITED SWING GOOSENECK SPOUTS

Our limited swing gooseneck spouts use a solid brass stop to limit movement of the spout to 120° total rotation.

SWING SPOUTS

Swing spout options vary with 5 solutions to choose from.

RIGID / SWIVEL SPOUTS

Offering 9 rigid / swivel spout options.

OUTLET OPTIONS

The TECK® series offers a wide selection of outlets with flow rates ranging from 0.35 gpm (1.32 L/min) to 2.2 gpm (8.3 L/min). Choose from a variety of streams—laminar, spray or aerated.

LAMINAR FLOW SMOOTH END SPOUT

The smooth end of the spout is chrome-plated with no crevices and the flow control remains under a column of water at the base of the spout, helping prevent the buildup of contaminants.

MICROBE-INHIBITING OUTLET

Ideal for healthcare applications, this outlet offers a unique combination of features, including a laminar stream, screenless construction and an Agion® antimicrobial finish.

Agion® is a registered trademark of Agion Technologies Inc.



LAVATORY FAUCETS



MAKING A STATEMENT IN THE LAVATORY



Whether it's enhancing the ambience of an elegant hotel restroom with hands-free functionality, or providing single-handle convenience in a public restroom, Delta® faucets make a statement all their own. The faucets become the focal point of each room, providing the particular look, feel and response required—enhancing people's experience with water.

In the pages that follow, you'll see a complete range of lavatory faucets and flush valves for virtually every application. Let Delta Faucet help you make a statement in your building.

LAVATORY FAUCETS – ELECTRONIC

590TP0150



Water-Efficient Outlets

Available reduced flow outlets, ranging from 0.35 gpm @ 60 psi (1.32 L/min @ 414 kPa) to 1.5 gpm @ 60 psi (5.7 L/min @ 414 kPa).

Metering and Line Rinse Features

All of our Proximity® and H₂Optics® Technology faucets feature programmable metering and periodic line rinse functionality.

Available Battery Backup

Our battery backup module (sold separately) allows hardwire units to continue operating during power outages, by switching to power from a 9-Volt battery until power is restored. Available for use with the following series: 590T, 590TP, 590LF-HDF, 590-PLGHDF, 591T, 591TP, 591LF-HDF, 591-PLGHDF, 592-PLGHDF, 620TP, 630TP, 1500T, 1600T, 81T-HWA and 81T-WMSHWA.



SINGLE-HOLE FAUCET WITH PROXIMITY® SENSING TECHNOLOGY

630TP Series – Hardwire
631TP Series – Battery

- Available outlet options ranging from 0.35 to 1.5 gpm (1.32 to 5.7 L/min)
- WaterSense® listed models available
- Surface mounted control box
- Mixing valve required (order separately)
- Optional 4" coverplate available
- Chrome or Brilliance® Stainless finish



SINGLE-HOLE GOOSENECK FAUCET WITH PROXIMITY® SENSING TECHNOLOGY

620TP Series – Hardwire
621TP Series – Battery

- Forged brass body
- Available outlet options ranging from 0.5 to 2.2 gpm (1.9 to 8.3 L/min)
- WaterSense® listed models available
- Surface mounted or recessed control box options
- Optional 4" coverplate available
- Chrome, Brilliance® Stainless or Matte Black finish



SINGLE-HOLE HIGH-RISE FAUCET WITH PROXIMITY® SENSING TECHNOLOGY

590TPO Series – Hardwire
590TP1 Series – Battery

- Cast brass body
- Available outlet options ranging from 0.35 to 1.5 gpm (1.32 to 5.7 L/min)
- WaterSense® listed models available
- Surface mounted or recessed control box options
- Optional 4" or 8" coverplates available
- Chrome finish



4" CENTRESET FAUCET WITH PROXIMITY® SENSING TECHNOLOGY

591TPO Series – Hardwire
591TP1 Series – Battery

- Cast brass body
- Available outlet options ranging from 0.35 to 1.5 gpm (1.32 to 5.7 L/min)
- WaterSense® listed models available
- Surface mounted or recessed control box options
- Chrome finish



SINGLE-HOLE FAUCET WITH PROXIMITY® SENSING TECHNOLOGY

590-PLGHDFHW – Hardwire
590-PLGHDF – Battery

- All metal faucet construction
- 0.5 gpm (1.9 L/min) laminar outlet
- Surface mounted control box
- Mixing valve required (order separately)
- Optional 4" or 8" coverplates available
- Chrome finish

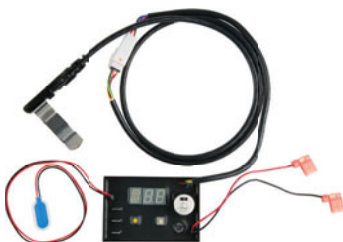

RETROFIT KIT FOR PROXIMITY® FAUCETS 061271A

- Upgrade existing (2014 and earlier) 590TP, 591TP and 590-PLGHDF Series faucets
- No faucet trim changes required
- Retrofit kit includes controller, snap-on sensor clip and ground wire for hardwire installations

Batteries included with battery-operated models.

Order transformer separately for hardwire models.

Order battery back-up separately for hardwire models.

WaterSense® listed models also available.

**Not applicable to 2.2 gpm (8.3 L/min) outlets.*



SINGLE-HOLE HIGH-RISE FAUCET WITH H₂OPTICS® TECHNOLOGY

590T0 Series – Hardwire

590T1 Series – Battery

- Cast brass body
- Available outlet options ranging from 0.35 to 1.5 gpm (1.32 to 5.7 L/min)
- WaterSense® listed models available
- Surface mounted or recessed control box options
- Optional 4" or 8" coverplates available
- Chrome finish



4" CENTRESET FAUCET WITH H₂OPTICS® TECHNOLOGY

591T0 Series – Hardwire

591T1 Series – Battery

- Cast brass body
- Available outlet options ranging from 0.35 to 1.5 gpm (1.32 to 5.7 L/min)
- WaterSense® listed models available
- Surface mounted or recessed control box options
- Chrome finish



SINGLE-HOLE FAUCET WITH H₂OPTICS® TECHNOLOGY

590LF-LGHGMHDF – Battery

- All metal faucet construction
- 0.5 gpm (1.9 L/min) laminar outlet
- Surface mounted control box
- Mixing valve required
- To convert from battery to hardwire, order 060683A
- Chrome finish



590T0150



4" CENTRESET FAUCET WITH H₂OPTICS® TECHNOLOGY

591LF-LGHGMHDF – Battery

- All metal faucet construction
- 0.5 gpm (1.9 L/min) laminar outlet
- Surface mounted control box
- Mixing valve required
- To convert from battery to hardwire, order 060683A
- Chrome finish



Batteries included with battery-operated models.

Order transformer separately for hardwire models.

Order battery back-up separately for hardwire models.



WaterSense® listed models also available.



SINGLE-HOLE SOLAR ELECTRONIC FAUCET

- DEMD-320LF – For cold or premixed water
- DEMD-321LF – With side mixer
- Solar-powered, user-activated infrared sensor
- Single hole installation
- Vandal-resistant hidden spray outlet
- Solenoid powered by four 1.5V “AA” batteries (required and included)



SINGLE-HOLE ELECTRONIC THERMOSTATIC FAUCET

- DEMD-611LF – 0.66 gpm (2.5 L/min)
0.17 gal/cycle (0.64 L/cycle)*
- DEMD-611-10LF – 1.0 gpm (3.8 L/min)
0.25 gal/cycle (0.94 L/cycle)*
- ASSE 1070 compliant
- Above deck mixing valve and electronics
- Integrated supply lines
- Single hole installation
- Mixing handle to adjust temperature
- Adjustable comfort limit stop



*Based on 15 second max run time



SINGLE-HOLE FAUCET

- DEMD-101LF – For cold or premixed water
- DEMD-111LF – With side mixer
- DEMD-112LF – With technicians' mixer
- Battery operated
- Above deck solenoid and battery
- 0.5 gpm (1.9 L/min) vandal-resistant wrench flat spray outlet
- Chrome or Nickel Stainless finish
- DEMD-112LF available in Chrome only



SINGLE-HOLE FAUCET

- DEMD-201LF – For cold or premixed water
- DEMD-211LF – With side mixer
- DEMD-212LF – With technicians' mixer
- Battery operated
- 0.5 gpm (1.9 L/min) vandal-resistant wrench flat spray outlet
- Chrome or Nickel Stainless finish
- DEMD-212LF available in Chrome only



SINGLE-HOLE FAUCET

- DEMD-301LF – For cold or premixed water
- DEMD-311LF – With side mixer
- DEMD-312LF – With technicians' mixer
- Battery operated
- 0.5 gpm (1.9 L/min) vandal-resistant wrench flat spray outlet
- Chrome or Nickel Stainless finish
- DEMD-312LF available in Chrome only



SINGLE-HOLE WALL-MOUNT FAUCET

- DEMD-402LF (8.0" Spout) – Hardwire
- DEMD-404LF (6.0" Spout) – Hardwire
- Tempered water supply by others
- Forged brass body
- 0.5 gpm (1.9 L/min) vandal-resistant flow control spray outlet
- Transformer required, order separately
- No conversion to battery possible



SINGLE-HOLE ELECTRONIC SOAP DISPENSER

- DESD-750 – Plug-in
- DESD-751 – Battery
- Cast brass, chrome-plated spout
- 1,000 ml (33.8 oz) refillable soap bottle (soap not included)
- Soap dispensing quantity adjustable with optional remote (order separately)
- Anti-rotation pin
- DESD-750 – Plug-in power supply (120 VAC to 12 VDC), included
- DESD-751 – Battery powered, batteries included



SINGLE-HOLE ELECTRONIC SOAP DISPENSER

- DESD-550 – Battery, All-Cast Body
- DESD-250 – Battery, Non-Metal Version
- Solid machined shank with low profile spout
- Standard 800 ml soap bottle
- Fits on decks up to 2" thick
- LED indicators: Yellow = low battery, Red = low soap
- Hardwire kit available



OPTIONAL REMOTE CONTROL
060967A

- The sensor and flow time settings for the faucets on this page (excluding DEMD-320LF) can be adjusted with this optional remote control.
- Can also be used with DEMD-86505 (Electronic Washdown Urinal Flush Valve), shown on page 23.

To convert faucets on this page from battery to hardwire, see series-specific page on specselect.com.

LAVATORY FAUCETS – SINGLE-HANDLE

22C601



Ceramic Disc Technology

This low-maintenance washerless faucet offers the smooth operation of ceramic technology. The volume and temperature control is integrated so the faucet can be turned on in the same position as it was turned off for consistent temperature setting.

Water-Efficient Outlet

Available in four optional reduced flow outlets, ranging from 0.35 gpm @ 60 psi (1.32 L/min @ 414 kPa) to 1.5 gpm @ 60 psi (5.7 L/min @ 414 kPa).

Longer Reaching Spout

This longer reaching spout provides a 5 ³/₄" reach compared to the industry standard of 4". This reduces the chance of the user's hands touching the back of the sink and the amount of water pooling on the counter.

Solid Cast Brass Body

The one-piece solid cast brass construction makes this faucet seamless for easy cleaning.



4-16" WIDESPREAD SINGLE CONTROL FAUCET

- 24T2643 – Stainless Steel Ball
- Vandal-resistant 6" elbow lever handle
 - Solid brass fabricated body
 - Adjustable handle limit stop
 - 1.5 gpm (5.7 L/min) standard flow control aerator



4" CENTRESET FAUCET
22C101 – Ceramic Disc

- Cast brass body
- Vandal-resistant lever handle
- Adjustable handle limit stop
- 1.5 gpm (5.7 L/min) vandal-resistant wrench flat flow control outlet



4" CENTRESET FAUCET
501LF-HGMHDF – Diamond Coated Ceramic Disc

- All metal fabricated body
- Vandal-resistant lever handle
- Adjustable handle limit stop
- 0.5 gpm (1.9 L/min) vandal-resistant flow control spray outlet



4" CENTRESET FAUCET
515LF-HDF – Diamond Coated Ceramic Disc

- All-metal fabricated body
- Includes metal pop-up
- Vandal-resistant 6" elbow handle
- Vandal-resistant outlet
- Adjustable handle limit stop
- 1.5 gpm (5.7 L/min) vandal-resistant flow control aerator



4" CENTRESET FAUCET
22C131 – Ceramic Disc
22C331 – Ceramic Disc, with Metal Pop-Up

- Cast brass body
- Vandal-resistant lever handle
- Adjustable handle limit stop
- 1.5 gpm (5.7 L/min) vandal-resistant flow control aerator



SINGLE-HOLE FAUCET
22C631 – Ceramic Disc
22C831 – Ceramic Disc, with Metal Pop-Up

- Cast brass body
- Vandal-resistant lever handle
- Adjustable handle limit stop
- 1.5 gpm (5.7 L/min) vandal-resistant flow control aerator



SINGLE-HOLE FAUCET
570LF-WFHDF – Stainless Steel Ball

- Solid brass fabricated body
- 4" long spout swings 360°
- Vandal-resistant lever handle
- Adjustable handle limit stop
- 1.2 gpm (4.5 L/min) vandal-resistant flow control aerator



SINGLE-HOLE FAUCET
570LF-06ELH – Stainless Steel Ball

- Solid fabricated brass body
- 6" long spout swings 360°
- Vandal-resistant elbow lever handle
- Adjustable handle limit stop
- 1.2 gpm (4.5 L/min) vandal-resistant flow control aerator



LAVATORY FAUCETS – TWO-HANDLE

23C624-T1



Solid Brass Spout

Compared to traditional tubular spouts on the market, our solid brass spout boasts a .09" wall thickness which provides superior force resistance—making it difficult for would-be vandals to cause damage.

Limited Swing Gooseneck

Available in multiple sizes, the limited swing gooseneck option limits movement of the spout in 15° increments to a maximum 120° rotation.

4" Blade Handles with Sanitary Hood

These vandal-resistant handles are designed to meet the requirements of ADA standards and are available with or without "TI" temperature indicators. Delta Faucet offers handle variations to fit any of your applications.



- 6"-12" WIDESPREAD FAUCET**
23C674 – CER-TECK® Cartridge
- Cast brass bodies with brass pipe spout
 - Vandal-resistant 4" blade handles with sanitary hood
 - 1.0 gpm (3.8 L/min) laminar flow control in base of the smooth end spout



- 6"-12" WIDESPREAD FAUCET**
23C622-LS – CER-TECK Cartridge
- Cast brass bodies with brass pipe spout
 - Vandal-resistant 4" hooded blade handles
 - 1.5 gpm (5.7 L/min) laminar outlet with Agion® Antimicrobial finish
 - Maximum 120° rotation of spout (limited swing)



- 6"-12" WIDESPREAD FAUCET**
23T333 – TUF-TECK® Cartridge
23C333 – CER-TECK Cartridge
- Cast brass bodies and spout
 - Vandal-resistant 3" hooded lever handles
 - 1.5 gpm (5.7 L/min) vandal-resistant flow control aerator



- 4" CENTRESET FAUCET**
21T142 – TUF-TECK Cartridge
21C142 – CER-TECK Cartridge
- Cast brass body
 - Vandal-resistant 4" hooded blade handles
 - 1.5 gpm (5.7 L/min) standard flow control aerator



- 4" CENTRESET FAUCET**
2529LF-LGHGMHDF
- Solid brass fabricated body
 - Vandal-resistant wrist blade handles
 - 0.5 gpm (1.9 L/min) vandal-resistant spray outlet



- 4" CENTRESET FAUCET**
21T143 – TUF-TECK Cartridge
21C143 – CER-TECK Cartridge
- Cast brass body
 - Vandal-resistant 3" hooded lever handles
 - 1.5 gpm (5.7 L/min) standard flow control aerator



- 4" CENTRESET FAUCET**
2171LF-WBHDF
- Solid brass fabricated body
 - Vandal-resistant wrist blade handles
 - 1.5 gpm (5.7 L/min) vandal-resistant flow control aerator
 - Spout swings 360°



ADA Handle Options



- 3" Hooded Lever (Available with "TI" temperature indicator)



- 4" Hooded Blade (Available with "TI" temperature indicator)



- 6" Wrist with Sanitary Hood



- 4" Blade with Sanitary Hood (Available without "TI" temperature indicator)

LAVATORY FAUCETS – METERING

86T1193



Water-Efficient Outlet

This faucet comes standard with a 0.35 gpm @ 60 psi, 1.32 L/min @ 414 kPa vandal-resistant, flow control non-aerating outlet. Each handle is set not to exceed 0.25 gpm @ 60 psi, 0.95 L/min @ 414 kPa per activation.

Cast Brass Body

The one-piece solid cast brass construction of this faucet is designed for demanding environments where robust features are required.

Adjustable

Easily adjust the run time to match your water pressure.

ADA Tip Action Lever Handles

These tip action lever handles offer ease of use and meet ADA standards—a feature not typically offered in metering faucets.



SINGLE-HOLE FAUCET
87T105

- Cast brass body
- Vandal-resistant tip action lever handle
- Adjustable close time
- Tempered water supply by others
- 0.5 gpm (1.9 L/min) vandal-resistant spray outlet



SINGLE-HOLE FAUCET
87T104

- Cast brass body
- Vandal-resistant push style handle
- Adjustable close time
- Tempered water supply by others
- 0.5 gpm (1.9 L/min) vandal-resistant spray outlet



4" CENTRESET FAUCET
86T1193

- Cast brass body
- Vandal-resistant tip action lever handles
- Adjustable close time
- 0.35 gpm (1.32 L/min) vandal-resistant, flow control non-aerating outlet



FLUSH VALVES – ELECTRONIC + OPTIONS

Vandal Resistant

This all metal body with heavy-duty construction and chloramine-resistant diaphragm is loaded with features, including an external battery strength indicator and an easy valve lens replacement.

Adjustments Made Easy

The Delta® EZ Adjust® system allows flush volume adjustments, on field-adjustable models, to be made with a simple turn of an external adjustment screw. There is no need to turn off water supply lines or replace integral parts such as diaphragms or pistons when adjusting flow rates.

Smarter Water Usage

An optional dual flush mode delivers either a full flush or a 30% reduced flush, based on time and distance from the valve.

81T231BTA-MMO-BL



Manual Mechanical Override

A true manual mechanical override button on the -MMO models allows the unit to be flushed when power is unavailable.

Finish Options

Matte Black with Chrome finish now available on select models



EXPOSED SOLAR ELECTRONIC FLUSH VALVE FOR 1 1/2" TOP INLET WATER CLOSET
81T201SP-MMO – Solar

- Cast brass body and stop
- Chloramine-resistant diaphragm
- True mechanical manual override
- Scratch resistant lens window
- Vandal-resistant metal cover with top-mounted electronic sensor and solar module
- Factory set at 1.6 gal. (6 Litre) flush – field adjustable
- Batteries required and included
- Dual flush model available
- Also available in this series: WaterSense® listed 1.1 and 1.27 gpf (4.2 and 4.8 Lpf) fixed models



EXPOSED SOLAR ELECTRONIC FLUSH VALVE FOR 3/4" TOP INLET URINAL
81T231SP-MMO – Solar

- Cast brass body and stop
- Chloramine-resistant diaphragm
- True mechanical manual override
- Scratch resistant lens window
- Vandal-resistant metal cover with top-mounted electronic sensor and solar module
- Factory set at 0.5 gal. (1.9 Litre) flush – field adjustable
- Batteries required and included
- Also available in this series: WaterSense® listed 0.125 and 0.5 gpf (0.5 and 1.9 Lpf) fixed models



EXPOSED FLUSH VALVE WITH INTEGRAL SENSOR FOR 1 1/2" TOP INLET WATER CLOSET
81T201HWA – Hardwire
81T201BTA – Battery
81T201BTA-MMO – Battery Operated with Manual Mechanical Override

- Cast brass body and stop
- Chloramine-resistant diaphragm
- True mechanical manual override
- Replaceable lens window
- H₂Optics® Technology
- Factory set at 1.6 gal. (6 Litre) flush – field adjustable
- Chrome or Matte Black with Chrome finish
- Dual flush model available
- Also available in this series: WaterSense® listed 1.1 and 1.27 gpf (4.2 and 4.8 Lpf) fixed models





EXPOSED FLUSH VALVE WITH INTEGRAL SENSOR FOR 3/4" TOP INLET URINAL

81T231HWA – Hardwire
 81T231BTA – Battery
 81T231BTA-MMO – Battery Operated with Manual Mechanical Override

- Cast brass body and stop
- Chloramine-resistant diaphragm
- True mechanical manual override
- Replaceable lens window
- H₂Optics® Technology
- Factory set at 0.5 gal. (1.9 Litre) flush – field adjustable
- Chrome or Matte Black with Chrome finish
- Also available in this series: WaterSense® listed 0.125 and 0.5 gpf (0.5 and 1.9 Lpf) fixed models



CONCEALED FLUSH VALVE FOR 1 1/2" BACK INLET WALL HUNG-WATER CLOSET

1600T6103ATR and 1600T6103ARI – Hardwire

- Cast brass body and stop
- Electronic manual override button
- Vandal-resistant stainless steel cover
- Chloramine resistant diaphragm
- H₂Optics® Technology
- Factory set at 1.6 gal. (6 Litre) flush – field adjustable
- Also available in this series: WaterSense® listed 1.1 and 1.27 gpf (4.2 and 4.8 Lpf) fixed models



CONCEALED SOLENOID FLUSHING SYSTEM FOR BACK INLET WASHDOWN URINAL

1600T9001TR and 1600T9001RI – Hardwire

- Electronic manual override button
- Vandal-resistant stainless steel cover
- Slow closing solenoid valve
- H₂Optics® Technology
- Factory set at 0.5 gal. (1.9 Litre) flush – field adjustable



RETROFIT KIT TO UPGRADE EXPOSED DELTA® 1 1/2" TOP SPUD WATER CLOSET MANUAL FLUSH VALVES TO ELECTRONIC OPERATION

81T201HWA-20 – Hardwire
 81T201BTA-20 – Battery

- Cast brass body
- Complete valve less stop, cover tube and wall flange
- Chloramine-resistant diaphragm
- Metal manual override button
- Replaceable lens window
- H₂Optics® Technology
- Factory set at 1.6 gal. (6 Litre) flush – field adjustable



RETROFIT KIT TO UPGRADE EXPOSED DELTA MANUAL FLUSH VALVES TO ELECTRONIC OPERATION

81TWCBTRKA – Battery
 81TURBTRKA – Battery

- Converts manual exposed flush valves to electronic operation
- New diaphragm, seat and filter screen included
- Replaceable lens window
- H₂Optics® Technology
- To convert from battery to hardwire, order 060929A
- 81TWCBTRKA: Factory set at 1.6 gal. (6 Litre) flush – field adjustable
- 81TURBTRKA: Factory set at 0.5 gal. (1.9 Litre) flush – field adjustable



*Urinal model only



EXPOSED FLUSH VALVE WITH WALL-MOUNT SENSOR FOR 1 1/2" TOP INLET WATER CLOSET

81T201-WMSHWA – Hardwire

- Cast brass body and stop
- Chloramine-resistant diaphragm
- Electronic manual override button
- Vandal-resistant stainless steel cover
- H₂Optics® Technology
- Factory set at 1.6 gal. (6 Litre) flush – field adjustable



EXPOSED ELECTRONIC WASHDOWN URINAL FLUSH VALVE

DEMD-86505 – Battery

- Adjustable sensor range
- Remote control available, order 060967A
- Factory set at 0.5 gal. (1.9 Litre) flush – field adjustable



SIDE MOUNT RETROFIT KIT FOR DELTA EXPOSED MANUAL FLUSH VALVES

DEFM-100 – Battery

- For use on 81T TECK® exposed manual flush valves and 86T metering washdown urinal flush valves
- Can also be used on Sloan®, Crane® and some Zurn® models
- Courtesy manual flush button



Trim and Rough

The rough-ins and trims for our concealed electronic flush valves can be ordered and installed separately, which can help with project budgeting and reduce the chance of misplaced components.

Crane® is a registered trademark of Crane Plumbing Corp.

Sloan® is a registered trademark of Sloan Valve Company.

Zurn® is a registered trademark of Zurn Industries, LLC.

FLUSH VALVES – MANUAL

81T201



Flow Rate Options

A wide range of fixed and adjustable flow rate options available.

Delta® EZ Adjust® smart feature accommodates various flush volume requirements with a simple turn of an external adjustment screw and allows for Delta flush valves to have consistent performance on a broad assortment of fixtures, including fine tuning as is often required with “fussy” bowl designs.

EZ Adjust®

With the EZ Adjust® smart feature there is no need to turn off water supply lines or replace integral parts such as diaphragms or pistons when adjusting flow rates.

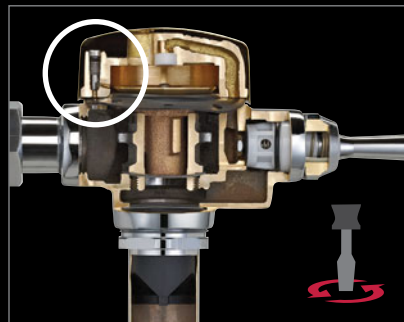

Vandal Resistant

This all-metal body with heavy-duty construction has a non-hold-open handle and chloramine-resistant diaphragm. Trap Seal Primer is also available.



FLUSH VALVE FOR 1 1/2" TOP INLET
WATER CLOSET
81T201

- Cast brass body and stop
- Chloramine-resistant diaphragm
- ADA vandal-resistant non-hold-open handle
- Factory set at 1.6 gal. (6 Litre) flush
- Also available in this series: 1.1 and 1.27 gpf (4.2 and 4.8 Lpf) fixed models



FLUSH VALVE FOR 3/4" TOP INLET FLUSHING
URINAL
81T231

- Cast brass body and stop
- Chloramine-resistant diaphragm
- ADA vandal-resistant non-hold-open handle
- Factory set at 0.5 gal. (1.9 Litre) flush at 60 psi
- Also available in this series: WaterSense® listed 0.125 and 0.5 gpf (0.5 and 1.9 Lpf) fixed models



FLUSH VALVE FOR 3/4" TOP INLET
WASHDOWN URINAL
86T505

- Cast brass body and stop
- ADA vandal-resistant handle
- Factory set at 0.5 gal. (1.9 Litre) flush – field adjustable



CONCEALED FLUSH VALVE FOR WALL-HUNG
1 1/2" BACK INLET WATER CLOSET
83T141

- ADA vandal-resistant non-hold open oscillating handle (can be installed anywhere within 6 metres (20') of flush valve)
- Chloramine resistant diaphragm
- Factory set at 1.6 gal. (6 Litre) flush – field adjustable



CONCEALED FLUSH VALVE FOR WALL-HUNG
3/4" BACK INLET URINAL
83T431

- ADA vandal-resistant non-hold-open oscillating handle (can be installed anywhere within 6 metres (20') for flush valve)
- Chloramine resistant diaphragm
- Factory set at 0.5 gal. (1.9 Litre) flush – field adjustable



HEALTHCARE



DESIGNED WITH HYGIENE IN MIND



While a doctor is scrubbing up for an early morning surgery, a nurse is caring for a patient, and a medical researcher is preparing the day's experiments. Each individual comes in contact with faucets in their own way, yet they share something in common: they cannot risk contamination.

Delta Faucet understands the unique needs of each situation and offers a range of commercial plumbing products designed with the application in mind. From hands-free specialty faucets that promote excellent hygiene to lab faucets and more, we deliver quality products you can count on—day after day.

HEALTHCARE – SURGEON SCRUB-UP

1500T4670



Seamless Brass Spout

Smooth end laminar outlet reduces maintenance and minimizes the risk of contaminant buildup.

Optional 3-Position Switch

Programmable periodic line rinse feature. High-temperature flush available with addition of optional 3-position switch.

Optional Mixing Valve

The deck-mount mixing valve features a washerless stainless steel rotating ball cartridge, integrated checks to prevent cross-flow and a 6" ADA lever blade handle.

Rigid/Swivel Gooseneck Spout

12" high gooseneck spout provides ample scrub-up space.



SURGEON SCRUB-UP FAUCET

1500T3370 – Hardwire

1501T3370 – Battery

- Single hole deckmount
- Cast brass main body with integral sensor and rigid spout
- 1.5 gpm (5.7 L/min) laminar flow control in base of smooth end spout
- Adjustable sensing range and timeout
- Selectable metering mode and periodic rinse features
- Surface mounted control housing



WALL-MOUNT FAUCET

1500T4670 – Hardwire

1501T4670 – Battery

- Cast brass main body with integral sensor and rigid spout
- 1.5 gpm (5.7 L/min) laminar flow control in base of smooth end spout
- Adjustable sensing range and timeout
- Selectable metering mode and periodic rinse features
- Surface mounted control housing



ABOVE DECK MIXING VALVE

24T3003

- Single-control mixing valve
- Vandal-resistant 6" elbow handle
- Stainless steel ball with adjustable handle limit stop
- For use with #0 control box

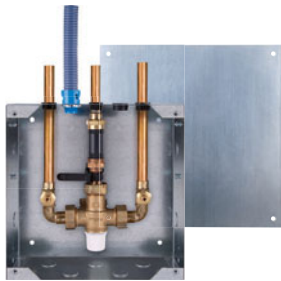

METAL CONTROL BOXES FOR RECESSED MOUNTING

ELAVT0001ARI – No Mixing Valve

ELAVT0008ARI – With Thermostatic Mixing Valve

- Save time with installation
- Pre-plumbed factory tested
- Available for 590T, 590TP, 591T, 591TP, 620TP, 621TP, 630TP, 631TP, and 1500T models



3-POSITION SWITCH

060651A

- Designed so healthcare facilities can continue to follow infectious control procedures.

SWITCH SETTINGS

- ON** – Solenoid goes into continuous run so water lines can be flushed with high temperature water.
 - Do not exceed 71° C (160° F) during flushing of lines as higher temperatures may damage sensor components.
- AUTO** – Faucet functions according to regular settings.
- OFF** – Solenoid is blocked from operating so cleaning staff can clean sink without faucet operating.

Batteries included with battery-operated models

Order battery back-up separately for hardwire models

Order transformer separately for hardwire models



SURGEON SCRUB-UP FAUCET

54T5432A

- Floor mount forged brass self-close double foot pedal valve
- Deck-mount rigid/swivel gooseneck spout
- Vandal-resistant 1.5 gpm (5.7 L/min) laminar with Agion® antimicrobial finish



SURGEON SCRUB-UP FAUCET

54T5332A

- Wall-mount forged brass self-close double foot pedal valve
- Deck-mount rigid/swivel gooseneck spout
- Vandal-resistant 1.5 gpm (5.7 L/min) laminar with Agion® antimicrobial finish



HEALTHCARE – LABORATORY

Services available:

- Air
- Cold Water
- Natural Gas
- Vacuum

Refer to www.specselect.com for
Valve/Service combination availability.





DECK-MOUNT MIXING FAUCET
W6760-9

- In-line vacuum breaker
- Nozzle outlet
- Cast brass body
- Vandal-resistant locking pins



DECK-MOUNT MIXING FAUCET
W6700-9

- In-line vacuum breaker
- Nozzle outlet
- Forged brass body



DECK-MOUNT SINGLE WATER FAUCET
W6600-10

- Angle vacuum breaker
- Nozzle outlet
- Forged brass body with vandal-resistant locking pin



DECK-MOUNT TURRET
W6210GAS

- Single ball valve hose cock
- Forged deck mount turret
- Indexed for natural gas service
- Supplied with check valve to prevent contamination of service lines and ball sealing surfaces
- Vandal-resistant locking pins



DECK-MOUNT TURRET
W6220GAS

- Two ball valve hose cocks at 90°
- Forged deck mount turret
- Indexed for natural gas service
- Supplied with check valve to prevent contamination of service lines and ball sealing surfaces
- Vandal-resistant locking pins



PURE WATER FAUCET
W6635DW – Distilled Water

- Self-close Celcon® valve
- Forged brass turret with vandal-resistant locking pins
- Indexed for distilled water
- Waterway lined with Tygon® tubing to prevent contact of water with metal components

Celcon® is a registered trademark of Ticona.
Tygon® is a registered trademark of Saint-Gobain Corporation.

SINK FAUCETS



STYLE AND COMFORT WITH ADA COMPLIANCE



Accessibility and ease of use are two key issues when designing an ADA-compliant facility. Manual faucets must be operable with just one hand, using only five pounds of force or less.

Whether you're selecting faucets for a universal designed facility or a general sink application, Delta® products provide the comfort of a familiar, accessible faucet brand. And with the range of two-handle, single-handle and wall-mount models available, you can find the faucets you need for your particular application.

SINK FAUCETS – SINGLE-HANDLE



ADA-Compliant Lever Handle

This faucet with an ADA-compliant lever handle allows you to carry a stylish design throughout your entire facility.

DIAMOND® Valve

Durability is provided by a diamond-coated ceramic disc.

Handle Limit Stop

Limits the movement of the handle into the hot water zone.



SINGLE-LEVER UTILITY FAUCET
711LF-HDF

- Solid fabricated brass body
- Vandal-resistant elbow handle
- Diamond-coated ceramic disc
- Adjustable handle limit stop
- 1.5 gpm (5.7 L/min) standard flow control aerator



SINGLE-LEVER PANTRY FAUCET
27T643 – TUF-TECK® Cartridge
27C643 – CER-TECK® Cartridge

- Cast brass body
- Vandal-resistant lever handle
- 1.5 gpm (5.7 L/min) standard flow control aerator



SINGLE-LEVER KITCHEN FAUCET
101LF-HDF

- Solid fabricated brass body
- Vandal-resistant elbow lever handle
- Diamond-coated ceramic disc
- Adjustable handle limit stop
- 1.5 gpm (5.7 L/min) standard flow control aerator



SINGLE-LEVER KITCHEN FAUCET
100LF-HDF

- Solid fabricated brass body
- 3-hole installation
- Vandal-resistant elbow lever handle
- Diamond-coated ceramic disc
- Adjustable handle limit stop
- 1.5 gpm (5.7 L/min) standard flow control aerator



SINGLE-LEVER KITCHEN FAUCET
400LF-HDF

- Solid fabricated brass body
- Side sprayer
- Vandal-resistant elbow lever handle
- Diamond-coated ceramic disc
- Adjustable handle limit stop
- 1.5 gpm (5.7 L/min) standard flow control aerator



SINK FAUCETS – TWO-HANDLE

26C3942



Seamless Brass Spout

Compared to traditional tubular spouts on the market, our solid brass spout boasts a .09" wall thickness which provides superior force resistance—making it difficult for would-be vandals to cause damage.

Water-Efficient Outlet

Available in four reduced flow options, ranging from 0.5 gpm @ 60 kPa (1.9 L/min @ 414 kPa) to 1.5 gpm @ 60 psi (5.7 L/min @ 414 kPa).

Rigid/Swivel Gooseneck Spout

Optional brass collar is supplied to accommodate rigid or swivel installation needs. Limited swing also available.

Cast Brass Body

The one-piece solid cast brass construction of this faucet is designed for demanding environments where robust features are required.



SINGLE SHANK MIXING FAUCET
25C3847 – CER-TECK® Cartridge

- Cast brass body with brass pipe gooseneck spout
- Vandal-resistant 2-1/2" balanced lever handles
- 1.5 gpm (5.7 L/min) standard flow control aerator



8" DECK MOUNT FAUCET
26C3942 – CER-TECK® Cartridge

- Cast brass body with brass pipe gooseneck spout
- Vandal-resistant 4" hooded blade handles
- 1.5 gpm (5.7 L/min) standard flow control aerator



8" BELOW DECK MOUNT FAUCET
27C2923 – CER-TECK® Cartridge

- Cast brass body with brass pipe gooseneck spout
- 1.5 gpm (5.7 L/min) vandal-resistant laminar outlet with Agion® antimicrobial finish
- Vandal-resistant 3" hooded lever handles



4" DECK MOUNT FAUCET
27T4844 – TUF-TECK® Cartridge
27C4844 – CER-TECK® Cartridge

- Cast brass body with brass pipe gooseneck spout
- Vandal-resistant 4" blade handles
- 1.5 gpm (5.7 L/min) standard flow control aerator



8" DECK MOUNT FAUCET
23C674 – CER-TECK® Cartridge

- Cast brass body with brass pipe gooseneck spout
- 6" to 12" (152mm to 305mm) adjustable centre
- Vandal-resistant 4" blade handles
- 1.0 gpm (3.8 L/min) laminar flow control in base of smooth end spout



8" CENTRE WALL-MOUNT PRE-RINSE FAUCET
55C1513 – CER-TECK® Cartridge

- Cast brass body with integral check stops
- Includes auto shut-off
- Vandal-resistant 3" hooded lever handles
- 1.05 gpm @ 60 psi (4 L/min @ 414 kPa)
- Spring loaded stainless steel hose



ADA Handle Options



- 3" Hooded Lever (Available with "TI" temperature indicator)



- 4" Hooded Blade (Available with "TI" temperature indicator)



- 6" Wrist with Sanitary Hood



- 4" Blade with Sanitary Hood (Available without "TI" temperature indicator)

SINK FAUCETS – WALL-MOUNT



Wall Brace

This sturdy wall brace reinforces the faucet to wall connection and helps to support heavy pails of water.

Integral Checks

Integral checks eliminate crossflow—preventing the hot water from traveling to the cold side and vice versa.

Body-Mounted Vacuum Breaker with Garden Hose End

The vacuum breaker prevents backflow of sink water into potable water systems. The standard hose end spout makes adding and removing garden hoses simple.



8" CENTRE WALL-MOUNT SERVICE
SINK FAUCET
28P4902LF

- 8" long tubular gooseneck swing spout
- Adjustable centres from 6.87" to 9.25"
- Vandal-resistant 4" hooded blade handles
- Cast brass body less integral stops
- 1.5 gpm (5.7L/min) vandal-resistant flow control aerator
- Brass stems with 1/4 turn stop



8" CENTRE WALL-MOUNT SERVICE
SINK FAUCET
28P4202LF

- 9 1/2" long swing spout
- Adjustable centres from 6.87" to 9.25"
- Vandal-resistant 4" hooded blade handles
- Cast brass body less integral stops
- 1.5 gpm (5.7L/min) vandal-resistant flow control aerator
- Brass stems with 1/4 turn stop



8" CENTRE WALL-MOUNT SERVICE
SINK FAUCET
28P4402LF

- 8" long swing spout
- Adjustable centres from 6.87" to 9.25"
- Vandal-resistant 4" hooded blade handles
- Cast brass body less integral stops
- 1.5 gpm (5.7L/min) vandal-resistant flow control aerator
- Brass stems with 1/4 turn stop



8" CENTRE WALL-MOUNT SERVICE
SINK FAUCET
28T2383 – TUF-TECK® Cartridge
28C2383 – CER-TECK® Cartridge

- Cast brass body with integral check stops
- Adjustable top/bottom brace
- Body-mounted angle vacuum breaker with garden hose end
- Vandal-resistant 3" hooded lever handles



8" CENTRE WALL-MOUNT SERVICE
SINK FAUCET
28T9

- Cast brass body with integral stops
- ASSE-approved integral vacuum breaker with garden hose end
- Metal cross handles
- Compression cartridge
- Rough chrome-plated



8" CENTRE WALL-MOUNT SERVICE
SINK FAUCET
28C9LH

- Cast brass body with integral stops
- Inline vacuum breaker with garden hose end
- 4" colour indexed metal lever handles
- 1/4 turn ceramic structures
- Rough chrome-plated



8" CENTRE WALL-MOUNT SERVICE
SINK FAUCET

- 28T8073 – TUF-TECK® Cartridge
28C8073 – CER-TECK® Cartridge
- Cast brass body with integral check stops
 - Spout end vacuum breaker with garden hose end
 - Includes 48" hose and stainless steel hanger
 - Rough chrome-plated
 - Vandal-resistant 3" hooded lever handles



8" CENTRE WALL-MOUNT
SINK FAUCET
28C4434 – CER-TECK® Cartridge

- Cast brass body less integral stops
- 11" (279 mm) swing spout
- Vandal-resistant 4" blade handles with sanitary hood
- 1.5 gpm (5.7 L/min) vandal-resistant flow control aerator



8" CENTRE WALL-MOUNT
SINK FAUCET
28C6933 – CER-TECK® Cartridge

- Cast brass body with integral check stops
- Vandal-resistant 3" hooded lever handles
- 1.5 gpm (5.7 L/min) vandal-resistant flow control aerator



ADA GRAB BARS

**Meeting Requirements.
Exceeding Expectations.**

Answering a growing need in assisted living, medical, multi-family and aging-in-place environments, Delta Faucet offers a variety of ADA-compliant grab bars. They're available in a wide range of sizes to meet your project requirements, and a full spectrum of designs and finishes.

41818





ADA GRAB BAR

40118-SS – 18" 40136-SS – 36"
 40124-SS – 24" 40142-SS – 42"
 40130-SS – 30" 40148-SS – 48"

- 1 ½" diameter
- Supports up to 500 pounds when properly installed
- Concealed mounting
- Mounting hardware included

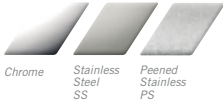

Chrome Stainless Steel SS Peened Stainless PS
 AVAILABLE ON SELECT MODELS ONLY.



ADA GRAB BAR

41124-SS – 24" 41136-SS – 36"
 41130-SS – 30" 41142-SS – 42"

- 1 ¼" diameter
- Supports up to 500 pounds when properly installed
- Concealed mounting
- Mounting hardware included

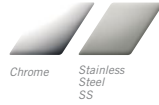

Chrome Stainless Steel SS
 AVAILABLE ON SELECT MODELS ONLY.



ADA GRAB BAR

41218 – 18"

- 1 ¼" diameter
- Supports up to 500 pounds when properly installed
- Concealed mounting
- Mounting hardware included



Chrome
 AVAILABLE ON SELECT MODELS ONLY.



TRADITIONAL DECORATIVE ADA GRAB BAR

41612 – 12" 41636 – 36"
 41618 – 18" 41642 – 42"
 41624 – 24"

- 1 ¼" diameter
- Supports up to 500 pounds when properly installed
- Concealed mounting
- Mounting hardware included



Chrome Brilliance® Stainless SS Venetian Bronze® RB
 AVAILABLE ON SELECT MODELS ONLY.



TRANSITIONAL DECORATIVE ADA GRAB BAR

41712 – 12" 41736 – 36"
 41718 – 18" 41742 – 42"
 41724 – 24"

- 1 ¼" diameter
- Supports up to 500 pounds when properly installed
- Concealed mounting
- Mounting hardware included

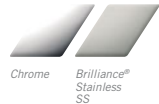

Chrome Brilliance® Stainless SS
 AVAILABLE ON SELECT MODELS ONLY.



CONTEMPORARY DECORATIVE ADA GRAB BAR

41812 – 12" 41836 – 36"
 41818 – 18" 41842 – 42"
 41824 – 24"

- 1 ¼" diameter
- Supports up to 500 pounds when properly installed
- Concealed mounting
- Mounting hardware included



Chrome Brilliance® Stainless SS Matte Black BL
 AVAILABLE ON SELECT MODELS ONLY.



ANGULAR MODERN DECORATIVE ADA GRAB BAR

41912 – 12" 41936 – 36"
 41918 – 18" 41942 – 42"
 41924 – 24"

- 1 ¼" width
- Supports up to 500 pounds when properly installed
- Concealed mounting
- Mounting hardware included



Chrome Brilliance® Stainless SS Venetian Bronze® RB Polished Nickel PN
 AVAILABLE ON SELECT MODELS ONLY.



TUB & SHOWER

MultiChoice® Universal Rough-in

One Rough. Unlimited Possibilities.

With either the pressure-balanced or thermostatic cartridge, you only need one rough from Delta Faucet—the MultiChoice® Universal Rough-in. This single rough works with any Delta® valve cartridge plus any Delta® faucet trim package for unlimited style flexibility.

Eliminates the Wrong Valve in the Wall

Now you don't have to worry about ordering and installing the wrong valve, no matter which Delta® tub/shower your customer chooses.

Flexibility Throughout the Building Process

Changes to the shower can be made at any time in the building process without altering the behind-the-wall plumbing.

Saves Time and Hassle

Streamlines the whole plumbing and product installation process.

Ability To Mount
Back-to-Back

Multiple Connection
Options Available

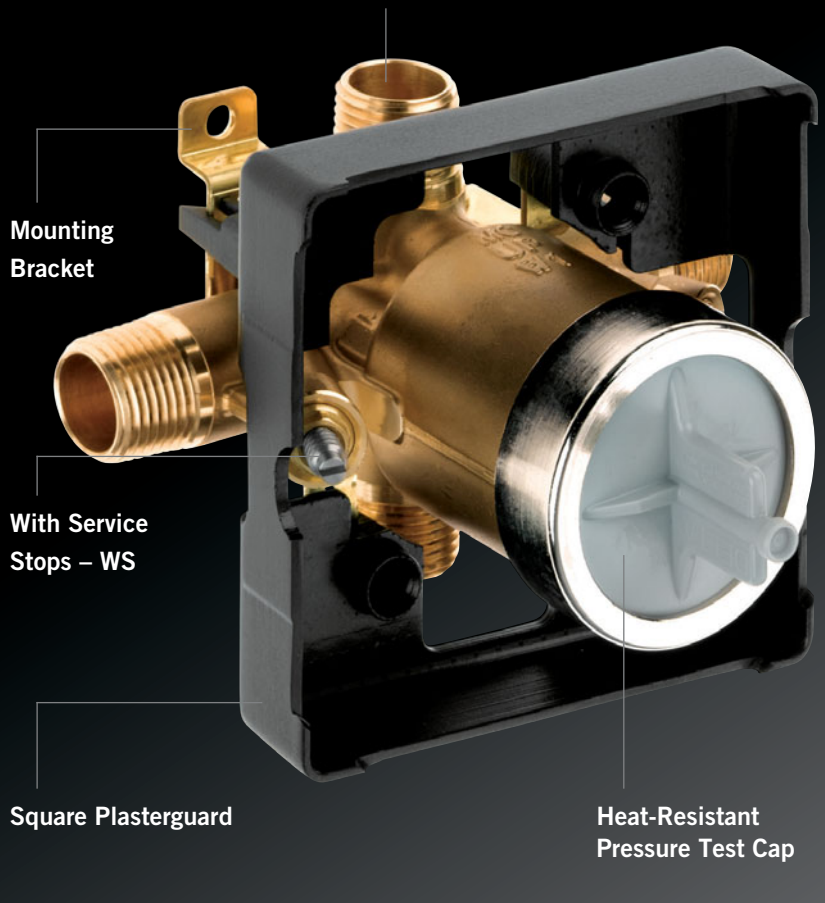

Single-Function Pressure-Balanced Valve Cartridge

Functions with a single control for temperature only.



Dual-Function Thermostatic Valve Cartridge

Keeps water temperature consistent by actually measuring and monitoring the temperature of the water and automatically adjusting the water mix to maintain a more precise water temperature.



TUB AND SHOWER TRIM ONLY
T13H283

- H₂Okinetic® Technology shower head, 1.5 gpm (5.7 L/min)
- Vandal-resistant lever blade handle
- Escutcheon with non-removable red/blue marking
- Requires separate order of R10000-UNWS MultiChoice® valve body rough-in
- Single function pressure balance cartridge



*Tub spout diverter not ADA



SHOWER TRIM ONLY
T13H123

- Touch-Clean® 3-setting shower head, 1.75 gpm (6.6 L/min)
- Vandal-resistant lever blade handle
- Escutcheon with non-removable red/blue marking
- Requires separate order of R10000-UNWS MultiChoice® valve body rough-in
- Single function pressure balance cartridge



TUB AND SHOWER TRIM ONLY
T13H233

- Vandal-resistant lever blade handle
- Escutcheon with non-removable red/blue marking
- Touch-Clean® shower head, 1.5 gpm (5.7 L/min)
- Requires separate order of R10000-UNWS MultiChoice® valve body rough-in
- Single function pressure balance cartridge



*Tub spout diverter not ADA



SHOWER TRIM ONLY
T17TH125 R10000-UNWS

- TempAssure® thermostatic shower cartridge
- Non-removable red/blue indicators
- Touch-Clean® 3-setting shower head, 1.75 gpm (6.6 L/min)
- Vandal-resistant volume control handle with temperature adjustment
- Requires separate order of R10000-UNWS MultiChoice® valve body rough-in



SHOWER TRIM ONLY
T13H332

- Touch-Clean® shower head, 1.5 gpm (5.7 L/min)
- Hand shower with 24" stainless steel slide bar with ADA adjustable slide and 70" vinyl hose
- Vandal-resistant lever handle
- Escutcheon with non-removable red/blue marking
- Requires separate order of R10700-UNWS MultiChoice® valve body and diverter rough-in



SHOWER TRIM ONLY
T17TH155

- TempAssure® thermostatic shower cartridge
- 24" stainless steel slide bar with ADA adjustable slide
- Non-removable red/blue indicators
- Vandal-resistant volume control handle with temperature adjustment
- 2.5 gpm (9.5 L/min) hand shower
- Requires separate order of R10000-UNWS MultiChoice® valve body rough-in



TUB AND SHOWER TRIM ONLY
T13491

- Touch-Clean® shower head, 1.75 gpm (6.6 L/min)
- Red/blue indicators
- Vandal-resistant lever handle
- Requires separate order of R10000-UNWS MultiChoice® valve body rough-in



*Tub spout diverter not ADA



TUB AND SHOWER TRIM ONLY
T13691

- MultiChoice® Universal pressure balance tub/shower
- Integral push button diverter
- Touch-Clean® shower head, 1.75 gpm (6.6 L/min)
- Vandal-resistant lever handle
- Non-removable red/blue indicator
- Requires separate order of R10300-UNWS MultiChoice® valve body rough-in with push button diverter



*Diverter not ADA



PUSH BUTTON ELECTRONIC SHOWER
860T177 – Hardwire
861T177 – Battery

- Field adjustable shower times
- Vandal-resistant forged brass shower head, 1.5 gpm (5.7 L/min)
- Hardwire version requires separate transformer by others



SHOWER HEADS AND DRAINAGE



3-SETTING TOUCH-CLEAN® SHOWER HEAD
RP43381

- 1.75 gpm (6.6 L/min)



TOUCH-CLEAN® SHOWER HEAD
RP38357

- 1.75 gpm (6.6 L/min)



TOUCH-CLEAN® SHOWER HEAD
52672-15-BG

- 1.5 gpm (5.7 L/min)



H₂OKINETIC® SHOWER HEAD
RP46384

- 1.5 gpm (5.7 L/min)



TOUCH-CLEAN® HAND SHOWER
59462-WHB15-BG

- 1.5 gpm (5.7 L/min), 1.75 gpm (6.6 L/min) and 2.5 gpm (9.5 L/min) models available
- Pause feature



30° VANDAL-RESISTANT FORGED WALL-MOUNT SHOWER HEAD
063196A

- 1.5 gpm (5.7 L/min) and 2.0 gpm (7.6 L/min) models available



30° VANDAL-RESISTANT CAST WALL-MOUNT SHOWER HEAD
061011A

- 1.5 gpm (5.7 L/min), 1.75 gpm (6.6 L/min), 2.0 gpm (7.6 L/min) and 2.5 gpm (9.5 L/min) models available

All shower heads are at 80 psi (552 kPa).

*1.5 and 1.75 gpm (5.7 and 6.6 L/min) models only.

RP46384



CAST LAVATORY WASTE
33T290-1

- Offset open grid strainer less overflow holes
- With overflow model available (33T290)
- 5" (127 mm) fixed centres offset



HOODED OPEN GRID STRAINER
33T290-1DC

- Prevents direct flow of water into drain
- Hood is removable for cleaning
- Less overflow holes
- 5" (127 mm) fixed centres offset



LAVATORY SUPPLIES
47P2312SD

- 3/8" IP inlet lavatory supplies
- Brass supply nipples
- Lockshield screwdriver slot angle stops
- S/S wall flanges



WATER CLOSET SUPPLY
47P1316SD

- 3/8" IP inlet water closet supply
- Brass supply nipple
- Lockshield screwdriver slot angle stops
- 3/8" OD x 12" flexible riser
- S/S wall flange



CAST LAVATORY WASTE
33T260-1

- Open grid strainer less overflow holes
- With overflow model available (33T260)



HOODED OPEN GRID STRAINER
33T260-1DC

- Prevents direct flow of water into drain
- Hood is removable for cleaning
- Less overflow holes



CAST P TRAP
33T311 - 1 1/4"
33T360 - 1 1/2"

- With cleanout
- Also available less cleanout

Hooded Grid Drains

Our patented hooded drain cover forces the water to curl around the hood before entering the drain, rather than flowing directly into it. This reduces the chance of water and other drain contents splashing back out.

Direct flow of water curls around the hood and substantially aids in the reduction of backslash

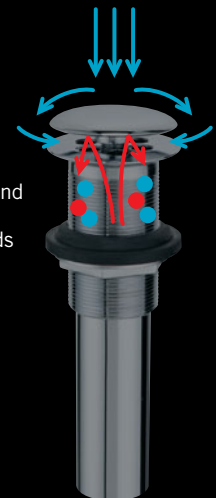

WEB

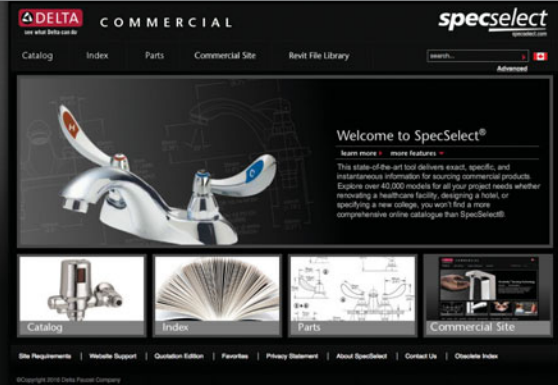
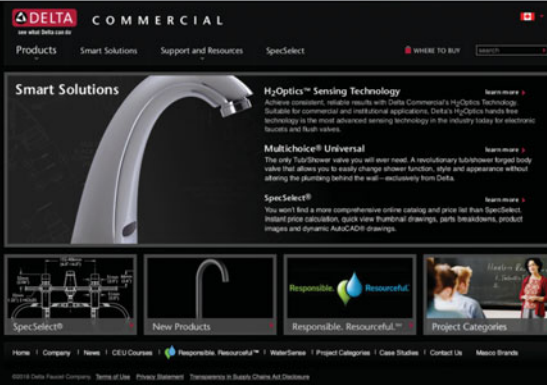

Learn more about
Delta® commercial products
and technologies at:

deltacommercialfaucets.ca

The Delta Faucet Commercial website features our most popular products and showcases Delta® product innovations and technologies. Here, you can search for products by function, project type or model number, learn about our sustainability initiatives, download product literature and search for distributors.

Source Delta® commercial
products at:

specselect.com

At SpecSelect.com, you can explore models for all your project needs, get pricing information, download product specifications and installation guides or access AutoCAD® and Revit® files. Whether renovating a healthcare facility, designing a hotel, or specifying a new college, you won't find a more comprehensive online resource for Delta® commercial products than SpecSelect.com.

Customer Service: **1.800.567.3300**



Delta Faucet is committed to sustainability and providing smart water delivery solutions that maximize water savings without sacrificing comfort and convenience. Our commitment to sustainability extends to waste reduction and the preservation of natural resources and the environment. That's why we choose to print on Forest Stewardship Council® (FSC®) certified paper.



see what Delta can do™

A MASCO COMPANY

Masco Canada Limited
350 South Edgeware Road
St. Thomas, Ontario N5P 4L1

deltacommercialfaucets.ca

Customer Service: 1.800.567.3300

©2019 Masco Canada Limited
All rights reserved.



EFFECTIVE
February 2019
MKT-18-138E