

Wallmount Service Sink Faucets Rigid Spout

TECK®

DELTA
COMMERCIAL

Specification: (example)

- **HEAVY-DUTY CAST BRASS** two handle wallmount service sink faucet
 - 203mm (8") centers, polished chrome plated finish
 - Integral check stops
 - **HEAVY DUTY** 1/2" IPS **BRASS PIPE** rigid pail hook spout
 - ADA compliant color indexed metal lever or blade handles with vandal resistant screws
- and ... with ... (add **CER-TECK™** 1/4 turn ceramic structures or **TUF-TECK™** compression structures)
- with ... (add spout/brace required)
 - with ... (add outlet/VB required)
 - with ... (add handle required)
 - with ... adjustable centers
- (add Suffix **AC** if required – See Back Page)

28C2384
28T2384



28C2383
28T2383



Engineer/Architect Approval













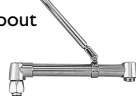

Model Specified:

Approval:

Date:

DESCRIPTION		PRODUCT NO.		
Two Handle Wallmount With Integral Check Stops	CER-TECK™	28C2		
	TUF-TECK™	28T2		



SPOUT/BRACE		OUTLET/VB		HANDLE	
0	140mm (5 1/2") Spout, Plain 	0		0	
1		1	Body Mounted Double-Check Vacuum Breaker, Hose Thread Outlet (1) 	1	
2	267mm (10 1/2") Spout, Plain 	2	Vandal Resistant 1.5 USGPM (5.7 L/min.) Laminar w/Antimicrobial By AgION™ 	2	102mm (4") Hooded Blade Handles 
3	267mm (10 1/2") Spout with Adjustable Top/Bottom Brace 	3	Vandal Resistant 1.5 USGPM (5.7 L/min.) Flow Control Aerator 	3	76mm (3") Lever Blade Handles 
4		4	Standard 1.5 USGPM (5.7 L/min.) Flow Control Aerator 	4	102mm (4") Blade Handles, Sanitary Hoods 
5		5	Hose Thread Outlet 	5	152mm (6") Wrist Handles, Sanitary Hoods 
6		6	Spout End Vacuum Breaker, Hose Thread Outlet 	6	
7		7	Same as No. 6 above with 1219mm (48") Hose and Stainless Steel Hanger	7	
8		8	Body Mounted Angle Vacuum Breaker, Hose Thread Outlet 	8	
9	406mm (16 1/2") Spout with Bottom Fork Brace (2) 	9	Same as No. 8 above with 1219mm (48") Hose and Stainless Steel Hanger	9	

(1) Recommended For Applications With A Shut-Off Valve After Spout Outlet.

(2) AC Suffix not available with #9 Spout/Brace Option.

Refer to www.specselectonline.com for individual models.

Flowrates are at 60 PSI.

Note: Use this page front and back as a product submittal sheet.

Delta reserves the right (1) to make changes in specifications and materials, and (2) to change or discontinue models, both without notice or obligation. Dimensions are for reference only. See current full-line price book or www.specselectonline.com for finish options and product availability.

Approvals:

- CSA certified
 - Complies to ASME A112.18.1
 - Lever Blade Handle No.'s 2, 3, 4 and 5, ADA Compliant and meet Handicapped Accessibility Standard ASME A117.1 of less than 5 lbs. operating force.
 - **OUTLET/VACUUM BREAKERS:**
 - No. 1 Certified under CSA Standard B64.8 and meets ASSE 1035
 - No. 6 Certified under ASSE 1011 and CSA Standard B64.2
 - No. 8 Certified under ASSE 1001 and CSA Standard B64.1.1
 - IAPMO listed
- (Contact Delta Representative for State and/or Local Approvals.)

FLOWRATE vs PRESSURE

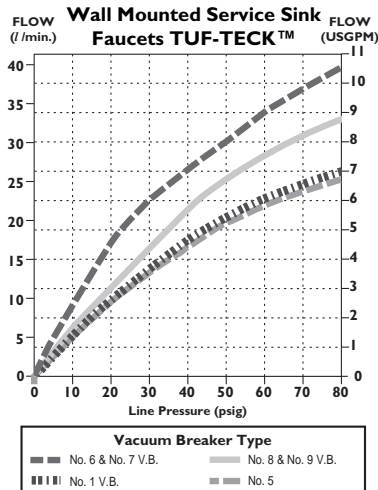
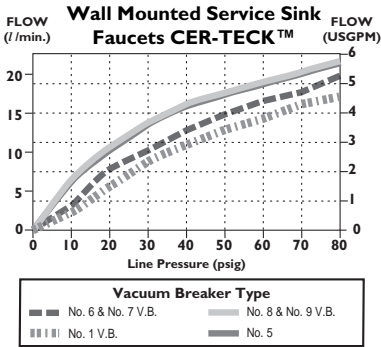
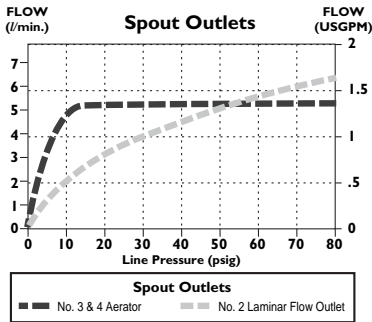

WALLMOUNT FAUCET

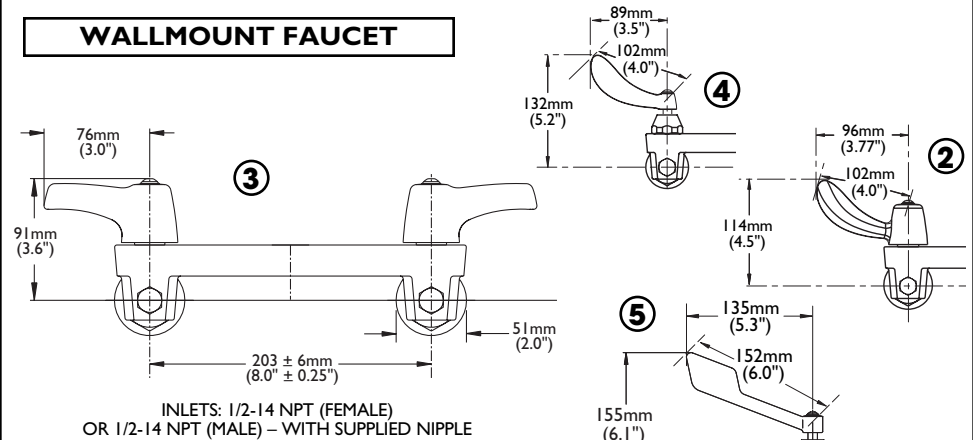

SPOUT/BRACE

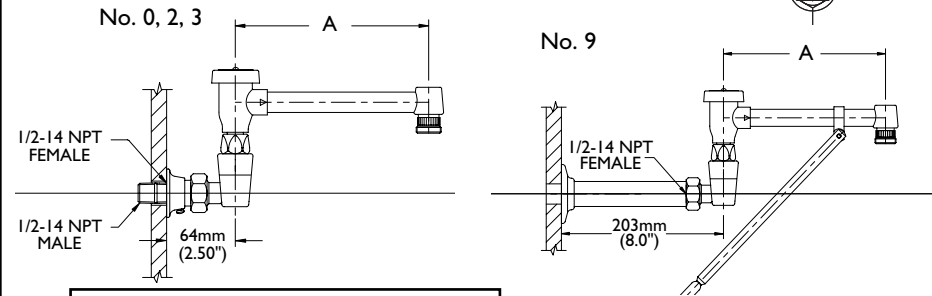

ADJUSTABLE CENTERS

□ Add Suffix "AC" to Product Number

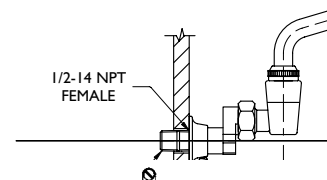
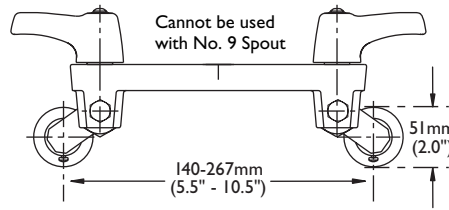

TOP BRACE

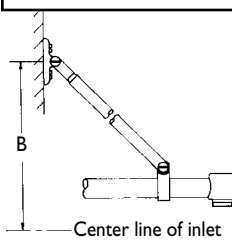

BOTTOM BRACE

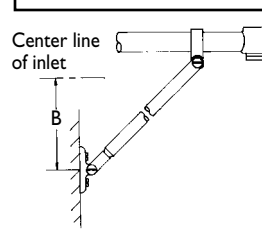

BRACES

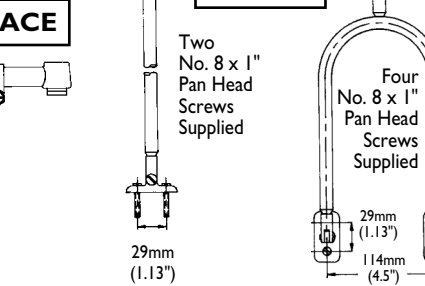

RIGID SPOUT ASSEMBLIES

SPOUT DIMENSIONS	Outlet/VB - "A"					
	#1	#2,3,4,5,6,7	#8 & 9			
	mm	in.	mm	in.	mm	in.
Spout/Brace #0 less -AC	104	4.1	81	3.2	86	3.4
Spout/Brace #2 less -AC	211	8.3	203	8.0	208	8.2
Spout/Brace #3 less -AC	211	8.3	203	8.0	208	8.2
Spout/Brace #9 less -AC	211	8.3	203	8.0	208	8.2
Spout/Brace #0 with -AC	104	4.1	81	3.2	86	3.4
Spout/Brace #2 with -AC	211	8.3	203	8.0	208	8.2
Spout/Brace #3 with -AC	211	8.3	203	8.0	208	8.2
Spout/Brace #9 with -AC	#9 spout/brace not available with - AC suffix					

INLETS - 1/2" FIP/MIP on Spouts # 0, 2, 3
 INLETS - 1/2" FIP on Spout # 9

Note: Measurements may vary ± 6mm (0.25")

Brace Rough-in dimensions based on #8 and 9 Outlet/VB