

uponor

PRE-INSULATED
PIPE SYSTEMS

DESIGN AND
INSTALLATION MANUAL

Pre-insulated Pipe System at its Best —
Versatile, Sustainable and Flexible

**Uponor Pre-insulated Pipe Systems
Design and Installation Manual**

Published by Uponor, Inc.
5925 148th Street West
Apple Valley, MN 55124 USA
Phone: (800) 321-4739
Fax: (952) 891-2008

Uponor, Ltd.
2000 Argentia Rd., Plaza 1, Ste. 200
Mississauga, ON L5N 1W1 CANADA
Tel: (888) 994-7726
Fax: (800) 638-9517

www.uponor-usa.com
www.uponor.ca

© 2009 Uponor
All Rights Reserved.

First Edition
First Printing, July 2009
Printed in the United States of America

This design and installation manual is published for heating contractors, engineers, architects, designers, building officials and other individuals interested in pre-insulated distribution systems. This manual describes Uponor Pre-insulated Pipe systems featuring the Ecoflex® product line.

Uponor has used reasonable efforts in collecting, preparing and providing quality information and material in this document. However, system enhancements may result in modification of features or specifications without notice.

All information in this guide is accurate and dependable,

including drawings, pictures and graphical presentations, representing current knowledge. As we continue to update and add new features to our line of pre-insulated pipe technology, Uponor does not guarantee the accuracy or completeness of the information contained in this document. Uponor is not liable for installation practices that deviate from this installation guide or are not acceptable practices within the mechanical trades.

To ensure proper system specification, this manual includes both the installation guide and product design manual for Uponor Pre-insulated Pipe systems.

Uponor Pre-insulated Pipe systems are versatile and applicable for a variety of uses. Please direct any questions concerning the suitability of an application or a specific design to Uponor.

Liability for Uponor Pre-insulated Pipe (Ecoflex) products is stated in our written warranty available upon request from Uponor. The user of the product must study the suitability of the product to the designed purpose. Uponor reserves the right to change the product or accessories without prior written notification. For the most current technical information, go to the Uponor website at www.uponor-usa.com or www.uponor.ca.

The logo for Uponor, featuring the word "Uponor" in a bold, blue, sans-serif font.

Table of Contents

| | |
|---|------------|
| Glossary of Terms | 4-6 |
| Section 1: Uponor Pre-insulated Pipe Systems Overview..... | 7 |
| Features and Benefits..... | 7 |
| Product Line..... | 7 |
| Section 2: Products and Hardware | 9 |
| Pre-insulated Pipe Construction | 9 |
| Jacket | 9 |
| Service Pipes..... | 9 |
| Ecoflex Thermal Single and Thermal Twin | 10 |
| Ecoflex Potable HDPE | 11 |
| Product Accessories | 12 |
| Rubber End Caps..... | 12 |
| ProPEX® Fittings | 12 |
| EP Fittings..... | 12 |
| WIPEX™ Fittings | 13 |
| Connection Vaults | 13 |
| Shrink Sleeves for Connection Vaults..... | 13 |
| Straight Insulation Kits..... | 13 |
| Tee Insulation Kits..... | 13 |
| 90-degree Elbow Insulation Kits | 13 |
| H-insulation Kits | 13 |
| Ecoflex Reducer Bushings | 14 |
| Wall Sleeve with Heat Shrink Seal Kit..... | 14 |
| Wall Sleeve | 14 |
| Compression Wall Seal..... | 14 |
| Section 3: Design Considerations..... | 15 |
| Traditional Piping versus Ecoflex Design..... | 15 |
| Pipe Flexibility..... | 15 |
| Longer Pipe Length..... | 16 |
| Design Layout Options..... | 16 |
| Direct-run Piping..... | 16 |
| Building-to-Building (Daisy Chain) Piping | 16 |

| | |
|--|-----------|
| Pipe Connection Considerations..... | 16 |
| Insulation Kit Piping..... | 16 |
| Connection Vault Piping..... | 17 |
| Pipe Routing Considerations..... | 18 |
| Obstacle Avoidance..... | 18 |
| Linear Expansion and Contraction..... | 18 |
| Reduction in Required Fittings..... | 18 |
| Energy Savings by Design..... | 18 |
| Pipe Heat Loss..... | 19 |
| Selecting System Components..... | 19 |
| Rubber End Caps..... | 19 |
| Adapter Fittings..... | 19 |
| Fusion and Welding Connectors..... | 19 |
| Fixing the Pipe..... | 19 |
| Wall Penetrations..... | 20 |
| Piping Layout..... | 20 |
| Items to Consider..... | 20 |
| Installation at Buildings..... | 21 |
| Slab-On-Grade Installation..... | 21 |
| Dry Well..... | 22 |
| Anchoring..... | 22 |
| Piping Selection..... | 22-23 |
| Estimating Labor..... | 23-24 |
| Section 4: Installation Guide..... | 25 |
| Handling and Storing Pipe Coils..... | 25 |
| Delivery Contents..... | 25 |
| Unloading..... | 25 |
| Storage..... | 25 |
| Pipe Installation..... | 26 |
| Uncoiling the Pipe..... | 26 |
| Uncoiling Small Dimension and Short Lengths..... | 26 |
| Uncoiling Large Dimension and Long Coils..... | 26 |
| Inspect Pipe for Damage..... | 26 |
| Pipe Bending Radius..... | 26 |
| Installation in Cold Climates..... | 26 |

| | |
|--|--------------|
| Trench Preparation | 27 |
| Wall or Ceiling Installation | 28 |
| Ecoflex Pipe Preparation | 28 |
| Tools Required..... | 28 |
| Installing the Ecoflex EPDM Rubber End Cap | 29 |
| Tools Required..... | 29 |
| Instructions..... | 29-31 |
| Installing WIPEX Fittings | 31 |
| Tools and Parts Required..... | 31 |
| Instructions..... | 32-34 |
| Installing the Connection Vault | 34 |
| Tools Required..... | 34 |
| Instructions..... | 34-36 |
| Installing with Insulation Kits | 36 |
| Tools Required..... | 36 |
| Instructions..... | 37-39 |
| Compression Wall Seal Installation Methods | 40 |
| Tools Required..... | 40 |
| Wall Sleeve Installation Example..... | 40 |
| Core Holes in Water-impermeable Concrete | 40 |
| Wall Sleeve Installation..... | 41 |
| Installing the Wall Seal into Core Hole or Wall Sleeve | 42 |
| Jacket Repair – Procedures for the Poly Tape Method..... | 43 |
| Tools Required..... | 43 |
| Section 5: Appendix A — Pressure Loss Charts | 45-48 |
| Section 6: Appendix B — Energy/Heat Loss Chart..... | 49-51 |
| Section 7: Appendix C — Detailed Drawings..... | 53-56 |

Glossary of Terms

To understand the design and installation of pre-insulated plastic piping systems, it is important to become familiar with the terminology used in this manual. Some of the definitions found in this chapter are unique to pre-insulated plastic piping systems, and some may be applicable only to Ecoflex applications. Following is a list of terms used in this manual.

Ambient Temperature — Temperature of the surrounding environment.

BAR — Metric equivalent of 14.5038 psi.

BTU (British Thermal Unit) — A unit of measure equal to the amount of energy necessary to raise the temperature of one pound of water one degree Fahrenheit

- **BTU/h** — The amount of BTU expended per hour
- **BTU/h/ft²** — The amount of BTU expended per hour per square foot of panel. BTU/h/ft² is derived by dividing the BTU/h by the amount of available square footage in the room to be heated.

Closed Loop — Any piping arrangement in a circulating system that protects the circulating medium (water) against exposure to atmospheric pressure.

Closed System — Any closed-loop hydronic piping system that prevents atmospheric oxygen from entering the system to a degree, effectively protecting components from excessive oxidative corrosion (See DIN 4726 in this glossary.)

Coefficient of Expansion — The fractional change in length for a rise in temperature of 1°F at a given constant pressure. The coefficient of expansion for PEX is:

- 78×10^{-6} in/in/°F (at 68°F)
- 78×10^{-6} in/in/°F (at 212°F)

Conduction — A process of heat transfer whereby heat moves through a material or between two materials that are in direct contact with each other.

Convection — Transfer of heat by movement of a liquid or a gas

- Natural convection is a result of movement caused by changes in density as temperature changes within a fluid medium, such as a liquid or a gas.
- Forced convection is the result of mechanical force moving a fluid or gas.

Creep — Creep occurs in plastic pipe as a response

to an applied long-term constant stress, such as hydrostatic or thermal expansion. The plastic material responds to stress by gradually yielding to a point and at a rate specific to the material. For details about the effects of creep on a piping material, refer to the time-to-failure tensile test as specified in ASTM D2990.

Crosslinking — A chemical process that changes the molecular structure of a polymer material by linking otherwise independent hydrocarbon chains. Crosslinking creates a three-dimensional network of hydrocarbons. The final product is incapable of being melted and is insoluble.

DIN — DIN is an abbreviation for the German Institute of Standards (Deutsches Institut für Normung).

DIN 4726 — An internationally recognized standard that prescribes, among other things, the maximum rate of oxygen diffusion allowed for non-metallic pipes used in closed-loop hydronic heating systems.

Differential Temperature (Δt) — The difference in temperature between two opposing masses used to describe the potential that exists for heat transfer.

Emission — A measure of the propensity of a surface to radiate heat energy to its surroundings in the form of long-wave radiation.

Energy Loss — The transfer of heat (or cold) from a contained space to the atmosphere surrounding it.

Engel Method — This is a peroxide-based method of manufacturing crosslinked polyethylene (PEX) piping. Engel-method PEX is crosslinked during the extrusion process while the raw polyethylene is above its crystal melting temperature, creating an even, consistent three-dimensional network of joined hydrocarbons.

EPDM — An abbreviation for Ethylene Propylene Diene Monomer (EPDM) — it has excellent temperature and chemical resistance, and is widely used for gasket and seal material.

EVOH — Enhanced oxygen barrier performance from modification of ethylene vinyl alcohol copolymers.

Extrusion — A method used for the continuous formation of tubing from polymer materials.

Feet of Head — Piping system pressures and pressure/friction losses are often referred to in "feet of head" or "foot head." Feet of head equals the amount of pressure that would result from a column of water one foot high. For example, a 20-foot

head is the pressure at the bottom of a 20-foot column of water.

HDPE — An abbreviation for high-density polyethylene, having a standard density of 0.941 g/cm³ (gram per cubic centimeter) or greater.

Head Pressure Loss — The pressure available at the outlet side of a pump or inlet side of a flow-conducting system. It is expressed in feet of head. Feet of head is the height of a column of water that is supported by a pump against standard atmospheric pressure.

Heating Load — The amount of energy (in BTU/h) required for space heating.

K Factor (thermal conductivity) — The time rate of steady-state heat flow through a unit area of homogeneous material induced by a unit temperature gradient in a direction perpendicular to that unit area:

- In inch-pound units, BTU x in./h x ft² °F
- In SI units, W/m x K

LDPE — An abbreviation for low-density polyethylene having a density of 0.910 to 0.925 g/cm³ (gram per cubic centimeter).

Linear Expansion (thermal) — Refers to the physical material characteristic of a body, which causes it to expand in the presence of heat. It is known as heat expansion. Linear expansion creates a force within the product, which, if held back by huge compressive strengths such as concrete, will transmit itself as an internal stress. Unlike other piping products, PEX is highly resistant to stresses caused by linear expansion.

MDPE — An abbreviation for medium-density polyethylene, having a density of 0.926 to 0.940 g/cm³ (gram per cubic centimeter).

Modulus of Elasticity — Also referred to as Young's Modulus, it is the ratio of normal stress to corresponding strain. A material with a low modulus of elasticity is more flexible and expands with less force than a material with a higher modulus of elasticity.

Olefins — Unsaturated hydrocarbon substances (double bond). The most important building blocks (monomers) of the olefins are ethylene, propylene and butylene.

Open System — A circulating hydronic system exposed to atmospheric conditions. Open systems require components resistant to oxidative corrosion. Open systems are the result of continual introduction

of fresh water, open vessels or oxygen diffusion through nonmetallic components.

PE — Abbreviation for polyethylene.

PEX-a — PEX manufactured using the Engel method.

PEX-b — PEX manufactured using the Silane method.

PEX-c — PEX manufactured using the Radiation method.

Polyolefin — A general term for a polymer built from olefins (e.g., polypropylene, polybutylene and polyethylene).

Pressure Loss — The loss of fluid pressure between any two points in a flow-conducting system, expressed in pounds per square inch (psi). The loss of pressure is caused by friction against the tubing walls and is further influenced by the tubing size, length and texture of the inside wall of the tubing, fittings, valves and other components. The temperature and viscosity of the fluid also influence pressure loss.

Primary/Secondary Pumping — The boiler loop with its own circulator is referred to as the primary loop. Secondary loop is any feed from the primary (boiler loop) that is the same or lower temperature with its own circulator for flow control.

R-value — A measure of a material's ability to resist the flow of heat:

- R-value is expressed in BTU/h/ft² (1/U = R).
- R-value is also expressed as the reciprocal of an insulation K factor multiplied by the thickness in inches.

Radiation — The process in which energy in the form of rays of light or heat is transferred from body to body without heating the intermediate air acting as the transfer medium.

SBR — Abbreviation for Styrene Butadiene Rubber, commonly used for gaskets and seals.

Standard Dimension Ratio (SDR) — A specific ratio of the average specified diameter to the minimum specified wall thickness — the smaller the SDR number, the thicker will be the pipe wall thickness.

Thermal Conductivity (K) — A property of materials that indicates the amount of heat (BTU) that penetrates 1 square foot of a uniform material, one inch thick, in one hour for each degree Fahrenheit difference in temperature between the surfaces:

- It is expressed in BTU/h/ft²/°F.
- The thermal conductivity of PEX is 0.22 BTU/h/ft²/°F.

Thermal Mass — Any material used to store heat energy or the affinity for heat energy

Thermal Transfer Coefficient — This describes the transfer of heat from a bordering surface expressed in BTU/h/ ft²/°F. Thermal transfer coefficient is comprised of radiation, convection and conduction properties, as well as the orientation of the radiant surface (floor, ceiling or wall).

U-value — The capability of a substance to transfer heat; it is used to describe the conductance of a material or composite of materials in construction. U-value is expressed in BTU/h/ft² and is the inverse function of R-value ($1/R = U$).

UV-light Stabilizers — Frequently used in plastics, the primary function is to protect the substance from long-term degradation effects from light, most frequently ultraviolet light. Different UV-light stabilizers are utilized depending upon the substrate, intended functional life, and sensitivity to UV degradation.

Velocity — This is the speed of fluid at a specific flow expressed in feet per second (fps).

Section 1:

Uponor Pre-insulated Pipe Systems Overview

Uponor Pre-insulated Pipe systems feature Ecoflex® piping for hot and cold fluid distribution. These coiled, watertight, corrosion-proof pipes are easy to install directly into the excavation site. With coil lengths available up to 600 feet, you will need few, if any, underground joints, resulting in seamless piping runs.

Ecoflex Thermal service pipes consist of durable Engel-method crosslinked polyethylene (PEX-a). Ecoflex Potable HDPE service pipes consist of high-density polyethylene (HDPE).

Protected by multi-layered insulation and a waterproof, corrugated HDPE jacket, Uponor pre-insulated pipes ensure dependable, trouble-free performance for decades.

Features and Benefits

There are many attractive features of Ecoflex as a pipe distribution system:

- **Corrosion-resistant System** — Corrosion-free materials that ensure a long service life for the pipe system
- **Lightweight** — Ecoflex coils that are easy to handle and move around
- **Durable** — A flexible, waterproof system suitable for all soil conditions
- **Flexible** — Multiple insulation layers and corrugated outer jacket
- **Energy-efficient** — Closed-cell PEX insulation foam that retains its insulation capability for the entire service life of the pipe system
- **Easy Installation** — No special tools needed for installation
- **Few Underground Connections** — Long coils that are quick to install, with no additional joints required

Product Line

Uponor Pre-insulated Pipe systems include the Ecoflex product line with separate pipeline systems for heating systems, cooling systems and potable-water supply. Products include:

- Ecoflex Thermal Single
- Ecoflex Thermal Twin
- Ecoflex Potable HDPE
- Product Accessories

Section 2: Products and Hardware

Pre-insulated Pipe Construction

The outer jacket of the Ecoflex pipe is constructed of waterproof, corrugated high-density polyethylene (HDPE). Between the service pipe and the jacket are layers of closed-cell, crosslinked polyethylene (PEX) foam insulation. The service pipe consists of PEX-a or HDPE, depending on the type of Ecoflex:

- For Ecoflex Potable HDPE, the service pipe is HDPE.
- For Ecoflex Thermal Single and Thermal Twin products, the service pipe is PEX-a.

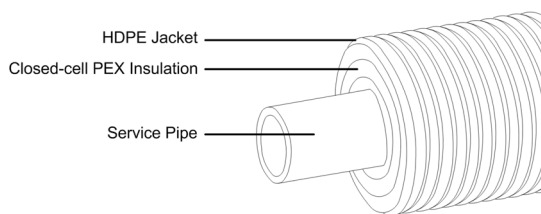

Figure 2-1: Pipe Construction

Jacket

The unique construction of the HDPE corrugated outer jacket results in strength and flexibility — it makes the jacket stiff in the cross-sectional direction and flexible in the longitudinal direction.

| Jacket Sizes | | |
|-----------------|----------------|---------------------|
| Outer Dimension | Wall Thickness | Wall Thickness (mm) |
| 5.5" | 0.079" | 2.1mm |
| 6.9" | 0.059" | 1.5mm |
| 7.9" | 0.047" | 1.2mm |

Table 2-1: Jacket Sizes



Figure 2-2: Pipe Jacket

Closed-cell PEX-foam Insulation

All Uponor pre-insulated piping products feature closed-cell PEX-foam insulation. The closed cellular structure of the insulation prevents water absorption. The insulation quickly regains its original shape after bending.

| Property | Value |
|---|---|
| Density | 2.0 lb./ft. ³ (0.032 kg/dm ³) |
| Thermal Conductivity | 0.28 BTU · in./ft. ² · h · °F (0.037 W/m ²) |
| Tensile Strength | 43 psi (3 bar) |
| Hardness, 40% Compression | 0.25 lb. · in. ² |
| Absorption of Water by Insulation at 68°F (20°C) 24 Hours Immersed in | 2.0% |
| Vapor Permeability | 0.1 g/100 in. ² d (1.5 g/m ² d) |

Table 2-2: Properties of PEX Foam Insulation



Figure 2-3: PEX-foam Insulation

Service Pipes

Uponor offers three types of plastic pipe for chilled fluid, hydronic heating and potable water applications: Ecoflex Thermal, Ecoflex Single, Ecoflex Thermal Twin, and Ecoflex Potable HDPE. These products are similar in design, but have some different characteristics specific to their intended applications.

Uponor Ecoflex Thermal Single and Thermal Twin

The service pipe used in Ecoflex Thermal and Thermal Twin is made of PEX-a. The "PE" refers to polyethylene, the raw material used to make PEX, and the "X" refers to the crosslinking of the polyethylene across its molecular chains. Linking the molecular chains into a three-dimensional network makes PEX remarkably durable within a wide range of temperatures and pressures. Because of the crosslinking process, PEX-a has a high resistance to heat and pressure, good chemical resistance and excellent flow properties. The PEX-a service pipe used in Ecoflex Thermal Single and Ecoflex Thermal Twin has an oxygen diffusion barrier to limit the amount of oxygen migration through the piping wall into the system fluid.

| Property | Temp. | Value |
|----------------------------------|---------------|---|
| Density | --- | 59 lb./ft. ³ (0.945 kg/dm ³) |
| Smoothness Value | --- | 0.02 mil |
| Coefficient of Thermal Expansion | 68°F (20°C) | 78 · 10 ⁻⁶ in./in. · °F (1.4 m/m · °C) |
| | 212°F (100°C) | 114 · 10 ⁻⁶ in./in. · °F (2.05 m/m · °C) |
| Tensile Strength | 68°F (20°C) | 2,800 to 3,800 psi (193 to 262 bar) |
| | 212°F (100°C) | 1,300 to 1,900 psi (90 to 131 bar) |
| Modulus of Elasticity | 68°F (20°C) | 87,000 to 130,000 psi (5,998 to 8,963 bar) |
| | 180°F (82°C) | 44,000 to 58,000 psi (3,033 to 3,999 bar) |

Table 2-3: Properties of PEX-a Service Pipe

Ecoflex Thermal Single

Ecoflex Thermal Single is a service pipe constructed of PEX-a. PEX-a is highly regarded for its exceptional durability and resistance to chemicals. Suitable for fluids from -58°F (14°C) to 203°F (95°C), it offers exceptional performance in a wide variety of applications.

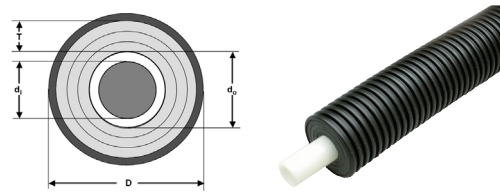

Figure 2-4: Ecoflex Thermal Single Piping

Ecoflex Thermal is available in a single service pipe in ASTM sizes from 1" to 2½".

| Product Number | Description | Jacket Size | Total Foam Thickness | Insulation Value | Service Pipe I.D. | Service Pipe O.D. | Max. Coil Length | Weight per Foot |
|----------------|--------------------|-------------|----------------------|------------------|-------------------|-------------------|------------------|-----------------|
| 5015510 | 1" Thermal Single | 5.5" | 1.77" | R-7.12 | 0.862" | 1.125" | 600' | 0.90 lbs. |
| 5015513 | 1¼" Thermal Single | 5.5" | 1.65" | R-6.66 | 1.054" | 1.375" | 500' | 1.08 lbs. |
| 5016915 | 1½" Thermal Single | 6.9" | 2.13" | R-8.18 | 1.244" | 1.625" | 300' | 1.46 lbs. |
| 5016920 | 2" Thermal Single | 6.9" | 1.93" | R-7.42 | 1.629" | 2.125" | 300' | 1.55 lbs. |
| 5016925 | 2½" Thermal Single | 6.9" | 1.65" | R-6.36 | 2.011" | 2.625" | 300' | 1.94 lbs. |
| 5017930 | 3" Thermal Single | 7.9" | 1.93" | R-7.42 | 2.398" | 3.125" | 300' | 2.80 lbs. |

Table 2-4: ASTM Ecoflex Thermal Single Product Information

Ecoflex Thermal Twin

Ecoflex Thermal Twin features the same characteristics as Ecoflex Thermal Single piping, but features two service pipes in a single outer jacket. It is available from 1" to 2½" ASTM sizes. The outer jacket consists of a corrugated HDPE shell with closed-cell PEX insulation between the HDPE shell and PEX service pipes.

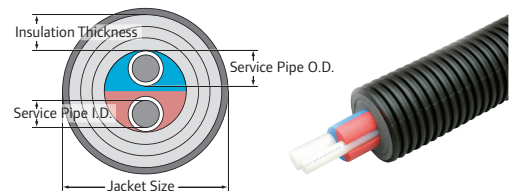

Figure 2-5: Ecoflex Thermal Twin Piping

| Product Number | Description | Jacket Size | Total Foam Thickness | Insulation Value | Service Pipe I.D. | Service Pipe O.D. | Max. Coil Length | Weight per Foot |
|----------------|------------------|-------------|----------------------|------------------|-------------------|-------------------|------------------|-----------------|
| 5026910 | 1" Thermal Twin | 6.9" | 1.54" | R-5.91 | 0.862" | 1.125" | 600' | 1.60 lbs. |
| 5026913 | 1¼" Thermal Twin | 6.9" | 1.34" | R-5.15 | 1.054" | 1.375" | 500' | 1.70 lbs. |
| 5026915 | 1½" Thermal Twin | 6.9" | 1.06" | R-4.09 | 1.244" | 1.625" | 300' | 1.95 lbs. |
| 5027920 | 2" Thermal Twin | 7.9" | 0.95" | R-4.09 | 1.629" | 2.125" | 300' | 3.05 lbs. |
| 5027925 | 2½" Thermal Twin | 7.9" | 0.59" | R-2.27 | 2.011" | 2.625" | 300' | 3.85 lbs. |

Table 2-5: Ecoflex Thermal Twin Product Information

Ecoflex Potable HDPE

Designed specifically for hydronic cooling systems, Ecoflex Potable HDPE features service pipes in ASTM sizes 1¼", 1½", 2", 3" and 4". Ecoflex Potable HDPE offers ease of installation while satisfying the budget-conscious design professional. HDPE is highly respected for its long service life and suitability for many popular cold-water applications.

| Property | Temp | Value |
|----------------------------------|--------------------|---|
| Density | --- | 59 lb./ft. ³ (0.945 kg/dm ³) |
| Smoothness Value | --- | 0.027 mil |
| Coefficient of Thermal Expansion | 68-176°F (20-80°C) | 1.1 · 10 ⁻⁶ in./in.·°F (2.05 m/m · °C) |
| Strength | 73°F (23°C) | 2,901 to 4,351 psi (200 to 300 bar) |
| | 176°F (80°C) | 580 to 870 psi (40 to 60 bar) |
| Modulus of Elasticity | 68°F (20°C) | 87,000 psi (5,998 bar) |
| Thermal Conductivity | --- | 2.64 BTU · in./ft. ² · h · °F (0.38 W/(m·K)) |

Table 2-6: Material Properties of HDPE Service Pipe

Operating Limits:

- 30°F to 73°F (-34°C to 23°C) at 160 psig
- 30°F to 100°F (-34°C to 38°C) at 125 psig
- 30°F to 120°F (-34°C to 49°C) at 101 psig
- 30°F to 140°F (-34°C to 60°C) at 80 psig

The material used in this service pipe is HDPE, developed for cold-water distribution and conforming to the following certifications.

- Standards: PE 3408, PE 3608, AWWA, C901/C906; ASTM F714
- Listings: NSF/ANSI 61 or NSF-pw

The service pipe of Ecoflex Potable HDPE does not feature an oxygen diffusion barrier. The pipe can be connected using traditional connectors, butt-fusion welding or electrical-fusion welding. (Not supplied by Uponor.)

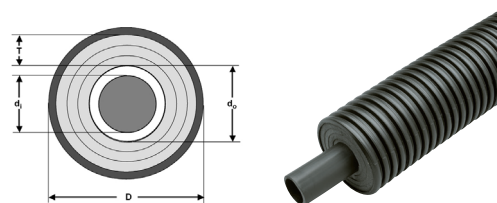

Figure 2-6: Ecoflex Potable HDPE Piping

| Product Number | Description | Jacket Size | Total Foam Thickness | Insulation Value | Service Pipe I.D. | Service Pipe O.D. | Max. Coil Length | Weight per Foot |
|----------------|------------------|-------------|----------------------|------------------|-------------------|-------------------|------------------|-----------------|
| 5115513 | 1¼" Potable HDPE | 5.5" | 1.54" | R-5.91 | 1.368" | 1.660" | 300' | 1.0 lbs. |
| 5115515 | 1½" Potable HDPE | 5.5" | 1.42" | R-5.45 | 1.554" | 1.900" | 300' | 1.0 lbs. |
| 5115520 | 2" Potable HDPE | 5.5" | 1.18" | R-4.54 | 1.943" | 2.375" | 300' | 1.4 lbs. |
| 5116930 | 3" Potable HDPE | 6.9" | 1.18" | R-4.54 | 2.860" | 3.500" | 300' | 2.4 lbs. |
| 5117940 | 4" Potable HDPE | 7.9" | 1.18" | R-4.09 | 3.680" | 4.500" | 300' | 3.6 lbs. |

Table 2-7: Ecoflex ASTM Potable HDPE Product Information

Product Accessories

Uponor offers the following components designed exclusively for use with Uponor Pre-insulated Ecoflex Pipe.

- Rubber End Caps
- ProPEX® Fittings
- WIPEX™ Fittings
- Connection Vaults
- Shrink Sleeves for Connection Vaults
- Insulation Kits
 - Straight Insulation Kits
 - Tee Insulation Kits
 - 90-degree Insulation Kits
 - H-insulation Kits
- Reducer Bushings
- Wall Sleeve with Heat Shrink Kit
- Wall Sleeve
- Compression Wall Seal

Rubber® End Caps

Ecoflex EPDM Rubber End Caps seal the exposed insulation between the jacket and service pipe when you cut the pipe to make a connection. Use the Single End Caps with Ecoflex Thermal Single and Ecoflex Potable HDPE pipes. Use the Twin End Caps with Ecoflex Thermal Twin. Each end cap comes with a stainless steel clamp and an EPDM rubber o-ring.

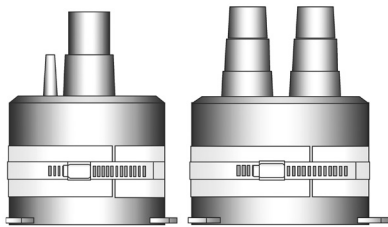

Figure 2-7: Rubber End Caps

ProPEX Fittings

Available in both brass and engineered plastic (EP), Uponor offers a full line of ProPEX fittings designed to ensure strong, reliable connections with Uponor PEX tubing. ProPEX fittings hold tight in strength tests at 1,000 pounds of pull tension. ProPEX fittings easily withstand high temperature and pressures well above ASTM standards.

ProPEX brass adapter transition fittings for connecting metal to PEX and come in a variety of styles for various connection needs.

Some examples include:

ProPEX Brass Fittings — These fittings are available in several sizes and styles, including fittings designed for direct burial in soil. Refer to the Uponor Product Catalog for details.

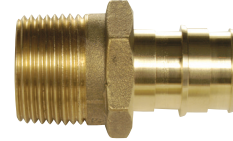

Figure 2-8: ProPEX Brass Fittings Available in Variety of Styles

ProPEX Tees and Elbows — Makes diverting or 90-degree connections for Uponor PEX tubing in supply and return mains. DZR Brass Fittings are safe for direct burial in soil. Styles vary as shown in Figure 2-9.

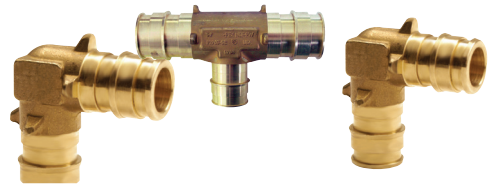

Figure 2-9: DZR Brass Tee, DZR Brass Reducing Tee, DZR Brass Elbow

Note: A ProPEX Expansion Tool is required to create ProPEX fittings and is available from Uponor; ProPEX Rings sold separately. Refer to the Uponor Product Catalog for a complete listing of products available.

EP Fittings

Comprised of thermoplastic, high-performance, advanced materials, EP fittings are available in several styles and are suitable for use under conditions of high impact, heat and moisture. These strong, durable fittings are made of an advanced engineered plastic, highly resistant to corrosive environments. Unaffected by the rising cost of metal, EP fittings are an economical solution for insulated plumbing and heating projects.



Figure 2-10: ASTM F1960 Standard EP ProPEX Insert Fitting

WIPEX™ Fittings

You can use WIPEX fittings with PEX service pipe. WIPEX fittings connect crosslinked polyethylene pipes used with hot-and cold-water systems produced by Uponor. Manufactured from a dezincification resistant alloy, DZR brass, the maximum operating pressure and temperature is 87 psi at 203°F.



Figure 2-11: WIPEX Fittings

Connection Vaults

The Ecoflex Connection Vault makes piping branches, reductions and connections easy. Step-down outlets are compatible with Ecoflex piping. Connection vaults are insulated, watertight and designed for burial below grade. Refer to **Section 3: Design Considerations** for details.

Shrink Sleeves for Connection Vaults

Ecoflex Shrink Sleeves ensure a watertight seal between the Ecoflex pipe and the exterior of the Connection Vault.



Figure 2-12: Shrink Sleeves

Straight Insulation Kits

The Straight Insulation Kit makes an insulated straight connection of single or twin-style Ecoflex products with a jacket size of 5.5", 6.9" and 7.9". The kit features two shells, stainless steel bolts, plastic pins and joint sealing compound. Only use Uponor Rubber End Caps with this kit. The shells of the kit feature an inch of closed-cell PEX insulation sealed with a durable, watertight outer coating. Stainless steel clamps ensure tight closure of the shells over the connection.



Figure 2-13: Straight Insulation Kit

Tee Insulation Kits

The Tee Insulation Kit makes an insulated Tee-connection of single or twin-style Ecoflex products with a jacket size of 5.5", 6.9" and 7.9". The shells of the kit feature an inch of closed-cell PEX insulation sealed with a durable, watertight outer coating. The kit features two shells, stainless steel bolts, plastic pins and joint sealing compound. Reducer bushings are required to fit smaller jacket sizes into the Tee Insulation Kit.



Figure 2-14: Tee Insulation Kit

90-degree Elbow Insulation Kits

The Elbow Insulation Kit makes an insulated elbow connection of single or twin-style Ecoflex products with a jacket size of 5.5", 6.9" or 7.9". You can cut the ends of the elbow to connect to any of these three jacket sizes. The kit features two shells, stainless steel bolts, plastic pins and joint-sealing compound.



Figure 2-15: 90-degree Elbow Insulation Kit

H-insulation Kits

The H-insulation Kit allows for several options of insulated connections between four or five branches of single and twin-style Ecoflex Pre-insulated Pipe with a jacket size of 5.5", 6.9" or 7.9". The kit features two shells, stainless steel bolts, plastic pins and joint-sealing compound.



Figure 2-16: H-insulation Kit

Note: End Caps are required at all ends of the piping system to ensure system integrity. Use these insulation kits with Uponor Rubber End Caps only.

Ecoflex Reducer Bushings

Reducer Bushings adjust the pipe jacket diameter to fit the respective branch diameter on the Straight or Tee Insulation Kits.



Figure 2-17: Reducer Bushings

Wall Sleeve with Heat Shrink Seal Kit

The Wall Sleeve and Heat Shrink Seal Kits offer a simple installation for new block construction or an existing wall with irregular hole. Wall Sleeves, though not engineered for specific bearing loads, offer installation convenience and compatibility.

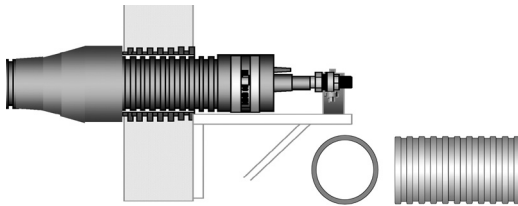

Figure 2-18: Wall Sleeve with Heat Shrink Seal Kit

Wall Sleeve

For new concrete walls, use the Wall Sleeve with the Compression Wall Seal (sold separately). The Wall Sleeve can be field cut for proper fit within concrete forms.

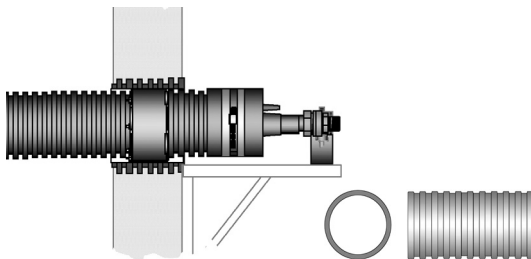

Figure 2-19: Wall Sleeve

Compression Wall Seal

Use the Compression Wall Seal with the Wall Sleeve or use alone when a field core drill is preferred.

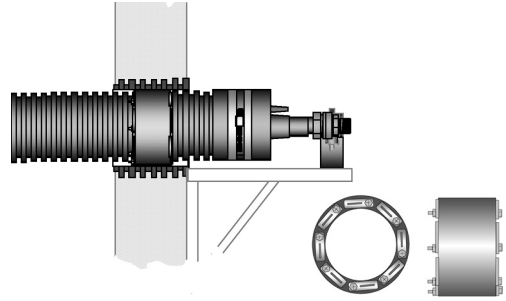

Figure 2-20: Compression Wall Seal

If a filed core drill is preferred, you can use the Compression Wall Seal alone. Refer to **Table 2-8** for the required core drill size.

| Wall Seal Product Number | Jacket Size (inches) | Optimal Core Drill Size (inches) | Wall Seal Length (inches) | Compatible Wall Sleeve |
|--------------------------|----------------------|----------------------------------|---------------------------|------------------------|
| 1007360 | 5.5 | 8.0 | 3.4 | 1007365 |
| 1007361 | 6.9 | 10.0 | 2.7 | 1007366 |
| 1007362 | 7.9 | 12.0 | 2.7 | 1007367 |

Table 2-8: Optimal Core Drill Size

Section 3: Design Considerations

The Uponor Pre-insulated Piping system allows considerable flexibility in underground piping design for the engineer or contractor. Compared with traditional branch piping strategies, the Uponor Pre-insulated Piping system products offer alternatives that will save installation time and improve the overall quality of the system.

Consider the features outlined in this section to design the most cost-effective and energy-efficient system possible. Uponor recommends the system designer become familiar with this manual to ensure proper specifications for your project.

Traditional Piping Versus Ecoflex Design

Traditional rigid pipe systems (steel, copper and most plastic pipes) require some type of connection

about every 20 feet in addition to directional and tee fittings. The system designer typically uses a main line with tee connections positioned to provide perpendicular branch lines to specific locations. Many connections are required below ground. The branch design method also requires constructing straight and level trenches to accommodate rigid pipe, or incorporating costly elevation transitions in the design. The system designer must also install expansion loops to provide for thermal expansion and contraction forces.

Pipe Flexibility

Uponor Pre-insulated Ecoflex Piping offers superior flexibility. The patented closed-cell PEX foam insulation and the corrugated high-density polyethylene (HDPE) outer jacket enable the system designer and installer to avoid many of the expensive and difficult aspects of installing rigid pipe systems. Refer to **Table 3-1** for the bend radius of Ecoflex pipe.

| ASTM Ecoflex Pre-insulated Piping | | | | | | | |
|-----------------------------------|------------------------|--------------|-------------|-------------------|-------------------|------------------|---------------------|
| Product Number | Description | Service Pipe | Jacket Size | Service Pipe I.D. | Service Pipe O.D. | Pipe Bend Radius | Maximum Coil Length |
| 5015510 | Ecoflex Thermal Single | 1" | 5.5" | 0.862" | 1.125" | 10" | 600' |
| 5015513 | Ecoflex Thermal Single | 1¼" | 5.5" | 1.054" | 1.375" | 12" | 500' |
| 5016915 | Ecoflex Thermal Single | 1½" | 6.9" | 1.244" | 1.625" | 14" | 300' |
| 5016920 | Ecoflex Thermal Single | 2" | 6.9" | 1.629" | 2.125" | 18" | 300' |
| 5016925 | Ecoflex Thermal Single | 2½" | 6.9" | 2.011" | 2.625" | 30" | 300' |
| 5017930 | Ecoflex Thermal Single | 3" | 7.9" | 2.398" | 3.125" | 32" | 300' |
| 5026910 | Ecoflex Thermal Twin | 1" | 6.9" | 0.862" | 1.125" | 20" | 600' |
| 5026913 | Ecoflex Thermal Twin | 1¼" | 6.9" | 1.054" | 1.375" | 28" | 500' |
| 5026915 | Ecoflex Thermal Twin | 1½" | 6.9" | 1.244" | 1.625" | 32" | 300' |
| 5027920 | Ecoflex Thermal Twin | 2" | 7.9" | 1.629" | 2.125" | 40" | 300' |
| 5027925 | Ecoflex Thermal Twin | 2½" | 7.9" | 2.011" | 2.625" | 48" | 300' |
| 5115513 | Ecoflex Potable HDPE | 1¼" | 5.5" | 1.358" | 1.660" | 12" | 300' |
| 5115515 | Ecoflex Potable HDPE | 1½" | 5.5" | 1.554" | 1.900" | 14" | 300' |
| 5115520 | Ecoflex Potable HDPE | 2" | 5.5" | 1.943" | 2.375" | 18" | 300' |
| 5116930 | Ecoflex Potable HDPE | 3" | 6.9" | 2.860" | 3.500" | 32" | 300' |
| 5117940 | Ecoflex Potable HDPE | 4" | 7.9" | 3.680" | 4.500" | 48" | 300' |

Table 3-1: ASTM Ecoflex Pipe Bend Radius and Coil Lengths

Longer Pipe Length

Ecoflex is available in coil lengths of 300, 500 or 600 feet, depending on the service pipe size. These longer coil lengths eliminate most, if not all, buried connections and pipe joints.

Fewer buried connections and pipe joints translate to lower labor costs associated with completing below grade connections. It also means a smaller risk of failed joints. Traditional branch design method generally does not make use of the long pipe lengths available with Ecoflex products. Refer to **Table 3-1** for maximum coil lengths available.

Design Layout Options

The Ecoflex system provides the designer with several design layout options to reduce system cost while enhancing performance.

Direct-run Piping

In the case of smaller applications, reduce or eliminate below-grade connections by locating heating or cooling equipment within reach of the standard coil length.

Smaller diameter pipe (1") is available in 600' coils. The largest diameter pipe (4") is available in 300' coils. Refer to **Table 3-1** on page 15 for all coil lengths. Standard coil lengths are suitable for most residential and light commercial projects. Refer to **Figures 3-1** and **3-2**.

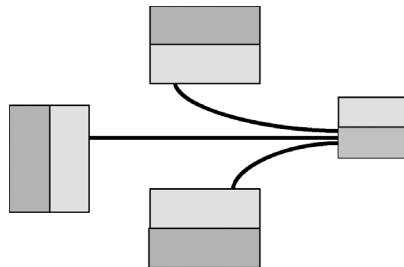

Figure 3-1: Piping Layout Sample



Figure 3-2: Reduce Below-grade Connections

Building-to-Building (Daisy Chain) Piping

In the case of connecting multiple buildings, install pipe from building to building, completing all connections within each structure. This eliminates all below-grade connections, and provides a convenient interior location for all pipe connections. Typically, only a small mechanical area within each structure is required for interior system piping. Refer to **Figures 3-3** and **3-4**.

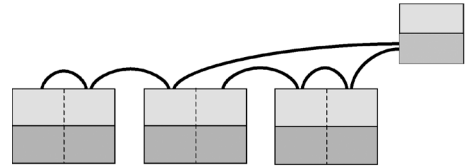

Figure 3-3: Daisy Chain Method

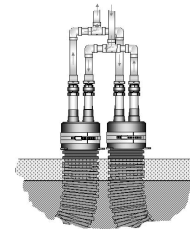

Figure 3-4: Interior Pipe Connections

Pipe Connection Considerations

Insulation Kit Piping

The design plans of your pipe distribution system may include connecting two or more runs of piping and may include a variety of possible configurations. Uponor Pre-insulated Piping Systems feature several types of insulation kits for connecting Ecoflex Thermal Single and Twin piping. These include:

- Straight Insulation Kits — For straight connections between two runs of Ecoflex piping
- Tee Insulation Kits — For tee joint insulated connections between three runs of piping
- 90-degree Elbow Insulation Kits — For elbow insulated connections of Ecoflex piping
- H-insulation Kits — For connections between multiple runs of Ecoflex piping

The Pre-insulated Pipe Systems Insulation Kit makes insulated connections of single or twin-style Ecoflex Pre-insulated Pipe with a jacket size of 5.5", 6.9" and 7.9". The kit features two shells, stainless steel bolts, plastic pins and joint-sealing compound. Refer to **Section 2: Products and Hardware**, for illustrated descriptions of these kits and their functionality.

Refer to **Section 4: Installation Guide** on page **37** for connection examples for insulation lists.

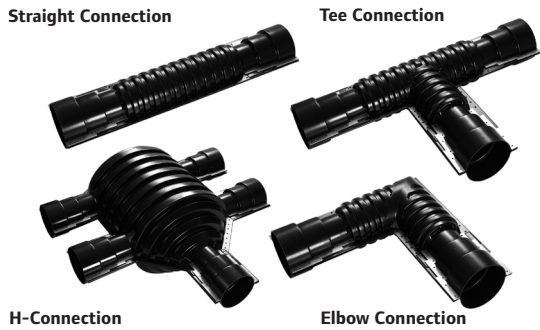

Figure 3-5: Insulation Kits for Pipe Connections

Connection Vault Piping

In systems that require multiple connections, Uponor offers the Connection Vault. It is a pre-insulated, watertight chamber specifically designed for burial below grade. A watertight lid opens to a generous enclosed area for multiple pipe connections. You can assemble and test all distribution connections before making the pipe connections.

The vault is compatible with the 5.5", 6.9", and 7.9" jacket sizes of Ecoflex Thermal Single, Thermal Twin and Potable HDPE pipes. The Uponor Connection Vault is available in styles with six or eight outlets (see **Figure 3-6**). These are particularly suited for larger projects.

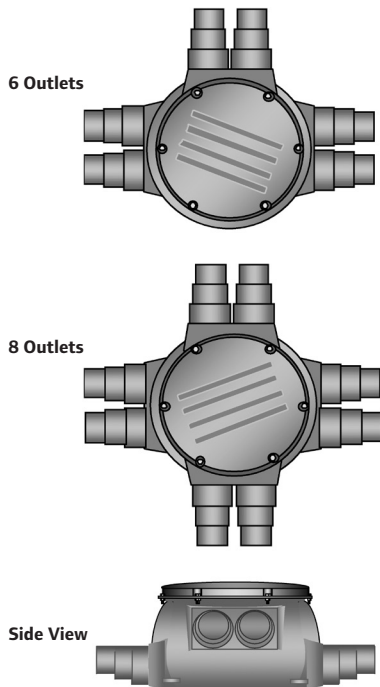

Figure 3-6: Connection Vaults

Uponor recommends that you install the vault in an easily accessible location for future requirements (inspecting connections, adding piping circuits, etc.). Remember that you may need to order any required couplings or unions for these future requirements. We recommend locating the vault in an easily accessible jobsite location for inspecting connections or adding piping circuits.

Note: The Connection Vault requires the following material per outlet used.

| | |
|-------------------------------|-------------------------------------|
| Rubber End Cap | 1 each |
| Male Threaded Adapter Fitting | 1 each (2 each for Thermal Twin) |
| Heat Shrink Sleeve | 1 each |
| Nipples, Tees and Elbows | (varies depending on configuration) |

See **Figure 3-7** for examples of pipe connections made using the Connection Vault.

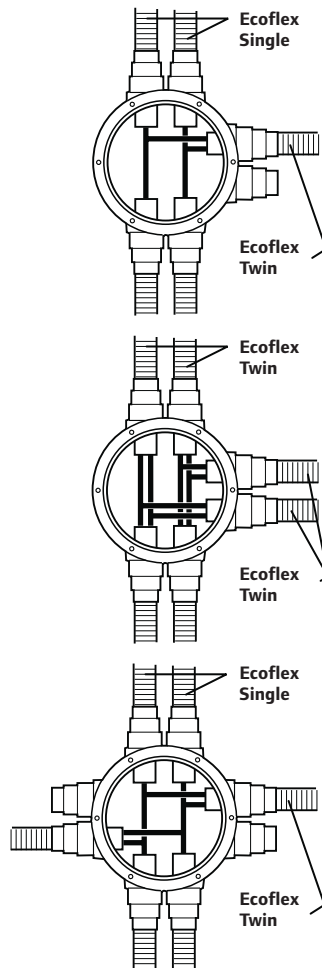

Figure 3-7: Pipe Connection Example

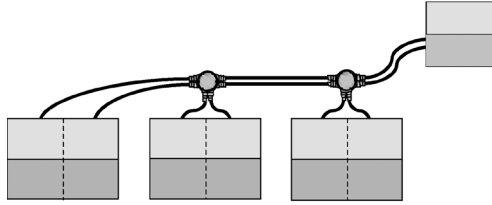

Figure 3-8: Typical Configuration

Figure 3-8 demonstrates the use of connection vaults in a typical configuration. Flow volumes require a separate supply and return pipe (Ecoflex Thermal Single) to the vaults, but thereafter, the installer can use a twin pipe (Ecoflex Thermal Twin) to maximize system efficiency and minimize trench size. Refer to **Figure 3-9**.

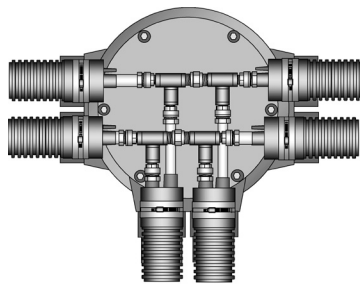

Figure 3-9: Supply and Return to Vault

Pipe-routing Considerations

Obstacle Avoidance

To avoid excavating existing landscaping, dig a trench around the obstacle area. This also applies to existing utilities, such as water, sewer and electrical. In most cases, you can install Ecoflex over or under existing pipes. Ensure proper location and clearance before excavating near utilities. Refer to all state and local codes and authorities for proper application and installation.

When unforeseen below-grade obstacles do arise, such as large boulders or solid rock, simply adjust the elevation of the trench depth, and consider adding backfill to obtain the recommended 2-foot coverage. This feature saves considerable excavation costs if rocky soil conditions are present. When emergency repairs require a temporary solution, or in extreme rocky conditions, you can simply place Ecoflex piping on top of the ground over a sand bed, with a clean fill placed over the piping to the proper thickness. The outer jacket is UV-light stabilized (see glossary), and will not deteriorate over time. However, take care to keep the PEX service pipe away from extended UV-light exposure.

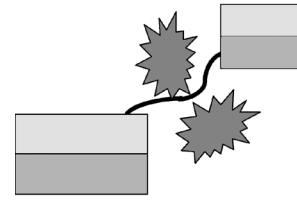

Figures 3-10: UV-stabilized Outer Jacket Prevents Sun Damage

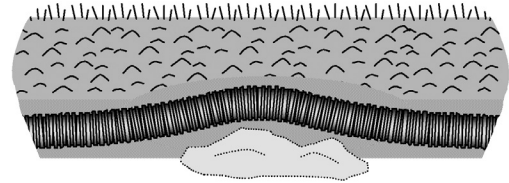

Figures 3-11: Laying Ecoflex Piping

Linear Expansion and Contraction

Expansion loops or special compensation piping that allow linear expansion and contraction are not required when using Ecoflex piping. The unique nature of the service pipe encasement and the expansion absorption intrinsic to these products virtually eliminates the effects of linear expansion. Uponor recommends that you install proper mounting brackets at all transition points to avoid damage caused by linear expansion movement when transitioning to rigid piping systems from the Ecoflex service pipes.

Reduction in Required Fittings

Eliminate the need for 90- or 45-degree fittings to change direction of the piping layout by taking advantage of the flexibility inherent in Ecoflex products. Prepare the trench based on the acceptable pipe bend radius to eliminate additional connections. In addition, directional changes that occur when trenching uphill or down need no special fittings or consideration. Refer to **Table 3-1** on **page 15** for bend radius information.

Energy Savings by Design

Uponor has designed Ecoflex piping and accessories to maximize the energy efficiency of the system. Contamination of an insulated underground piping system by ground water is the highest threat to any pre-insulated distribution system. The Ecoflex watertight HDPE outer jackets provide long-term thermal efficiency for years of trouble-free operation. If an underground connection is required, make sure you install the proper insulation kit and end cap to continue the watertight seal for the system.

Pipe Heat Loss

Based on conventional heat transfer logic, it is important to keep insulation thickness and outer jacket diameter in balance. Excessive insulation requires a larger outer jacket that increases the surface area through which energy is lost. The charts in **Section 6: Appendix B** show that Thermal Twin heat loss per foot is less than an equivalent-sized Thermal Single product when based on two Thermal Single pipes versus one Thermal Twin pipe. We recommend the use of Thermal Twin whenever possible during the design phase of heating systems (see **Figure 3-12**).

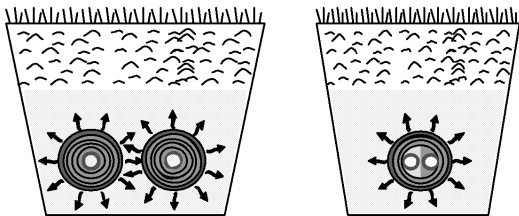

Figure 3-12: Thermal Twin Recommended

For chilled water systems, Uponor recommends Ecoflex Potable HDPE for most applications. The Potable HDPE has less insulation and a proportionately smaller outer jacket than the Thermal products. The reason is simple — the difference between the chilled water design temperature and the soil temperature is not as great as the temperature difference found in heating applications. Therefore, not as much insulation is required in chilled water systems, so the outer jacket circumference is smaller, using less surface area.

Additionally, the use of Ecoflex Thermal Twin products for chilled water systems is discouraged. Thermal Twin products have two service pipes in a single jacket. If the differential temperature of the system is high enough, it is possible that the return fluid temperature could affect the supply temperature more than the energy transfer associated with the surrounding soil.

Selecting System Components

Uponor offers a complete line of accessories as well as the insulation kits and connection vaults described previously. Consult with your local Uponor representative for the pipe connection alternatives that best meet your specific needs. This section describes product accessories available for installing Ecoflex pipe.

Rubber End Caps

Uponor recommends using Uponor Rubber End Caps whenever you terminate the Ecoflex pipe to prevent any contamination from water or other material that could compromise the integrity of the insulated piping system. Rubber End Caps are available for all pipe configurations.

Adapter Fittings

Uponor recommends ProPEX or WIPEX fittings for use with Ecoflex (PEX-a based) products. The WIPEX fitting is designed for connecting Uponor Pre-insulated Pipe of larger diameter size (1" to 4"), with a pressure class of 87 psi to 145 psi. The gripping strength is higher than the tensile strength of the pipe, and the sealing performance is unaffected by temperature fluctuations.

Fusion and Welding Connectors

Ecoflex Potable HDPE service pipe is the only Ecoflex pipe that allows you to use the standard fusion connection techniques such as electrofusion and butt-fusion welding.

Fixing the Pipe

When you join Ecoflex products to other systems, such as mechanical room equipment or existing metal piping, make sure you properly secure the service pipe. Plastic pipes expand and contract dramatically with changes in temperature. To avoid damage to the Ecoflex pipe system and the pipe components adjoined, use a typical bracket and clamp arrangement as shown in **Figure 3-13**.

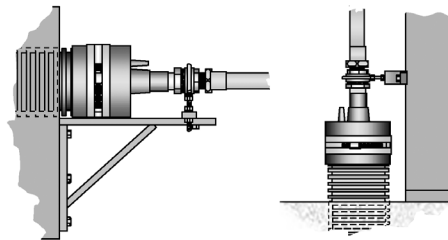

Figure 3-13: Secure Piping with Bracket and Clamp

For larger dimensions, be sure to extend the length of the pipe out of the floor or wall enough to make the pipe relaxed. If the pipe is too short and there are tensions when connecting it, you may experience problems when the system is operational.

Ensure the outer jacket always extends at least 6" beyond finished wall or floor to allow room to install the Rubber End Cap, which provides protection against contamination (such as a boiler leak). Every project is different. You will need to purchase brackets required for your particular configuration

not sold by Uponor. If you have questions about what accessories you may need for your project, ask your local Uponor representative.

Note: All terminations require:

- Rubber End Cap, 1 each
- Male Threaded Adapter Fitting, 1 each (2 each for Thermal Twin)
- Mounting bracket

Wall Penetrations

When penetrating a concrete foundation wall that is required to be watertight, use the installation methods described in this section. Refer to **Section 4: Installation Guide** on **page 25** for detailed installation procedures.

New Concrete Block or Existing Wall — The Wall Sleeve with Heat Shrink Seal Kit includes an 18-inch sleeve and heat shrink sleeve. If watertight penetration of a block wall is required, Uponor offers the Wall Sleeve with Heat Shrink Seal Kit — suitable for block wall installations. You can grout the sleeve into place in the block wall with conventional silicone caulk. The heat shrink seal ensures a watertight connection between the Wall Sleeve and the Ecoflex outer jacket. Uponor recommends routing the pipe as straight as possible through the Wall Sleeve to ensure a proper seal. Refer to **Figure 3-14**. This is also the recommended method for irregular holes in existing walls.

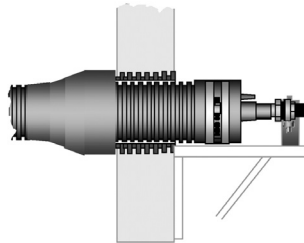

Figure 3-14: Routing Pipe Through the Wall Sleeve

Note: This type of wall penetration requires the Wall Sleeve with Heat Shrink Seal Kit.

New Concrete Wall — When a watertight penetration of a new concrete wall is required, the installer can cut the Wall Sleeve in the field for a proper fit between the concrete forms. The Compression Wall Seal is a mechanical expansion device installed over the pipe and into the Wall

Sleeve to provide a watertight seal.

Note: This type of wall penetration requires:

- Wall Sleeve, 1 each
- Compression Wall Seal, 1 each

Existing Wall with Field Core Drill — The Compression Wall Seal creates a watertight seal between the core drill surface and the outer jacket of the Ecoflex pipe (see **Figure 3-15**).

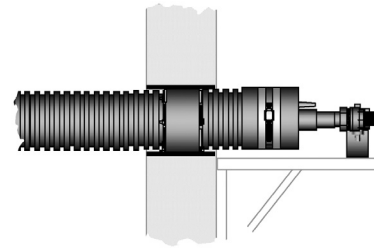

Figure 3-15: Using the Compression Wall Seal

Note: This type of wall penetration requires:

- Core drill, 1 each
- Compression Wall Seal, 1 each

Piping Layout

The underground piping layout can affect the overall cost for materials and labor. Most typical multi-building projects use either a daisy-chain piping layout or a connection vault. If a suitable space exists inside each building to make all piping connections, using the daisy chain piping strategy is the most cost-effective as it avoids the cost of both fitting insulation kits or connection vaults.

Items to Consider in Designing Piping Layout

Piping Distance — The longer the distance between buildings, the higher the pressure loss. This is due to the friction of the fluid passing through the service pipe. Use the shortest possible route, while keeping obstructions and hard soil conditions in mind.

Elevation Changes — Changes in elevation on the project site can dramatically change the length of pipe required. Pay close attention to topographical details on the site plan. In open systems, such as many outdoor furnace installations, circulator placement can have a direct impact on pump cavitation and poor system operation, so it deserves careful consideration. Review the installation suggestions of the manufacturer in this situation. In a closed-loop system, the elevation change does not affect the pressure drop experienced by the circulator.

Moist Soil or High Water Table — Although Ecoflex products are watertight when properly installed, it is best to avoid making connections in areas of highly saturated soil whenever possible. Highly saturated soil offers little insulating quality, and can negatively affect system-operating efficiency.

Heavy Traffic or Roadways — When installing Ecoflex under roadways, take special notice of pipe depth, soil and compaction practices. For H-20 load requirements, install Ecoflex pipe 12" below the designed roadbed with proper compaction. It is also acceptable to install Ecoflex pipe in an approved culvert or conduit for this application.

Installation at Buildings

Uponor recommends avoiding piping connections below grade or in inaccessible areas. The recommendations listed in this section offer solutions for typical installation types.

Slab-on-grade Installation

In most cases, Ecoflex piping makes slab-on-grade installations easy. Ecoflex pipe jackets are safe for direct contact with concrete or mortar. Occasionally, the trench will require additional depth adjacent to the building to accommodate the bend radius of the Ecoflex pipe. To secure the pipe radius during construction, simply use a suitable strap to tie the end of the pipe back a short distance upon itself. Place a reinforcement bar in the soil and secure the pipe to it to avoid lateral movement during construction, as illustrated in **Figure 3-16**.

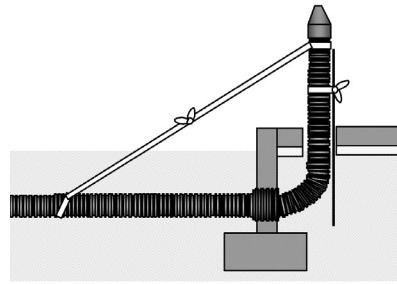

Figure 3-16: Slab-on-grade Installation Example

See **Figure 3-17, 3-18 and 3-19** for other variations of slab-on-grade installation methods.

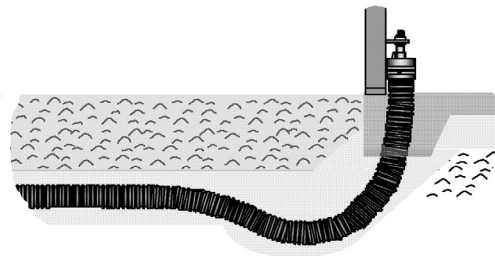

Figure 3-17: Slab-on-grade Installation Example

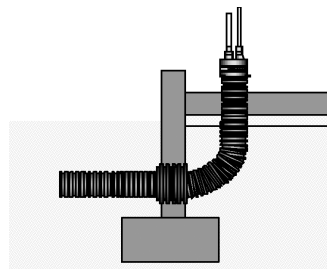

Figure 3-18: Slab-on-grade Installation Example

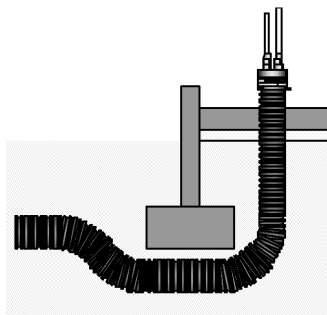

Figure 3-19: Slab-on-grade Installation Example

Dry Well

If you cannot achieve a suitable trench depth to allow for the bend radius, construct a concrete dry well to provide accessible space for fitting connections (see **Figure 3-20**).

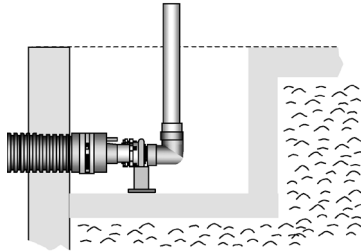

Figure 3-20: Dry Well

Anchoring

When you join Ecoflex products to other systems, such as mechanical room equipment or existing metal piping, it is important to secure the service pipe properly. Plastic pipes expand and contract with changes in temperature. To avoid damage to the Pre-insulated Pipe system and the pipe components adjoined, install a typical bracket and clamp arrangement as illustrated in **Figure 3-21**.

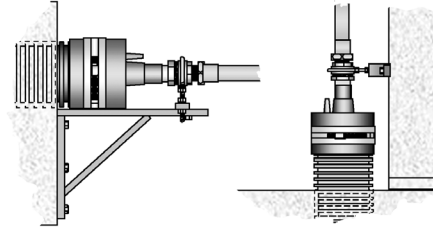

Figure 3-21: Anchoring

Note: Ensure the outer jacket always extends at least 6" beyond the finished wall or floor to allow room for installation of the Rubber End Cap.

Piping Selection

Uponor Pre-insulated Piping systems offer a variety of pipe types and styles designed for specific applications. Ecoflex Thermal Single and Ecoflex Thermal Twin feature crosslinked polyethylene service pipe and are designed for hydronic heating and potable water systems. Ecoflex Potable HDPE features HDPE service pipe for chilled water and cooling systems. It is important to select the proper Ecoflex product based on the design specifications for your system. **Table 3-2** outlines key product characteristics to help you determine the best choice for your application.

| Application | Thermal Single | Thermal Twin | Potable HDPE |
|---|-----------------------|-----------------------|--------------------------|
| Service Pipe | PEX | PEX | HDPE |
| Oxygen Diffusion Barrier | Y | Y | N |
| Single Pipe System | Y | N | Y |
| Twin Pipe System (Supply & Return in Single Jacket) | N | Y | N |
| Service Pipe Sizes Available | 1", 1¼", 1½", 2", 2½" | 1", 1¼", 1½", 2", 2½" | 1", 1¼", 1½", 2", 3", 4" |
| Available Cut to Measure | Y | Y | Y |
| Suitable for Fluid Temperatures ≤ 203°F (95°C)*** | Y | Y | N |
| Suitable for Fluid Temperatures ≤ 140°F (60°C)*** | Y | Y | Y |
| Suitable for System Pressures (at temp) ≤ 87 psi/6 bar*** | Y | Y | Y* |
| Recommended for Potable Installations | N | N | Y* |
| Recommended for Heating Systems | Y | Y | Y* |
| Recommended for Cooling Systems | N** | N** | Y |
| Recommended for Combined Heating and Cooling Systems | Y | Y | Y* |
| Relative Highest System Efficiency | Better | Best | Good |

Table 3-2: Ecoflex Applications

*See temperature and pressure rating for the pipe. For heating and cooling applications, note that HDPE pipe does not have an oxygen barrier.

**Thermal pipes are suitable for cooling if an oxygen barrier is required. However, if an oxygen barrier is not necessary, use Potable HDPE pipes.

***See pipe specifications on page 11 for details

In a heating or cooling system, it is important to understand the heating and cooling load for each structure. Insufficient or excessive fluid flow can affect overall system performance. If this information is unknown, you should have a trained HVAC professional perform a complete heat loss or cooling load calculation for each structure. For potable water systems, refer to local code requirements based on the type, size and purpose of structure.

The following steps outline a simple procedure to determine the required service pipe size:

1. Select a basic layout design format (direct run, building-to-building, connection vaults or a combination).
2. Determine the flow requirements — gallons per minute (gpm) — for each leg of the piping layout.
3. Determine the fluid temperature (°F) of the system supply.
4. Determine the fluid mix that is required (e.g., 100% water or a glycol mixture).
5. From the Ecoflex Pressure Loss Charts (see **Section 5: Appendix A**), determine the service pipe required using the following criteria.
 - a. Flow in gallons per minute for the segment of pipe selected
 - b. Supply fluid temperature
 - c. Type of fluid — percentage of glycol in the system or pure water

Note: Fluid velocity should be greater than 2 feet per second (fps) and less than 8 fps for pipe smaller than 2½" diameter. Pipe that is 2½" and larger can have velocities up to 10 fps.

- d. Total pressure loss should meet design criteria for circulating pump(s).

Note: It may be necessary to adjust Ecoflex pipe sizes or circulating pumps to achieve the designed performance criteria.

Calculate Ecoflex pipe energy loss by referring to Energy Loss Charts in **Section 6: Appendix B**. Determine the estimated soil temperature and average fluid temperature during design conditions. The temperature differential (ΔT) is the difference between the fluid and the ground temperatures.

Estimating Labor

One of the greatest benefits of using Ecoflex products is the savings in installation time. Long coil length means fewer connections in a properly designed system. The flexibility of Ecoflex lets you avoid obstacles, such as boulders and landscaping — not to mention hidden obstacles below the surface that might otherwise require extensive cost and time. You can also save time by using unique Uponor products made for Ecoflex, such as the Connection Vault and Piping Uncoiler, which will multiply your cost benefits. Refer to **Tables 3-3** through **3-6** for an estimate of the time required to install Ecoflex products. The quick learning curve associated with Ecoflex products will enhance this estimate dramatically.

| Estimated Installation Time — Ecoflex Thermal Single Service Pipe | | |
|---|---------------------|-----------------|
| Pipe Size | Number of Mechanics | Time in Minutes |
| 1" | 2 | 0.60/ft. |
| 1¼" | 2 | 0.60/ft. |
| 1½" | 2 | 0.60/ft. |
| 2" | 2 | 0.60/ft. |
| 2½" | 2 | 0.60/ft. |
| 3" | 3 | 0.90/ft. |

Table 3-3: Time Estimate for Single Service Pipe

| Estimated Installation Time — Ecoflex Thermal Twin Service Pipe | | |
|---|---------------------|-----------------|
| Pipe Size | Number of Mechanics | Time in Minutes |
| 1" | 2 | 0.70/ft. |
| 1¼" | 2 | 0.70/ft. |
| 1½" | 2 | 0.70/ft. |
| 2" | 2 | 0.70/ft. |
| 2½" | 3 | 0.70/ft. |

Table 3-4: Time Estimate for Twin Service Pipe

| Estimated Installation Time — Ecoflex Potable HDPE Service Pipe | | |
|---|---------------------|-----------------|
| Pipe Size | Number of Mechanics | Time in Minutes |
| 1¼" | 3 | 0.90/ft. |
| 1½" | 3 | 0.90/ft. |
| 2" | 3 | 0.90/ft. |
| 3" | 3 | 0.90/ft. |
| 4" | 4 | 0.90/ft. |

Table 3-5: Time Estimate for Potable HDPE Service Pipe

| Estimated Installation Time — Ecoflex Accessories | | |
|---|---------------------|-----------------|
| Part | Number of Mechanics | Time in Minutes |
| Male Threaded Adapter | 1 | 15 / ea. |
| Rubber End Cap | 1 | 10 / ea. |
| Straight Insulation Kit | 1 | 30 / ea. |
| Tee Insulation Kit | 1 | 40 / ea. |
| 90-degree Insulation Kit | 1 | 30 / ea. |
| H-connection Insulation Kit | 1 | 50 / ea. |
| Connection Vault | 1 | 10 / ea. |
| Shrink Sleeve | 1 | 10 / ea. |
| ProPEX Connection | 1 | 3 to 5 / ea. |

Table 3-6: Time Estimate for Accessories

Section 4: Installation Guide

Handling and Storing Pipe Coils

Uponor Pre-insulated Ecoflex Piping is available in coils. Verify that the contents of the Ecoflex delivery match the packing list. Contact your local Uponor representative for any discrepancies.

Delivery Contents

- Pipe coil wrapping material
- Product label
- Protective end covers
- Packing straps
- Unloading and handling instructions
- Quality control sticker

Make sure protective end caps are in place. If not, install protective end covers on pipe ends to protect the pipe from dirt, debris and other damage. Keep these protective end covers on the pipe until making final piping connections.



Caution: Protect the pipe coil from sharp objects during transport and storage.

Unloading

Before unloading, thoroughly inspect all material for shipping damage. Pipe damage is difficult to see, and occasionally occurs on the inside radius of the coil — typically in the form of a rip or tear in the outer jacket.

Note: Refuse any shipment that has product damage and contact Uponor immediately. Review the product label to verify the type of product and coil length.

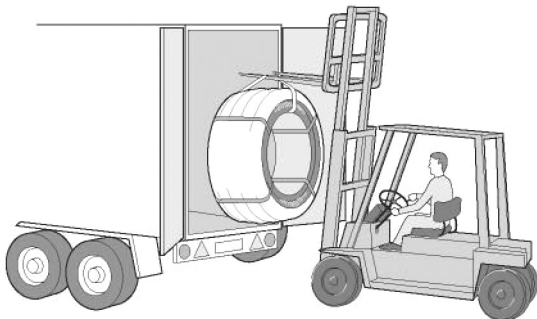

Do not remove outer plastic wrap or nylon straps before you are ready to install. See **Uncoiling the Pipe** section on page 26.

Always lift coils from the transport vehicle using a wide 2" strap around the coil. To avoid damage, do not drop from truck bed or from similar elevation, or drag the coils over coarse or sharp surfaces. You can move coils over short distances by rolling.

Do not lift coils with any sharp object (including equipment forks) unless wrapped with foam rubber or other material (see **Figure 4-1**).

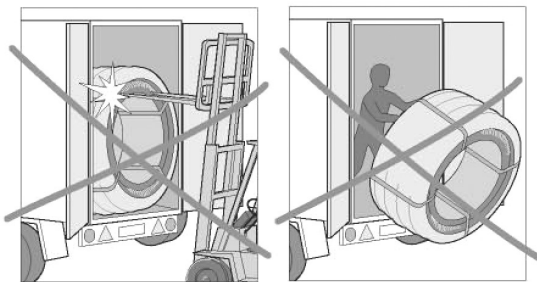

Storage

To ensure coils are not bent or flattened during storage, store the coils in an upright position (see **Figure 4-2**). You may store pipe coils and connection vaults outside. Store all other system parts in a cool, dry area.

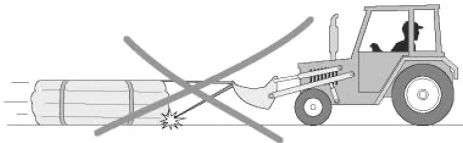

Figure 4-1: Unloading the Pipe

Figure 4-2: Store in Upright Position

Pipe Installation

Uncoiling the Pipe

Ecoflex pipe may be uncoiled and installed directly into the trench depending upon the service pipe, jacket size and ambient temperature.

For best results, uncoil the pipe in advance of installation to allow the pipe to relax and become more manageable during the installation process. If room permits, uncoil pipes adjacent to trenches and allow them to relax for 24 hours. In cold climates, the relaxing period may take longer. Uponor recommends allowing at least two extra feet on each end before cutting.

Note: Inspect the pipe for any damage before uncoiling, and contact your Uponor representative if damaged.

Uncoiling Small Dimension and Short Lengths

To install small dimension or short lengths of Ecoflex pipe, simply remove the nylon straps and uncoil, beginning with the innermost end and unrolling adjacent to the trench.

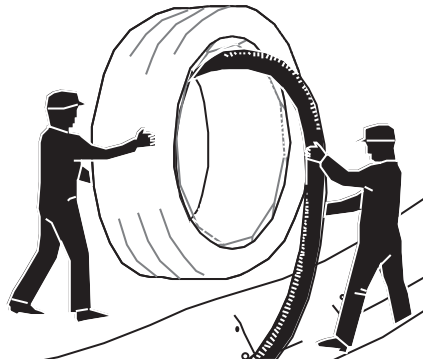

Figure 4-3: Uncoiling Short Lengths



Do not remove the exterior plastic wrap during the uncoiling process.

Do not remove the protective end covers until you make the final connection. The covers protect the pipe ends from dirt, debris and damage.

Avoid unrolling or dragging the coil over sharp objects.

Uncoiling Large Dimension and Long Coils

Use a mechanical uncoiler to uncoil larger dimension and long coils of Ecoflex.

1. With the coil in its upright position, remove the outer wrap completely from the coil.
2. Adjust the coil so that the outermost pipe end is opposite the direction of the uncoiling path and is located at ground level.

3. Secure the service pipe (PEX or HDPE) to a fixed point (such as a tree, building or concrete block).

Note: Do not secure the jacket only as this will damage the product.

4. Untie one strap at a time while slowly uncoiling until all straps are uncoiled. Use caution cutting the last strap since the pipe may shift.



Caution: When finished uncoiling or moving to a new location, always re-tie straps; loose pipe may cause injury. Do not remove the protective end covers until you make the final connection. The covers protect the pipe ends from dirt, debris and damage.

Inspect Pipe for Damage

Carefully inspect the jacket pipe for any damage. Refer to the **Jacket Repair** section on **page 43** for information about repairing the jacket pipe. Call Uponor if you discover damage to the service pipe.

Note: To ensure system integrity, do not install damaged pipe. Installing damaged product may void the manufacturer's warranty.

Pipe Bending Radius

Never bend the pipe more than the bending radius allowed as shown in **Table 4-1**. The bending radius corresponds to values achieved in normal jobsite conditions in 68°F (20°C) weather during manual installation.

| Ecoflex Thermal Single | | Ecoflex Thermal Twin | | Ecoflex Potable HDPE | |
|------------------------|-------------|----------------------|-------------|----------------------|-------------|
| Pipe Size | Bend Radius | Pipe Size | Bend Radius | Pipe Size | Bend Radius |
| 1" | 10" | 1" | 20" | 1¼" | 12" |
| 1¼" | 12" | 1¼" | 28" | 1½" | 14" |
| 1½" | 14" | 1½" | 35" | 2" | 18" |
| 2" | 18" | 2" | 40" | 3" | 32" |
| 2½" | 30" | 2½" | 48" | 4" | 48" |
| 3" | 30" | 2½" | 48" | 4" | 48" |

Table 4-1: ASTM Ecoflex Size and Bend Radius

Installation in Cold Climates

Uponor does not recommend installing Ecoflex piping when temperatures fall below 5°F (-15°C). In cold weather, installation becomes easier if you allow the coil to warm in advance by storing in a heated area or using hot air fans.



Caution: Do not heat the pipe with a torch or open flame.

Trench Preparation

Place all excavation material on one side of the trench to allow space for uncoiling the pipe on the other side.

Determine the trench depth and width by the jacket size and the quantity of the Ecoflex pipes:

The recommended burial depth of Ecoflex pipe is a minimum of 12" above the top of the pipe.

Allow for 4" of clearance between the jacket and the bottom edge of the excavated trench. When you are installing multiple pipes, allow at least 2" of clearance between the pipes for adequate compaction.

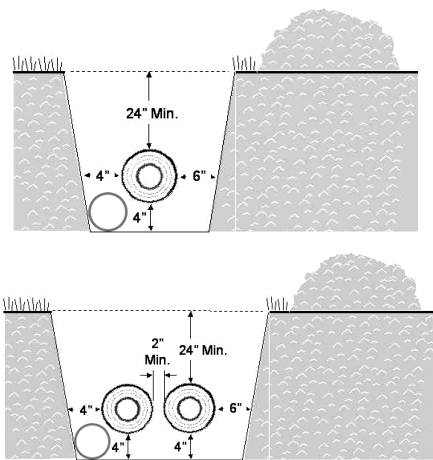

Figure 4-4: Trench Preparation

To achieve the highest energy-efficiency, bury Ecoflex piping at a depth that will avoid severe temperature differentials between fluid temperature and ambient soil temperature.

The greater the difference between fluid temperature (180°F) and ambient soil temperature (50°F), the greater the heat loss. For example, if the pipe is buried too shallow in freezing ground (35°F), the heat loss will be greater than if buried below the frost line (50°F).

The following steps and illustrations indicate recommended trench dimensions based on the number and configurations of the piping installed.

When installing Ecoflex in areas with high water table or when wet soil conditions may occur Uponor always recommends installing a drain pipe in the sandbed below the Ecoflex pipe(s).

Note: Consult with local building inspectors to determine if proper trench shoring is required for worker safety.

1. Install 4" of sand (or other suitable fill) into the excavation site for bedding material. Ensure the fill is free of sharp objects.

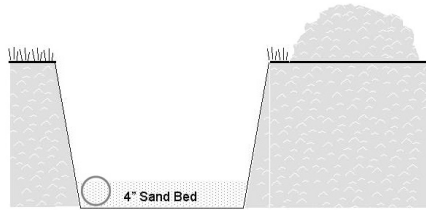

Figure 4-5: Trench Preparation

2. Install Ecoflex pipes, maintaining proper clearance between the trench wall and other pipes.

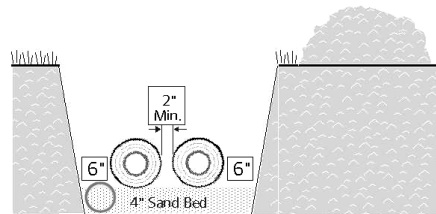

Figure 4-6: Trench Preparation

3. Fill the trench, free of sharp objects, halfway up the Ecoflex pipes, and manually compact.

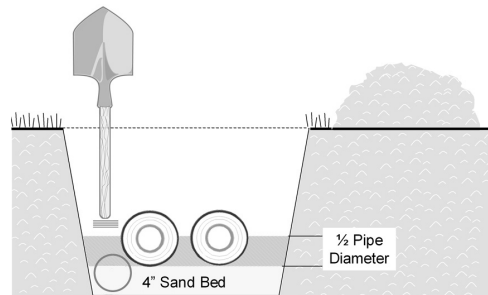

Figure 4-7: Trench Preparation

4. Install the final fill, free of sharp objects, frozen lumps or any object that could damage the outer jacket, to 12" above the top of the pipe, and compact using mechanical compaction equipment.

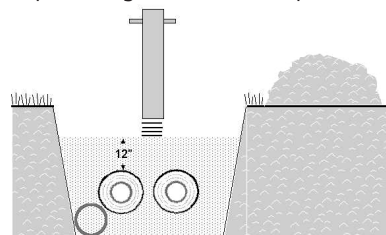

Figure 4-8: Trench Preparation

5. Refill the trench with native soil. Then compact the soil for final cover.

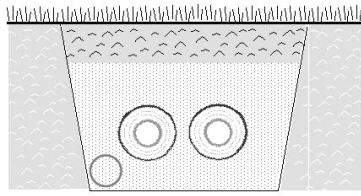

Figure 4-9: Trench Preparation

Note: When installing Ecoflex pipes under a roadway, follow the same procedure as indicated previously, with the following exception: Ensure the top of the piping is 16" below the bottom of the roadbed material as specified. You can also use a suitable steel or structural conduit to sleeve the Ecoflex pipe.

Note: Due to smoke and fire restrictions, Uponor does not approve Ecoflex piping for installation within occupied buildings.

Ecoflex Pipe Preparation

Always inspect the starting pipe end before final cutting. Remove the protective pipe cover to ensure adequate service pipe length and desired size. We recommend allowing at least 24" of extra pipe on each end.

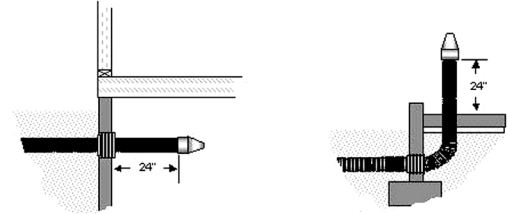

Figure 4-12: Allow 24" of Extra Pipe at Ends

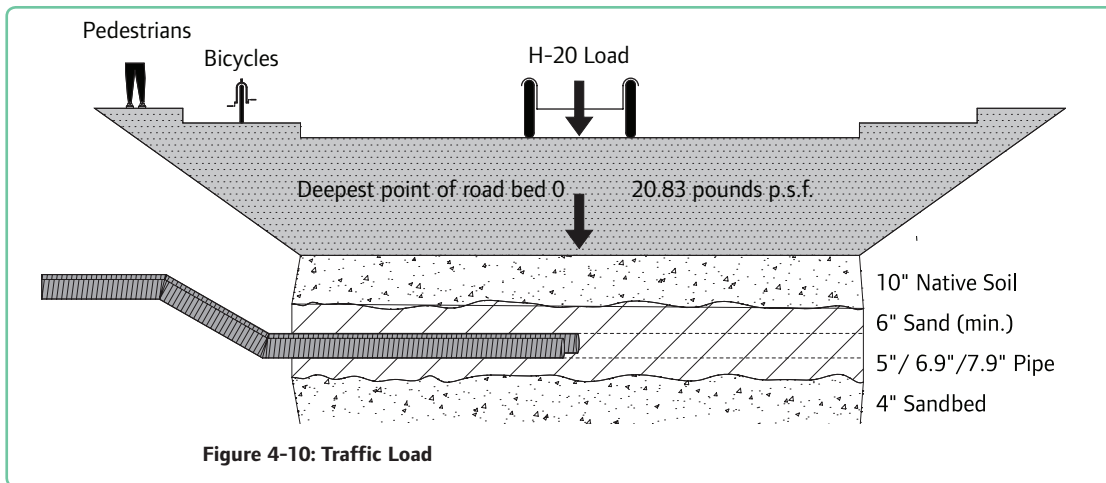

Figure 4-10: Traffic Load

Wall or Ceiling Installation

To install in a wall or ceiling, use suitable brackets.

Install the pipe brackets as indicated in **Figure 4-11** to prevent the pipe from bending between mounting points. For horizontal installations, use standard loop or clevis hangers with pipe saddles. For vertical installations, use standard riser clamps. In all cases, avoid damaging the outer jacket.

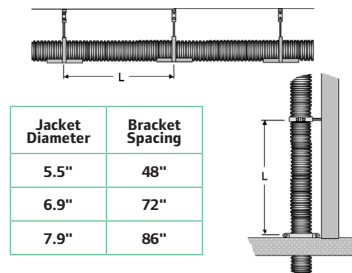

Figure 4-11: Wall and Ceiling Installation

When installing in a concrete slab, always leave at least 6" of the jacket above the finished floor elevation to allow for accessory installation and to protect against water contamination in the event of a flood or mechanical equipment failure.

Tools Required

- Hand saw
- Sharp razor knife
- Tape measure
- Clean rag

1. Using a handsaw or similar tool cut the Ecoflex pipe.

Note: Allow two extra feet of pipe at each end.

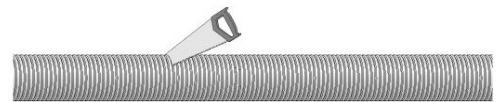

Figure 4-13: Cutting Pipe



Caution: When preparing a pipe end for installation using an insulation kit, see the insulation kit instructions for cutting details.

2. Measure 8" from end of the pipe, and using a sharp razor knife, slice through the jacket around the circumference and remove. It may be necessary to continue by cutting the jacket from the circumference to the rough end of the pipe as shown in **Figure 4-14**.

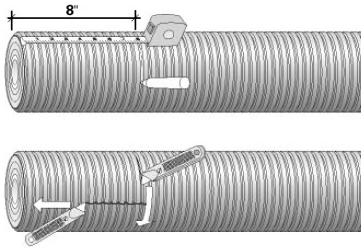

Figure 4-14: Measure and Cut Outer Jacket

3. Pull jacket apart and remove to expose the insulation layers.



Figure 4-15: Remove Jacket

4. Using a sharp razor knife carefully cut away insulation layers.



Caution: Avoid cutting or scratching the service pipe.

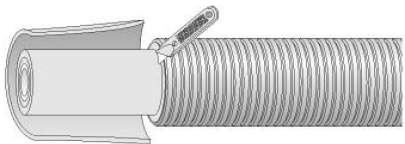

Figure 4-16: Remove Insulation

5. Using a clean rag, remove all dirt and debris from the service pipe.

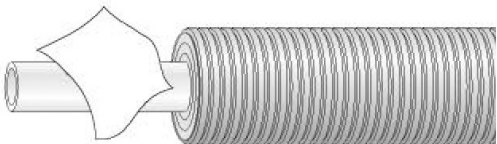

Figure 4-17: Clean the Service Pipe

Installing the Ecoflex EPDM Rubber End Cap

Uponor Pre-insulated Pipe Systems feature EPDM Rubber End Caps. EPDM Rubber End Caps seal the exposed insulation between the jacket and service pipe when cut to make a connection.

Designed for maximum flexibility and durability, this end cap includes an EPDM o-ring and stainless steel clamp for a watertight connection. End caps are required at all ends of the piping system, above or below grade, to ensure insulation integrity in the Pre-insulated Pipe system.

Tools Required

- Sharp scissors
- Pipe lubricant (soap)
- Screwdriver
- Clean rag

EPDM Rubber End Cap Instructions

1. Prepare pipe end.
 - a. Inspect starting pipe end before final cutting.
 - b. Remove the protective pipe cover to ensure adequate service pipe length and desired size.

Note: Uponor recommends at least 24" of extra pipe on each end.
 - c. Cut the pipe using a handsaw or similar tool, allowing two extra feet at each end.
 - d. Measure 8" from the end and cut the outer jacket.
 - e. Remove the jacket.
 - f. Remove the insulation carefully, using a sharp razor knife.

Note: If an insulation kit is required, refer to the instructions included with the insulation kit and disregard the following steps.

2. Wipe all dirt and debris from service pipe and jacket with a clean rag.
3. Verify the service pipe size and cut off the unneeded portion of the Rubber End Cap with sharp scissors. Refer to **Table 4-2** along with **Figure 4-18** on **Page 30** to identify where to make the cut.

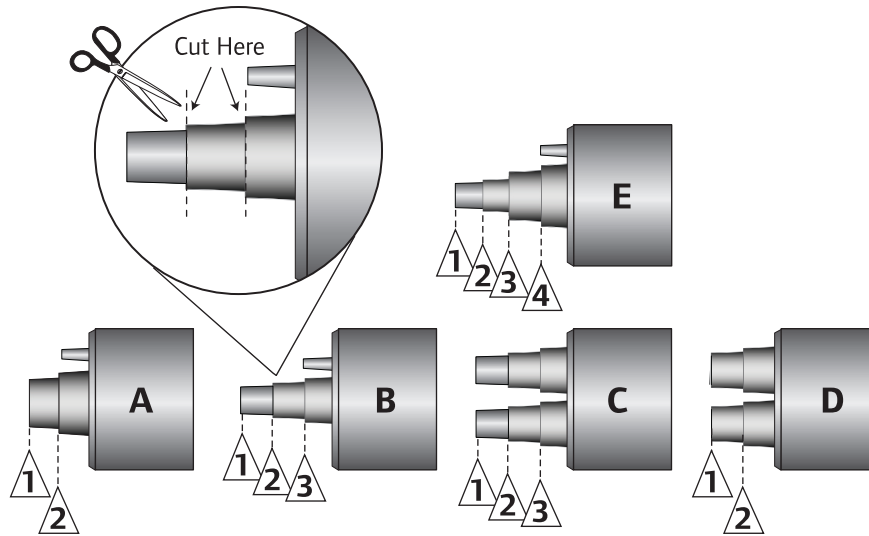

Figure 4-18: End Cap Cut Locations

| End Cap Cut Locations | | | | | | |
|-----------------------------|----------------|--------------|-----------------|---------------------|---------------|--------------|
| ASTM Ecoflex Product Number | Description | Service Pipe | Jacket Diameter | End Cap Part Number | End Cap Style | Cut Location |
| 5015510 | Thermal Single | 1 | 5.5 | 5855513 | A | 1 |
| 5015513 | Thermal Single | 1¼ | 5.5 | 5855513 | A | 2 |
| 5016915 | Thermal Single | 1½ | 6.9 | 5856930 | E | 1 |
| 5016920 | Thermal Single | 2 | 6.9 | 5856930 | E | 2 |
| 5016925 | Thermal Single | 2½ | 6.9 | 5856930 | E | 3 |
| 5017930 | Thermal Single | 3 | 7.9 | 5857940 | E | 1 |
| 5017935 | Thermal Single | 3½ | 7.9 | 5857940 | E | 2 |
| 5017940 | Thermal Single | 4 | 7.9 | 5857940 | E | 3 |
| 5026910 | Thermal Twin | 1 | 6.9 | 5956915 | C | 1 |
| 5026913 | Thermal Twin | 1¼ | 6.9 | 5956915 | C | 2 |
| 5026915 | Thermal Twin | 1½ | 6.9 | 5956915 | C | 3 |
| 5027920 | Thermal Twin | 2 | 7.9 | 5957925 | D | 1 |
| 5027925 | Thermal Twin | 2½ | 7.9 | 5957925 | D | 2 |
| 5112708 | Potable HDPE | ¾ | 2.7 | 5852710 | A | 1 |
| 5112710 | Potable HDPE | 1 | 2.7 | 5852710 | A | 2 |
| 5115513 | Potable HDPE | 1¼ | 5.5 | 5855520 | B | 1 |
| 5115515 | Potable HDPE | 1½ | 5.5 | 5855520 | B | 2 |
| 5115520 | Potable HDPE | 2 | 5.5 | 5855520 | B | 3 |
| 5116930 | Potable HDPE | 3 | 6.9 | 5856930 | E | 4 |
| 5117940 | Potable HDPE | 4 | 7.9 | 5857940 | E | 4 |

Table 4-2: Rubber End Cap Cut Locations

- Lubricate the service pipe and jacket with soap or similar material. Lubricate the inside of the end cap.

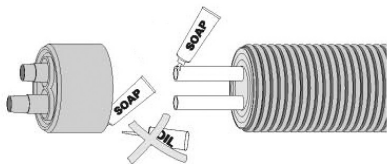

Figure 4-19: Lubricate Pipe



Caution: Do not use oil-based lubricants.

- Pull the Rubber End Cap over the service pipe and jacket until the end cap base is flush with the end of the jacket material.

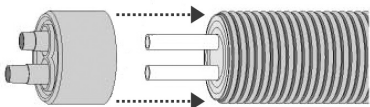

Figure 4-20: Install End Cap

- From the end of the jacket, install the EPDM o-ring in the second groove just past the second full corrugation peak.

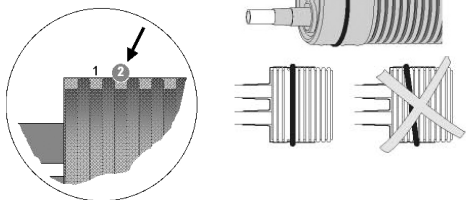

Figure 4-21: Install O-ring

- Install the stainless steel strap over the center of the EPDM o-ring, and tighten using screwdriver until stainless steel shields butt together.

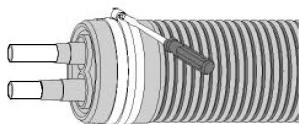

Figure 4-22: Install Steel Strap

Installing WIPEX Fittings

Uponor's WIPEX fittings are manufactured from a dezincification-resistant alloy, DZR brass, and are specifically designed for connecting 1" to 4" Uponor PEX tubing within the Ecoflex Pre-insulated Pipe system. The unique design of the WIPEX fitting features an eccentric outer sleeve for easier grip and an even force when inserting the tubing. The inner sleeve features a threaded profile and includes an o-ring to ensure a secure, tight seal (see **Figure 4-23**). The maximum operating pressure and temperature for WIPEX fittings is 87 psi at 203°F.

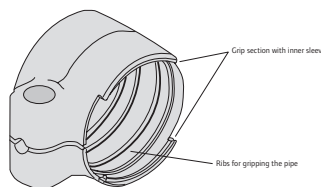

Figure 4-23: Eccentric Design of the WIPEX Fitting

Check the contents of this package. For damaged or missing contents, please contact your Uponor sales representative or distributor for assistance.

The package includes:

- WIPEX fitting(s)
- O-rings
- Bolts, washers and nuts
- WIPEX Fittings Instruction Sheet

Tools and Parts Required

- Plastic pipe cutter
- Low-friction lubrication (MoS2)
- De-burring tool or knife
- Wrench (See **Table 4-3** for sizes.)

| Size of Pipe | Wrench Size |
|-------------------|-------------|
| NPT 1" x PEX 1" | FD 2 – 10mm |
| NPT 1¼" x PEX 1¼" | FD 2 – 10mm |
| NPT 1½" x PEX 1½" | FD 2 – 13mm |
| NPT 2" x PEX 2" | FD 2 – 13mm |
| NPT 2" x PEX 2½" | FD 2 – 17mm |
| NPT 2½" x PEX 3" | FD 2 – 19mm |
| NPT 3" x PEX 3½" | FD 2 – 24mm |
| NPT 4" x PEX 4" | FD 2 – 24mm |

Table 4-3: Wrench Sizes for Piping

WIPEX Fittings Instructions



Important: Read these instructions completely before beginning installation. If you have any questions about these instructions, please contact your Uponor sales representative or distributor for assistance.

1. Cut the tubing with an appropriate plastic-pipe cutter. If using another method for cutting the tubing, make sure you remove the shavings inside the pipe before installing the fitting to avoid blocking valves.



Figure 4-24: Cut the Pipe

2. Chamfer the tubing bore with a de-burring tool or knife and remove any external burrs. This prevents the o-ring from damage or dislodging from its groove after installation.



Figure 4-25: Chamfering

3. Use a suitable pair of pliers to dismount the outer sleeve. For an example of suitable pliers, see **Figure 4-27**.

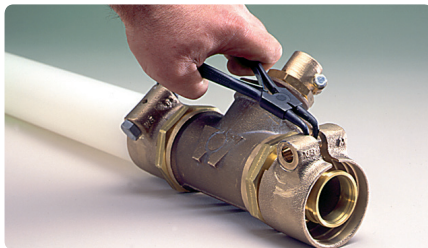

Figure 4-26: Dismounting Outer Sleeve

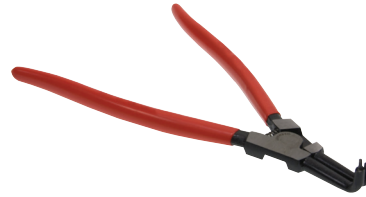

Figure 4-27: Example of Suitable Pliers

4. Place a bolt head between the pads and remove the outer sleeve.

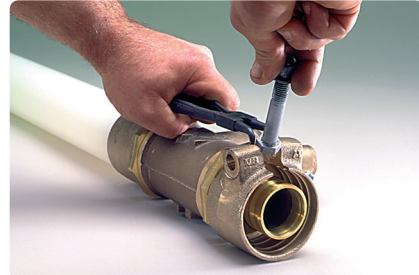

Figure 4-28: Insert Bolt Head

5. Mount the outer sleeve onto the tubing. Make sure you position the outer sleeve correctly toward the inner sleeve so the locking grooves engage.

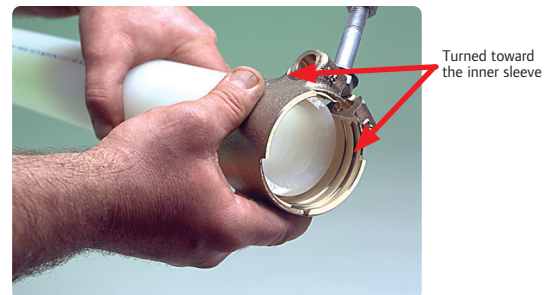

Figure 4-29: Mount the Outer Sleeve

6. To ensure easy mounting of the pipe onto the inner sleeve, lubricate the o-ring, preferably with an environmentally friendly silicone spray or soap.

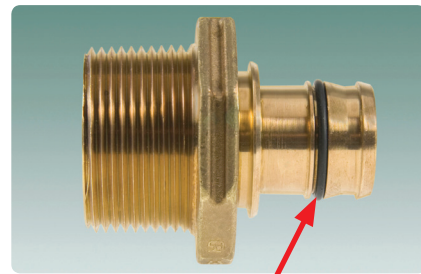

Figure 4-30: Lubricate the O-ring

- Mount the pipe on the insert sleeve and push the outer sleeve until you reach the stop support for the tubing.

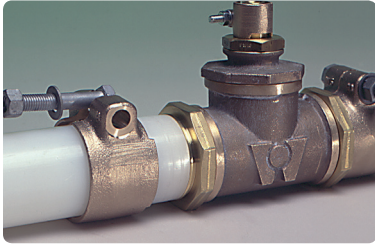

Figure 4-31: Push Outer Sleeve to Stop Support



Important: Lubricate the bolt threads and washer with suitable low friction lubrication (MoS₂) before tightening.

- Tighten the WIPEX fitting slowly by hand to avoid thread problems when assembling acid-resistant stainless steel bolts in a screw joint. If using a tightening machine, only use a low number of revolutions. Use open-ended or ring spanners and slowly tighten until the pads of the clamping sleeve are in contact with one another (see Figure 4-32).

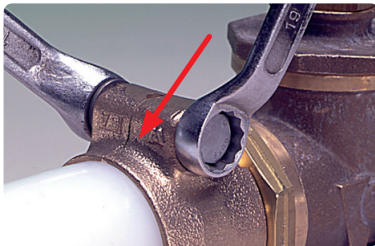

Figure 4-32: Tighten the Fitting



Caution: If the pads do not come in contact, wait at least 30 minutes and tighten until the pads are in contact with one another (see Figure 4-33).

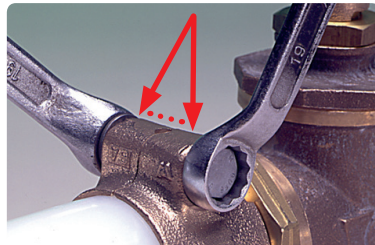

Figure 4-33: Grip and Seal Between Fitting and Pipe

- Perform tightness testing according to current norms prior to using the system. If standards for tightness testing are not available, refer to the following instructions.
 - Vent all air from the system and apply 1½ times the normal operating pressure.
 - Maintain this pressure for 30 minutes and visually inspect the joints.
 - Quickly drain off water until the pressure falls to half the operating pressure, and close the drain valve.
 - If the pressure rises to a constant level higher than half the normal operating pressure, the system is tight.
 - Maintain this pressure for 90 minutes and visually inspect the fittings during this time. A drop in pressure indicates leakage in the system.

Specifications and Profiles

| | |
|-------------------------------------|-------------------|
| Maximum Operating Pressure: | 87 psi at 203°F |
| Pre-insulated Pipe Sizes Supported: | 1" to 4" |
| Pressure Class: | 87 psi to 145 psi |

Table 4-4: Specifications

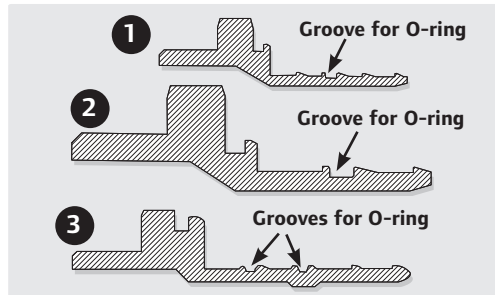

Figure 4-34: Grooves for O-ring Placement

| Style | Profile Dimensions | Pressure Class |
|-------|--------------------|-----------------|
| 1 | 2½" to 4" | 87 psi at 203°F |
| 2 | 1" to 2" | 87 psi at 203°F |

Table 4-5: Pressure Class of Profiles

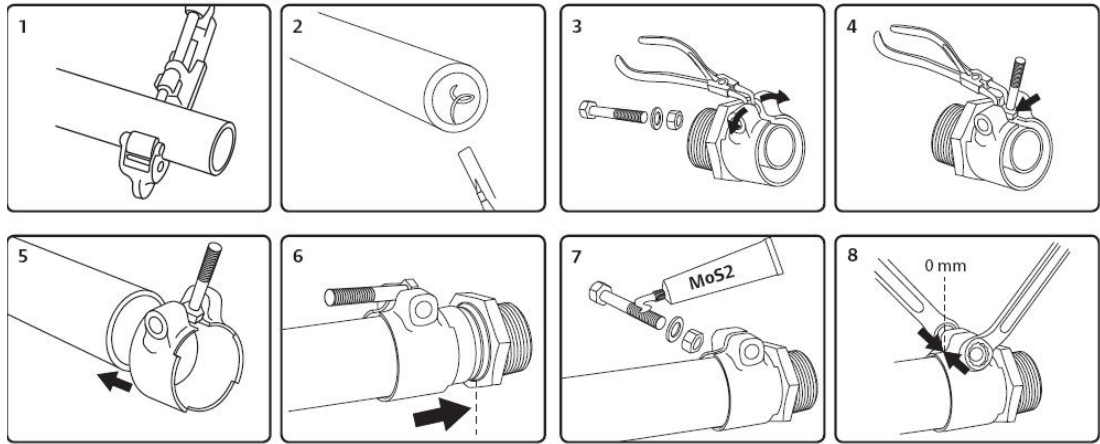

Figure 4-35: Visual Summary of Installation Steps

Installing the Connection Vault

Tools Required

- Soft-flame torch
- Abrasive cloth
- Hand saw
- Mastic tape

Instructions

Use the following steps to install the Connection Vault.

1. The unique design of the Connection Vault makes it perfect for burial underground. Locate an area that allows easy access in the event of future excavation (modifications or inspection). Position the Connection Vault in the trench to achieve proper pipe alignment.

Note: If being installed in area of high water table, install and secure a concrete anchoring pad below the vault.

2. Using a hand saw, cut away end of the outlet suitable for the outside diameter of the Ecoflex jacket — only cut what is necessary to ensure a full-sized opening — typically $\frac{1}{2}$ " (see **Figure 4-37**).

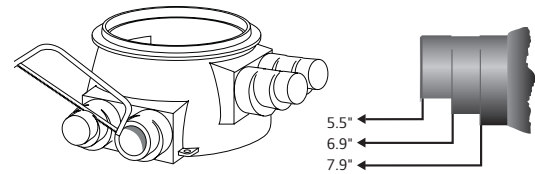

Figure 4-37: Cut the Outlet

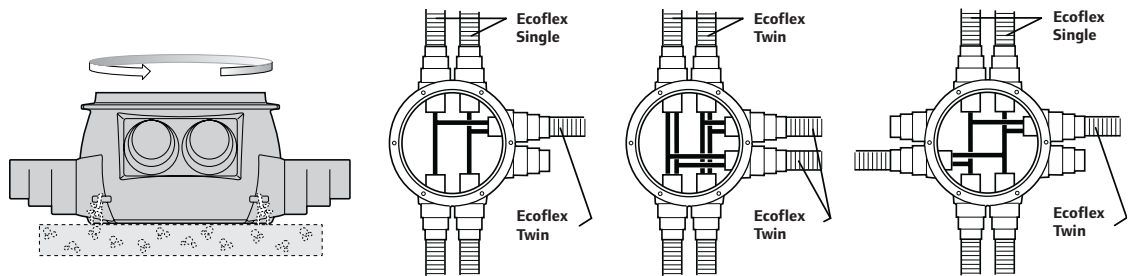

Figure 4-36: Locate and Position the Connection Vault

3. Install the Rubber End Cap and Male Adapter Fitting before installing into the Connection Vault. Slide the Connection Vault Heat Shrink Sleeve over the pipe before sliding into outlet opening.

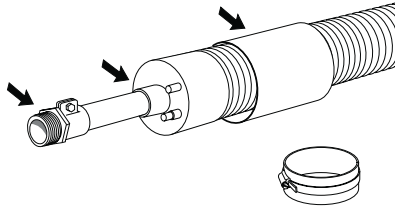

Figure 4-38: Prepare the Pipe

4. Insert all pipes into the Connection Vault and make all service pipe connections, as shown in Figure 4-39; then perform a pressure test.

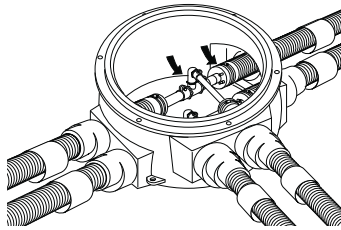

Figure 4-39: Final Connections

Important: Pressure test the connections before proceeding.

5. Using an abrasive cloth, lightly sand the surface of the Connection Vault and corresponding pipe jacket to provide a rough surface for proper adhering.

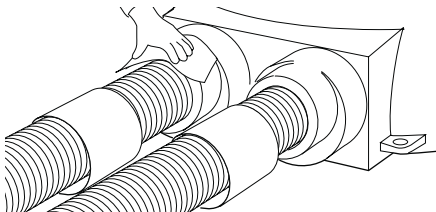

Figure 4-40: Lightly Sand Connection Vault Surface

6. Apply mastic tape to the pipe 2" from the vault outlet. Using a soft-flame torch, preheat the vault outlet, being careful not to overheat.

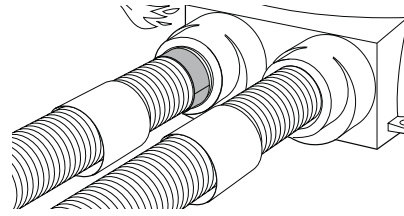

Figure 4-41: Apply Mastic Tape



Caution: Keep flame in constant motion. Do not overheat.

7. Remove the protective backing from the Heat Shrink Sleeve and slide over the Wall Sleeve at least 4". Using a soft-flame torch, evenly apply heat to the heat shrink sleeve only on the Connection Vault outlet.

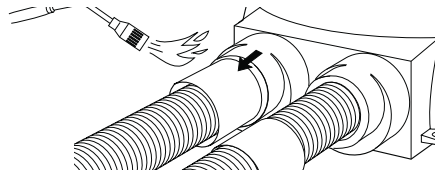

Figure 4-42: Secure Heat Shrink Sleeve

8. Wait five minutes for the seal to cool. Secure Heat Shrink Seal to pipe jacket following the same procedures as in Step 7.

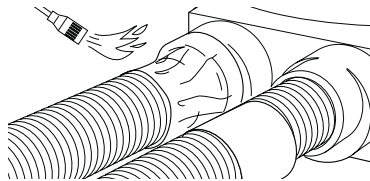

Figure 4-43: Heat Shrink Seal



Caution: Keep flame in constant motion. Do not overheat.

9. Clean the rubber lid gasket, ensuring it is free from dirt and debris. Secure lid. Manually place backfill around the Connection Vault. Be careful not to damage the Heat Shrink Seal connections. Verify that the Connection Vault remains in position during the backfill. Compact the soil in layers of 8" to 12". Do not use mechanical compaction directly over the Connection Vault lid.

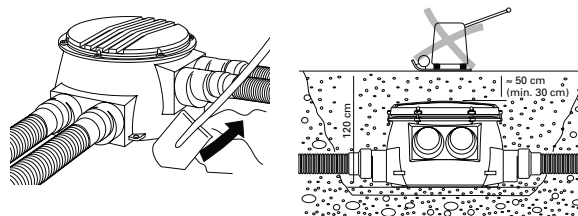

Figure 4-44: Protecting the Connection Vault

Note: Protect the Connection Vault from traffic loads with a concrete slab. If a load-distributing slab is not used, a Connection Vault covered with 20" of sand will withstand an occasional momentary load of 6,600 lbs. (e.g., a tractor passing over). The maximum stationary load permitted is 1,100 lbs. (e.g., a car parked above).

For a description of these products, refer to **Section 2: Products and Hardware**.

Tools Required

- Hand saw
- Tape measure
- Chamfering tool
- Sharp razor knife
- Permanent ink marker
- Sharp scissors
- Torque wrench
- Pipe lubricant
- Clean rag

Installing with Insulation Kits

Uponor features a variety of insulation kits designed for specific applications:

- Straight Insulation Kit
- Tee Insulation Kit
- 90-degree Insulation Kit
- H-insulation Kit

The following figure shows examples of insulation kits for an H-connection and a Tee-connection. Refer to **Table 4-6** for dimensions.

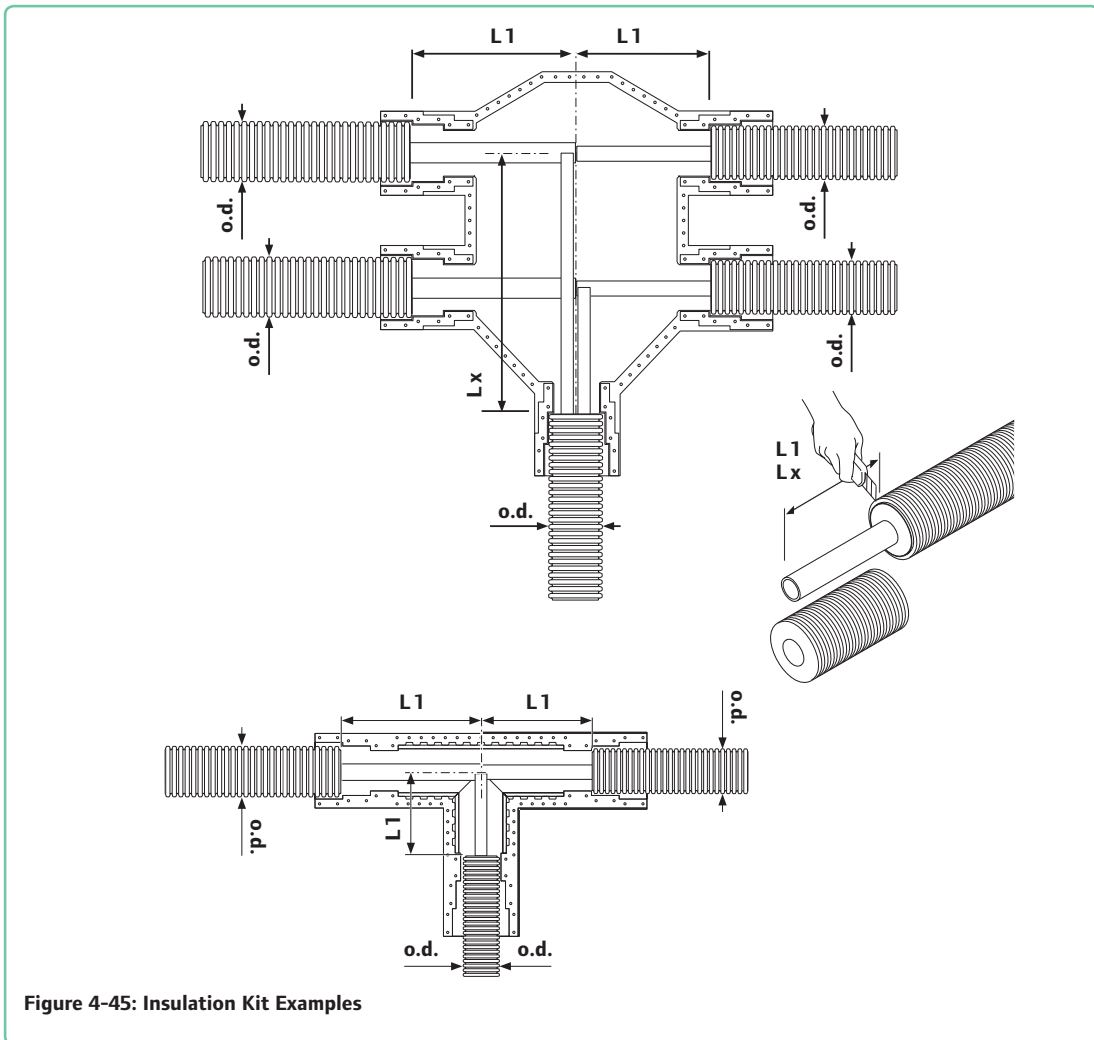

Figure 4-45: Insulation Kit Examples

| Outside Diameter (O.D.) | L1 | Lx |
|-------------------------|-----|-----|
| 5.5" | 12" | 35" |
| 6.9" | 16" | 39" |
| 7.9" | 20" | 43" |

Table 4-6: Pipe Diameter and Cut Measurements

Instructions

The following outlines the basic steps for pipe

installation using insulation kits. It is helpful to become familiar with the previous installation instructions for the Rubber End Cap and the WIPEX Fittings or ProPEX Fittings when following these instructions for connecting pipe using insulation kits.

Uponor offers several types of insulation kits depending on specific application requirements. Refer to **Figure 4-46** for configurations of these insulation kits.

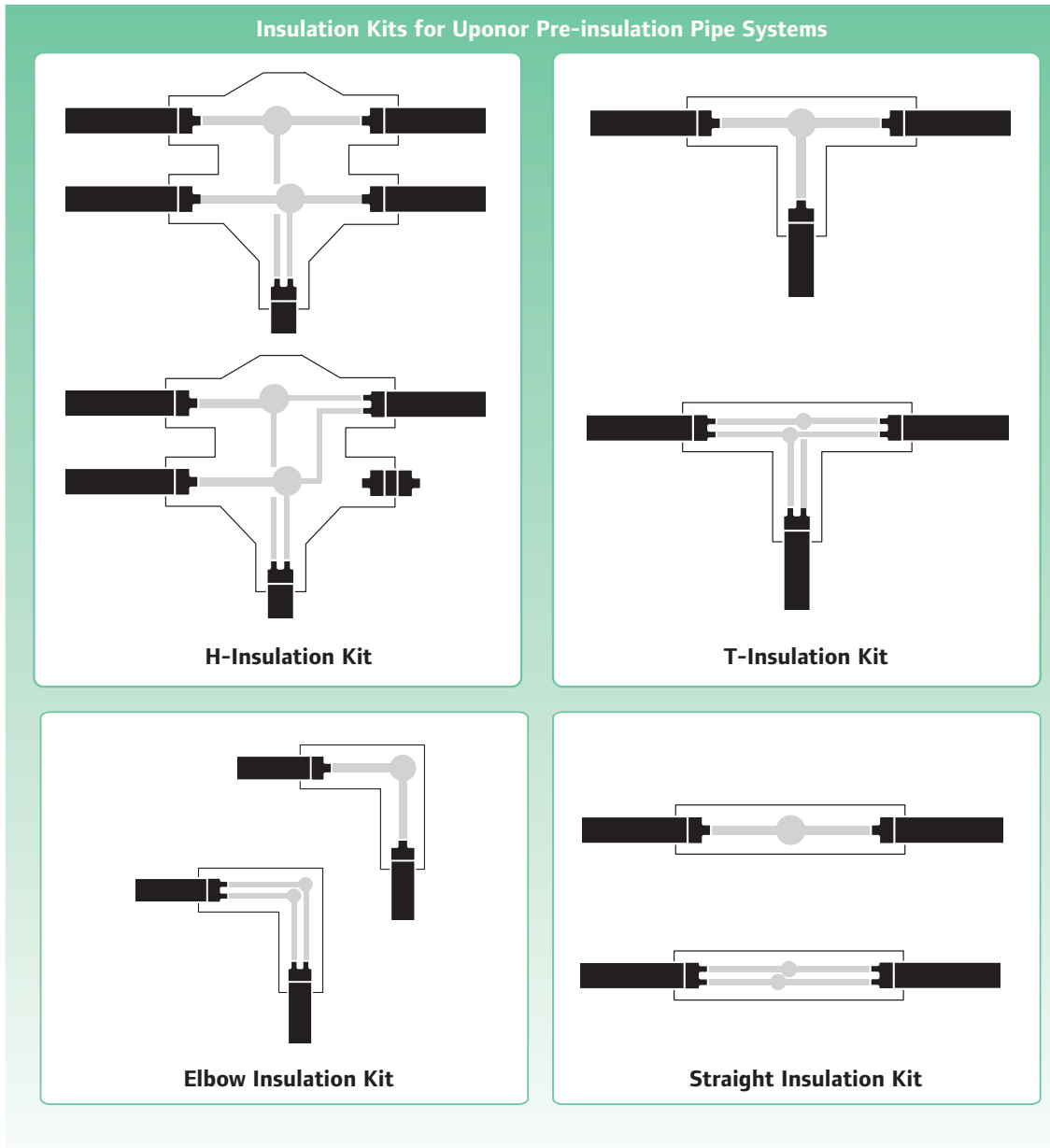
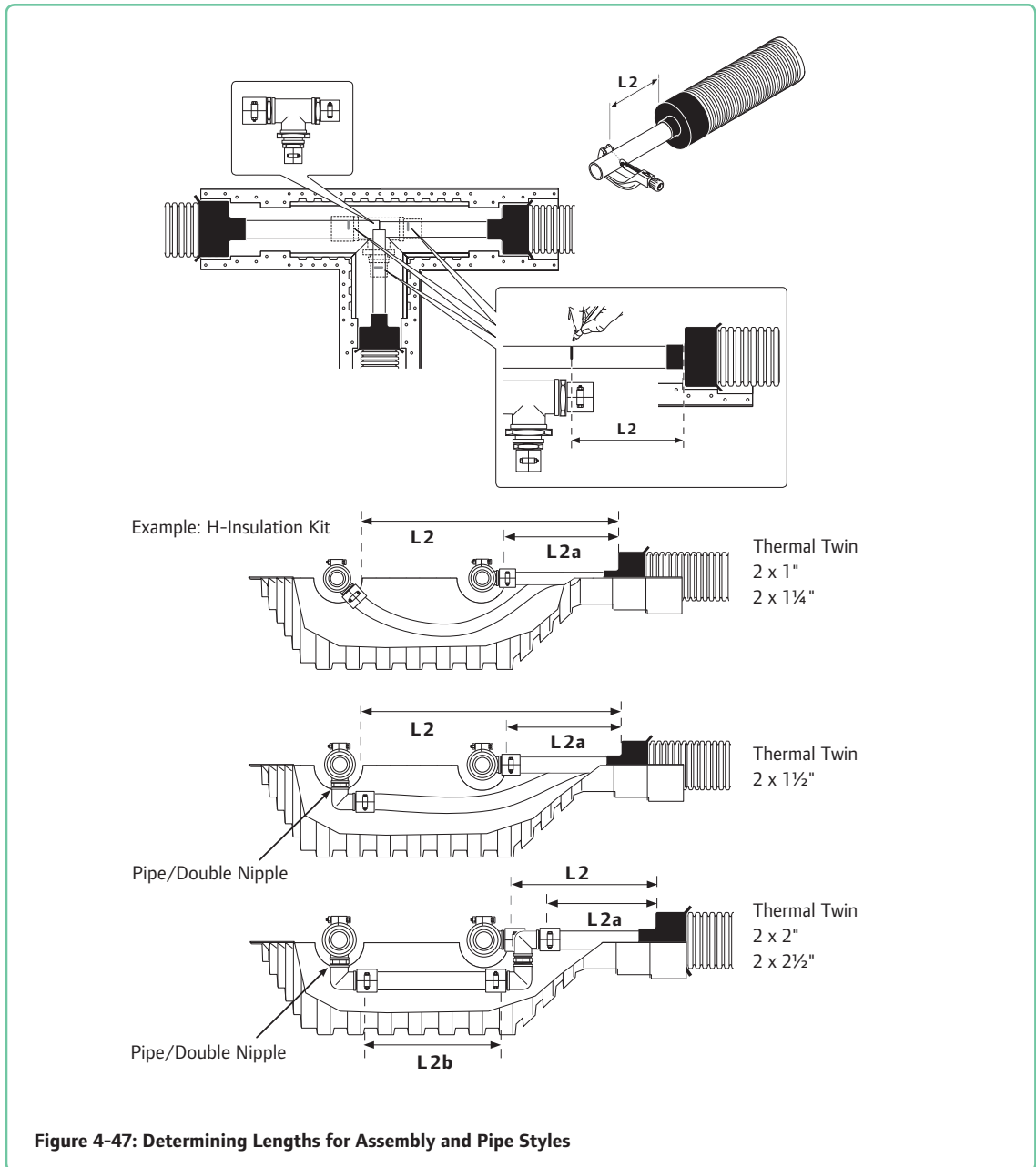

Figure 4-46: Insulation Kit Configurations

1. Determine pipe lengths for the pipe assembly, measure the amount of pipe needed for the assembly. Refer to **Figure 4-47**.



2. Remove casing and insulation. Peel off the casing and remove the required amount of insulation (taking into account the length of the End Cap). Only peel off what is absolutely required in order to connect the pipe.
3. Install Rubber End Cap. Refer to **Installing the Ecoflex EPDM Rubber End Cap** section on **page 29**.



Important: Don't apply the stainless steel clamp when installing into an insulation kit.

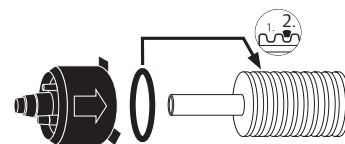

Figure 4-48: Install Rubber End Cap

4. Assemble the connection. See **Figure 4-49** for example of a Tee-connection and refer to **Installing WIPEX Fittings on page 31**.

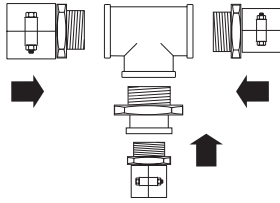

Figure 4-49: Assemble the Connection

5. Join the pipes with fittings. Refer to **Installing WIPEX Fittings on page 31** for details.
6. Pressure test the system. **Table 4-4** and **Table 4-5** on **page 33** lists specifications and local codes for pressure testing.

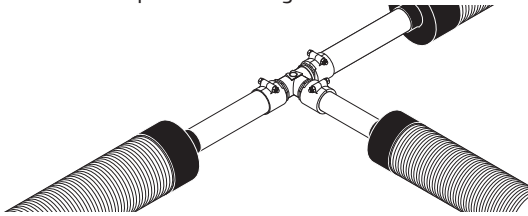

Figure 4-50: Pressure Test

7. Apply sealant compound in the bottom of the insulation shell. **Figure 4-51** illustrates a Tee-connection.

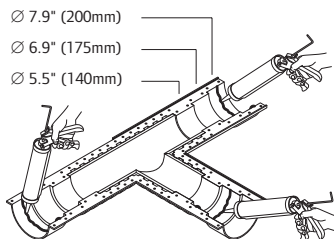

Figure 4-51: Apply Sealant

8. Place the connected pipes into the insulation shell as shown (**Figure 4-52**).

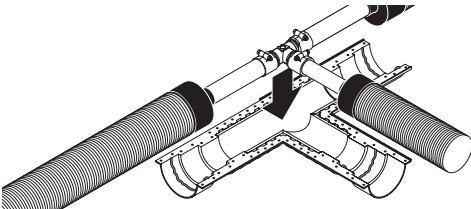

Figure 4-52: Placing the Pipes

9. Apply sealant compound to end caps and shell as shown (**Figure 4-53**).

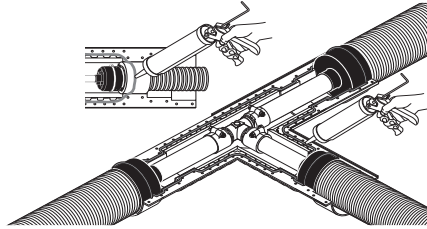

Figure 4-53: Sealant Compound

10. Place the top part of the insulation shell into place over the piping.

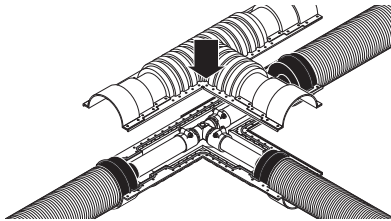

Figure 4-54: Top Shell of Insulation Kit

11. Tighten all bolts and screws of the outer shell, and hammer in all rivets.

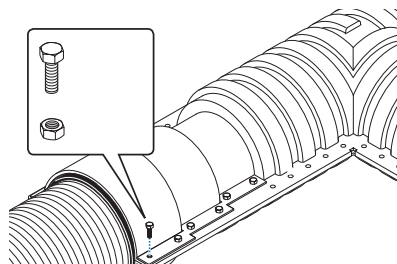

Figure 4-55: Fastening the Outer Shell

12. Tighten all bolts and screws and hammer rivets on the inner shell as shown.

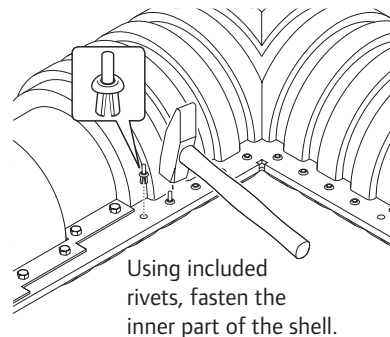

Figure 4-56: Fastening the Inner Shell

Compression Wall Seal Installation Methods

This section illustrates the various Wall Seal installation applications. Typical examples show procedures for use. Applications vary depending on installation design requirements.

Tools Required

Tools and components needed for this installation include the following.

- Compression Wall Seal — pressure waterproof and included hardware (nuts, bolts, etc.)
- Epoxy Resin
- Wall Sleeve (optional)
- Protective End Caps or plastic covering
- Pipe clamp (optional)
- Cutting tools
- Drill (optional)

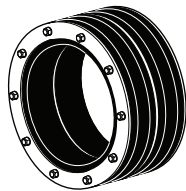

Figure 4-57: Wall Seal, Pressure Waterproof up to 7.0 psi (0.5 bar)

Use the Uponor Wall Seal to provide sealing against high-pressure water. The installer inserts the Wall Seal into the core hole or casing pipe on the outside wall. When installing, insert Wall Seal with nuts of the seal facing towards the inside wall or basement side.

You can use the Compression Wall Seal with the Wall Sleeve or alone in applications where a field core drill is preferred. Refer to **Table 4-7: Installation Parameters (Core Hole)** on page 41 for the required core drill size.

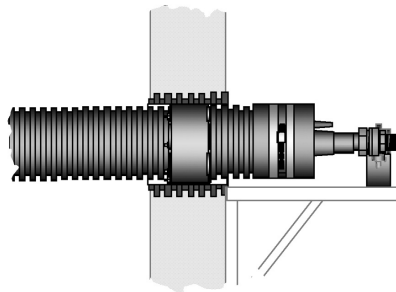

Figure 4-58: Wall Sleeve, Pressure Waterproof up to 7.0 psi (0.5 bar)

For new concrete walls, use the Wall Sleeve with the Compression Wall Seal to simplify the installation process. It is easy to cut for proper fit within concrete forms. The Wall Sleeve offers an extra convenience for the installer. The Wall Sleeve provides a tight seal under pressurized water — easy to cast when pouring new cement walls.

Wall Sleeve Installation Example

If you are installing piping without bends so that it lies straight, all you need is the Wall Seal. Tension-free installations do not require a supplementary set.

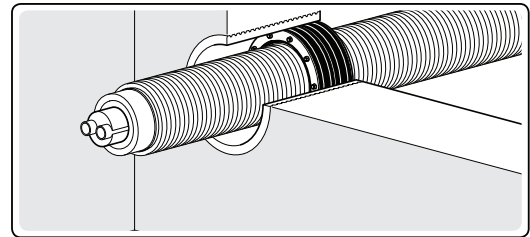

Figure 4-59: Tension-free Installation

Core Holes in Water-impermeable Concrete

At the designated area, bore through the wall with an appropriate cement drill.

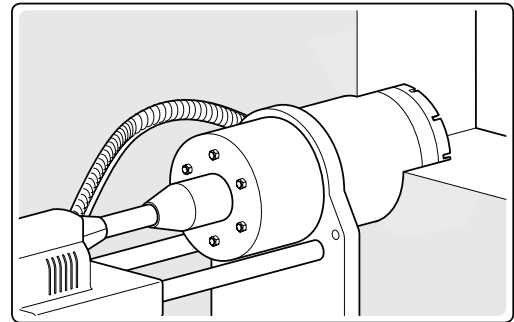

Figure 4-60: Drilling the Core Hole

After drilling, protect the bore wall with Epoxy Resin. Wearing protective gloves, cover the inside cut of the core hole according to the directions on the resin container.

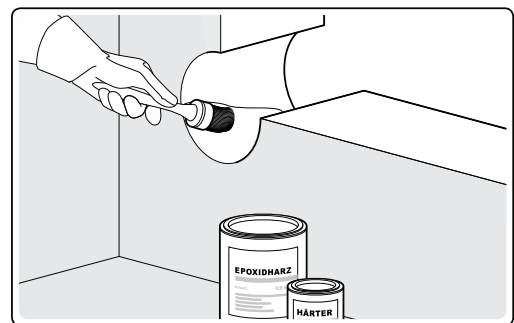

Figure 4-61: Protect the Bore Wall with Epoxy Resin

Protect the bore from contamination and moisture during the unfinished phase of the installation. Tape plastic over the core hole on both sides of the wall, or insert protective end caps (supplied by installer) onto both sides of the core hole as shown in **Figure 4-62**.

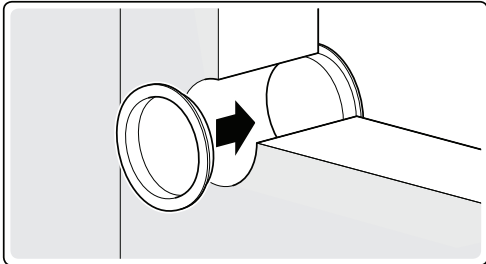

Figure 4-62: Protect the Bore During Installation

| Uponor Ecoflex Jacket Pipe (inches) | Core Hole (inches) |
|-------------------------------------|--------------------|
| 5.5" | 8.0" |
| 6.9" | 10" |
| 7.9" | 12" |

Table 4-7: Installation Parameters (Core Hole)

Wall Sleeve Installation

If pouring new walls, you can cast the Uponor Wall Sleeve at the same time. The special pipe casing in combination with the Wall Seal ensures a tight seal under pressurized water.

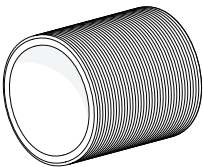

Figure 4-63: Wall Sleeve

You can install the Wall Sleeve either flush with the casing or projected out from the wall casing (see **Figures 4-64** and **4-65**).

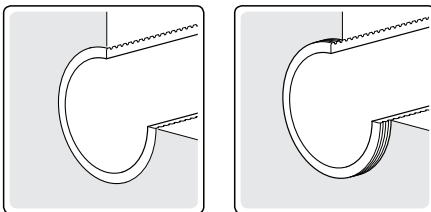

Figure 4-64 and 4-65: Flush with Casing, Projected from Casing

You can fasten a steel framework to the Wall Sleeve so that it is either flush with or protruding from welded joints or with a pipe clamp (supplied by the installer).

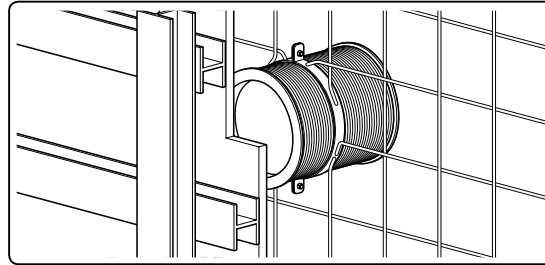
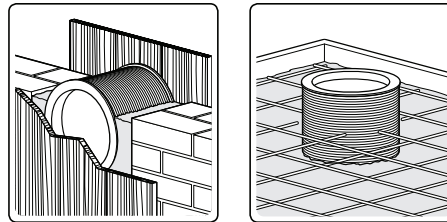

Figure 4-66: Fasten in Steel Framework

You can also build the Wall Sleeve directly into walls or install them into floors and ceilings as shown in **Figure 4-67** and **4-68**.



Figures 4-67 and 4-68: Built into a Wall, Installing into a Floor or Ceiling

When installing Wall Sleeves, ensure to compact the cement around the seams of the pipe casing thoroughly as shown.

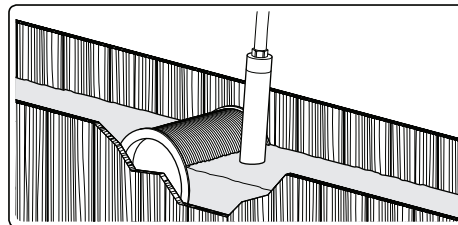

Figure 4-69: Compacting the Cement

Protect the bore openings from contamination and moisture during the unfinished phase by inserting protective end caps or securely covering (taping) the bore with plastic.

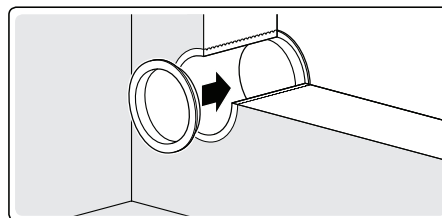

Figure 4-70: Protect Core Openings

Table 4-8 shows the required size of the Wall Sleeve used for specific sizes of Uponor Ecoflex Jacket Pipe.

| Uponor Ecoflex Jacket Pipe (inches) | Wall Sleeve (inches) |
|-------------------------------------|----------------------|
| 5.5" | 8.0" |
| 6.9" | 10.0" |
| 7.9" | 12.0" |

Table 4-8: Installation Parameters (Wall Sleeve)

Installing the Wall Seal into the Core Hole or Wall Sleeve

Note: The following illustrations show the basement on the left side of the wall.

Insert the Wall Seal flush with the end of the core hole on the side of the outside wall (the water side) — nuts face toward the inside walls (the basement).

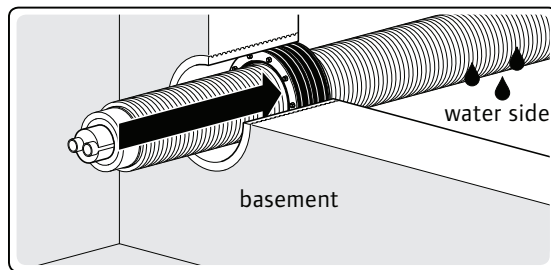

Figure 4-71: Wall Seal Installed Flush with Outside Wall Opening

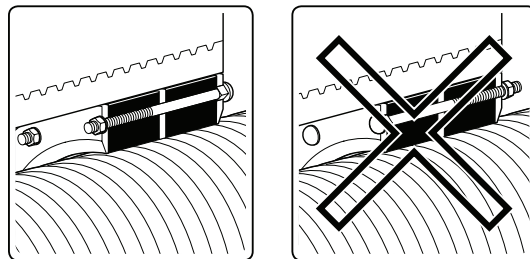

Figure 4-72: Correct vs. Incorrect Wall Seal Installations



Caution: Make sure the nuts are facing toward the basement when inserting the Wall Seal.

Install the Wall Seal pipe at right angles to the pipe as shown.

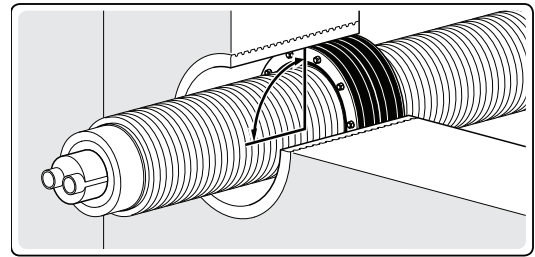

Figure 4-73: Install Wall Seal Pipe at Right Angles to Pipe

When tightening to the maximum torque, keep the following in mind.

- During final assembly, successively tighten each nut with a torque-wrench clockwise until the maximum torque M_{max} is reached ($M_{max} = 5 \text{ Nm (M6)/3.7 lbf}\cdot\text{ft}$; $M_{max} = 8 \text{ Nm (M8)/5.9 lbf}\cdot\text{ft}$).
- Tighten the nuts several times.
- Repeat this procedure after two hours.
- To ensure no damage to the Ecoflex jacket, tighten the nuts of the Uponor Wall Seal until the rubber seal wraps around the Ecoflex jacket pipe and the core hole, or if used, the Wall Sleeve. **Figure 4-72** illustrates the correct way vs. the incorrect way of installing the Wall Seal.
- The house lead-ins are neither fixed points nor supports and serve solely to provide an elastic seal for the jacket pipes of Ecoflex.
- The installer can gently turn the Ecoflex jacket pipes in an axial motion.
- Before filling in the pipe trench, place compressed, stoneless sand under the Ecoflex piping so that no additional stress can affect the seal.

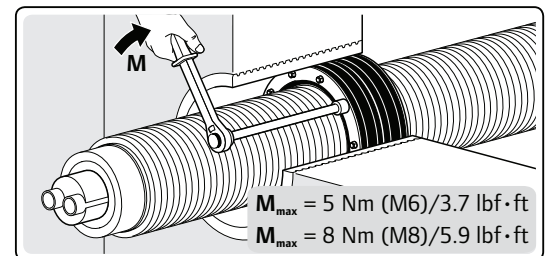

Figure 4-74: Tighten to Maximum Torque

Jacket Repair – Procedures for the Poly Tape Method

Tools Required

- Uponor Shrinkable Tape (1018378)
- Sealing caulk or sealing mastic
- Sharp razor knife • Brush (scrub/utility)
- Clean rag • Torch (medium flame)
- Soap (non-caustic)

Note: Do not attempt to repair a hole larger than 9 square inches. If severely damaged, contact Uponor.

1. Repair holes immediately. It is best to repair jacket damage outside of the trench in a clean, dry environment as soon as possible.
2. Using a sharp razor knife, trim all sharp edges and protruding plastic from the damaged area.

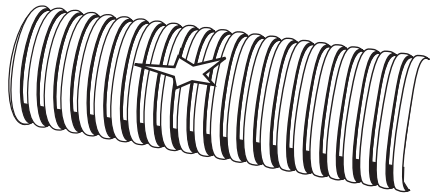

Figure 4-75: Trimming

3. Prepare the surface by loosening and scrubbing off debris with a dry scrub brush. Using a dry rag, clean area of all foreign debris in the full circumference of the area to be repaired (at least 6" on both sides of the damaged area). Uponor recommends using soap or non-caustic cleanser to ensure the damaged area is completely clean prior to repair. Ensure the area is thoroughly dry after cleaning.

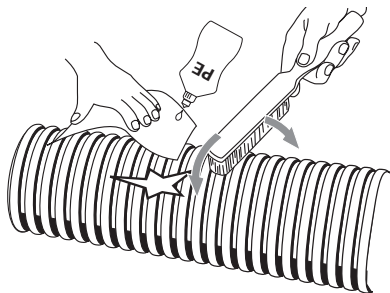

Figure 4-76: Preparation and Cleaning

4. Torch the area with a medium flame, using continuous movement over the entire area to ensure an even heat. Do not apply direct flame to the tubing. Keep flame 1 to 2" away from pipe jacket. The temperature of the pipe jacket should not exceed 158°F (70°C).

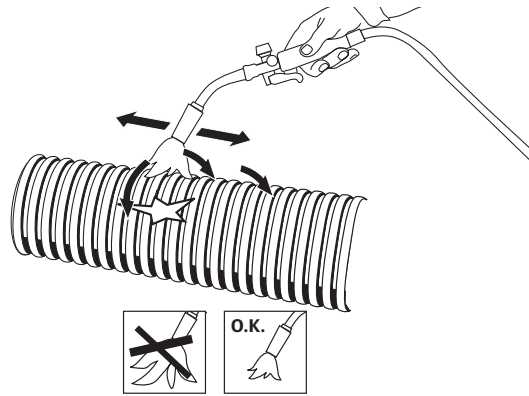

Figure 4-77: Applying Heat to Tubing

5. Use Uponor Shrinkable Tape (1018378). Position the repair tape directly over the damaged area. Ensure that the repair tape covers the area completely and extends beyond the damaged area on both sides by at least 6" (15 cm).

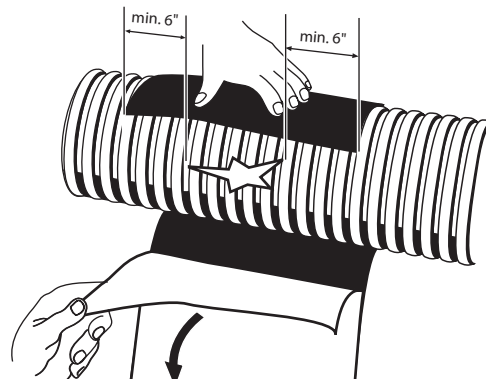

Figure 4-78: Positioning Repair Tape

6. Apply gentle heat with continuous movement to the inside of the repair tape using a medium torch flame — the temperature of the repair tape should not exceed 158°F (70°C).

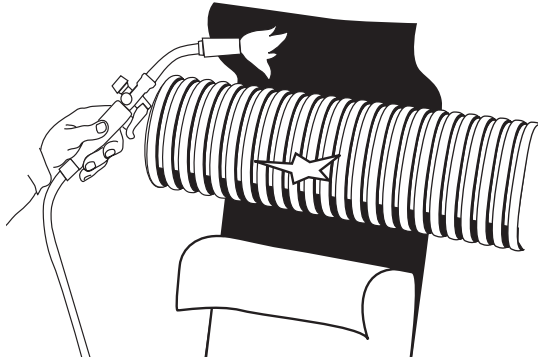

Figure 4-79: Torch Inside of Repair Tape

7. Wrap the repair tape around the jacket circumference continuously to 6" (15 cm) in one direction. Continue taping over the damaged area to 6" (15 cm) in the opposite direction. To seal the repair, apply heat over the installed tape using a medium torch flame. Remember to use continuous movements with the torch and never apply direct flame to the surface of the tape or pipe jacket. The temperature of the surface should not exceed 158°F (70°C).

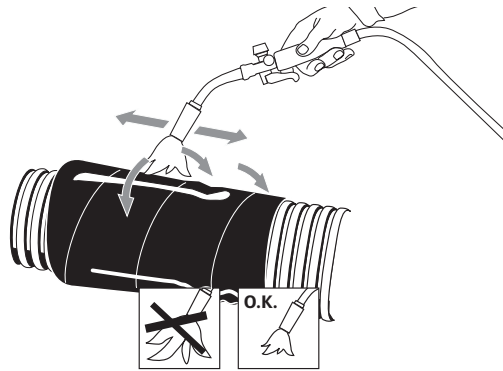

Figure 4-79: Torch Inside of Repair Tape

8. Backfill by hand. Fill and compact the trench around repaired area manually, taking care not to damage the repair.

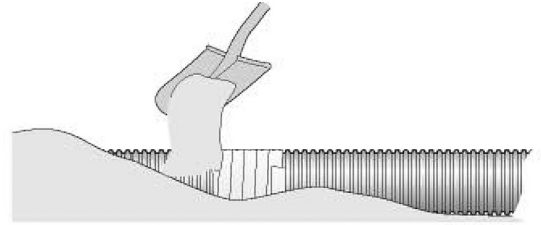

Figure 4-80: Backfilling

Section 5:

Appendix A — Ecoflex Pressure Loss Charts

HDPE Piping

The following chart shows pressure loss per 100 feet at 160°F (71°C) for HDPE pipe sizes from 3/4" through 4" at a velocity ranging from 1 ft./second through 25 ft./second. General correction factors are listed in

the tables following the chart in this section. Refer to **Table 5-1** for correction factors for different temperatures. Refer to **Table 5-2** for correction factors for using glycol mix.

Pressure Loss and Velocity, HDPE Pipes

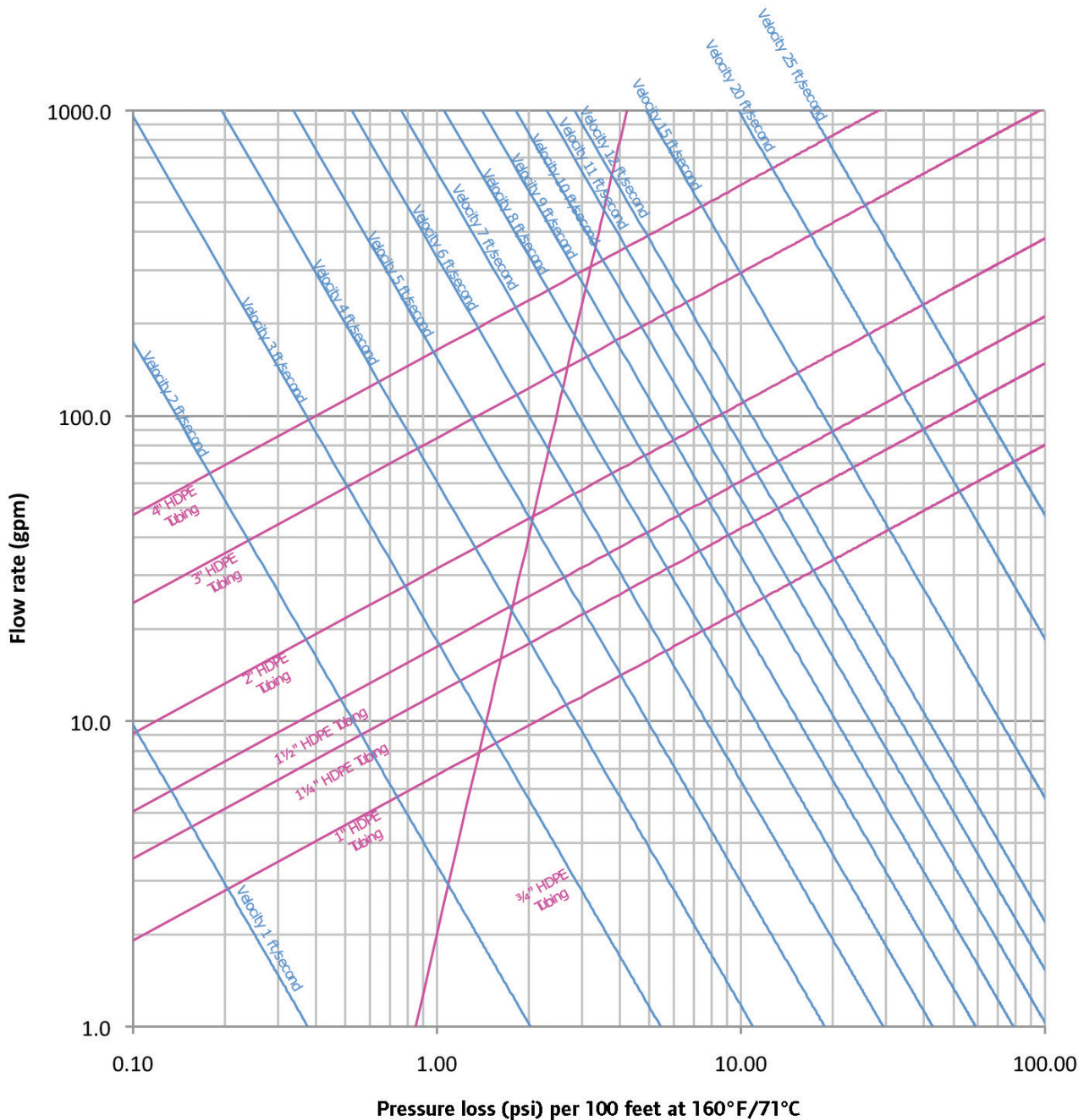

| General Correction Factors Correction factors for different temperatures (Multiply head loss by factor) | | | | | | | | |
|--|----------------|----------------|----------------|----------------|----------------|----------------|---------------|---------------|
| Temp | 200°F/ 93°C | 180°F/ 82°C | 160°F/ 71°C | 140°F/ 60°C | 120°F/ 49°C | 100°F/ 38°C | 80°F/ 27°C | 60°F/ 16°C |
| Factor | 0.96 | 0.98 | 1.00 | 1.02 | 1.05 | 1.10 | 1.14 | 1.20 |

Table 5-1: Temperature Correction Factors

| Correction Factors for Using Glycol Mix (Multiply head loss by factor) | | | |
|---|------|------|-----|
| % Glycol | 30% | 40% | 50% |
| Factor | 1.24 | 1.33 | 1.4 |

Table 5-2: Glycol Mix Correction Factors

PEX Piping

The following chart shows pressure loss per 100 feet at 160°F (71°C) for PEX tubing sizes from 1" through 4" at a velocity ranging from 1 ft./second through 25 ft./second. General correction factors are listed

in the tables following the chart in this section. Refer to **Table 5-3** for correction factors for different temperatures. Refer to **Table 5-4** for correction factors for using glycol mix.

Pressure Loss and Velocity, PEX Tubing

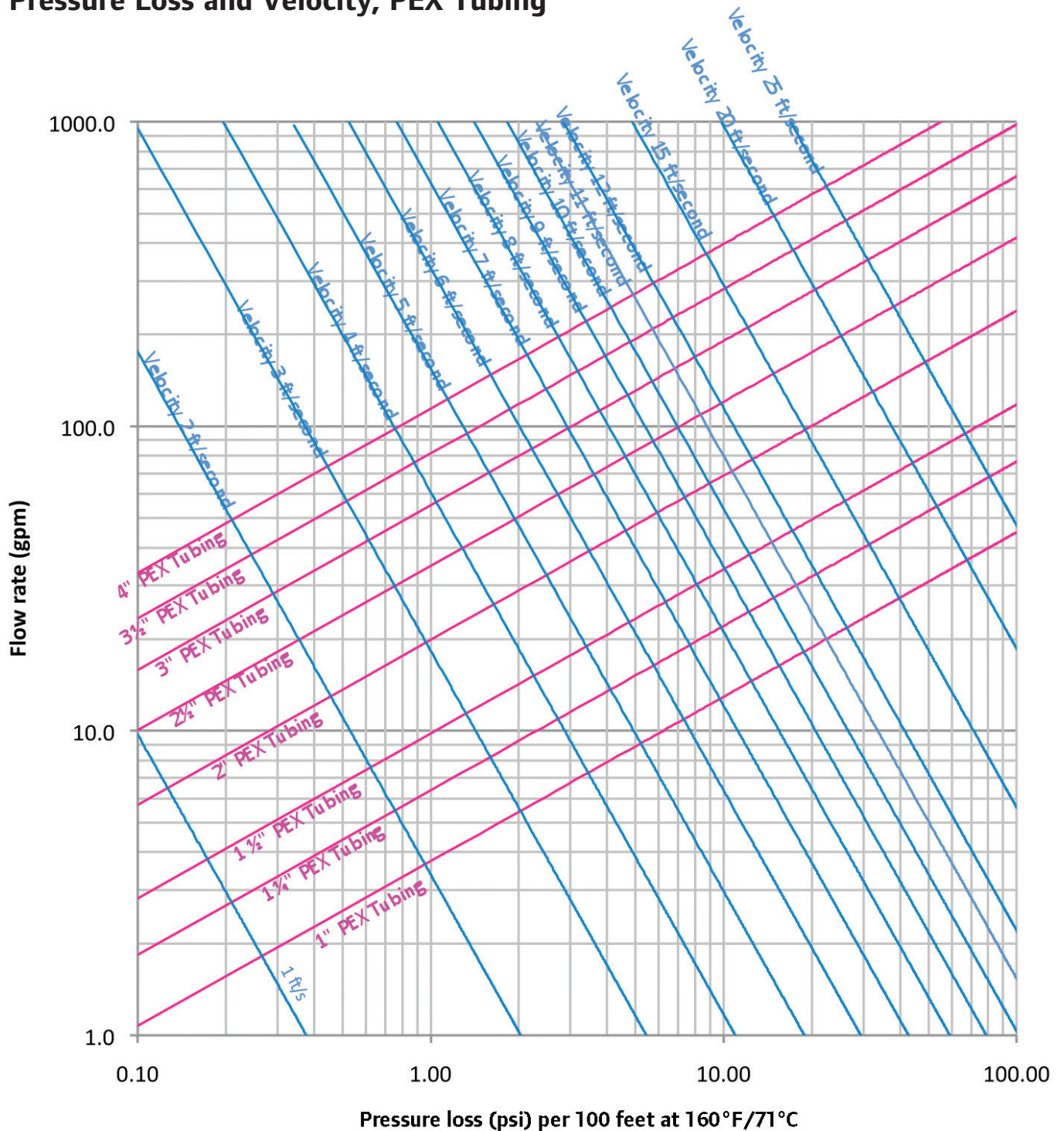

| General Correction Factors Correction factors for different temperatures (Multiply head loss by factor) | | | | | | | | |
|--|----------------|----------------|----------------|----------------|----------------|----------------|---------------|---------------|
| Temp | 200°F/ 93°C | 180°F/ 82°C | 160°F/ 71°C | 140°F/ 60°C | 120°F/ 49°C | 100°F/ 38°C | 80°F/ 27°C | 60°F/ 16°C |
| Factor | 0.96 | 0.98 | 1.00 | 1.02 | 1.05 | 1.10 | 1.14 | 1.20 |

Table 5-3: Temperature Correction Factors

| Correction Factors for Using Glycol Mix (Multiply head loss by factor) | | | |
|---|------|------|------|
| % Glycol | 30% | 40% | 50% |
| Factor | 1.24 | 1.33 | 1.40 |

Table 5-4: Glycol Mix Correction Factors

Section 6:

Appendix B — Energy/Heat Loss Chart

Uponor provides charts in this section to our customers as general guidelines for calculating energy loss expected with the use of different pre-insulated piping. For precise calculations, we recommend consulting with a professional engineer as various factors can affect energy or heat loss.

The following parameters determine energy-loss calculations:

- Fluid supply temperature of 180°F with 20°F ΔT (170°F average temperature)
- Soil K factor = 12
- Depth from surface = 24"
- Calculation variable = ambient soil temperature

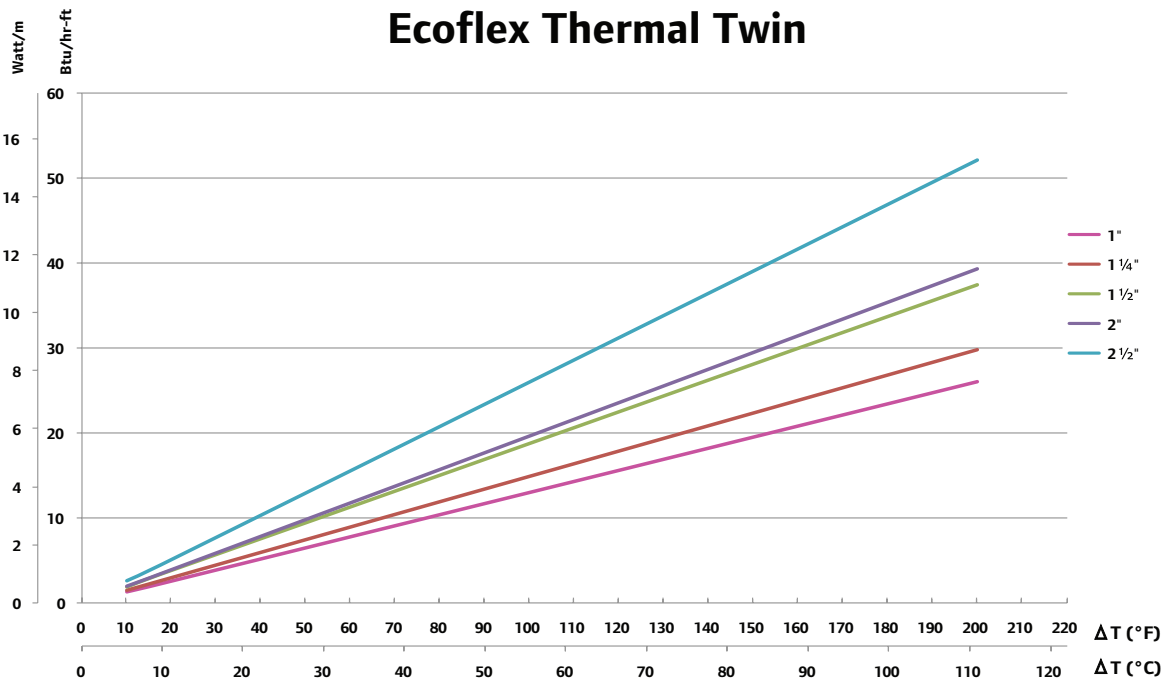

Caution: Energy losses can vary dramatically based on soil temperature, moisture content and soil type. Uponor provides these values as a courtesy to our customers to offer a general understanding of the estimated energy losses one may expect. If you require precise calculations, we recommend you consult a professional engineer for your particular project.

Ecoflex Thermal Single

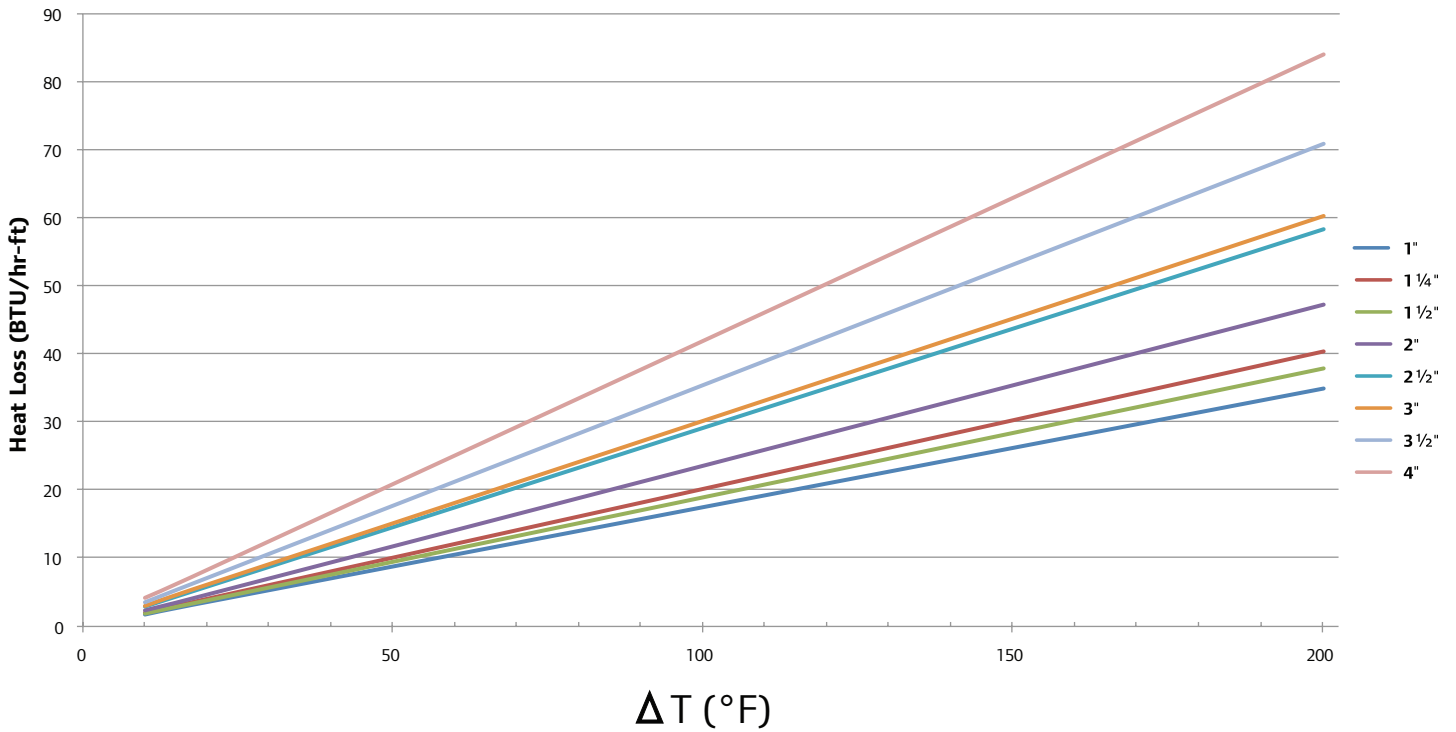

The following parameters determine energy-loss calculations.

- Fluid supply temperature of 180°F with 20°F ΔT (170°F average temperature)
- Soil K factor = 12
- Depth from surface = 24"
- Calculation variable = ambient soil temperature



Caution: Energy losses can vary dramatically based on soil temperature, moisture content and soil type. Uponor provides these values as a courtesy to our customers to offer a general understanding of the estimated energy losses one may expect. If you require precise calculations, we recommend you consult a professional engineer for your particular project.

Ecoflex Potable HDPE

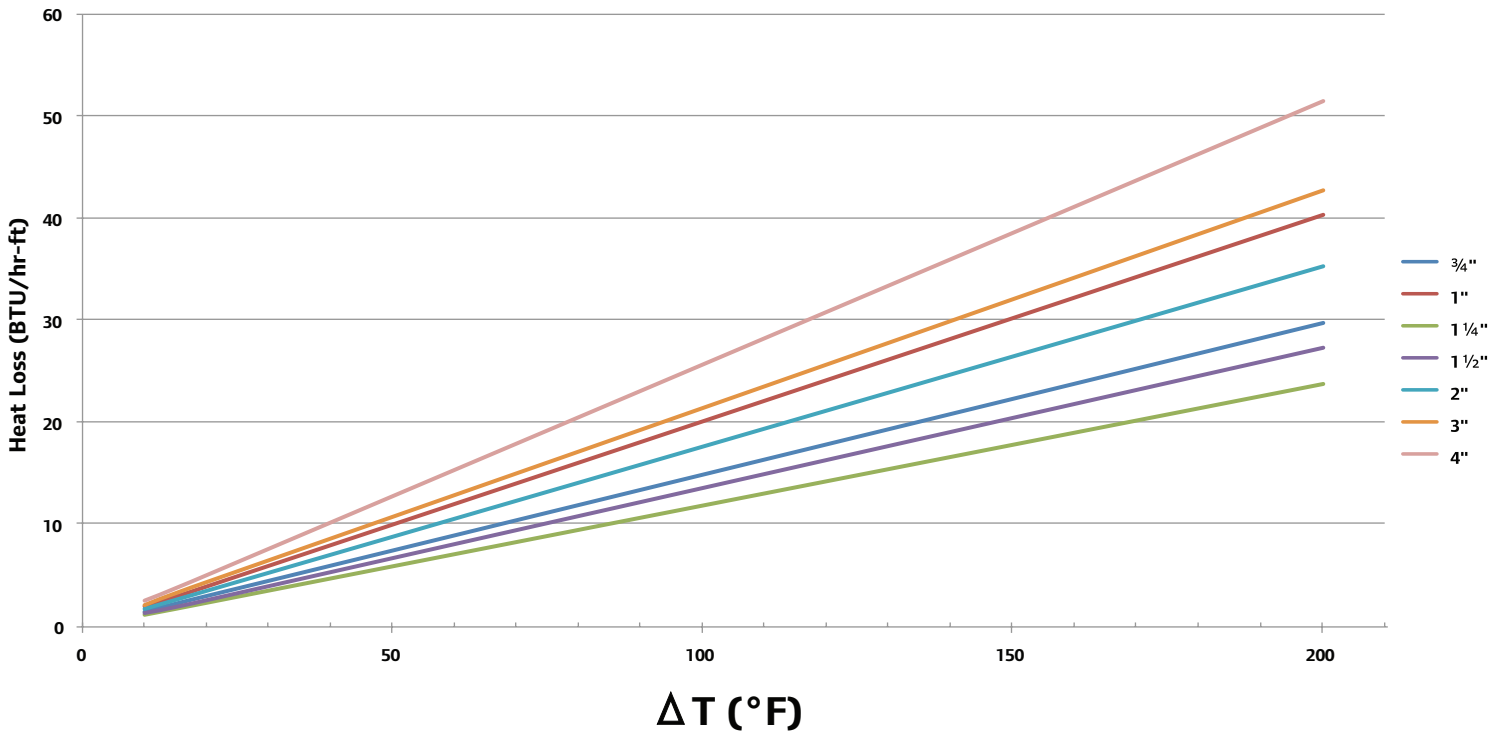

The following parameters determine energy-loss calculations:

- Fluid supply temperature of 180°F with 20°F ΔT (170°F average temperature)
- Soil K factor = 12
- Depth from surface = 24"
- Calculation variable = ambient soil temperature



Caution: Energy losses can vary dramatically based on soil temperature, moisture content and soil type. Uponor provides these values as a courtesy to our customers to offer a general understanding of the estimated energy losses one may expect. If you require precise calculations, we recommend you consult a professional engineer for your particular project.

Section 7: Appendix C — Detailed Drawings

Trench Detail — One Pipe and Multiple Pipes

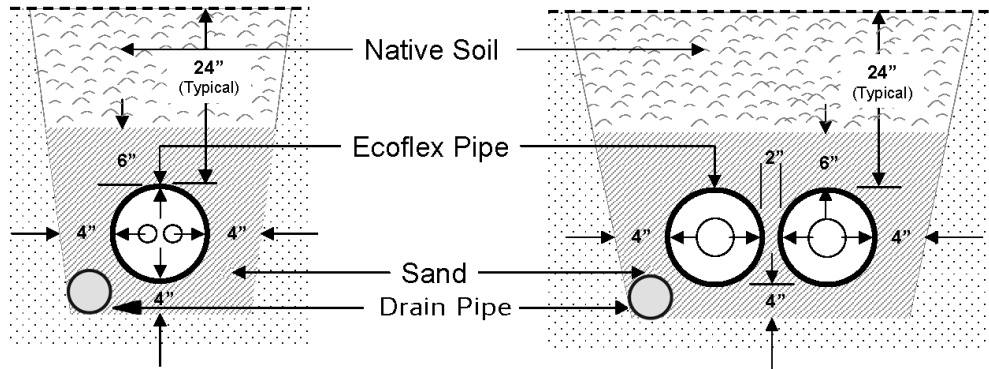

Trench Detail — Ecoflex Pipes Above Other Pipe Systems

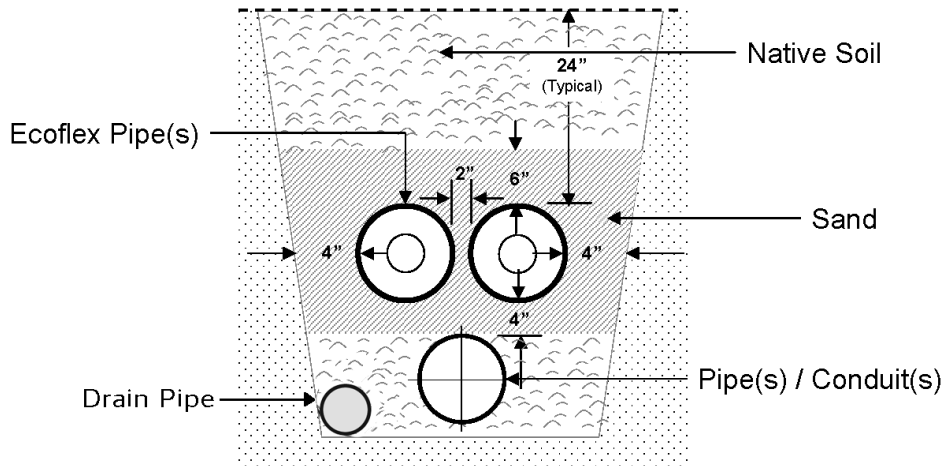

Slab-on-grade Installation — Outside Wall Attachment

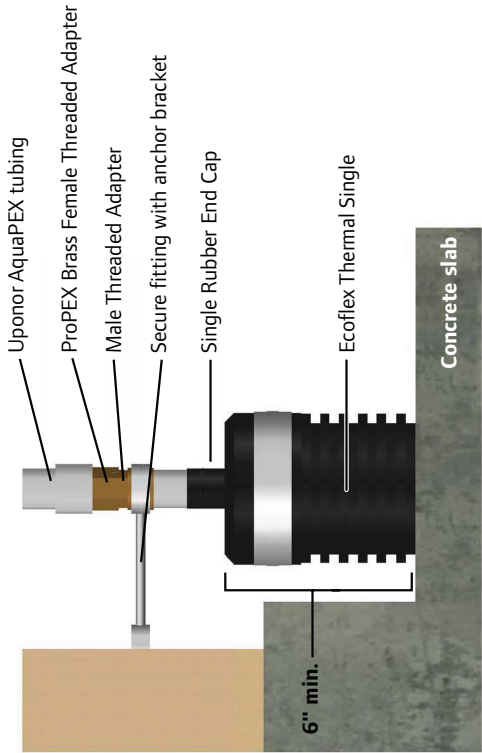
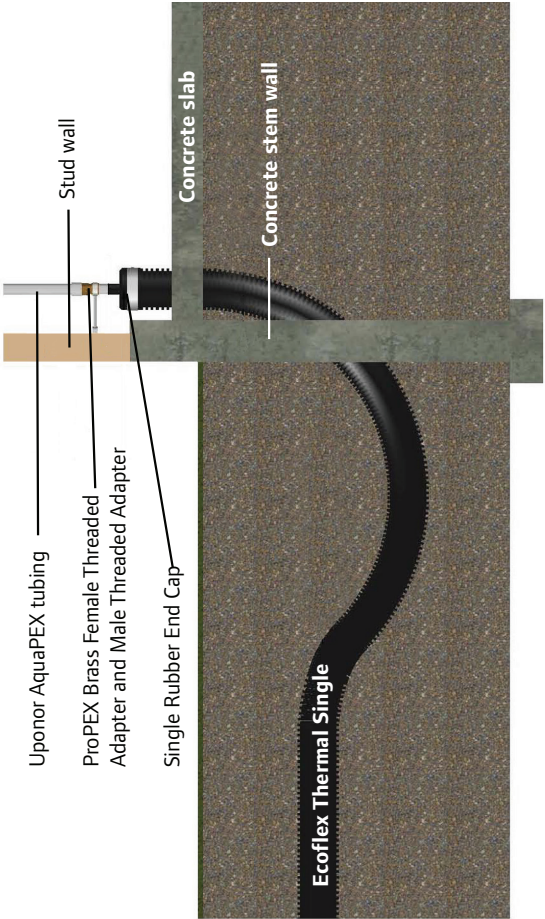

Slab-on-grade Installation

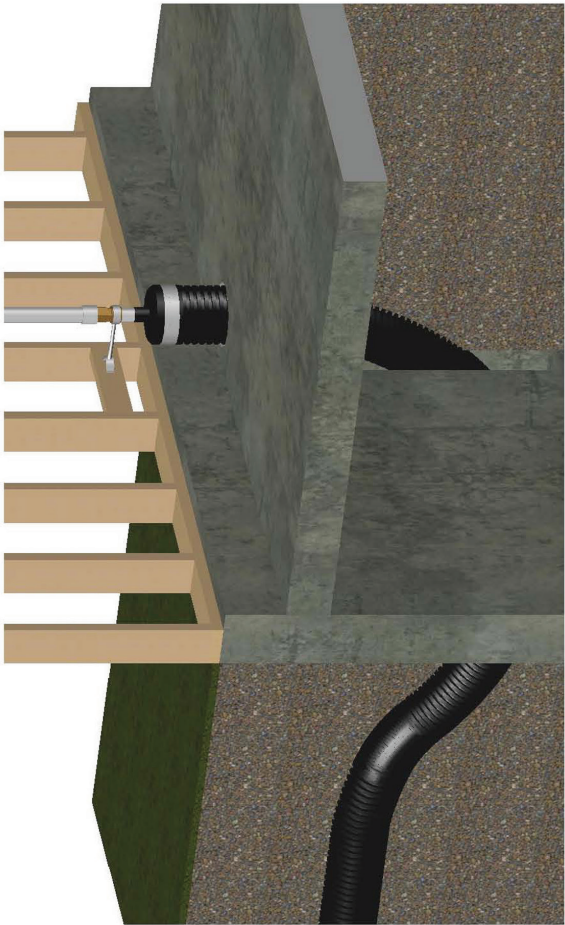

Slab-on-grade Installation — Interior Wall Attachment

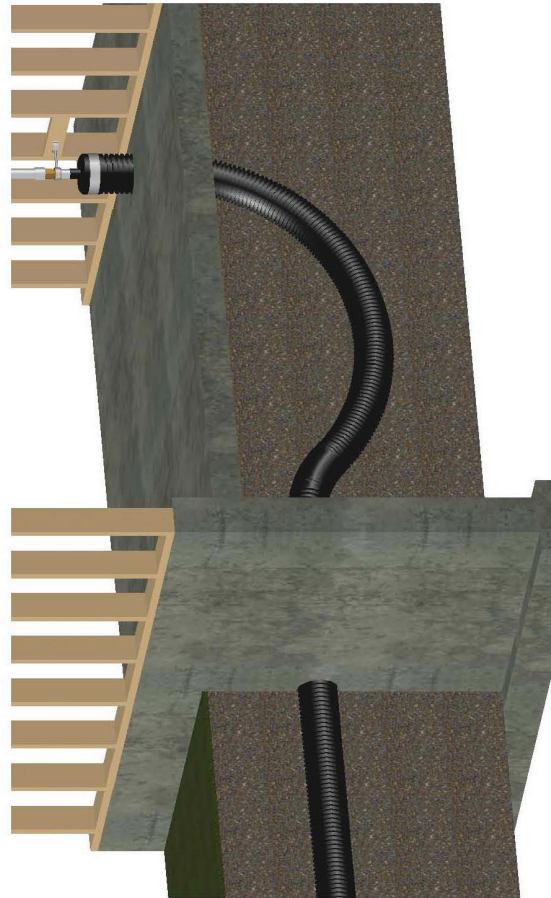
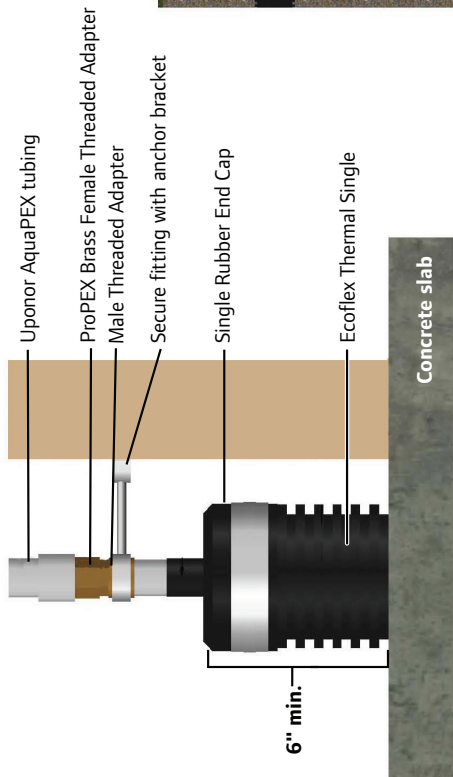
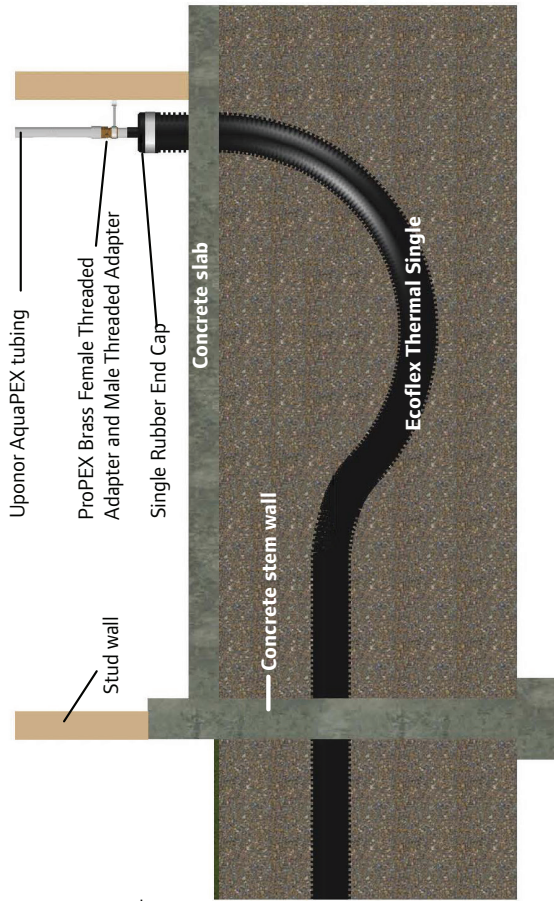

Slab-on-grade Installation — Under Footing

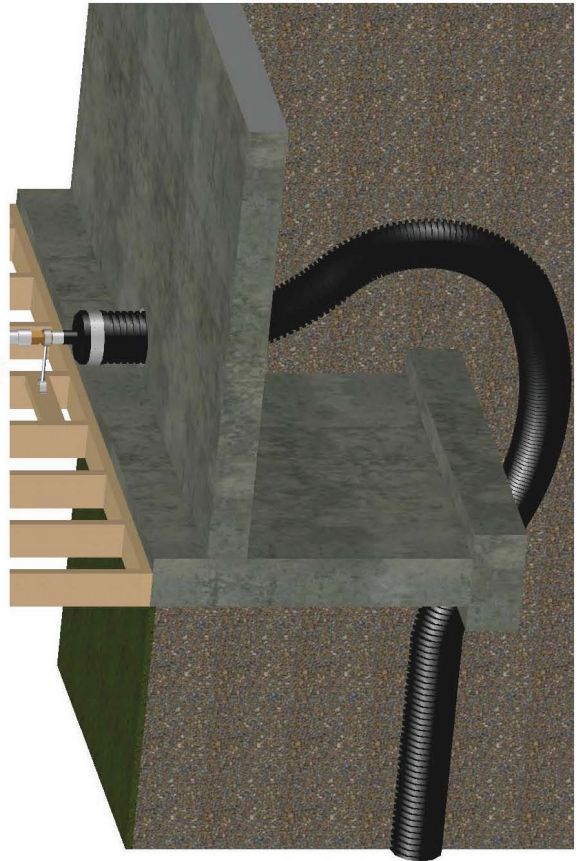
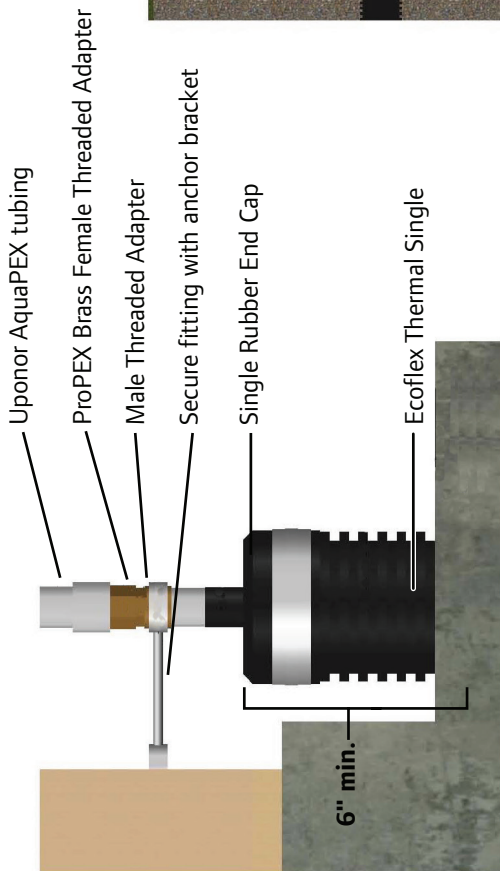
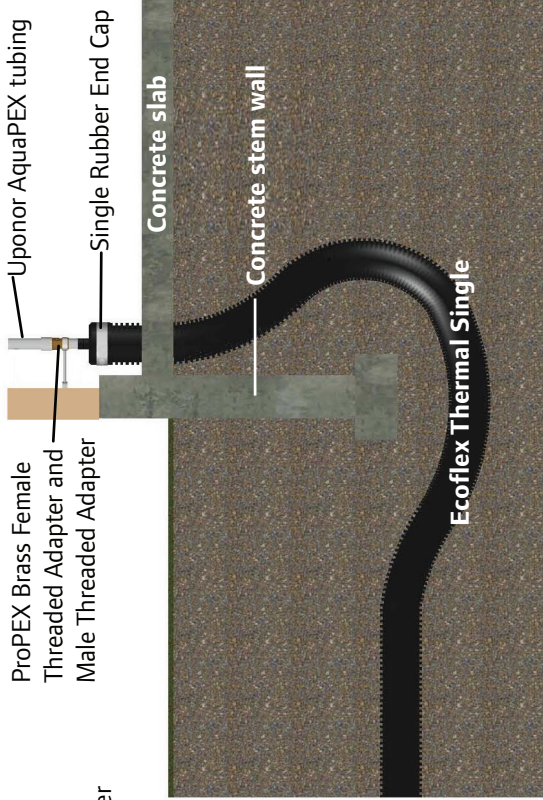

Uponor, Inc.
5925 148th Street West
Apple Valley, MN 55124 USA
Tel: (800) 321-4739
Fax: (952) 891-2008
Web: www.uponor-usa.com

Uponor Ltd.
2000 Argentia Rd., Plaza 1, Ste. 200
Mississauga, ON L5N 1W1 CANADA
Tel: (888) 994-7726
Fax: (800) 638-9517
Web: www.uponor.ca

The logo for Uponor, featuring the word "uponor" in a bold, blue, lowercase sans-serif font.