

C7915A Infrared Flame Detector

PRODUCT DATA

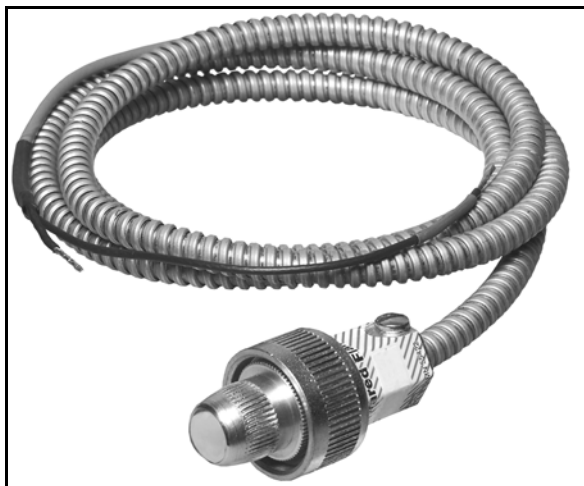

- Mounts easily on a standard 3/4 inch sight pipe.
- The infrared sensor plugs into an electrical socket in the C7915A assembly and is field replaceable.
- The lead sulfide photocell's sensitivity to infrared radiation is compatible with a wide range of flame supervisory applications.
- Flexible metal cable protects and electrically shields the detector coaxial cables.
- Accessories available include a heat block, seal-off adapter, reducer bushing, and orifice plate.
- Immune to x-ray testing.

SPECIFICATIONS

STANDARD MODELS

MODELS: See Table 6 for flame safeguard controls and associated amplifiers.

DETECTOR RESPONSE: Responds to infrared radiation with wavelengths between 0.75 and 1.0 micron.

LEAD SULFIDE PHOTOCELL: Photo conductor resistance decreases as incident radiant energy increases.

AMBIENT TEMPERATURE RATING: -40°F to 125°F (-40°C to 52°C) maximum at the lead sulfide photocell.

MOUNTING:

C7915A Mount—knurled collar with 3/4-14 NPSM internal threads for mounting on a standard 3/4 in. pipe (see Fig. 1).

32007255-001 Lead Sulfide Photocell—two leads for inserting into socket in C7915A (see Fig. 8).

APPLICATION

The C7915A Flame Detector includes a lead sulfide photocell that is sensitive to the infrared radiation emitted by the combustion of fuels such as natural gas, oil, and coal.

- Particularly suitable for combination or dual-fuel applications.
- When installed properly, can supervise the pilot flame and/or the main burner flame.

Contents

Application	1
Specifications	1
Ordering Information	2
Operation	3
Installation	3
Wiring	8
Adjustments and Checkout	10
Troubleshooting	11



Table 1. Models Available

Model	Coaxial Cable Length		Lead Sulfide Cell	Components Included			
	(in.)	(m)		50019469-001 Bushing With Magnifying Lens	105134 Orifice Plate ^a	105061 Heat Block ^b	390427A Reducer Bushing ^c
C7915A1010	30	0.76	32007255-001	X	X		
C7915A1036	96	2.44	32007255-001	X	X		
C7915A1028	48	1.22	32007255-001	X	X	X	X

^a With 0.125 in. (3.175 mm) diameter hexagonal orifice to reduce the detector field of view.

^b To insulate the detector from sight pipe temperatures higher than -40°F–125°F (-40°C–52°C) and up to 250°F (121°C).

^c To mount the detector on a 1/2 in. sight pipe, specifically to replace Fireye™ lead sulfide infrared flame detectors.

WIRING CONNECTIONS

Nominal 48 in. (1.22 m) coaxial cables—rated for 194°F (90°C); terminated—one blue and one white.

Coaxial cables enclosed in flexible metal cable—3/8 in. (9.6 mm) maximum outer diameter.

DIMENSIONS: See Fig. 1.

SIL 3 CAPABLE:

The C7915 when used with a R7852B Ampli-check amplifier in Relay Module EC7810A, 20A, 30A, 40L, 50A; RM7800[E,G,L,M], 30A, 38[A,B,C], 40[E,G,L,M] 50A, 90[A,B,C,D], 97[A,C], 98A is SIL 3 Capable in a properly designed Safety Instrumented System. See form number 65-0312 for Certificate Agreement.

APPROVALS:

Underwriters Laboratories Inc. listed: File No. MP268.

Canadian Standards Association certified: Master file LR-95329-1.

Factory Mutual approved.

Swiss Re (formerly Industrial Risk Insurers): acceptable.

IMPORTANT:

Caution, stickers, form 96-610, are included with the C7915A. Underwriters Laboratories Inc. requires that this sticker be placed on any junction box in which C7915A coaxial cables are connected. The sticker prohibits routing any other wiring through the junction box.

REPLACEMENT PARTS:

32007255-001 Lead Sulfide Photocell

50019469-001 Bushing with Focusing Lens

105061 Heat Block to insulate the detector from sight pipe temperatures higher than 125°F (52°C) and up to 250°F (121°C).

390427A Reducer Bushing, to mount the detector on a 1/2 in. sight pipe; specifically to replace Fireye™ lead sulfide infrared flame detectors.

ACCESSORIES:

105172A Seal-Off Adapter; with glass window to prevent hot gases from reaching the lead sulfide photocell.

118367A Swivel Mount; provides adjustable positioning of the C7915A.

Hookup Cable—R1298020; 2-wire, heat- and moisture-resistant, No. 20 AWG, Teflon (TFE) insulated; rated up to 400°F (204°C) for continuous duty; tested for operation up to 600 volts and breakdown up to 7500 volts.

ORDERING INFORMATION

When purchasing replacement and modernization products from your TRADELINE® wholesaler or distributor, refer to the TRADELINE® Catalog or price sheets for complete ordering number. If you have additional questions, need further information, or would like to comment on our products or services, please write or phone:

1. Your local Honeywell Environmental and Combustion Controls Sales Office (check white pages of your phone directory).
2. Honeywell Customer Care
1885 Douglas Drive North
Minneapolis, Minnesota 55422-4386
3. <http://customer.honeywell.com> or <http://customer.honeywell.ca>

International Sales and Service Offices in all principal cities of the world. Manufacturing in Belgium, Canada, China, Czech Republic, Germany, Hungary, Italy, Mexico, Netherlands, United Kingdom, and United States.

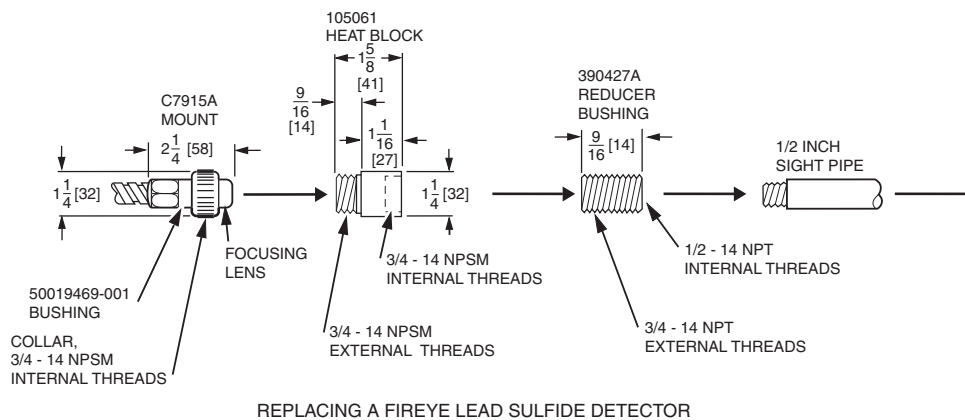
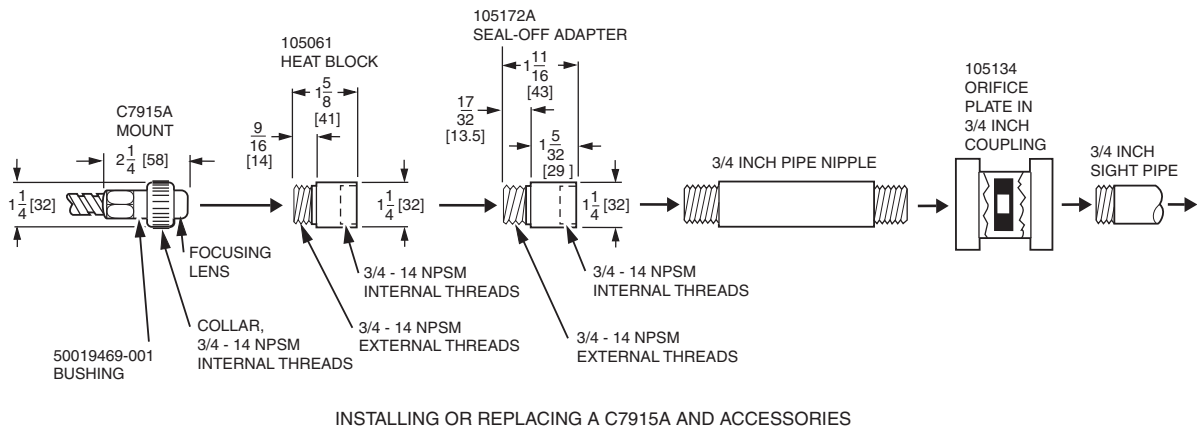

M23448A

Fig. 1. Mounting dimensions of C7915A Infrared Flame Detector and accessories, in inches. (mm).

OPERATION

OPERATION OF INFRARED DETECTORS

Infrared detectors can be used with gas, oil, coal, or dual-fuel flames. Since more than 90% of the total flame radiation is infrared, these detectors receive ample radiation and can detect weak flames as well as flames of higher intensity.

The lead sulfide cell used in the detector cannot distinguish between the infrared radiation emitted by hot refractory and the infrared radiation from a flame. Therefore, the infrared detection system includes an amplifier that responds only to the flickering characteristic of flame radiation and rejects the steady radiation characteristic of hot refractory.

Unfortunately, smoke or fuel mist within the combustion chamber can intermittently reflect, bend, or block the hot refractory radiation, thus making it fluctuate. This fluctuating action can simulate the flickering radiation from a flame, and infrared radiation may be present even after the refractory has visibly stopped glowing. Therefore, be very careful when applying an infrared detection system to be sure it responds only to flame.

CELL CONSTRUCTION

The photosensitive material used in the infrared detector is lead sulfide. The electrical resistance of lead sulfide decreases when exposed to infrared radiation. If a voltage is applied across the lead sulfide photocell, current flows when the cell is exposed to infrared radiation.

INSTALLATION

WHEN INSTALLING THIS PRODUCT...

1. Read these instructions carefully. Failure to follow them could damage the product or cause a hazardous condition.
2. Check the ratings given in the instructions and on the product to make sure the product is suitable for your application.
3. Installer must be a trained, experienced flame safeguard control service technician.
4. After installation is complete, check out product operation as provided in these instructions.

CAUTION

Electrical Shock Hazard.

Disconnect power supply before beginning installation to prevent electrical shock and equipment damage; there may be more than one disconnect.

All wiring must be NEC Class 1 (line voltage).

Use the C7915A only with Honeywell lead sulfide photocells (part no. 32007255-001) and flame signal amplifiers specified (see Table 6).

NOTICE

Per industry standards, a conduit seal or a cable type that is sealed is required to be installed in a device that can result in flammable gas or flammable liquid flow through a conduit or cable to an electrical ignition source in the event of a seal leakage or diaphragm failure.

Proper flame detector installation is the basis of a reliable flame safeguard installation. Refer to the burner manufacturer instructions and instructions below. Carefully follow instructions for the best possible flame detector application.

BASIC REQUIREMENTS

Because all flames produce infrared radiation, a C7915A Infrared (lead sulfide) Flame Detector can be used to prove the presence of a flame in a combustion chamber. The detector is mounted outside the combustion chamber. Screw the mounting collar to one end of a sight pipe inserted through the wall of the combustion chamber. The lead sulfide photocell in the detector sights the flame through the sight pipe.

When a flame is present, the lead sulfide photocell detects the infrared radiation generated. The C7915A produces an electric signal that is sent to the amplifier in the flame safeguard control. The amplified signal pulls in the flame relay in the flame safeguard control to allow proper operation.

Because it is necessary for the detector to actually see the flame, it is best to locate the detector as close to the flame as physical arrangement, temperature, and other restrictions permit. These restrictions are described in detail below.

DETERMINE THE LOCATION

Before beginning the actual installation, determine the best location for mounting the flame detector. Carefully consider the factors discussed in this section before establishing the location.

TEMPERATURE

The sensitivity of the lead sulfide cell decreases as its temperature increases. Up to 125°F (52°C), the loss in sensitivity is negligible, but temperatures above this point *must be avoided*. Under normal temperature conditions (below 125°F (52°C), the life of the lead sulfide cell should be unlimited. The quickest check for excessive temperature is simply to grasp the detector—it should not be too hot to hold comfortably in your bare hand.

Several methods are available for cooling the lead sulfide photocell including ventilating the sight pipe and installing a pipe nipple, seal-off adapter, and/or heat block between the sight pipe and the detector. Refer to Installing Accessories, page 7.

SIGHTING

The infrared detector must continually sight a stable portion of the flame being detected. The detector is commonly applied to detect both the gas pilot and main gas flame, or the gas pilot and main oil flame. *In either case, the detector must be carefully aimed at the intersection of the pilot and main flame.* A Swivel Mount (Honeywell part no. 118367A) is available to facilitate flame sighting after the C7915A is mounted.

FIELD OF VIEW

A lead sulfide photocell, like other photocells, views an area rather than a point. It is unable to pinpoint pilot flame location as easily as a flame rod. *If the detector is to prove only the pilot flame, it must view only a part of the flame so it can detect the pilot only when it is large enough to successfully light the main burner.* The viewing area must not be so large that a weak and wavering pilot flame could energize the photocell and cause the flame relay to pull in.

The area viewed by the photocell depends on:

1. Diameter of the opening in front of the cell.
2. Distance from the cell to the opening.
3. Distance from the opening to the area to be viewed.

Fig. 2 shows three ways of reducing the field of view, assuming that the distance from the viewing opening to the flame or refractory cannot be changed. These are (1) lengthening the sight pipe, (2) reducing the diameter of the sight pipe, and (3) installing an orifice plate in front of the photocell. Combinations of these methods can be used.

CHANGING PIPE LENGTH OR SIZE (DIAMETER)

The effect of changing the length of the sight pipe is shown in Table 2 and 3.

Changing the diameter of the sight pipe is not as simple as changing the length, because the C7915A mount and mounting accessories are all sized for 3/4 in. pipe. When the sight pipe diameter is reduced, the effect is the same as adding an orifice plate to the pipe as discussed below.

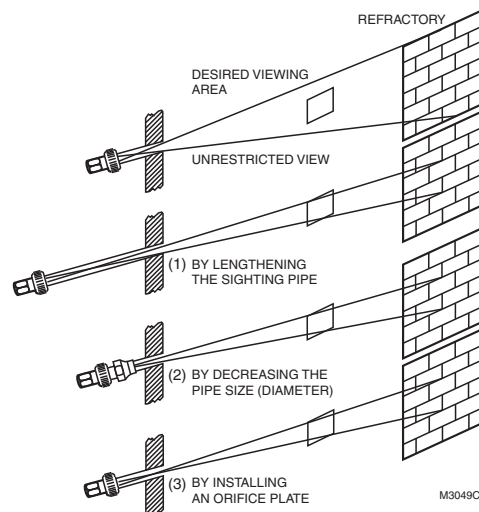

Fig. 2. Methods of reducing C7915A Detector field-of-view.

Table 2. Diameter of Area Sighted Through Various Lengths of 3/4-in. Pipe Without Orifice, in inches.

Length of Pipe—in.	Distance From End of Pipe To Sighted Area—in.											
	6	12	18	24	30	36	42	48	54	60	66	72
1	6.3	11.9	17.6	23.2	28.4	34.5	Over 40					
2	3.5	6.3	9.1	11.9	14.8	17.6	20.4	23.2	26.0	28.9	31.7	34.5
3	2.6	4.4	6.3	8.2	10.1	11.9	12.9	15.7	17.6	19.5	21.3	23.2
4	2.1	3.5	4.9	6.3	7.8	9.1	10.6	11.9	13.4	14.8	16.2	17.6
5	1.8	2.9	4.1	5.2	6.3	7.5	8.6	9.7	10.7	11.9	13.1	14.2
6	1.6	2.6	3.5	4.4	4.3	6.3	7.3	8.2	9.1	10.1	11.0	11.9
7	1.5	2.3	3.1	3.9	4.7	5.5	6.3	7.1	8.0	8.7	9.6	10.4
8	1.4	2.1	2.8	3.5	4.2	4.9	5.6	6.3	7.1	7.7	8.5	9.1

Table 3. Diameter of Area Sighted Through Various Lengths of 3/4-in. Pipe Without Orifice, in mm.

Length of Pipe—mm	Distance From End of Pipe To Sighted Area—mm											
	152.4	304.8	457.2	609.6	762.0	914.4	1066.8	1219.2	1371.6	1524.0	1676.4	1828.8
25.4	160.0	302.3	447.0	589.3	721.4	876.3	Over 1016.0					
50.8	88.9	160.0	231.1	302.3	375.9	447.0	518.2	589.3	660.4	734.1	805.2	876.3
76.2	66.0	111.8	160.0	208.3	256.5	302.3	327.7	398.8	447.0	495.3	541.0	589.3
101.6	53.3	88.9	124.5	160.0	198.1	231.1	269.2	302.3	340.4	375.9	411.5	447.0
127.0	45.7	73.7	104.1	132.1	160.0	190.5	218.4	246.4	271.8	302.3	332.7	360.7
152.4	40.6	66.0	88.9	111.8	137.2	160.0	185.4	208.3	231.1	256.5	279.4	302.3
177.8	38.1	58.4	78.7	99.1	119.4	139.7	160.0	180.3	203.2	221.0	243.8	264.2
203.2	35.6	53.3	71.1	88.9	106.7	124.5	142.2	160.0	180.3	195.6	215.9	231.1

INSTALLING AN ORIFICE PLATE

An orifice plate with a hexagonal orifice diameter of 0.125 in. (3.2 mm) is supplied with the C7915A Infrared Flame Detector. The orifice can be mounted in front of the cell in the seal-off adapter or in a standard 3/4 in. coupling. (Refer to Fig. 1.)

The size of the sighted area at various distances can be determined from Table 4 or 5. For example, if the distance from the photocell to a 0.125 in. (3.175 mm) diameter orifice is 4 in. (101.6 mm), and from the orifice to the flame junction (or refractory) is 36 in. (914.4 mm), the diameter of the sighted area is 2.4 in. (61 mm).

Fig. 3 shows how a typical orifice plate restricts the view of a small area around the flame junction.

Table 4. Diameter of Area Sighted Through Orifice, in inches.

Cell To Orifice Distance (in.)	Orifice Diameter—in. 0.125					
	Distance From Orifice To Sighted Area—in.					
	12	24	36	48	60	72
1	3.2	6.1	8.8	Over 10		
2	1.6	3.2	4.6	6.1	7.6	8.8
3	1.1	2.1	3.2	4.2	5.2	6.1
4	Less than 1	1.6	2.4	3.2	3.9	4.6
5	—	1.3	1.9	2.5	3.2	3.8
6	—	1.1	1.6	2.1	2.6	3.2

Table 5. Diameter of Area Sighted Through Orifice, in mm.

Cell To Orifice Distance (mm)	Orifice Diameter—in. 0.125					
	Distance From Orifice To Sighted Area—mm.					
	12	24	36	48	60	72
25.4	81.3	154.9	223.5	Over 254.0		
50.8	40.6	81.3	116.8	154.9	193.0	223.5
76.2	27.9	53.3	81.3	106.7	132.1	154.9
101.6	Less than 25.4	40.6	61.0	81.3	99.1	116.8
127.0	—	33.0	48.3	63.5	81.3	96.5
152.4	—	27.9	40.6	53.3	66.0	81.3

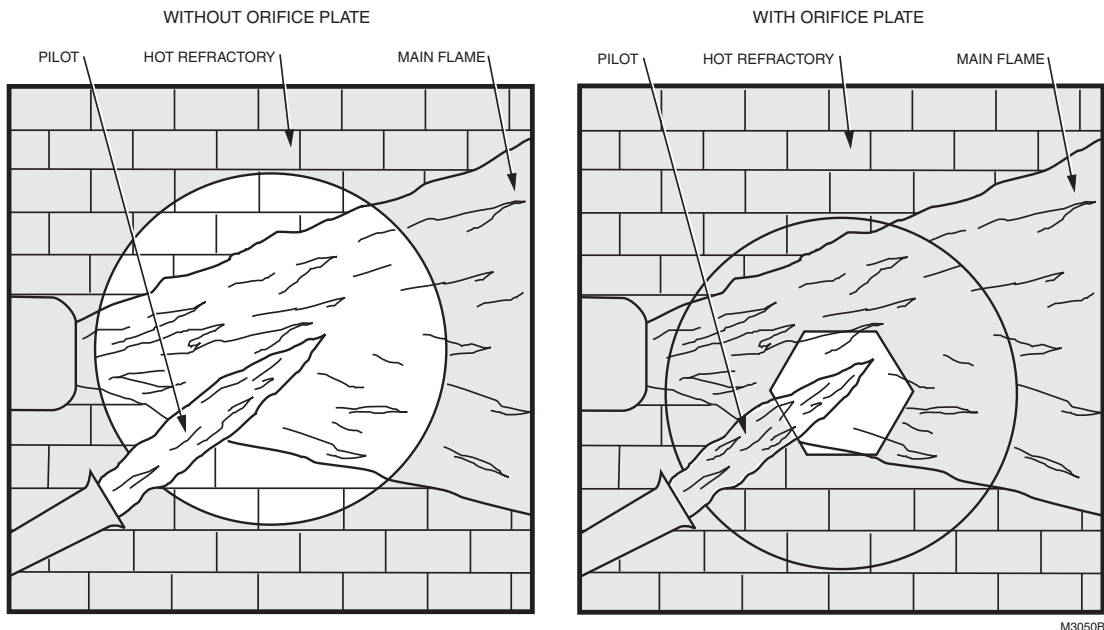

Fig. 3. Using orifice plate to restrict detector field of view to intersection of pilot and main flame, or to small area of hot refractory.

RESPONSE TO HOT REFRACTORY

Although the infrared amplifier will not respond to steady radiation, as produced by hot refractory, be careful to protect the infrared detector from hot refractory radiation because of two possible conditions, *shimmer* and *radiation saturation*.

- Shimmer**—Turbulent hot air, steam, smoke, or fuel spray in the combustion chamber can reflect, bend, or block the steady infrared radiation emitted by a hot refractory. These conditions can change the steady radiation from a hot refractory into a fluctuating radiation. If these fluctuations occur at the same frequency as that of a flickering flame, they will simulate flame and will hold in the flame relay after the actual burner flame has been extinguished.
- Radiation saturation**—Steady hot refractory radiation can become strong enough to mask the fluctuating radiation of the flame. This is similar to the effect of holding up a candle in front of the sun—the light of the sun is so strong that the candle light cannot be seen. If radiation saturation is extreme, the flame relay will drop out, and the system will shut down as though a flame failure has occurred.

Both of these problems will be minimized by aiming the detector at a portion of the refractory that is:

- as cool as possible.
- as far from the cell as possible.
- as reduced a field of view as possible, see Fig. 2 and 3.

Refractory temperatures in the combustion chamber will vary with combustion chamber design, but generally the end wall of the chamber will be the hottest point. It will normally be best to aim the detector at the side wall of the refractory (Fig. 4), at a point above the refractory (Fig. 5), or at the floor of the combustion chamber (Fig. 6).

SIGHTING SUMMARY

When sighting the detector, two important factors to consider are: (1) proper sighting of the flame being detected (normally the pilot/main flame junction), and (2) avoiding hot refractory sighting.

A typical sighting arrangement is shown in Fig. 4. The detector is aimed at the intersection of the pilot and main flames, and at a relatively cool side of the combustion chamber. The detector, in this case, would be located as close as possible to the burner to sight the maximum depth of the flame and reduce the effect of variations in the main flame pattern.

The detector can also be sighted from a point below and close to the burner with the line-of-sight above the refractory (Fig. 5).

The third method is to aim the detector from above the burner, sighting a portion of the refractory floor (Fig. 6). This type of application requires that the pilot flame be carefully sighted from the side. The detector should not be sighted *over the shoulder* of the pilot because the chances increase of sighting a pilot too small to satisfactorily light the main flame.

The actual area of hot refractory sighted should be as small as possible and consistent with proper sighting of the flame. Refer to Fig. 2 and 3 for methods of reducing the area of hot refractory sighted.

CLEARANCE

Make sure there will be enough room to easily mount the sight pipe, flame detector, and all required accessories, and to remove the flame detector for troubleshooting and servicing.

INSTALLING THE SIGHT PIPE

The location of the sight pipe is the most critical part of the installation. A 3/4 in. black iron sight pipe is recommended. Do not use a stainless steel or galvanized pipe because its internal surface blackens with use as deposits from the combustion chamber accumulate on it. Initially, its shiny internal surface reflects infrared radiation, which could result in a satisfactory flame signal even though the pipe may be improperly located. As it blackens, less infrared radiation is reflected and the flame signal becomes marginal.

Because no two situations are the same, the length and sighting angle of the pipe must be determined at the time and place of installation. Generally, it is desirable to have the sight pipe tilting downward to prevent soot or dirt buildup.

PREPARE HOLE IN WALL OF COMBUSTION CHAMBER

Form a hole of the proper diameter for the sight pipe in the wall of the combustion chamber at the selected location. Flare the hole (Fig. 9) to leave room for small adjustments of the sighting angle. The taper of the hole should be about 1 in. for every 3 in. (25.4 mm for every 76.2 mm) of wall thickness.

INSTALLING ACCESSORIES

It may be necessary or desirable to install accessories between the sight pipe and the detector. This section describes the installation of these accessories.

SIGHT PIPE VENTILATION

It may be necessary to ventilate the sight pipe to cool the detector.

For a negative pressure combustion chamber, drilling a few holes in the section of the sight pipe outside of the combustion chamber allows air at atmospheric pressure to flow through the sight pipe into the chamber. A perforated pipe nipple between the sight pipe and the flame detector can also be used. See Fig. 7.

For a positive pressure combustion chamber, connect a supply of pressurized air from the burner blower to flow through the sight pipe into the chamber. The air pressure must be greater than the chamber pressure.

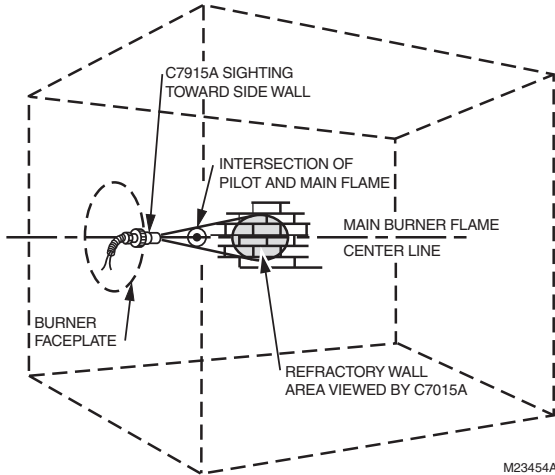

Fig. 4. C7915A Infrared Flame Detector aimed at side wall of combustion chamber.

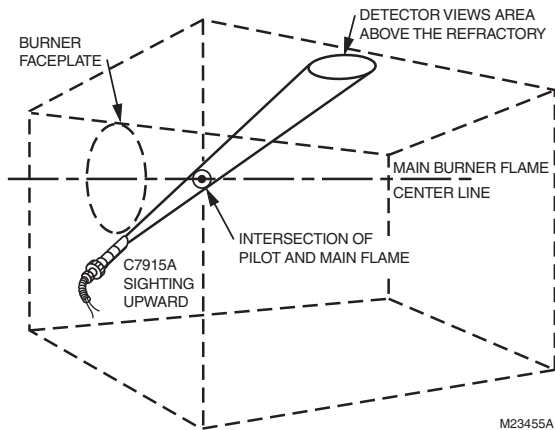

Fig. 5. C7915A Infrared Flame Detector aimed at a point above refractory.

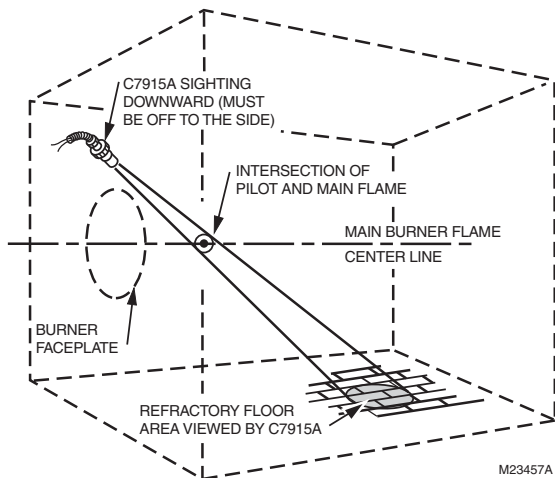

Fig. 6. C7915A Infrared Flame Detector aimed at floor of combustion chamber.

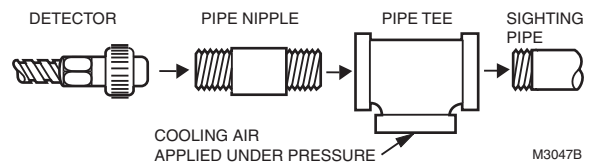

Fig. 7. Forced air cooling.

SWIVEL MOUNT

To facilitate flame sighting, a Swivel Mount (part no. 118367A) is available. The Swivel Mount requires a reducer of the proper size to mount it onto the sight pipe. (For mounting details, refer to form 60-0361 for the 118367A Swivel Mount.)

REDUCER BUSHING

To mount the detector on a 1/2 in. sight pipe, *specifically if replacing a Fireeye™ lead sulfide detector*, install a 390427A Reducer Bushing (Fig. 1).

ORIFICE PLATE

To reduce the detector field-of-view, and restrict it to the intersection of the pilot and main flame, or to a small area of hot refractory (see Fig. 3), install a 105134 Orifice Plate. The orifice plate can be inserted into a standard 3/4 in. pipe coupling (Fig. 1) or into the seal-off adapter, if used.

MOUNTING SIGHT PIPE

Thread one end of the pipe to fit the mounting collar on the detector (or an accessory, if used, see Fig. 1). Cut the pipe to the desired length (as short as practical). *To avoid conducting excessive heat back to the lead sulfide photocell, the sight pipe should not extend more than halfway into the refractory.* Tack weld the pipe to the wall in a trial position (Fig. 9). *Do not permanently weld the sight pipe in place until after completing the Adjustments and Checkout, page 10.*

NOTE: If you use a Swivel Mount (part no. 118367A) and you are positive about the location and sighting angle, you can permanently weld the pipe.

PIPE NIPPLE

A 3/4 in. pipe nipple, 6 to 8 in. (152 to 203 mm) long, can be inserted between the sight pipe and the C7915A Mount (Fig. 1) to help cool the lead sulfide cell. Using the pipe nipple will also reduce the viewing area of the detector (see Table 4 or 5).

SEAL-OFF ADAPTER

To protect the detector from hot gases, install a 105172A Seal-Off Adapter (Fig. 1). The adapter has a glass window that prevents hot gases from reaching the lead sulfide photocell.

HEAT BLOCK

To insulate the detector from sight pipe temperatures above 125°F (52°C), install a 105061 Heat Block (Fig. 1). The device is made of non-heat-conductive, laminated plastic that prevents heat from being conducted from the sight pipe to the detector. It can withstand temperatures up to 250°F (121°C).

MOUNTING THE DETECTOR

Before mounting the C7915A, install the lead sulfide photocell (if not installed already).

Unscrew the bushing from the cap, plug the photocell into the cell mount, and screw the bushing back into the cap (Fig. 8). The bushing also includes a focusing lens to concentrate available radiation on the photocell face.

Mount the C7915A Detector onto the sight pipe, heat block, or other accessory (Fig. 1 and 9). Screw the mounting collar onto the sight pipe or accessory.

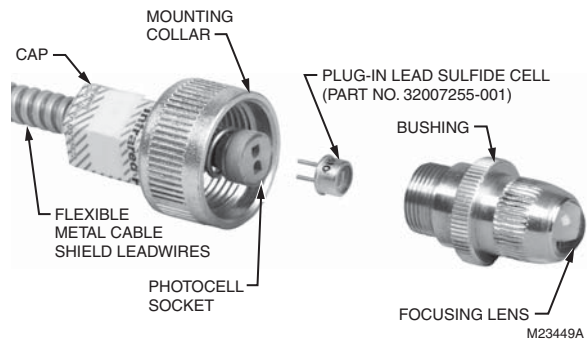

Fig. 8. Installing lead sulfide photocell.

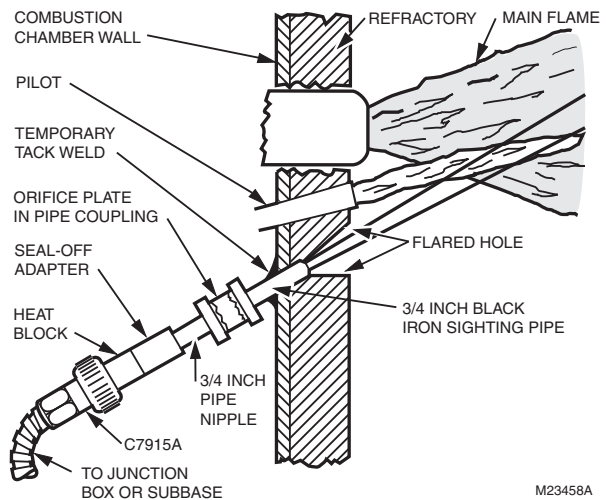

Fig. 9. Mounting C7915A Infrared Flame Detector (and accessories).

WIRING



CAUTION

Electrical Shock Hazard.

Disconnect power supply before beginning installation to prevent electrical shock and equipment damage, there may be more than one disconnect involved.

NOTICE

Per industry standards, a conduit seal or a cable type that is sealed is required to be installed in a device that can result in flammable gas or flammable liquid flow through a conduit or cable to an electrical ignition source in the event of a seal leakage or diaphragm failure.

1. All wiring must comply with applicable electrical codes, ordinances, and regulations. Use NEC Class 1 wiring.
2. Keep the coaxial cables from the flame detector to the flame safeguard control subbase as short as possible. Capacitance increases with coaxial cable length, reducing the signal strength. The maximum permissible coaxial cable length is fifty feet. *The ultimate limiting factor in coaxial cable length is the flame signal current/voltage.* Refer to Table 6, Adjustments and Checkout, page 10.
3. The detector comes with 30, 48, or 96 in. (0.76, 1.22, or 2.44 m) coaxial cable inside a flexible metal cable. The coaxial cable is terminated with two leads—one blue and one white. The coaxial cable is rated for 194°F (90°C). The cable protects and electrically shields the coaxial cables.
4. If the coaxial cables are not long enough to reach the terminal strip or wiring subbase, make the required splices in a junction box (see IMPORTANT below).
5. If splicing is necessary, use moisture-resistant no. 14 wire suitable for at least 167°F (75°C) if the detector is used with a flame safeguard *primary* control, or at least 194°F (90°C) if used with a flame safeguard programming control.
6. *For splicing in high temperature installations*, use Honeywell specification no. R1298020 or equivalent for the F coaxial cable. (This wire is rated up to 400°F [204°C] for continuous duty. It is tested for operation up to 600 volts and breakdown up to 7500 volts.) For the other coaxial cable, use moisture-resistant no. 14 wire selected for a temperature rating above the maximum operating temperature.

IMPORTANT:

1. Flame detector coaxial cables must be as short as possible. The maximum coaxial cable length from the flame detector to the flame safeguard control is 50 ft (15.2 m).
2. Extensions to the flame detector coaxial cables must be run alone in either rigid or flexible metal conduit. When flame detector coaxial cables exit a conduit, they must be as short as possible, twisted, and not be included in bundles or channels that contain other wires. Rigid metal conduit is preferred when flame detector coaxial cables are extended but flexible metal conduit may be used if it is supported to minimize movement.
3. The flame detector flexible cable shield must be grounded to the flame safeguard control subbase either directly or through the metal cabinet/conduit system that contains the flame safeguard control subbase and flame detector coaxial cables.
4. When flame detector coaxial cables are routed through junction boxes, identify the junction boxes with the pressure-sensitive labels provided with the flame detector (form 96-610).
5. UNDERWRITERS LABORATORIES INC. REQUIRES THAT THE JUNCTION BOX BE MARKED TO INDICATE THAT NO OTHER WIRING CONNECTIONS CAN BE ROUTED THROUGH IT. APPLY CAUTION STICKER (FORM 96-610, FURNISHED) TO THE JUNCTION BOX.
6. Maximize the separation between ignition transformer high voltage wires and the flame sensor wires to avoid ignition interference.

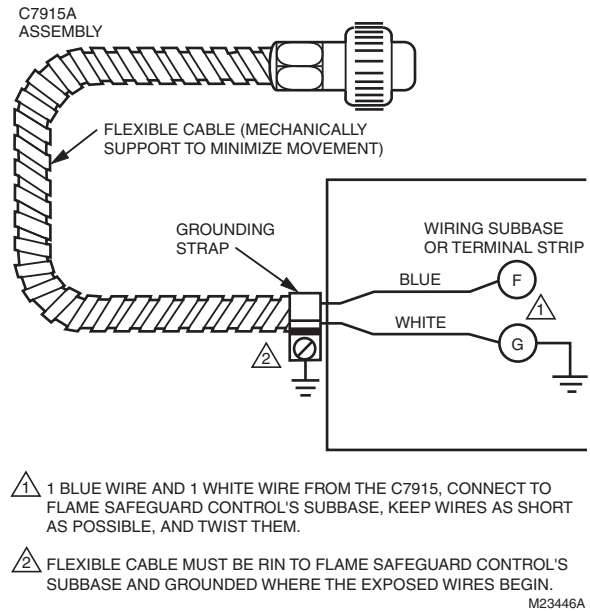

Fig. 10. Typical wiring of C7915A Infrared Flame Detector to nearby wiring subbase or terminal strip.

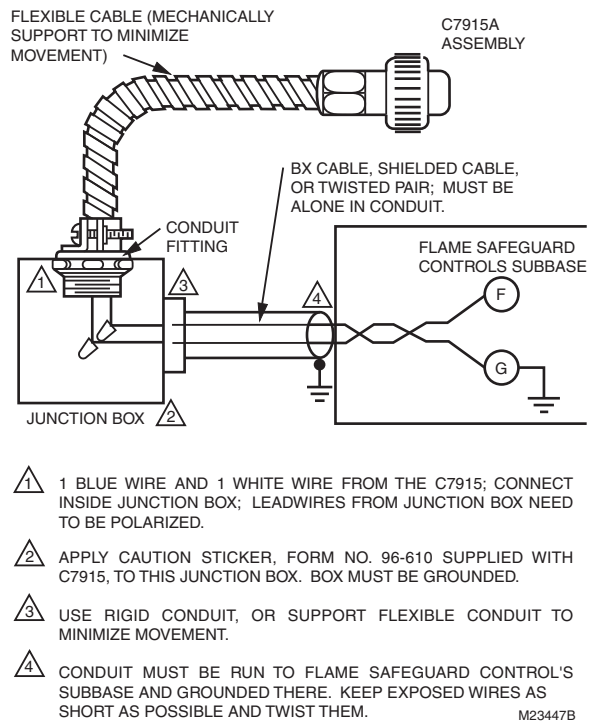

Fig. 11. Typical wiring of C7915A Infrared Flame Detector to distant wiring subbase or terminal strip.

ADJUSTMENTS AND CHECKOUT

IMPORTANT:

Before welding the sight pipe in its final location, complete the Adjustments and Checkout Tests below and any tests required by the burner manufacturer.

ADJUST DETECTOR SIGHTING POSITION

For initial burner light off, consult the burner manufacturer instructions or flame safeguard control instructions.

With the flame detector installed and the burner running, adjust the sighting position of the detector for optimum flame signal.

Refer to Table 6 for the minimum acceptable flame signal for the amplifiers and associated flame safeguard controls.

The R7852B (AMPLI-CHECK™) amplifiers have a dc voltage flame signal output.

To measure the flame signal voltage when using R7852A,B amplifiers, a volt-ohm meter with a minimum sensitivity of one megohm/volt is recommended. The flame signal (voltage) measurements are made as shown in Fig. 12. The positive (red) meter lead is connected to the positive (+) control jack and the negative (black) meter lead to the negative (-) -Com jack. If the 7800 SERIES, R7140 controls have the Keyboard Display Module, a zero to five Vdc voltage is displayed on the module. Refer to Table 6 for minimum and maximum flame voltages.

Move the detector and sight pipe around to sight the flame at various positions and angles. Try to get a maximum steady meter reading. The signal must be above the minimum acceptable current/voltage listed in Table 6.

Measure the flame signal for the pilot alone, the main burner flame alone, and both together (unless monitoring only the pilot flame when using an intermittent pilot, or only the main burner flame when using direct spark ignition). Also measure the flame signal at high and low firing rates and while modulating in between (as applicable). With the detector in its final position, all required flame signals must be steady and as specified in Table 6. If you cannot obtain the proper signals, refer to the Troubleshooting section.

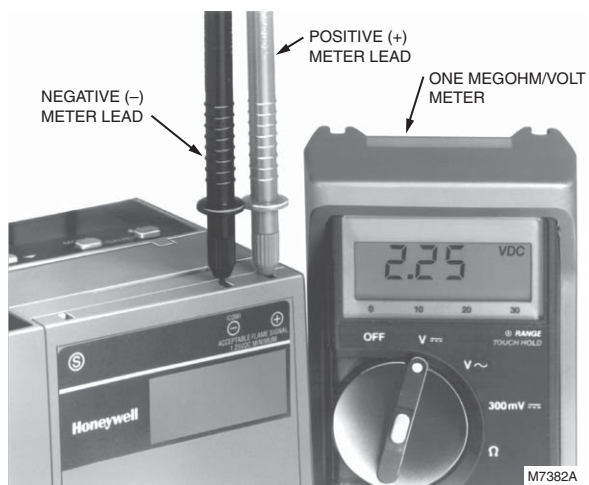

Fig. 12. Measuring 7800 SERIES, R7140 Flame Safeguard Control flame signal voltage.

Table 6. Flame Signal.

Flame Signal Amplifier	Flame Safeguard Control	Minimum Acceptable Steady Voltage (Vdc)	Maximum Expected Voltage (Vdc)
R7852A	RM7800E,G,L,M; RM7823A; RM7838A,B,C;	1.25	5.0
R7852B AMPLI-CHECK™	RM7840E,G,L,M; RM7885A; RM7890A,B; RM7895A,B,C,D; RM7896; RM7897; RM7898; R7140	1.25	5.0

PILOT TURNDOWN TEST

If the detector is used to prove a pilot flame before the main fuel valve can be opened, perform a Pilot Turndown Test before welding the sight pipe into position. Follow the procedures in the instructions for the appropriate flame safeguard control, and the burner manufacturer instructions.

HOT REFRACTORY SATURATION TEST

Test to be sure radiation from hot refractory does not mask the flickering radiation of the flame itself.

Start the burner and monitor the flame signal during the warmup period. A decrease in signal strength as the refractory heats up indicates hot refractory saturation. If saturation is extreme, the flame signal will decrease to a point that the system will shut down as though a flame failure has occurred.

If hot refractory saturation occurs, the condition must be corrected. Add an orifice plate in front of the photocell to restrict the viewing area. If this does not work, resocket the detector at a cooler, more distant background. Lengthening the sight pipe or decreasing the pipe size (diameter) may also be helpful. Continue adjustments until hot refractory saturation is eliminated.

HOT REFRACTORY HOLD-IN TEST

Test to make certain that hot refractory will not cause the flame to remain after the burner flame is extinguished. This condition would delay response to flame failure and also would prevent a system restart as long as the infrared radiation emitted by the hot refractory is detected.

First check the plug-in flame signal amplifier by initiating a burner cycle. When the system is in the *run* position, terminate the firing cycle while the refractory is at a low temperature. Measure the time it takes for the flame signal LED to go out after the flame goes out. If the flame signal LED fails to go out within four seconds, open the master switch and replace the amplifier.

Infrared detectors can respond to infrared radiation emitted by a hot refractory, even when the refractory has visibly ceased to glow. Infrared radiation from a hot refractory is steady, whereas radiation from a flame has a flickering characteristic. The infrared detection system responds only to a flickering infrared radiation; it can reject a steady signal from hot refractory. However, the refractory's steady signal can be made to fluctuate if it is reflected, bent, or blocked by smoke or fuel mist within the combustion chamber. Be careful when applying an infrared system to ensure its response to flame only.

To check a C7915A Infrared Flame Detector for hot refractory hold-in, operate the burner until the refractory reaches its maximum temperature. If the installation has a multifuel burner, burn the fuel most likely to reflect, bend, or obscure the hot refractory's steady infrared radiation (burn solids instead of liquids, or liquids instead of gases). When the maximum refractory temperature is reached, close all manual fuel shutoff valves or open the electrical circuits of all automatic fuel valves. Visually observe when the burner flame goes out. After the flame goes out, measure the time it takes for the flame signal LED to go out. If the flame signal LED fails to go out within four seconds, the infrared detector is sensing the radiation from hot refractory. Immediately terminate the firing cycle (lower the set point of the burner controller, or set the fuel selector switch to OFF). Do not open the master switch.

NOTE: Some burners continue to purge their oil lines between the valves and nozzles even though the fuel valve(s) is closed. Terminating the firing cycle (instead of opening the master switch) will allow purging of the combustion chamber. This will reduce a buildup of fuel vapors in the combustion chamber caused by oil line purging.

If the detector is sensing hot refractory radiation, the condition must be corrected. Add an orifice plate in front of the photocell to restrict the detector viewing area. If this does not work, resight the detector at a cooler, more distant part of the combustion chamber. While resighting the detector, remember that it must also properly sight the flame. Lengthening the sight pipe or decreasing the pipe size (diameter) may also be helpful. For details, refer to Installation. Continue adjustments until hot refractory hold-in is eliminated.

IGNITION INTERFERENCE TEST

It is possible for infrared amplifiers to respond to ignition spark electrical noise (interference) under certain conditions. Avoid ignition interference by locating the transformer as close as possible to the burner ignition electrode (preferably not on the control cabinet). You can also use an ignition cable that

suppresses electrical noise (such as the type of cable used in automobiles). Maintain maximum separation of flame sensor and ignition wiring.

To determine if an infrared flame amplifier responds to ignition interference, complete the following test sequence:

1. CLOSE MANUAL FUEL VALVES TO THE PILOT AND MAIN BURNER.
2. Connect a flame signal meter to the amplifier and start the burner.
3. There should be no flame signal when the ignitor is energized (momentary meter movement may be observed when the flame safeguard control switches a load on or off).

WELD THE SIGHT PIPE

After adjustments have been made and an acceptable flame signal obtained, remove the detector and weld the sight pipe in its final position (if you are using a swivel mount, the pipe may already be welded). Then reinstall the detector.

FINAL CHECKOUT

Before putting the burner into service, check out the installation by using the Checkout procedures in the instructions for the appropriate flame safeguard control. After completing the checkout, run the burner through at least one complete cycle to verify proper operation.



CAUTION

Complete Checkout Tests.

Do not put the system into operation until all Checkout tests in the instructions for the appropriate flame safeguard control and any specified in the burner installation instructions are satisfactorily completed.

TROUBLESHOOTING



CAUTION

Electrical Shock Hazard. Be extremely careful while troubleshooting the detector; line voltage is present on some of the terminals on the wiring subbase or terminal strip when power is on. Open the master switch to disconnect power before removing or installing the detector, there may be more than one disconnect involved.

If you cannot obtain a satisfactory flame signal while adjusting the sighting position of the detector, follow these procedures. If you encounter other problems in the system, refer to Troubleshooting in the instructions for the appropriate flame safeguard control.

EQUIPMENT REQUIRED

1. Voltmeter (Honeywell W136A or equivalent) with 0 to 300 Vac scale.
2. A one megohm/volt meter with a zero to 5 or 10 Vdc scale is recommended for 7800 SERIES, R7140 control flame voltage measurements. If the control has the Keyboard Display Module option, flame voltage is displayed on the module.
3. Replacement parts—see Specifications.

TROUBLESHOOTING PROCEDURES

First perform the Preliminary Inspection. Then follow the applicable procedures for either a low reading or a zero reading on the flame signal meter. After reinstalling the detector, recheck the meter reading. Adjust the position of the detector to try to obtain the proper flame signal. If the procedures are completed and a satisfactory flame signal cannot be obtained, replace the detector.

PRELIMINARY INSPECTION

1. Make sure that the flame is properly adjusted and is not too lean.
2. Check for the proper line voltage. Make sure the master switch is closed, connections are correct, and power supply is of the correct voltage and frequency.
3. Check the detector wiring for defects including:
 - incorrect connections.
 - wrong type or size of wire.
 - deteriorated wire.
 - open circuits.
 - short circuits.
 - leakage paths caused by moisture, soot, or dirt.
4. With the burner running, check the temperature at the detector. If it exceeds 125°F (52°C):
 - add additional insulation between the wall of the combustion chamber and the detector.
 - add a shield or screen to reflect radiated heat away from the detector.
 - add cooling (refer to Sight Pipe Ventilation, see Installation).

PROCEDURE FOR A LOW METER READING

1. Remove the detector and clean the focusing lens with a soft, clean cloth.
2. If the focusing lens is broken or damaged, or if it is coated with a substance that cannot be cleaned off, replace the 50019469-001 Bushing (which includes the focusing lens).
3. Clean the inside of the sight pipe before reinstalling the detector.
4. If the meter reading is still too low, replace the lead sulfide cell (Fig. 8).
5. If the meter reading is still too low, replace the plug-in amplifier.

6. If you still cannot obtain a proper flame signal, replace the C7915A Infrared Flame Detector.

PROCEDURE FOR A ZERO METER READING

1. Replace the lead sulfide cell (Fig. 8). Then recheck the flame signal.
2. If there is still no flame signal, replace the plug-in amplifier.
3. If you still cannot obtain a meter reading, replace the entire C7915A Infrared Flame Detector.

IMPORTANT:

At the completion of troubleshooting, be sure to perform the Adjustments and Checkout, page 10.

SERVICE



CAUTION

Fire and Explosion Hazard. Only use qualified service technicians to attempt to service or repair flame safeguard controls and burner systems.

Open the master switch to disconnect power before removing or installing the detector.

If the C7915A is disassembled for any reason (e.g., to replace the lead sulfide cell or bushing with focusing lens), you must perform the Adjustments and Checkout, page 10.

PERIODIC MAINTENANCE

1. Clean the focusing lens and sight pipe when necessary. Remove the detector and use a soft, clean cloth. The lens does not require removal to clean it. If it is broken or damaged, or it is coated with a substance that cannot be cleaned off, replace the 50019469-001 Bushing, which includes the focusing lens.
2. Keep the flame detection system adjusted for the smoothest, most reliable operation as recommended by the burner manufacturer.
3. Replace the bushing with focusing lens or the lead sulfide photocell (Fig. 8) *only when necessary to obtain proper operation.*

Automation and Control Solutions

Honeywell International Inc.
1985 Douglas Drive North
Golden Valley, MN 55422
customer.honeywell.com

Honeywell