



MUSTEE

Elegance ■ Innovation ■ Durability



Welcome! E. L. Mustee & Sons, Inc. manufactures products designed to add luxury, convenience, functionality and greater livability to your home. Here you'll find products that present unique design options whether your plans are for building new or remodeling.

Mustee also offers many quality products for commercial, institutional and industrial applications.

Since 1932, Mustee brand products have stood for the best in quality, design, innovation and durability. We invite you to discover what decades of customers already know about Mustee products...they look great, and last.

TABLE OF CONTENTS

- 2-3.) TOPAZ™ Fiberglass Bathtubs
- 4-7.) DURAWALL®, DURABASE® & STYLEMATE® Shower Ensembles
- 8-11.) DURAWALL® & VARISTONE™ Shower Walls
- 12-13.) DURABASE® Shower Floors
- 14.) STYLEMATE® Shower Enclosures
- 15-17.) CareGiver® ADA Easy-Access Showers & SHOWERTUB™ Shower Floors
- 18-19.) CareGiver® Grab Bars & Fold-Down Seats
- 20-21.) Vector™ & Utility Sinks
- 22-25.) UTILATUB®, UTILATUB® Combo, UTILATWIN®, DURATUB® Laundry Tubs, BIGTUB™, Lil'TUB™ Utility Tub & Accessories
- 26-27.) UTILATUB® & UTILATWIN® Combo Laundry Tubs
- 28.) DURAPAN™ Washer & Water Heater Pans
- 29.) DURASTALL® Shower Stalls
- 30-33.) TOPAZ™, VARISTONE™, DURAWALL® Bathtub Walls & DURATRIM™ Window Kits
- 34-35.) Mop Service Basins & Accessories

COMPANY PROFILE



mil Lawrence Mustee would be proud. The company he founded in 1932 to produce "side arm" water heaters, hot plates and incinerators, has grown to become a category leader in many of the product lines it produces.

When it came to his business, E. L. Mustee insisted that any product bearing his name must deliver the highest quality and service life. We are proud to state that our founder's passion for quality, functionality and dependability is a part of every product that leaves our plants and warehouses.

Much has changed in the E. L. Mustee & Sons, Inc. product line which testifies to the company's ability to envision new product designs or enhancements to existing products. The company's expertise for molding fiberglass, thermoplastics and other materials has driven Mustee's product line growth and diversification.

E. L. Mustee & Sons' quality, innovation, durability and performance serves countless loyal customers in the residential, commercial, healthcare, institutional and industrial markets.

TOPAZ™ FIBERGLASS BATHTUBS



TOPAZ™ FIBERGLASS BATHTUBS

TOPAZ™ premium fiberglass bathtubs bring together classic design, exceptional features, premium construction and of course, legendary E. L. Mustee & Sons quality. Besides offering the state-of-the-art in bathtub design & construction, TOPAZ™ bathtubs are the perfect way to create a look of elegance in any bathtub alcove you are planning to create.

Companion Products

- TOPAZ™ bathtubs and TOPAZ™ 660 direct-to-stud wall systems (page 31) can be easily combined to create a handsome 4-piece bathtub and wall ensemble
- TOPAZ™ bathtubs can also be used with any DURAWALL® or VARISTONE™ adhesive-mount wall system (pages 10, 30-33) and tile.

TOPAZ™ FIBERGLASS BATHTUBS

Features

- Precision molded from Mustee's premium VARISTONE™ fiberglass
- Apron supported by 2 molded fiberglass brackets
- Structural ribbed bottom and sides to prevent sagging
- Ergonomically contoured back with a 40° lumbar slope
- Proprietary finish creates a deep, long lasting shine and scratch-resistant surface
- Slip-resistant bottom surface
- One piece molded, with matched metal molds
- Fits standard 30" x 60" alcove
- Available right hand & left hand with an 8½" x 14¼" drain offset
- Suitable for use with all popular finished wall treatments
- Easy to clean

Code Accepted

TOPAZ™ Bathtubs meet or exceed performance requirements:

- International Association of Plumbing and Mechanical Officials (IAPMO®) 
- American National Standards Institute (ANSI)  – Specification Z 124-2011



See Bathtub Walls: Pages 30-31

Specifications

T6030 TOPAZ™ Fiberglass Bathtubs



Model	Color	Description
T6030L	White	30" x 60" Bathtub, Left hand drain
T6030LBN	Bone	30" x 60" Bathtub, Left hand drain
T6030LBT	Biscuit	30" x 60" Bathtub, Left hand drain
T6030R	White	30" x 60" Bathtub, Right hand drain
T6030RBN	Bone	30" x 60" Bathtub, Right hand drain
T6030RBT	Biscuit	30" x 60" Bathtub, Right hand drain

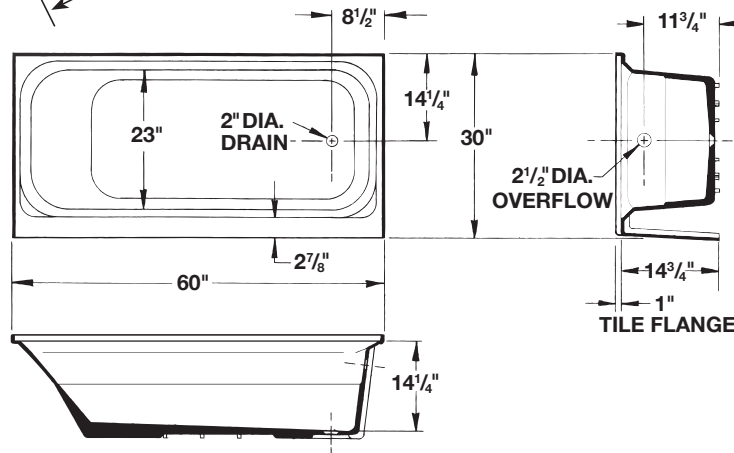

General: Furnish and install as shown on plans, E. L. Mustee & Sons, Inc. TOPAZ™ Fiberglass Bathtub 30" x 60" right or left-handed Model: _____. Construction shall be molded, reinforced fiberglass using matched metal molds under extreme heat and pressure. Shall meet ANSI Specification Z 124-2011. Color: _____ (White, Bone, Biscuit). Install in compliance with local codes.



DURAWALL®, DURABASE®, STYLEMATE® FIBERGLASS SHOWER ENSEMBLES

When looking for the perfect shower ensemble in your bathroom, choose the products "Preferred by the Pros" from E. L. Mustee & Sons.

DURAWALL® fiberglass wall systems, DURABASE® fiberglass shower floors, and STYLEMATE® enclosures are recognized for their universal design, high quality, innovative features, ease of installation, and durability.

From tile patterns to shelves, Mustee's DURAWALL®, DURABASE®, and STYLEMATE® products will help you create the bathroom you desire.



Tongue-and-groove fit



Direct to stud

Features

- DURAWALL® shower walls feature convenient direct-to-stud mounting, innovative leak-proof, tongue-and-groove panels
- DURAWALL® shower wall systems feature multiple, molded-in shelves and a deep gloss, mildew/stain-resistant finish
- DURABASE® floors feature a slip resistant Starburst® floor design and a ribbed underbody for strength & support. *See pages 12 and 13 for complete DURABASE® features*
- STYLEMATE® enclosures are available in numerous styles and configurations and utilize tempered safety glass. *See complete features on page 14*

Code Accepted

Fiberglass shower walls meet or exceed performance requirements:

- American Society of Testing and Materials (ASTM) D 635, E-84 and E-162
- American National Standards Institute (ANSI) Z 124-2011 and Z 97.1









Mustee's shower ensembles are packed in three to four cartons and easily carried through narrow hall/stairways. Installation can be done within a confined area by one person.

36" CORNER SHOWERS – Double Threshold



Specifications

Model	Color/Glass	UPC	Intertek
 DURAWALL® SHOWER WALL 736CWHT	White		
 DURABASE® SHOWER FLOOR 3636DTM	White		
 STYLEMATE® ENCLOSURE 36.202	Chrome/Clear		

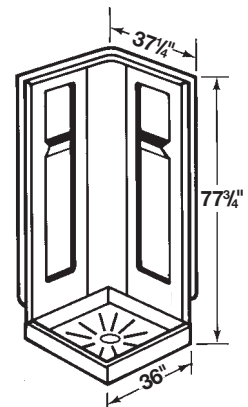
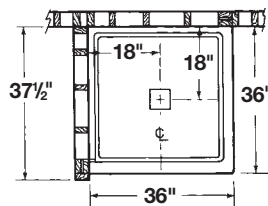

See page 5 for valve placement.

General: Furnish and install as shown on plans, a Corner Shower Ensemble, as manufactured by E. L. Mustee & Sons, Inc., consisting of:

DURAWALL® Shower Walls – Model 736CWHT shall be semi-gloss, 3-piece wall. Panels are molded fiberglass, using matched metal molds under extreme heat and pressure with a minimum uniform thickness of 125 mils and mount direct-to-studwalls. Include corner panel and two side panels with molded-in shelf. Self-aligning panels interlock using a tongue-and-groove connection. Shall meet ANSI Specification Z 124-2011. Color: White.

DURABASE® Shower Floor – Model 3636DTM, refer to page 13 for specifications.

STYLEMATE® Enclosure – Model 36.202, refer to page 14 for specifications.

SQUARE SHOWERS

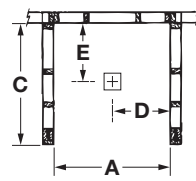

Shower Size

Shower Size	A	B	C	D	E	F
32" x 32"	32"	32"	33½"	16"	16"	33¼"
36" x 36"	36"	36"	37½"	18"	18"	37¼"

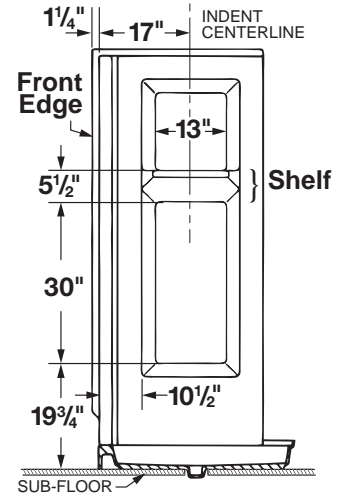
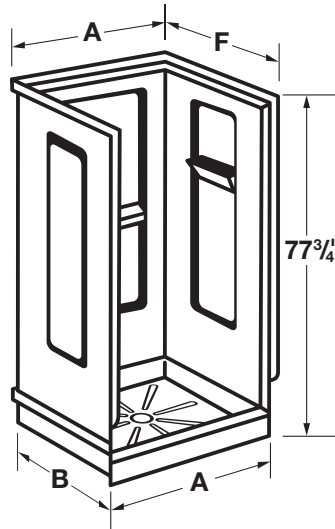

Valve Placement Dimensions

Specifications

32" x 32" Showers



Model	Color/Glass
DURAWALL® SHOWER WALLS 732WHT	White
732BN	Bone



Model	Color/Glass
DURABASE® SHOWER FLOOR 3232M	White
3232BN	Bone

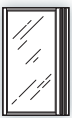

Model	Color/Glass
STYLEMATE® PIVOT DOOR – Height 65" 32.705	Chrome/Clear
32.706	Oil-Rubbed Bronze/Clear

36" x 36" Showers

Model	Color/Glass
DURAWALL® SHOWER WALLS 736WHT	White
736BN	Bone



Model	Color/Glass
DURABASE® SHOWER FLOOR 3636M	White
3636BN	Bone



Model	Color/Glass
STYLEMATE® PIVOT DOOR – Height 65" 36.403	Chrome/Clear
36.404	Oil-Rubbed Bronze/Clear

General: Furnish and install as shown on plans, a Shower Ensemble, as manufactured by E. L. Mustee & Sons, Inc., consisting of:

DURAWALL® Shower Walls – Model: _____ (732 or 736) shall be semi-gloss, 3-piece wall. Panels are molded fiberglass, using matched metal molds under extreme heat and pressure with a minimum uniform thickness of 125 mils and mount direct-to-studwalls. Include center panel with molded-in shelf and two side panels, each with molded-in shelf. Self-aligning panels using a tongue-and-groove connection. Shall meet ANSI Specification Z 124-2011. Color: _____ (White, Bone).

DURABASE® Shower Floors – Model: _____ refer to page 12 for specifications.

STYLEMATE® Pivot Door Enclosures – Model: _____ refer to page 14 for specifications.

RECTANGULAR SHOWERS

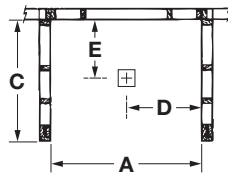

Shower Size	A	B	C	D	E	F
32" x 48"	48"	32"	33½"	24"	16"	33¼"
34" x 48"	48"	34"	35½"	24"	17"	35¼"

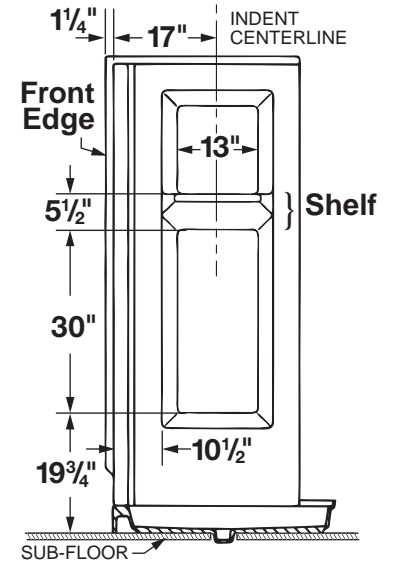
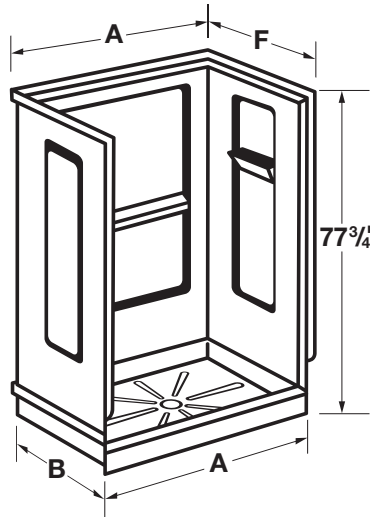

Valve Placement Dimensions

Specifications

32" x 48" Showers

Model **Color/Glass**

DURAWALL® SHOWER WALLS

748-32WHT

White



748-32BN

Bone

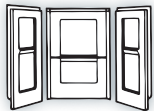

DURABASE® SHOWER FLOOR

3248M

White



3248BN

Bone



STYLEMATE® BY-PASS ENCLOSURE – Height 69"

Framed design

48.403

Chrome/Clear

48.404

Brushed Nickel/Clear

48.405

Oil-Rubbed Bronze/Clear

Frameless design

48.406

Chrome/Clear

48.407

Brushed Nickel/Clear

48.408

Oil-Rubbed Bronze/Clear

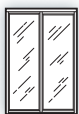

34" x 48" Showers

Model **Color/Glass**

DURAWALL® SHOWER WALLS

748-34WHT

White



748-34BN

Bone

DURABASE® SHOWER FLOOR

3448M

White



3448BN

Bone

STYLEMATE® BY-PASS ENCLOSURE – Height 69"

Framed design

48.403

Chrome/Clear

48.404

Brushed Nickel/Clear

48.405

Oil-Rubbed Bronze/Clear

Frameless design

48.406

Chrome/Clear

48.407

Brushed Nickel/Clear

48.408

Oil-Rubbed Bronze/Clear

General: Furnish and install as shown on plans, a Shower Ensemble, as manufactured by E. L. Mustee & Sons, Inc., consisting of:

DURAWALL® Shower Walls – Model: _____ (748-32 or 748-34) shall be semi-gloss, 3-piece wall. Panels are molded fiberglass, using matched metal molds under extreme heat and pressure with a minimum uniform thickness of 125 mils and mount direct-to-studwalls. Include center panel with molded-in shelf and two side panels, each with molded-in shelf. Self-aligning panels using a tongue-and-groove connection. Shall meet ANSI Specification Z 124-2011. Color: _____ (White, Bone).

DURABASE® Shower Floors – Model: _____ refer to page 12 for specifications.

STYLEMATE® By-Pass Enclosures – Model: _____ refer to page 14 for specifications.

NEO-ANGLE SHOWERS

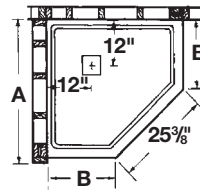

Shower Size	A	B	C
36"	37 1/2"	18"	37 1/4"
38"	39 1/2"	20"	39 1/4"
42"	43 1/2"	24"	43 1/4"

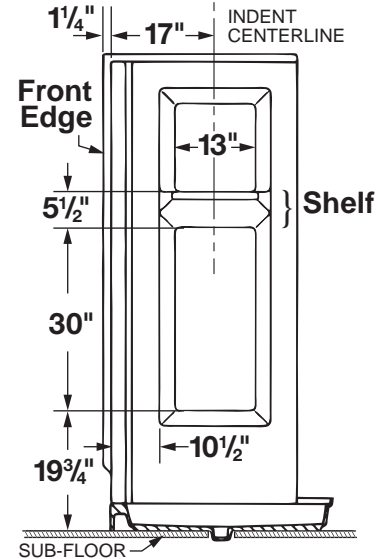
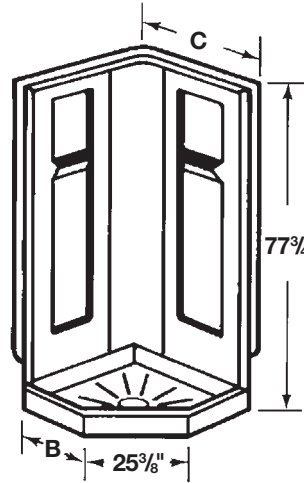

Valve Placement Dimensions

Specifications

36" Showers

Model Color/Glass



DURAWALL® SHOWER WALLS

736CWHT	White		
736CBN	Bone		

DURABASE® SHOWER FLOOR



3636CM	White		
3636CBN	Bone		



STYLEMATE® NEO-ANGLE ENCLOSURE — Height 70"

36.750	Chrome/Obscure
36.761	Chrome/Clear
36.762	Brushed Nickel/Clear
36.763	Oil-Rubbed Bronze/Clear

38" Showers

Model Color/Glass

DURAWALL® SHOWER WALLS

738CWHT	White		
---------	-------	--	--

DURABASE® SHOWER FLOOR

3838CM	White		
--------	-------	--	--

STYLEMATE® NEO-ANGLE ENCLOSURE — Height 70"

38.750	Chrome/Obscure
38.751	Chrome/Clear
38.752	Brushed Nickel/Clear
38.753	Oil-Rubbed Bronze/Clear

42" Showers

Model Color/Glass

DURAWALL® SHOWER WALLS

742CWHT	White		
742CBN	Bone		

DURABASE® SHOWER FLOOR

4242CM	White		
4242CBN	Bone		

STYLEMATE® NEO-ANGLE ENCLOSURE — Height 70"

42.750	Chrome/Obscure
42.751	Chrome/Clear
42.752	Brushed Nickel/Clear
42.753	Oil-Rubbed Bronze/Clear

General: Furnish and install as shown on plans, NEO-ANGLE Shower Ensembles, as manufactured by E. L. Mustee & Sons, Inc., consisting of:

DURAWALL® Shower Walls — Model: _____ (736C, 738C or 742C) shall be semi-gloss, 3-piece wall. Panels are molded fiberglass, using matched metal molds under extreme heat and pressure with a minimum uniform thickness of 125 mils and mount direct-to-studwalls. Include corner panel and two side panels with molded-in shelf. Self-aligning panels using a tongue-and-groove connection. Shall meet ANSI Specification Z 124-2011. Color: _____ (White, Bone).

DURABASE® Shower Floors — Model: _____ refer to page 13 for specifications.

STYLEMATE® NEO-ANGLE Enclosures — Model: _____ refer to page 14 for specifications.



Photo: ShowerTub™ shower floor and STYLEMATE® By-Pass Enclosure.

DURAWALL®, DURABASE®, STYLEMATE® FIBERGLASS SHOWER ENSEMBLES

Replace your standard 30"x60" bathtub with Mustee's popular 3060 Shower Tub™ or 360 Barrier-Free Shower floor. Then complete the installation with Mustee's stylish 760T-30WHT DURAWALL® shower walls. For 34" deep alcoves, use premium 760T-34WHT DURAWALL® Shower Walls.

The embossed tile pattern on the back and side panels of the premium 760T-30WHT and 760T-34WHT DURAWALL® shower walls deliver exceptional design features, deep glass finish, and Mustee's trademark quality construction.

Features

- Produced from high-grade, reinforced, molded fiberglass for optimum strength and impact resistance using matched metal molds under heat and pressure
- Embossed large-tile pattern on back and side panels
- Five-panel wall system with interlocking tongue-and-groove seams that assemble quickly to create a watertight wall surround
- Mounts direct-to-stud with mounting flanges hidden behind drywall or other wall treatment
- Available in white
- Smooth, colorfast deep gloss finish, resists scuffs.
- Mold and mildew-resistant, easy to clean
- Designed to support CareGiver® Grab Bars and Fold-Down Seats as needed

Accessories

572.300 VARISTONE™ – Shelves (Order Separately)

Order desired number of shelves separately. Sturdy shelf is easy to install. Carton is 12" x 7 1/4" x 4" and weighs 2.5 lbs.

These self-draining 12" x 7" shelves easily mount to the 760T-30 and 760T-34WHT shower wall at any location on the wall. Order multiple shelves to best meet your personal preference.

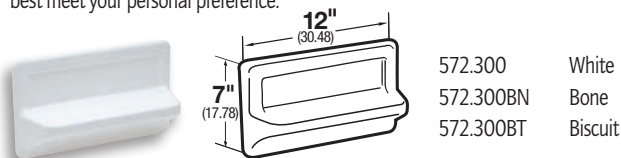

See page 10 for specifications.

CareGiver® – Safety Grab Bars (Order Separately)

CareGiver® Grab Bars are produced from high grade 18 gauge stainless steel tubing, then finished to a handsome, smooth satin finish. Strong, sturdy CareGiver® straight or angled Grab Bars are available in all popular sizes.



CAREGIVER® Grab Bars – See page 18 for specifications.

CareGiver® – Fold Down Shower Seats (Order Separately)

Mustee's CareGiver® line of wall-mounted and leg supported fold-down seats are available in two popular L-Shaped and Rectangular styles.

These premium quality seats offer the best in ample, comfortable shower seating along with exceptional design features and long life.



Specifications

30" x 60" Showers

Model Color/Glass



DURAWALL® SHOWER WALLS

760T-30WHT White



SHOWERTUB™ SHOWER FLOORS

3060R White  

3060L White

Drain locations: R = Right Hand L = Left Hand

STYLEMATE® BY-PASS ENCLOSURES

Framed design



60.403 Chrome/Clear
60.404 Brushed Nickel/Clear
60.405 Oil-Rubbed Bronze/Clear

Frameless design

60.406 Chrome/Clear
60.407 Brushed Nickel/Clear
60.408 Oil-Rubbed Bronze/Clear

DIRECT TO WALL STUD FEATURES



- Panels with tongue-and-groove seams.



- Reverse side of center panel has clips for securing to bathtub.



- 1 1/4" flanges fasten direct-to-stud walls with screws, drywall conceals flanges.

760T-30WHT

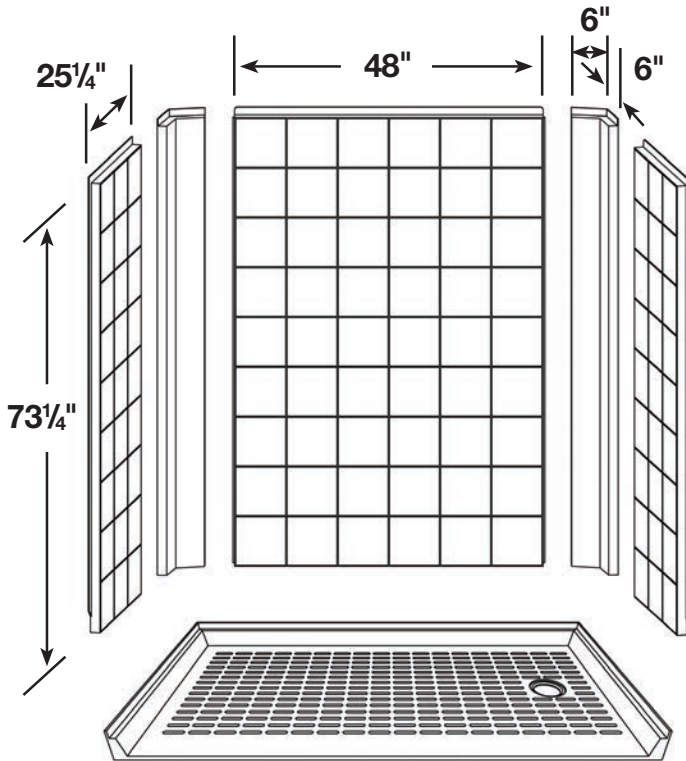

760T-34WHT

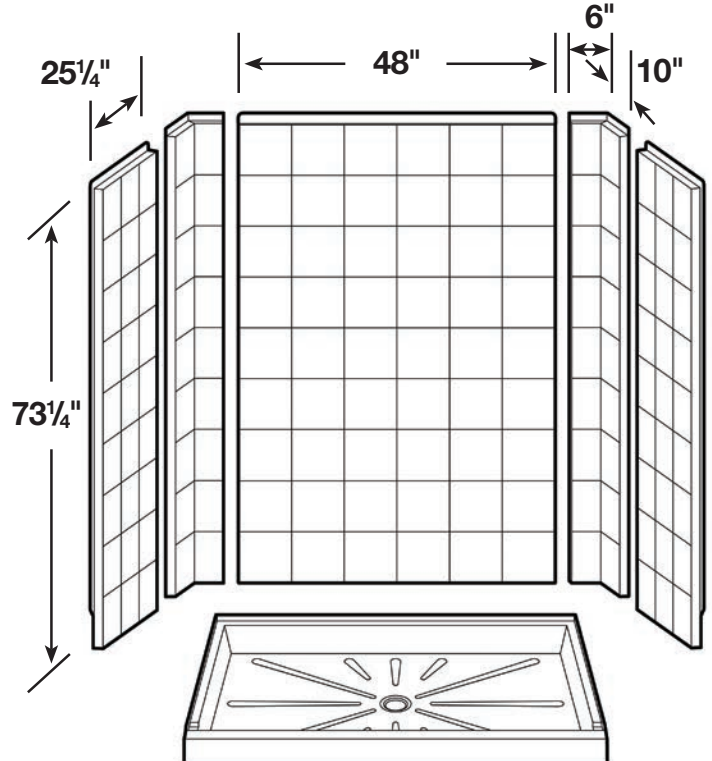

30" x 60" Showers Barrier-Free

Model **Color/Glass**



DURAWALL® SHOWER WALLS

760T-30WHT White

CAREGIVER® BARRIER-FREE SHOWER FLOORS

360R White

360L White



Drain locations: R = Right Hand L = Left Hand

ENTRY RAMP 12" x 60"

360.100 White

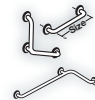

CAREGIVER® GRAB BARS

See page 16 for Grab Bar options.



CAREGIVER® FOLD-DOWN SHOWER SEAT

See page 17 for Fold-Down Seat options.



34" x 60" Showers

Model **Color/Glass**



DURAWALL® SHOWER WALLS

760T-34WHT White

DURABASE® SHOWER FLOORS



3460M White



STYLEMATE® BY-PASS ENCLOSURES

Framed design

60.403 Chrome/Clear
60.404 Brushed Nickel/Clear
60.405 Oil-Rubbed Bronze/Clear



Frameless design

60.406 Chrome/Clear
60.407 Brushed Nickel/Clear
60.408 Oil-Rubbed Bronze/Clear

General: Furnish and install as shown on plans, a Shower Ensemble, as manufactured by E. L. Mustee & Sons, Inc., consisting of:
DURAWALL® Shower Wall Model: _____ (760T-30WHT, 760T-34WHT). Shall be semi-gloss 5-piece wall. Panels are molded fiberglass, using matched metal molds under extreme heat and pressure with a minimum uniform thickness of 125 mils and mount direct-to-studwalls. Includes center panel and two corner and side panels. Self-aligning panels using an interlocking tongue-and-groove seam. Shall meet ANSI Specification Z 124-2011. Color: White.

SHOWERTUB™ Shower Floors – Model: _____ see page 16 for specifications.

CAREGIVER® Barrier-Free Shower Floors – Model: _____ see page 17 for specifications.

STYLEMATE® By-Pass Enclosures – Model: _____ see page 14 for specifications.

DURABASE® Shower Floors – Model: _____ see pages 16 & 15 for specifications.



572T VARISTONE™ SHOWER/BATHTUB FIBERGLASS WALLS

Mustee's VARISTONE™ premium fiberglass, Model 572T combines classic elegance, quality construction and easy installation to make it the preferred choice.

Model 572T walls with their distinctive embossed tile pattern, fit perfectly with Mustee's DURABASE™ shower floors and STYLEMATE™ shower enclosures. CareGiver™ grab bars and seats can be easily installed as well. Also fits perfectly with Mustee's TOPAZ™ bathtubs and other 30" x 60" and 32" x 60" bathtubs.

Features

- Embossed 8⁵/₈" x 9³/₄" tile pattern on side and back panels
- Seamless corner panels are overlapped by the side and back panel and create a high-quality, watertight wall system
- Adhesive-mounts to drywall or like surfaces
- Colorfast, mold and mildew-resistant finish
- Easily trimmed for out-of-plumb alcoves or to install DURATRIM™ window trim kits
- 5 panel, package...two corners, two side walls and one back panel
- Designed to fit a maximum alcove range up to 39" wide by 42" deep... or up to 60" wide and by 34" deep
- 12" x 7" VARISTONE™ shelves can be used to create handy storage
- Available in white, bone and biscuit



572.300 VARISTONE™ — Shelves (Order Separately)

572.300	White	Order desired number of shelves separately.
572.300BN	Bone	Sturdy shelf is easy to install. Carton is
572.300BT	Biscuit	12" x 7 ¹ / ₄ " x 4" and weighs 2.5 lbs.

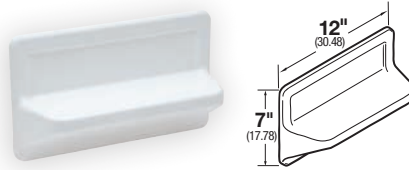

These self-draining 12" x 7" shelves easily mount to the shower wall at any location on the wall. Order multiple shelves to best meet your personal preference.

Code Accepted

VARISTONE™ Shower/Bathtub Walls meet or exceed performance requirements:

- American National Standards Institute (ANSI) – Specification Z 124-2011 

Specifications

572T VARISTONE™ — Shower/Bathtub Walls

Carton contains two side, one center, two corner panels and easy to follow, illustrated installation instructions. Carton is 7⁵/₈" x 32" x 76" and weighs 110 lbs.

Model Color

572TWH	White
572TBN	Bone

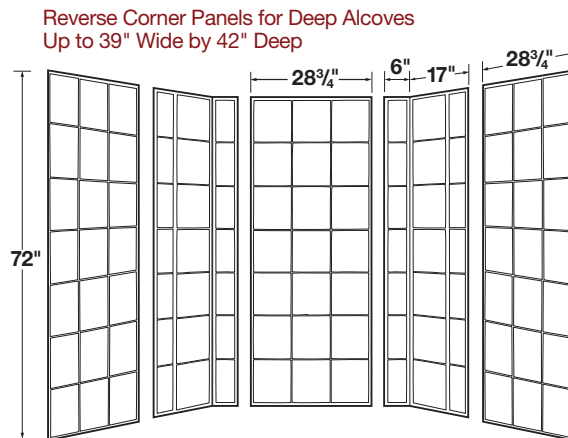
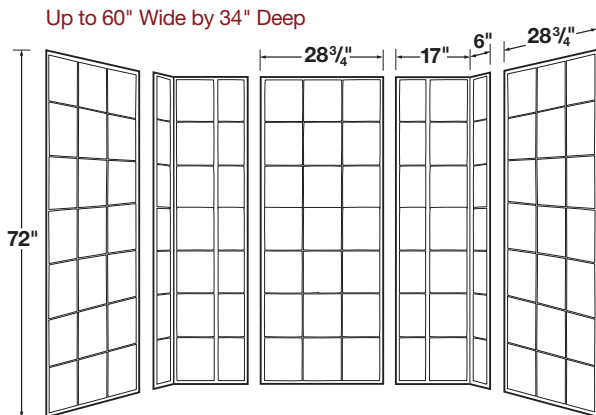

General: Furnish and install as shown on plans, fiberglass VARISTONE™ Shower/Bathtub Walls Model 572T as manufactured by E.L. Mustee & Sons, inc. Shall be semi-gloss, 5-piece wall system. Panels are molded using matched metal molds under extreme heat and pressure with a minimum thickness of 125 mils. Shall meet ANSI Specifications Z 124-2011 Colors: _____ (White, Bone)

DURAWALL® SHOWER WALLS

There's nothing like a new shower to dress up a bathroom and make the most of your available floor space. Whatever your plan, Mustee's Model 247, 260 and 265 square & rectangular shower wall systems and the Model 237 NEO-ANGLE/Corner Shower Wall System, give you the freedom to put your design ideas into motion.

Features

- High quality, thermoplastic construction
- Easily adhesive-mounts to drywall or like surfaces
- Six molded-in shelves...Models 247/260; three molded-in shelves...Model 237
- Available in color-fast white and bone
- High gloss, mold and mildew-resistant surface finish
- Trimmable flat panels
- Easily to install and clean
- Adjust for out-of-square walls

Specifications



247 DURAWALL® – Square and Rectangular

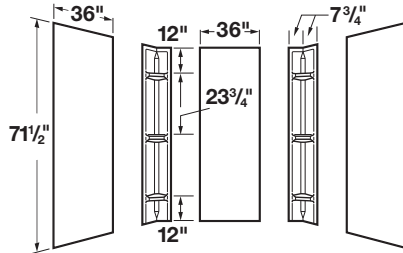

Model	Color	Width	Side	Shelves
247WHT	White	Up to 48"	Up to 42"	Six

General: Furnish and install as shown on plans, DURAWALL® Shower Wall Model 247 as manufactured by E. L. Mustee & Sons, Inc. Thermoplastic wall system shall be 5-piece construction with six formed shelves and overlapping corner panels. Uniform color throughout entire thickness of each panel. Color: White.



260 DURAWALL® – Square and Rectangular

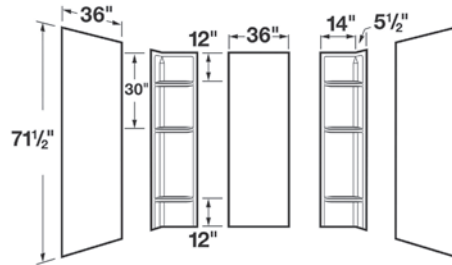

260WHT	White	Up to 60"	Up to 40"	Six
260BN	Bone	Up to 60"	Up to 40"	Six

General: Furnish and install as shown on plans, DURAWALL® Shower Wall Model 260 as manufactured by E. L. Mustee & Sons, Inc. Thermoplastic wall system shall be 5-piece construction with six formed shelves, seamless, overlapping corner panels. Uniform color throughout entire thickness of each panel. Color: _____ (White, Bone).



265 DURAWALL® – Square and Rectangular

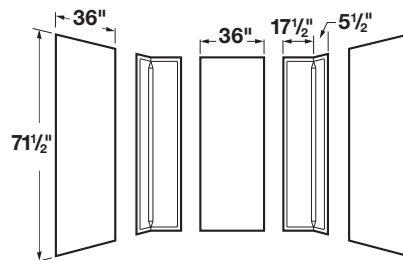

265WHT	White	Up to 71"	Up to 41 1/2"	
--------	-------	-----------	---------------	--

General: Furnish and install as shown on plans, DURAWALL® Shower Wall Model 265 as manufactured by E. L. Mustee & Sons, Inc. Thermoplastic wall system shall be 5-piece construction with seamless, overlapping corner panels. Uniform color throughout entire thickness of each panel. Color: White.



237 DURAWALL® – Neo-Angle/Corner

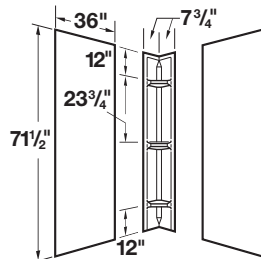

237WHT	White		Up to 42"	Three
237BN	Bone		Up to 42"	Three

General: Furnish and install as shown on plans, DURAWALL® Shower Wall Model 237 as manufactured by E. L. Mustee & Sons, Inc. Thermoplastic wall system shall be 3-piece construction with three formed shelves, seamless, overlapping corner panel. Uniform color throughout entire thickness of each panel. Color: _____ (White, Bone).



DURABASE® & SHOWERTUB™ FIBERGLASS SHOWER FLOORS

The strength of a quality shower begins with the floor. Mustee's line of DURABASE® shower floors are solid, stable, quality-constructed and exceed expectations.

Mustee's decades of fiberglass molding experience results in a handsome DURABASE® Square, Rectangle, Neo-Angle, and Corner units that will look great, provide great design options, as well as deliver years of dependable service.

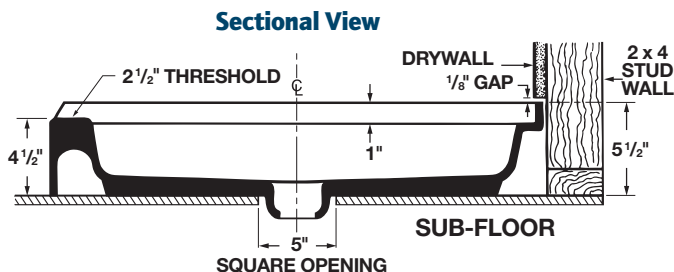

NEW

36" Deep Shower Floors **48" Square Shower Floor**

3642M – 36" x 42" 4848M – 48" x 48"

3648M – 36" x 48"

3660M – 36" x 60"

Specifications

Square – Single Threshold

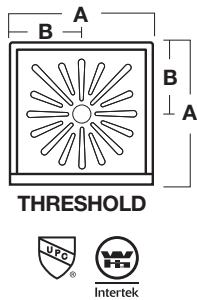

Nom. Size	Model	Colors	A	B
32" x 32"	3232M	White, Bone	32"	16"
34" x 34"	3434M	White	34"	17"
36" x 36"	3636M	White, Bone, Biscuit	36"	18"
42" x 42"	4242M	White	42"	21"
48" x 48"	4848M	White	48"	24"

When Ordering Color Models – include suffix BN for Bone or BT for Biscuit (eg. 4242CBN, 3448BT)

Rectangular – Single Threshold

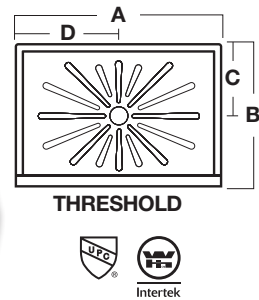

Nom. Size	Model	Colors	A	B	C	D
32" x 48"	3248M	White, Bone, Biscuit	48"	32"	16"	24"
32" x 54"	3254M	White	54"	32"	16"	27"
32" x 60"	3260M	White	60"	32"	16"	30"
34" x 42"	3442M	White, Bone, Biscuit	42"	34"	17"	21"
34" x 48"	3448M	White, Bone, Biscuit	48"	34"	17"	24"
34" x 54"	3454M	White, Bone	54"	34"	17"	27"
34" x 60"	3460M	White, Bone, Biscuit	60"	34"	17"	30"
36" x 42"	3642M	White	42"	36"	18"	21"
36" x 48"	3648M	White	48"	36"	18"	24"
36" x 60"	3660M	White	60"	36"	18"	30"
42" x 36"*	4236M	White	36"	42"	21"	18"

* Threshold on 36" side.

Model

Drain Seals – For DURABASE® Shower Floors

32.403	For 2" soil pipe/ser. wt.
32.404	For 2" copper pipe
32.405	For 1 1/2" ABS/PVC pipe

Showertub™ – Shower Floors

30" x 60"	3060L	White	60"	30"	15"	30"
30" x 60"	3060LBN	Bone	60"	30"	15"	30"
30" x 60"	3060R	White	60"	30"	15"	30"
30" x 60"	3060RBN	Bone	60"	30"	15"	30"

Drain location see page 16, drain not included

Features

- Study, one-piece compression molded fiberglass with structural underbody
- Integrally molded drain with seal and removable strainer, except Model 3060R/L
- Slip-resistant Starburst® floor design
- Designed for connection to pipe
- Available in all popular sizes for square, rectangular, NEO-ANGLE and corner units
- Engineered to fit all Mustee wall systems (See pages 4 through 11) as well as tile
- Mold and mildew-resistant surface, easy to clean

Code Accepted

DURABASE® and SHOWERTUB™ Shower Floors meet or exceed performance requirements:

- International Association of Plumbing and Mechanical Officials (IAPMO®)
- American National Standards Institute (ANSI) – Specification Z 124-2011
- Warnock Hersey® (Canada) Listed – CSA test standards: Shower Floor
- American Society of Testing and Materials (ASTM) – D 635 E-84 and E-162
- CAN/ULC S102-07 Burn and Smoke Test



General: Furnish and install as shown on plans, DURABASE® Shower Floor Model: _____, as manufactured by E. L. Mustee & Sons, Inc. Floor to be one-piece, molded fiberglass, made with matched metal molds. Surface to be slip-resistant Starburst® design that does not interfere with the flow of water. Size: _____" x _____". Shoulder will be no less than 3" high or less than 1" wide. Tiling flange will extend not less than 1" higher than the threshold which provides an integral molded water barrier. Threshold will be not less than 4½" high. Molded-in drain and drain seal for installation of 2" iron DWV (Sch. 40) PVC or ABS sanitary drain pipe. Removable strainer. Shall meet ANSI Specification Z 124-2011. Color: _____ (White, Bone, Biscuit).

Neo-Angle – Corner Threshold



Nom. Size	Model	Colors	A	B	C
36" x 36"	3636CM	White, Bone, Biscuit	36"	12"	18"
Center lines: 17½" x 24⅜" x 17½"					
38" x 38"	3838CM	White, Bone, Biscuit	38"	12"	20"
Center lines: 19½" x 24⅜" x 19½"					
42" x 42"	4242CM	White, Bone	42"	12"	24"
Ce 23½" x 24⅜" x 23½"					

Center line varies based upon thickness of side walls.

Corner – Double Threshold

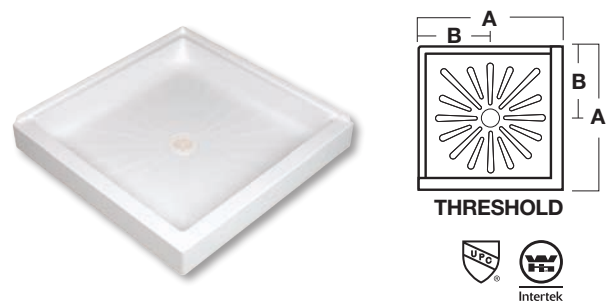

Nom. Size	Model	Colors	A	B
34" x 34"	3434DTM	White	34"	17"
36" x 36"	3636DTM	White	36"	18"

Strainers – For DURABASE® Shower Floors

34.301	Stainless steel
42.326	Plastic/Chrome Plated
42.327	Plastic/Gold Plated



GapSeal-Pro™ – For all shower floors and bathtubs

The flexible PVC GapSeal-Pro™ features a strong adhesive strip that allows it to be easily positioned to "extend" tile flange and effectively seal the gap between drywall or like-surfaces on shower floors or bathtubs. Patent pending.

Model	Size
60.320A	132" long x 2" tall



Scan to access more details.



STYLEMATE® SHOWER ENCLOSURES & DOORS

Looking for the best way to finish off your Mustee shower? That's easy...select one of our many decorative STYLEMATE® doors and enclosures to add that finishing touch.

Features

- Rolling doors include rollers with long-life bearings for years of smooth operation
- Chrome, brushed-nickel or oil-rubbed bronze frames are constructed from high-quality engineered aluminum
- Tempered safety glass options include clear or obscure glass
- Pivot doors feature magnetic catch
- Easy to install and clean



Chrome

Oil-Rubbed Bronze

Brushed Nickel

Code Accepted

STYLEMATE® Enclosures meet or exceed performance requirements:

- American National Standards Institute (ANSI) Specification Z 97.1 



Neo-Angle Door



By-Pass Framed Door



Pivot Door



By-Pass Frameless Door

Specifications

Pivot Doors – Height 65"

Model	Opening	Finish	Glass
32.705	29"-31"	Chrome	Clear
32.706	29"-31"	Oil-Rubbed Bronze	Clear
36.403	34"-35 1/2"	Chrome	Clear
36.404	34"-35 1/2"	Oil-Rubbed Bronze	Clear

General: Furnish and install as shown on plans, a STYLEMATE® Pivot Door, as manufactured by E. L. Mustee & Sons, Inc. Model: _____ shall be a swing style door with a bright _____ (Chrome, Oil-Rubbed Bronze) finish aluminum frame and clear tempered safety glass panel. Continuous-pull handle with magnetic seal. Out-of-plumb conditions up to 1" can be adjusted at latch jamb. Can be installed for right or left opening. Shall meet ANSI Specification Z 97.1.

By-Pass Doors – Height 69"

Framed design

48.403	47"	Chrome	Clear
48.404	47"	Brushed Nickel	Clear
48.405	47"	Oil-Rubbed Bronze	Clear

Frameless design

48.406	47"	Chrome	Clear
48.407	47"	Brushed Nickel	Clear
48.408	47"	Oil-Rubbed Bronze	Clear

Framed design

60.403	59"	Chrome	Clear
60.404	59"	Brushed Nickel	Clear
60.405	59"	Oil-Rubbed Bronze	Clear

Frameless design

60.406	59"	Chrome	Clear
60.407	59"	Brushed Nickel	Clear
60.408	59"	Oil-Rubbed Bronze	Clear

General: Furnish and install as shown on plans, a STYLEMATE® By-Pass Enclosure, as manufactured by E. L. Mustee & Sons, Inc. Model: _____ with bright _____ (Chrome, Brushed Nickel, Oil-Rubbed Bronze) finish. Shall be by-pass style with aluminum frame and clear tempered safety glass. Out-of-plumb conditions up to 1" can be adjusted. Shall meet ANSI Specification Z 97.1.

Neo-Angle Enclosures – Height 70"

Model	Fits	Finish	Glass
36.750	36" Neo	Chrome	Obscure
36.761	36" Neo	Chrome	Clear
36.762	36" Neo	Brushed Nickel	Clear
36.763	36" Neo	Oil-Rubbed Bronze	Clear
38.750	38" Neo	Chrome	Obscure
38.751	38" Neo	Chrome	Clear
38.752	38" Neo	Brushed Nickel	Clear
38.753	38" Neo	Oil-Rubbed Bronze	Clear
42.750	42" Neo	Chrome	Obscure
42.751	42" Neo	Chrome	Clear
42.752	42" Neo	Brushed Nickel	Clear
42.753	42" Neo	Oil-Rubbed Bronze	Clear

General: Furnish and install as shown on plans, NEO-ANGLE Shower Ensemble, as manufactured by E. L. Mustee & Sons, Inc., consisting of: STYLEMATE® Enclosure – Model: _____ with bright _____ (Chrome, Brushed Nickel, Oil-Rubbed Bronze) finish. Safety glass panels shall be obscure or clear. Side-wall jambs adjust 3/4" for out-of-plumb walls. Reversible pivot door with continuous-pull handle integrally extruded and magnetic seal. Door can be hung to open left or right. Shall meet ANSI Specification Z 97.1.



Double-Threshold Enclosures – Height 70"

36.202	36" DT	Chrome	Clear
--------	--------	--------	-------

General: Furnish and install as shown on plans, Double Threshold Shower Ensemble, as manufactured by E. L. Mustee & Sons, Inc., consisting of: STYLEMATE® Enclosure – Model 36.202 with bright Chrome finish aluminum frame. Safety glass panels shall be clear. Side-wall jambs adjust 3/4" for out-of-plumb walls. Reversible pivot door with continuous-pull handle integrally extruded and magnetic seal. Door can be hung to open left or right. Shall meet ANSI Specification Z 97.1.

3739 CareGiver® EASY-ACCESS SHOWER FLOORS



Transfer Shower Floor

The CareGiver® product line of Easy-Access Shower Floors provides quality-built, engineered solutions that enable safe, effortless shower access to those with limited or assisted mobility. Companion products include Fold-down Shower Seats and Grab Bars (See pages 18-19)

Features

- Slip-resistant surfaces...stain, mildew and mold resistant finish
- High quality molded fiberglass construction
- Uses standard 2" drain
- Available in white & bone matched finishes with Mustee wall systems (See pages 10-11)
- Easy to install and clean
- Meets ADA requirements as specified

ADA Accepted

- Americans with Disabilities Act (ADA)
- Code of Federal Regulations July 1, 1997 and July 1, 2007 (ADA)
- American Society of Testing & Materials (ASTM) D 635 Flammability, E-84 Flame Spread, E-162 Fire Retardancy



Accessories



- CareGiver® Safety Grab Bar Model 390.304



- CareGiver® Fold-Down Shower Seats Models 390.404 & 390.403



- Water Barrier Kit, Model 360.210



- DURAWALL® Shower Walls Models 572T, 260 & 265



- GapSeal-Pro™ Model 60.320A



Specifications



Transfer Shower Floor 37" x 39"

Model	Color	Drain
TRANSFER SHOWER FLOOR 3739M	White	Center Drain

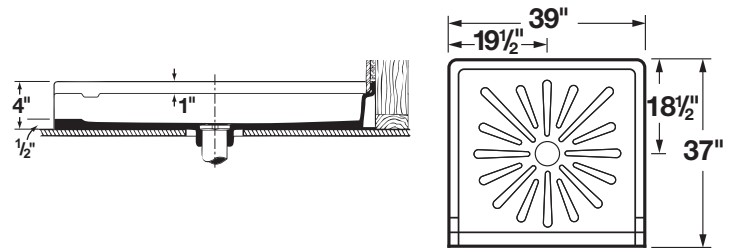

General: Furnish and install as shown on plans Transfer Shower Floor Model: _____, as manufactured by E. L. Mustee & Sons, Inc. Floor to be one piece, molded fiberglass made with matched metal molds. Surface to be slip-resistant Starburst® design that does not interfere with the flow of water. Size 37" x 39". Shoulder will be no less than 3" higher or less than 1" wide. Tiling flange will extend not less than 1" high to provide an integral water barrier. Threshold will be 1/2" high. Molded-in drain and drain seal for installation of 2" iron DWV (Sch. 40) PVC or ABS Sanitary drain pipe. Removable strainer. Shall meet ADA, ASTM D635, E-84 and D635, and Code of Federal Regulation July 1, 1997 and July 1, 2007. Color: White.

360.210 Continuous Water Barrier Kit

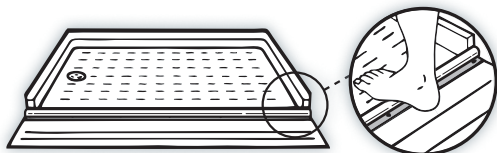

360.210 Continuous Water Barrier Kit – Creates an effective water barrier for the shower threshold that easily collapses for wheelchairs or walkers then instantly reforms to keep water from escaping. Length 67".

SHOWERTUB™ SHOWER FLOOR REPLACES 30" x 60" BATHTUB



Features

- Fits the same footprint as a standard 30" x 60" bathtub
- High quality molded fiberglass construction
- Drain location offset 8½" x 15"; right and left-hand models
- Accommodates standard 2" drain or 60.300 Drain Kit
- Available in white and bone matched finishes with Mustee wall systems, see pages 8, 10, & 11; as well as tile or like finish

Code Accepted

Mustee Easy Access Showers meet or exceed performance requirements as listed:

- IAMPO® Listed
- American Society of Testing and Materials (ASTM) – D.635, E-84 and E-162 Fire Retardancy
- American National Standards Institute (ANSI) Specification Z 124-2011
- Inhalation Toxicity Test



Accessories



■ CareGiver® Safety Grab Bar Model 390.304



■ CareGiver® Fold-Down Shower Seats Models 390.413



■ DURAWALL® Shower Walls; 572T, 760T-30WHT, 260 & 265



■ StyleMate® Enclosures See page 14 for Framed & Frameless models

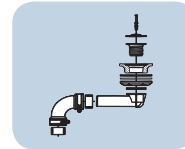

■ Drain Assemblies: 60.300A, 60.300BN



■ GapSeal-Pro™ Model 60.320A

Specifications

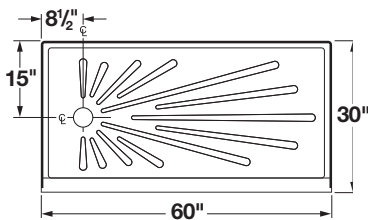

Model	Color	Drain
3060R	White	Right Hand
3060RBN	Bone	Right Hand
3060L	White	Left Hand
3060LBN	Bone	Left Hand

General: Furnish and install as shown on plans, ShowerTub™ Model: _____ as manufactured by E. L. Mustee & Sons, Inc. Floor to be one-piece, molded fiberglass, using matched metal molds under extreme heat and pressure. Surface to be slip-resistant design that does not interfere with flow of water. Size: 30" x 60". Flood level rim will not be less than 3" high. Tiling flange will extend not less than 1" higher than the threshold which is an integral molded water barrier. Threshold will be 4½" high. Drain hole offset 8½" by 15" to accept drain kit for 2" PVC, ABS or iron DWV pipe, available left or right hand. Color: _____ (White, Bone).

3060, 360 & 3865 Shower Floor Drains

Drain Assembly – for 2" DWV Pipe

Model	Description
42.317A	Drain assembly

Drain Seal

42.320	Optional drain seal for 2" copper (DWV)
42.321	Optional drain seal for 2" soil pipe (SW)

Drain Assembly – use with 3060R/L and 360R/L to replace tub waste and connect to existing pipe.

Model	Color
60.300A	White
60.300ABN	Bone

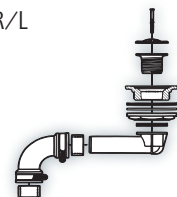

360 & 3865 BARRIER-FREE SHOWER FLOORS



Barrier-Free Shower Floor 30" x 60" and Entry Ramp 12" x 60"

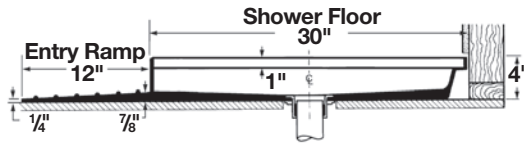
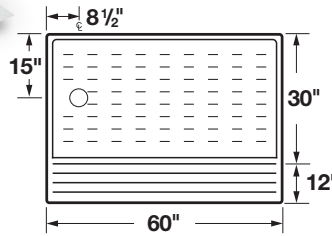

The CareGiver® product line of Easy-Access Shower Floors provides quality-built, engineered solutions that enable safe, effortless shower access to those with limited or assisted mobility.

Features

- Produced from high-grade, reinforced, molded fiberglass
- Ideal for new or remodel projects...fits several DURAWALL® Shower Walls as well as ceramic tile or preformed wall kit
- Replaces standard 30" deep by 60" wide bathtubs
- Slip resistant surface...stain, mildew and mold-resistant finish
- Optional drain kits are available; LH or RH drain location (see page 16)

BARRIER-FREE SHOWER FLOOR

360R	White	Right Hand
360RBN	Bone	Right Hand
360L	White	Left Hand
360LBN	Bone	Left Hand

ENTRY RAMP

360.100	White
360.100BN	Bone

General: Furnish and install as shown on plans DURABASE® Shower Floor Model: _____, as manufactured by E. L. Mustee & Sons, Inc. Floor to be one piece, molded fiberglass made with matched metal molds. Surface to be slip-resistant that does not interfere with the flow of water. Size 30" x 60". Shoulder will be no less than 3" higher or less than 1" wide. Tiling flange will extend not less than 1" high to provide an integral water barrier. Shall meet ADA, ASTM D635, E-84 and D635, and Code of Federal Regulation July 1, 1997. Color: _____ (White, Bone).

360.100 Entry Ramp — Furnish and install as shown on plans DURABASE® Shower Floor Entry Ramp Model: _____, as manufactured by E. L. Mustee & Sons, Inc. Ramp to be one piece, molded fiberglass made with matched metal molds. Size 12" x 60". Color: _____ (White, Bone).



Barrier-Free Shower Floor 38" x 65" and Entry Ramp 12" x 60"

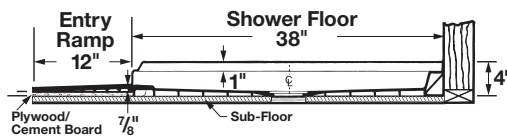
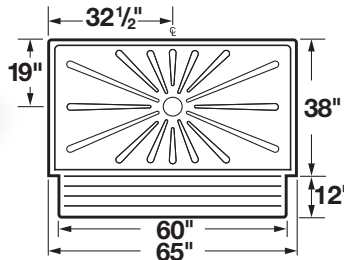

Features

- Produced from high-grade, reinforced, molded fiberglass
- Ideal for new or remodel projects
- Fits 65" wide by 38" deep alcove
- Slip resistant surface...stain, mildew and mold-resistant finish
- Meets ADA requirements for a full 36" turning circle
- Suggest 42.317A drain assembly
- Optional drain kits also available (see page 16)



BARRIER-FREE SHOWER FLOOR

3865	White	Center Drain
------	-------	--------------

ENTRY RAMP

360.100	White
---------	-------

General: Furnish and install as shown on plans Barrier-Free Shower Floor Model 3865, as manufactured by E. L. Mustee & Sons, Inc. Floor to be one piece, molded fiberglass made with matched metal molds. Surface to be slip-resistant Starburst® design that does not interfere with the flow of water. Size 38" x 65". Shoulder will be no less than 3" higher or less than 1" wide. Tiling flange will extend not less than 1" high to provide an integral water barrier. Threshold will be 1/2" high. Shall meet ADA, ASTM D635, E-84 and D635, and Code of Federal Regulation July 1, 1997 and July 1, 2007. Color: White.

360.100 Entry Ramp — Furnish and install as shown on plans DURABASE® Shower Floor Entry Ramp Model: 360.100, as manufactured by E. L. Mustee & Sons, Inc. Ramp to be one piece, molded fiberglass made with matched metal molds. Size 12" x 60". Color: White.

Accessories



- CareGiver® Safety Grab Bar Model 390.304



- CareGiver® Fold-Down Shower Seats



- DURAWALL® Shower Walls; 572T, 760T-30WHT, 260 & 265

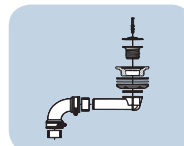

- Drain Assemblies: 60.300A, 60.300BN



- GapSeal-Pro™ Model 60.320A



- Continuous Water Barrier Kit; 360.210

CAREGIVER® SAFETY GRAB BARS

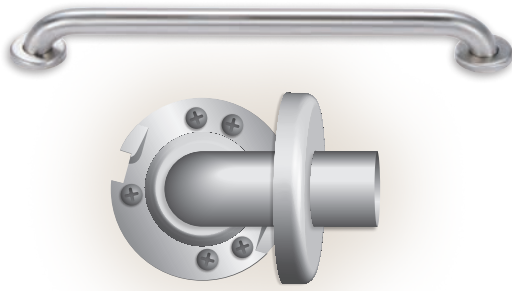

TWIST-LOCK CONCEALED FLANGE — locking tabs on the flange cover plate. Turn 15 degrees under the matching wedges on the mounting flange.

GRAB BARS — stainless steel, concealed twist-lock flanges, smooth finish

Grab bars benefit those needing extra stability and support when showering. What is not so readily obvious is the difference in quality from one make to another. Mustee's reputation for excellence in both design features and quality, make the company's CareGiver® line of Grab Bars the preferred choice of both healthcare professionals and home owners alike.

Featuring exceptional strength and rigidity, CareGiver® grab bars are manufactured to meet or exceed the most stringent industry and government requirements. Produced from heavy gauge stainless steel, Mustee's straight or angled Grab Bars truly are the industry standard for quality, features, performance and dependability.

Features

- Smooth stainless steel, 18-gauge tubing, satin finish, 1 1/2" diameter
- Exclusive "Twist-Lock" concealed flange-snaps into place for a secure, tamper-proof mounting
- All bars have a nominal offset distance of 1 1/2" (38 mm)
- Bar can't separate from flange
- Flat contact surface won't cut wall surfaces – bar remains stable without further tightening
- 304 Stainless steel mounting flange 14 gauge
- Tested to withstand 500 lbs. of downward load when properly installed
- Meets or exceeds HUD, FHA, VA, ADA and other Federal/Local codes

1 1/2" Straight

Size	Model
18" 457 mm	390.305
24" 610 mm	390.301
36" 915 mm	390.306
42" 1067 mm	390.307
48" 1220 mm	390.302

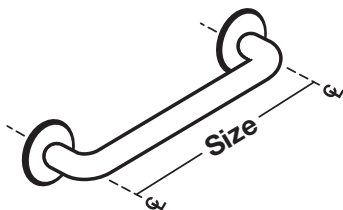

1 1/2" Angled

	A – Size – B	C	Model
	24" 610 mm 16" 430 mm	90°	390.308
	32" 813 mm 16" 430 mm	90°	390.309
	24" 610 mm 16" 430 mm	90°	390.310
	32" 813 mm 16" 430 mm	90°	390.311
	30" 762 mm 16" 430 mm	90°	390.312
	12" 305 mm No Corner Flange	120°	390.313
	16" 430 mm 16" 430 mm	120°	390.314
	24" 610 mm 16" 430 mm	120°	390.315

Inside Corner Styles

	34" 863 mm 18" 457 mm	90°	390.304
	42" 1067 mm 20" 508 mm	90°	390.303

General: Furnish and install as shown on plans, Straight Safety Grab Bar Model: _____, as provided by E. L. Mustee & Sons, Inc. Grab bar with Twist-Lock concealed flange shall be 1 1/2" diameter, 18 gauge, type 304 satin-finish stainless steel tubing. 14-gauge stainless steel mounting flange shall be Heliarc welded to the tube to form a single structural unit. Grab bar shall comply with applicable building codes. Meets ANSI A117.1.

General: Furnish and install as shown on plans, Angled Safety Grab Bar Model: _____, as provided by E. L. Mustee & Sons, Inc. Grab bar with Twist-Lock concealed flange shall be 1 1/2" diameter, 18 gauge, type 304 satin-finish stainless steel tubing. 14-gauge stainless steel mounting flange shall be Heliarc welded to the tube to form a single structural unit. Grab bar shall comply with applicable building codes. Meets ANSI A117.1.

CAREGIVER® FOLD-DOWN SEATS



Strong, sturdy and quality built, Mustee offers the most popular seat configurations and styles in both self-supporting and seats with legs.

Besides being a necessity for those who are unsteady on their feet and require assistance in the shower, many others enjoy Mustee premium fold-down shower seats for the convenience and comfort.

CareGiver® fold-down seats are the ideal solution for creating a comfortable and sturdy sit space in showers of all types.



Features

- Popular sizes and shapes
- Fire and mildew resistant
- When properly installed, wall-mount units can support up to 400 lbs., and leg-supported units can support up to 400 lbs.
- White cushion filled with high-resilience, high-density foam to maintain original shape
- Smooth cushion edges without corded piping – eliminates discomfort for pressure-sensitive bathers
- Rust-resistant stainless steel hardware
- Easy to install & clean – stain-resistant surface

Left-Hand Seat – Wall Mount

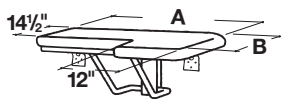

Size (A x B)	Model
26" x 21"	390.402
32" x 21"	390.404

Right-Hand Seat – Wall Mount

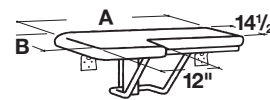

Size (A x B)	Model
26" x 21"	390.401
32" x 21"	390.403

Left-Hand Seat – With Legs

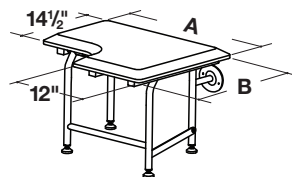

26" x 21"	390.405
32" x 21"	390.406

Right-Hand Seat – With Legs

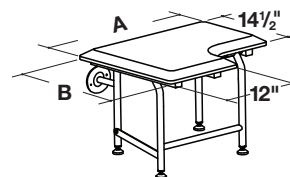

26" x 21"	390.407
32" x 21"	390.408

Rectangular Seat – Wall Mount

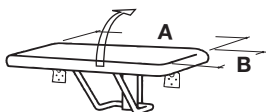

23" x 14 1/2"	390.413
26" x 14 1/2"	390.409
32" x 14 1/2"	390.410

Rectangular Seat – With Legs

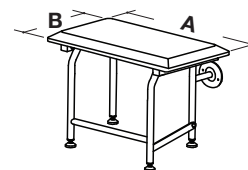

26" x 14 1/2"	390.411
32" x 14 1/2"	390.412

WALL MOUNTED UNITS:

General: Furnish and install as shown on plans, Fold-down Wall Mounted Shower Seat Model: _____, as provided by E. L. Mustee & Sons, Inc. Shower seat tubing shall be one-inch diameter, 18 gauge, type 304 stainless steel with #4 satin finish. Mounting brackets shall be 12-gauge type 304 stainless steel. Padded vinyl cushion shall have 1 1/2" high density, high-resilience foam, covered with fire and mildew resistant, UV inhibited, marine-grade Naugahyde. White cushion shall have no external piping. Shower seat unit shall comply with applicable building codes. Meets ANSI A117.1.

LEG SUPPORTED UNITS:

General: Furnish and install as shown on plans, Fold-down Leg-Supported Shower Seat Model: _____, as provided by E. L. Mustee & Sons, Inc. Shower seat tubing shall be one-inch diameter, 18 gauge, type 304 stainless steel with #4 satin finish. Shall include a fold-down mechanism with four support legs. Mounting brackets shall be 12-gauge type 304 stainless steel. Padded vinyl cushion shall have 1 1/2" high density, high-resilience foam, covered with fire and mildew resistant, UV inhibited, marine-grade Naugahyde. White cushion shall have no external piping. Shower seat unit shall comply with applicable building codes. Meets ANSI A117.1.



Model 25 VECTOR™ Multi-Task Sink

UTILITY FIBERGLASS SINKS

The new generation of Mustee Utility Sinks are not just for laundry rooms anymore. It's easy to envision these great looking sinks in craft or work rooms or at home bars.

Features

- Molded fiberglass construction
- Self-rimming, easy to install and clean
- Stain-resistant, colorfast surface finish
- Multiple pilot holes to install single or dual handle faucet with 4" or 8" center, soap dispensers or sprayers

Code Accepted

Utility Sinks meet or exceed performance requirements:

- International Association of Plumbing and Mechanical Officials (IAPMO®)
- Warnock Hersey® (Canada) – meets CSA #B45.0 and B.45.5
- American National Standards Institute (ANSI) – Specification Z 124-2011



Specifications

25 VECTOR™ Multi-Task Sink – Includes 1½" Drain for 1½" P-Trap with Stopper

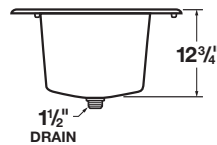
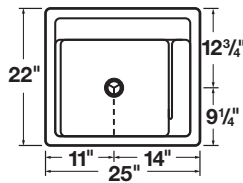

12-Gallon Capacity

Dimensions	LxWxD*	Model	Color
Overall	22" x 25" x 12¾"	25	White
Inside (top)	15½" x 22"	25BT	Biscuit
Inside (shelf)	15½" x 3⅛"	25TW	Twilight
Cutout	21" x 24"	25PD	Prairie Drift

Optional Utility Rack – Model 25.300

Overall	14½" x 21"	25.300	White
---------	------------	--------	-------

25 Vector Colors (check for availability)

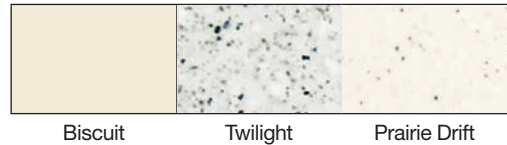

General: Furnish and install as shown on plans, a Countertop Sink Model 25 as manufactured by E. L. Mustee & Sons, Inc. Material composition shall be molded fiberglass, using matched metal molds under extreme heat and pressure. One-piece, seamless construction with self-rimming edge and complete 1½" drain assembly. Shall meet ANSI Specification Z 124-2011 Overall size 22" length x 25" width x 12¾" depth, weight 16 lbs. Color: _____ (White, Biscuit, Twilight, Prairie Drift).

2218 Undermount or Top Mount Sink – 3½" Opening



New versatile mounted utility sink. This great looking, quality sink can be either undermounted or top mounted.

Dimensions	LxWxD*
Overall	18" x 22" x 11"
Inside	14" x 17" x 10½"

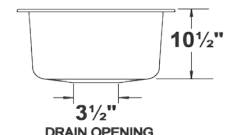
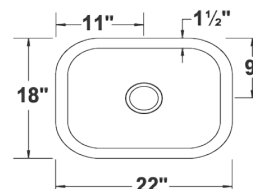

General: Furnish and install as shown on plans, an Undermount sink Model 2218 as manufactured by E. L. Mustee & Sons, Inc. Material composition shall be molded fiberglass, using matched metal molds under extreme heat and pressure. One-piece, seamless construction with self-rimming edge for undermount or top mount installation. Shall meet ANSI Specification Z 124-2011 Overall size 18" length x 22" width x 11" depth, weight 16 lbs. Color: White.

* L=Length (front to back) W=Width (left to right) D=Depth

Sinks continue on next page.



10 Utility Sink – Includes 1½" Drain for 1½" P-Trap, with Stopper

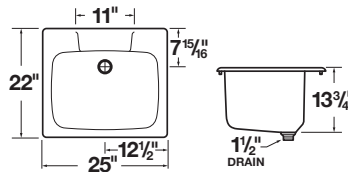

Dimensions LxWxD*	
Overall	22" x 25" x 13¾"
Inside Bowl	15¾" x 21¾" x 13¾"
Cutout	21" x 24"

Model	Color
10	White
10BN	Bone
17-Gallon Capacity	

General: Furnish and install as shown on plans, a Countertop Sink Model 10 as manufactured by E. L. Mustee & Sons, Inc. Shall be molded fiberglass, using matched metal molds under extreme heat and pressure. One-piece molded construction with self-rimming edge. Complete drain assembly. Overall size: 22" x 25" x 13¾". Shall meet ANSI Specification Z 124-2011. Color: _____ (White, Bone).



11 Utility Sink – 3½" Opening

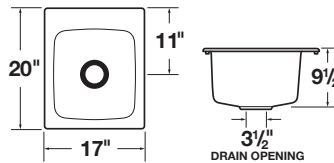

Overall	20" x 17" x 10"
Inside Bowl	15" x 14" x 9½"
Cutout	18½" x 15½"

Model	Color
11	White
11BN	Bone
11BT	Biscuit
7-Gallon Capacity	

General: Furnish and install as shown on plans, a Countertop Sink Model 11 as manufactured by E. L. Mustee & Sons, Inc. Material composition shall be molded fiberglass, using matched metal molds under extreme heat and pressure. One-piece seamless construction with self-rimming edge. 3½" drain opening. Overall size: 20" x 17" x 10". Shall meet ANSI Specification Z 124-2011. Color: _____ (White, Bone, Biscuit).



20 Bar Sink – 3½" Opening

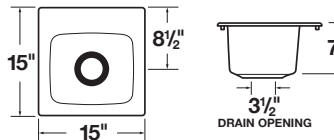

Overall	15" x 15" x 7¾"
Inside Bowl	10" x 12" x 7"
Cutout	13½" x 13½"

Model	Color
20	White
20BN	Bone
20BT	Biscuit
20SG	Sage

Available Sink Colors (check for availability)



Bone Biscuit Sage

3-Gallon Capacity

General: Furnish and install as shown on plans, a Countertop Sink Model 20 as manufactured by E. L. Mustee & Sons, Inc. Shall be molded fiberglass, using matched metal molds under extreme heat and pressure. One-piece construction with self-rimming edge. 3½" drain opening. Overall size: 15" x 15" x 7¾". Shall meet ANSI Specification Z 124-2011. Color: _____ (White, Bone, Biscuit, Sage).



10C Utility Sink – 3½" Opening

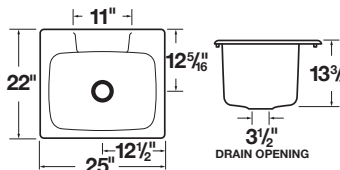

Overall	22" x 25" x 13¾"
Inside Bowl	15¾" x 21¾" x 13¾"
Cutout	21" x 24"

Model	Color
10C	White
10CBT	Biscuit
17-Gallon Capacity	

General: Furnish and install as shown on plans, a Countertop Sink Model 10C as manufactured by E. L. Mustee & Sons, Inc. Shall be molded fiberglass, using matched metal molds under extreme heat and pressure. One-piece molded construction with self-rimming edge. 3½" drain opening. Overall size: 22" x 25" x 13¾". Shall meet ANSI Specification Z 124-2011. Color: _____ (White, Biscuit).

UTILATUB® & UTILATWIN® LAUNDRY TUBS

Without question, the standard of excellence in single and double bowl laundry tubs is UTILATUB® and UTILATWIN®...exclusively from E. L. Mustee & Sons, Inc.

Decades of continual product innovation and development have positioned the very popular UTILATUB® and UTILATWIN® laundry/utility tubs as the brand the pro's specify and install for the best in sizing/selection, features, quality construction and most importantly, user satisfaction.

Mustee tubs are molded using premier DURASTONE® structural fiberglass and Co-PolyPure™ polypropylene. There's a size and style to fit in virtually any setting from the smallest home to the largest commercial installation.

Features

- Extra deep tubs help retain water...capacities range from 18 to 23 gallons per bowl
- High strength, impact resistant construction
- All models hook up to standard 1½" P-Trap
- Floor-mount models feature heavy gauge steel legs with self-levelers
- Wall-mount models feature a heavy gauge steel mounting bracket and hardware
- Stain and mildew-resistant surface, easy to clean
- Twin drain assembly included with all UTILATWIN® models

Specifications

Premier Thermoplastic Laundry Tubs

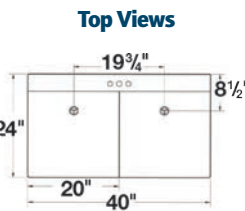
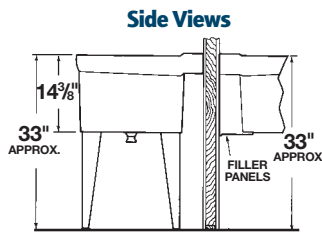

Model	Mount	Length*	Width*
27F/W UTILATWIN® LAUNDRY TUB			
27F	Floor	24"	40"
27W	Wall	24"	40"
38-Gallon Capacity			



General: Furnish and install as shown on plans, UTILATWIN® Laundry/Utility Tub Model: _____ (27F, 27W), as manufactured by E. L. Mustee & Sons, Inc. Unit shall be one-piece molded construction using cellular structural thermoplastic with matched metal molds under extreme heat and pressure. Complete drain assembly, twin drain waste coupling, recessed divider wall between tubs and floor or wall mounting hardware. Shall meet ANSI Specification Z 124-2011. Color: White.

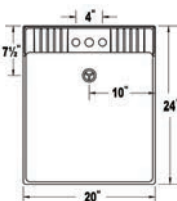
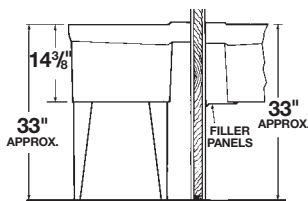

19F/W UTILATUB® LAUNDRY TUB

19F	Floor	24"	20"
19W	Wall	24"	20"
18-Gallon Capacity			



UTILATOP™ Top Cover Available (See page 25)

General: Furnish and install as shown on plans, UTILATUB® Laundry/Utility Tub Model: _____ (19F, 19W), as manufactured by E. L. Mustee & Sons, Inc. Tub shall be one-piece molded construction using structural thermoplastic with matched metal molds under extreme heat and pressure. Tub to include integrally molded drain assembly, stopper and floor or wall mounting hardware. Shall meet ANSI Specification Z 124-2011. Color: White.

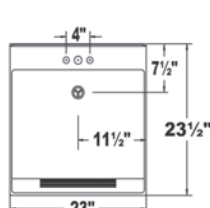
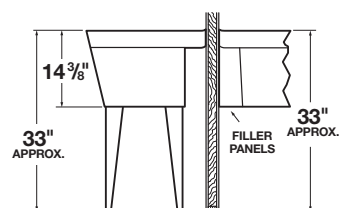

15F/W UTILATUB® LAUNDRY TUB

15F	Floor	23 "	23"
15W	Wall	23 "	23"
19-Gallon Capacity			



Built-in scrub board

General: Furnish and install as shown on plans, UTILATUB® Laundry/Utility Tub Model: _____ (15F, 15W), as manufactured by E. L. Mustee & Sons, Inc. Tub shall be one-piece molded construction using structural thermoplastic with matched metal molds under extreme heat and pressure. Tub to include built-in scrub board, integrally molded drain assembly, stopper and floor or wall mounting hardware. Shall meet ANSI Specification Z 124-2011. Color: White.

* Length (front to back);
Width (left to right).

Features (Continued)

- All Mustee laundry tubs accommodate 4" center set faucets. Model 15F/W, 18F/W, 27F/W and 26F/W can also accommodate 8" center set and single-lever faucets
- Sturdy, one-piece molded design
- Extra deep molded tubs minimize overflow risk
- Leakproof, integrally molded-in drain or drain assembly with stopper



Sturdy, steel legs



Ample shelf



Molded drain

Code Accepted

UTILATUB® and UTILATWIN® Laundry/Utility Tubs meet or exceed performance requirements as listed:

- International Association of Plumbing and Mechanical Officials (IAPMO®) 
- Warnock Hersey® (Canada) Listed – CSA test standards: Laundry Tray – #B45.0 and #B45.5, Drain – #B125 
- American National Standards Institute (ANSI) – Specification Z 124-2011 

UTILATOP™

Laundry Tub Cover

Unique Top Cover Creates Counter Space!



19.204A

Unique UTILATOP™ Laundry Tub Cover creates additional counter space. Supports up to 40 lbs. White, stain resistant finish. Fits UTILATUB® Models 19F, 19W, 18F and 18W.

Specifications

Premier DURASTONE® Laundry Tubs

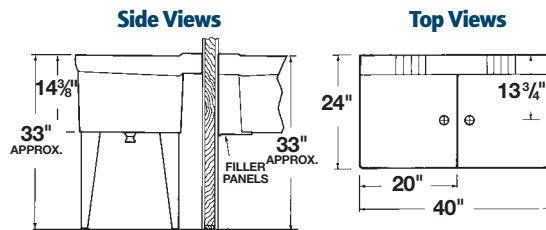

Model	Mount	Length*	Width*
26F/W UTILATWIN® LAUNDRY TUB			
26F	Floor	24"	40"
26W	Wall	24"	40"
38-Gallon Capacity			



General: Furnish and install as shown on plans, UTILATWIN® Laundry/Utility Tub Model: _____ (26F, 26W), as manufactured by E. L. Mustee & Sons, Inc. Unit shall be one-piece molded construction using natural crushed stone with polyester resin, complete drain assembly, twin drain waste coupling, recessed divider wall between tubs and floor or wall mounting hardware. Shall meet ANSI Specification Z 124-2011. Color: White with marbled finish.

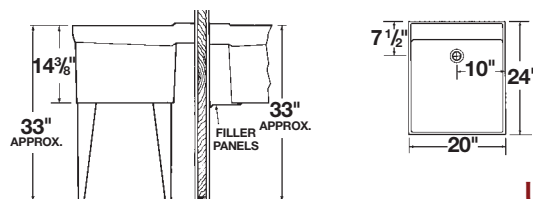

Model	Mount	Length*	Width*
18F/W UTILATUB® LAUNDRY TUB			
18F	Floor	24"	20"
18W	Wall	24"	20"
18-Gallon Capacity			



UTILATOP™ Top Cover Available (See page 25)

General: Furnish and install as shown on plans, UTILATUB® Laundry/Utility Tub Model: _____ (18F, 18W), as manufactured by E. L. Mustee & Sons, Inc. Tub shall be one-piece molded construction using natural crushed stone with polyester resin. Tub to include integrally molded drain assembly, stopper and floor or wall mounting hardware. Shall meet ANSI Specification Z 124-2011. Color: White with marbled finish.

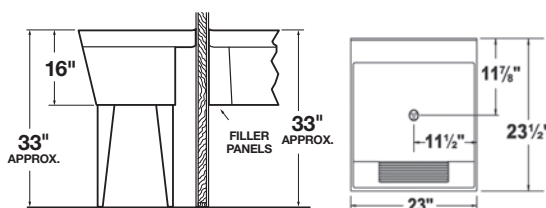

Model	Mount	Length*	Width*
17F/W UTILATUB® LAUNDRY TUB			
17F	Floor	23 1/2"	23"
17W	Wall	23 1/2"	23"
19-Gallon Capacity			

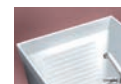

Built-in scrub board

General: Furnish and install as shown on plans, UTILATUB® Laundry/Utility Tub Model: _____ (17F, 17W), as manufactured by E. L. Mustee & Sons, Inc. Tub shall be one-piece molded construction using natural crushed stone with polyester resin. Tub to include built-in scrub board, integrally molded drain assembly, stopper and floor or wall mounting hardware. Shall meet ANSI Specification Z 124-2011. Color: White with marbled finish.

* Length (front to back);
Width (left to right).

28F BigTub UTILATUB® UTILITY TUB



Specifications

Side Views

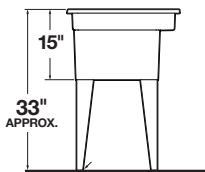

Top Views

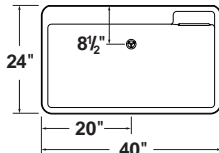

Great For Washing Really
BIG
THINGS!



If you need a BIG...really BIG space to wash your St. Bernard, clean off BBQ grates, or ice down a whole bunch of your favorite beverages...then you need the 28F BIGTUB™ UTILATUB® multi-purpose utility tub from the industry leader...E.L. Mustee & Sons, Inc.

Truly "King-sized," the 28F is one HUGE 40" wide, single bowl tub that's a great addition to any Man Cave, utility/laundry room, craft area and more.

The 28F BIGTUB™ UTILATUB® multi-purpose Utility tub...it's more than big enough to handle whatever big task or chore you have in mind!

Features

- One-piece molded tub of impact-resistant polypropylene
- Heavy gauge steel legs, with adjustable levelers
- Large, self-draining back shelf directs water run-off into the tub
- Accommodates single-lever or dual-handle faucet with 4" or 8" center
- Mold and mildew-resistant components
- Easy to assemble and install
- Color-fast, stain-resistant white finish
- Drain stopper

Model	Mount	Outside HxWxD	Inside HxWxD
-------	-------	---------------	--------------

28F UTILATUB®	Floor	34" x 40" x 24"	12 1/2" x 36 1/2" x 17 1/2"
---------------	-------	-----------------	-----------------------------

36-Gallon Capacity



General: Furnish and install as shown on plans, BIGTUB™ UTILATUB® Utility Tub Model _____ (28F) as manufactured by E.L. Mustee & Sons, Inc. Tub shall be one-piece molded polypropylene with matched metal molds. 28CF Combo kit to include: Swivel faucet with 24" long pull-out spout and lever handles; 1 1/2" P-trap with 12" tailpiece; and two flexible, 20" long braided supply lines. 28F to include steel legs with adjustable levelers; a 1 1/2" Molded-in drain and Drain stopper. 36-Gallon capacity. Shall meet ANSI Specification Z 124-2011 Color: White. Weight: 23 lbs.

21F LilTub UTILATUB® UTILITY TUB – Extra Narrow – Just 18" Wide – Fits Where Other Tubs Can't



Specifications

Side Views

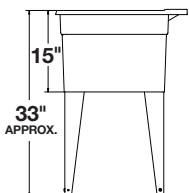

Top Views

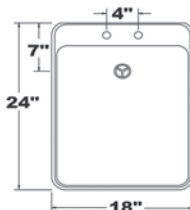

The 21F Lil' TUB brings all the best in Mustee's full size Laundry/Utility Tub features and benefits to an extra-narrow tub that fits in virtually any laundry space. "Preferred by the Pros" for decades, Mustee UTILATUB Laundry/Utility tubs are the quality standard in features, performance and value.

Features

- One piece molded construction
- 15-Gallon capacity, extra deep 13" tub with smooth surface
- Leakproof, integrally molded-in drain with stopper
- Connects to standard 1 1/2" P-Trap
- Accommodates single lever or dual-handle faucet with 4" or 8" center
- Includes finished steel legs with adjustable levelers
- Mold and mildew-resistant components
- Easy to assemble and install
- Color-fast white finish



Make your Chihuahua feel like a big dog!



Model	Mount	Width*	Length*
-------	-------	--------	---------

21F UTILATUB®	Floor	18"	23 1/2"
---------------	-------	-----	---------

15-Gallon Capacity

General: Furnish and install as shown on plans, UTILATUB® Laundry/Utility Tub Model 21 as manufactured by E. L. Mustee & Sons, Inc. Model 21 shall be one-piece molded Co-PolyPure™ tub complete with drain and floor hardware. Color: White with satin finish.

CO-POLYPURE™ LAUNDRY TUBS

Specifications

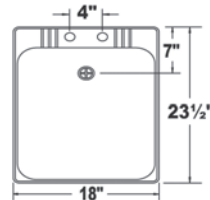
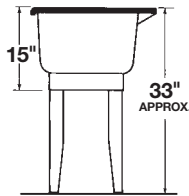
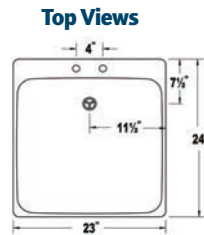
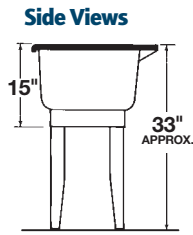

Model	Mount	Width*	Length*
14 UTILATUB®			
14	Floor	23"	25"
20-Gallon Capacity			

General: Furnish and install as shown on plans, UTILATUB® Laundry/Utility Tub Model 14 as manufactured by E. L. Mustee & Sons, Inc. Model 14 shall be one-piece molded Co-PolyPure™ tub complete with drain and floor hardware. Color: White with satin finish.

12 UTILATUB®			
12	Floor	18"	23½"
14-Gallon Capacity			

General: Furnish and install as shown on plans, UTILATUB® Laundry/Utility Tub Model 12 as manufactured by E. L. Mustee & Sons, Inc. Model 12 shall be one-piece molded Co-PolyPure™ tub complete with drain and floor hardware. Color: White with satin finish.

CABINET LAUNDRY TUB



91 and 94 DURATUB® – Cabinet Laundry Tub

If you're looking to reduce the visual clutter in your laundry or utility room, then Mustee's unique DURATUB® cabinet laundry tub will definitely meet your needs. This laundry tub in an attractive cabinet will create additional storage and counter space.

Features

- Narrow 19¼" width
- Large concealed shelf for storage
- Steel cabinet with enamel finish
- Extra deep, 19 gallon tub
- Top cover creates additional counter space
- Integral mounted drain for standard 1½" P-Trap
- Leg levelers and stopper
- Available in white, almond or biscuit

Specifications

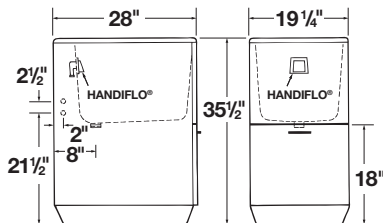

Model	Color
91	White
94	White

Top Cover	Color
92.200	White

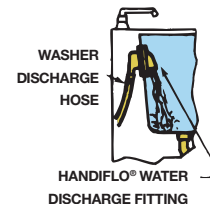

Model 94 includes HANDIFLO® Discharge System to conceal water discharge hose from washing machine.

General: Furnish and install as shown on plans, a DURATUB® Laundry Cabinet Model: _____, as manufactured by E. L. Mustee & Sons, Inc. Model 91 – 28" length, 19¼" width, 35½" height with electro-galvanized steel cabinet with baked-on enamel finish, molded top rim and top cover, molded-in drain. Color: White. Model 94 – same features as Model 91, plus HANDIFLO® water discharge fitting. Color: White.

Accessories

19.204A UTILATOP™ – Laundry Tub Top Cover

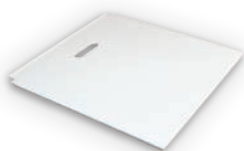

Conceals tub interior and provides additional counter space. Heavy-duty, molded UTILATOP™ fits Mustee's 19F (floor), 19W (wall), 18F (floor) and 18W (wall) UTILATUB® Laundry Tubs. White, colorfast surface is easy to clean.

93.600 – Laundry Tub Faucet



Chrome-finish, 4" center set, 6" swing spout with aerator and hose-end.



20.600 – Faucet Block



Deluxe molded faucet block mounts to laundry tub when using a clamp-on faucet with overhead water supply.

UTILATUB® & UTILATWIN® COMBO LAUNDRY TUBS

One convenient box...everything you need to install a Mustee laundry tub

Kit Includes:

Single or double laundry tub with self-leveling legs



1 1/2" P-Trap with 12" tailpiece



4" Center set chrome faucet with 6" swing spout and aerator



Two flexible, braided 20" supply lines and Teflon® tape



Drain stopper

Specifications



Side Views

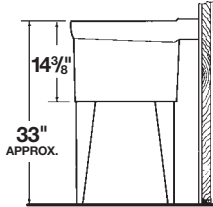

Top Views

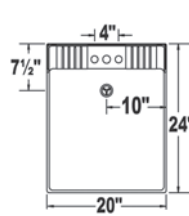

Model Style Width (A) Length (B) Drain (C)

19CFT UTILATUB® COMBO WITH TOP COVER

19CFT Single 20" 24" 10"
18-Gallon Capacity



Includes Top Cover 19.204A (See page 23)

General: Furnish and install as shown on plans, UTILATUB® Laundry/Utility Tub Model 19CF as manufactured by E.L. Mustee & Sons, Inc. Model 19C shall be one piece molded construction using structural thermoplastic with matched metal molds under extreme heat and pressure. Tub to include integrally molded drain assembly, stopper, floor hardware, faucet, supply lines, P-Trap, top cover and Teflon® tape. Shall meet ANSI Specification Z 124-2011 Color: White.

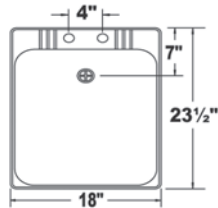
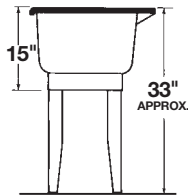

12C UTILATUB® COMBO

12C Single 18" 23 1/2" 9"
18-Gallon Capacity



General: Furnish and install as shown on plans, UTILATUB® Laundry/Utility Tub Model 12C as manufactured by E.L. Mustee & Sons, Inc. Model 12C—shall be one-piece molded Co-PolyPure™ tub, complete with drain, faucet, supply lines, P-Trap, Teflon® tape. Color: White with satin finish.

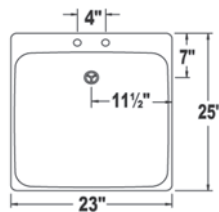
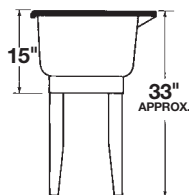

14CP UTILATUB® COMBO

14CP Single 23" 25" 11 1/2"
20-Gallon Capacity



General: Furnish and install as shown on plans, UTILATUB® Laundry/Utility Tub Model 14CP as manufactured by E.L. Mustee & Sons, Inc. Model 14CP—shall be one-piece molded Co-PolyPure™ tub, complete with drain, faucet, supply lines, P-Trap, Teflon® tape. Color: White with satin finish.

One box...everything you need to install. What could be more convenient?

Purchase one of Mustee's popular UTILATUB® or UTILATWIN® Combo Kit Laundry/Utility tubs, and you'll enjoy the convenience of having everything you need to install in one box...just add tools! You'll also benefit from the added value that Mustee's innovative laundry tub features and time-tested quality delivers.

Preferred by the Pros... Mustee's UTILATUB® and UTILATWIN® Laundry/Utility Tubs have been the quality and performance standard for residential, commercial, institutional and industrial laundry & utility tub applications for decades.



Specifications

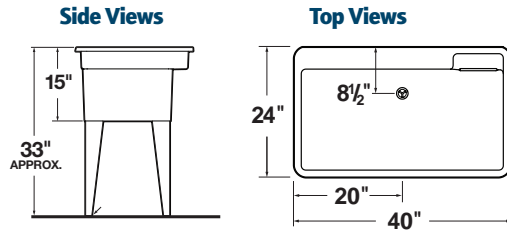

Model	Style	Width (A)	Length (B)	Drain (C)
-------	-------	-----------	------------	-----------

28CF BIGTUB™ UTILATUB® COMBO

28CF Single 40" 24" 8 1/2"

36-Gallon Capacity



General: Furnish and install as shown on plans, BIGTUB™ UTILATUB® Utility Tub Model ____ (28CF) as manufactured by E.L. Mustee & Sons, Inc. Tub shall be one-piece molded polypropylene with matched metal molds. 28CF Combo kit to include: Swivel faucet with 24" long pull-out spout and lever handles; 1 1/2" P-trap with 12" tailpiece; and two flexible, 20" long braided supply lines. 28CF to include steel legs with adjustable levelers; a 1 1/2" Molded-in drain and Drain stopper. 36-Gallon capacity. Shall meet ANSI Specification Z 124-2011 Color: White. Weight: 23 lbs.

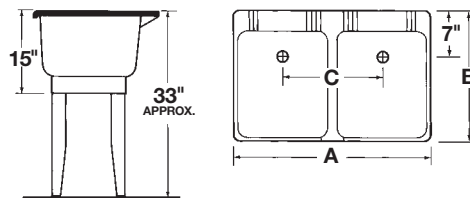

22C UTILATWIN® COMBO

22C Double 36" 23 1/2" 18"

31-Gallon Capacity



General: Furnish and install as shown on plans, UTILATWIN® Laundry/Utility Tub Model 22C, as manufactured by E. L. Mustee & Sons, Inc. Model 22C consists of molded Co-PolyPure™ dual tub, joined by molded bracket, complete with twin drain, faucet, supply lines, P-Trap, Teflon® tape and floor hardware. Color: White with satin finish.

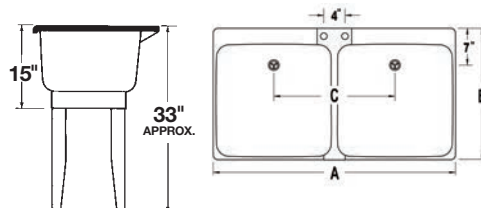

24C UTILATWIN® COMBO

24C Double 46" 25" 23"

41-Gallon Capacity



General: Furnish and install as shown on plans, UTILATWIN® Laundry/Utility Tub Model 24C, as manufactured by E. L. Mustee & Sons, Inc. Model 24C consists of molded Co-PolyPure™ dual tub, joined by molded bracket, complete with twin drain, faucet, supply lines, P-Trap, Teflon® tape and floor hardware. Color: White with satin finish.

* W=Width (left to right) L=Length (front to back)

99, 98 & 96 DURAPAN® WASHER AND WATER HEATER PANS

– Protects your belongings from water damage due to an overflowing clothes washer or hot water heater.

99 and 98 Fiberglass DURAPAN™



Model 99—center drain for installation directly over 2" ABS, PVC (Sch. 40) or iron drain pipe.
Model 98—furnished outlet fitting may be installed on bottom or any side for connection to 1" PVC drain pipe.

99 & 98 Features

- Removable aluminum front to simplify washer placement
- Reinforced design provides strength
- Securable to the floor to prevent movement
- Mold and mildew-resistant, easy to clean

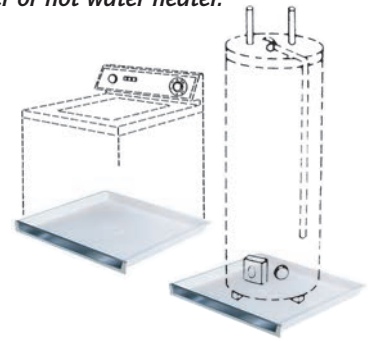

Specifications

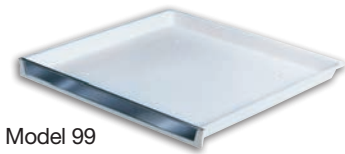

Model 99

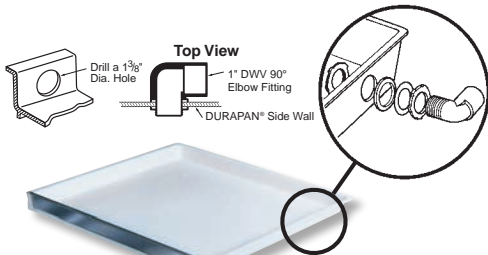
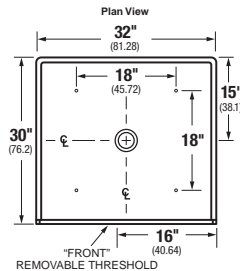

Model 98

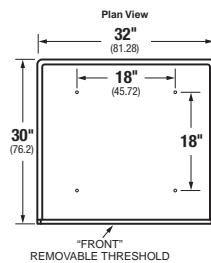

Model	Drain	Overall LxWxH*	Inside LxWxH*
-------	-------	----------------	---------------

99	Centered	30" x 32" x 2 1/2"	28" x 29" x 2" 
----	----------	--------------------	--

Sectional View

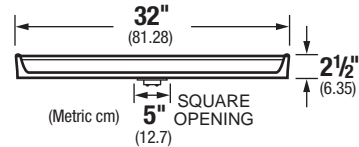

98	Side	30" x 32" x 2 1/2"	28" x 29" x 2" 
----	------	--------------------	--

Sectional View

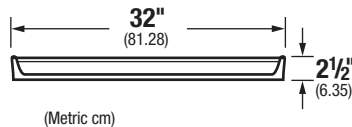

96 Co-PolyPure™ DURAPAN™



Model 96—furnished outlet fitting may be installed on bottom or any side for connection to 1" PVC drain pipe leading to drain.

Features

- Extra large for larger washing machines
- Mold and mildew-resistant
- Easy to clean
- Co-PolyPure™ thermoplastic

Model	Drain	Overall LxWxH*	Inside LxWxH*
-------	-------	----------------	---------------

96	Side or Bottom	31" x 33 1/2" x 2 1/8"	29" x 31 1/2" x 2"
----	----------------	------------------------	--------------------

Specifications

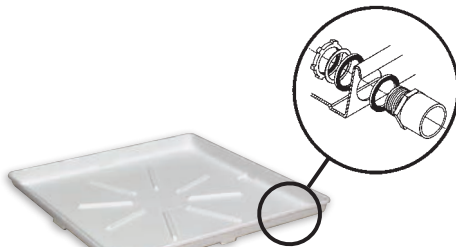

Model 96

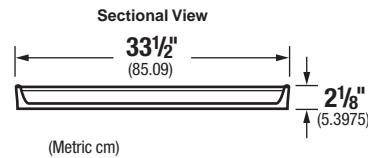
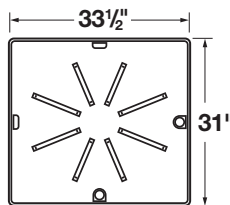

General: Furnish and install as shown on plans, DURAPAN™ Model: _____, as manufactured by E. L. Mustee & Sons, Inc. Models 99 and 98—one-piece compression molded fiberglass, using matched metal molds under extreme heat and pressure. Size: 30" x 32". Shoulder will be no less than 2 1/2" high. Removable aluminum threshold with water tight seal secured by stainless steel screws into threaded brass inserts. Mounting screws and anchors furnished to secure base to floor. Model 99 shall include IAPMO® Listed drain assembly for installation of 2" iron, PVC or ABS DWV (Schedule 40) sanitary waste pipe. Model 98 shall include 1" DWV 90° elbow fitting. Shall meet ASTM D 635, E-84 and E-162. Color: White.

Model 96—one-piece molded Co-PolyPure™, using matched metal molds. Shall include one 1" PVC fitting. Color: White. Install in compliance with local codes.

* L=Length (left to right); W=Width (front to back); H=Height (from floor surface)



DURASTALL® FREE-STANDING SHOWER STALL

Few could argue about the benefits of having an extra shower at home, in a cabin, pool side, etc. ...but, only Mustee free-standing shower stall delivers the best in features, benefits, durability and quality!

So wherever you need to add the convenience of an extra shower, make the smart money buy and specify a high quality Mustee shower stall. Available in 30" x 30", 32" x 32" and 36" x 36" sizes.



Features

- Standard components include...
 - Slip-resistant floor with drain
 - Shower valve
 - Curtain
 - Safety railing with molded in soap dish and shampoo holder
- Bases include a PVC drain for connection to a 2" (Sch. 40) ABS, PVC or iron DWV pipe
- Knock-down construction makes portability extremely easy
- Shower stall materials are mold and mildew-resistant

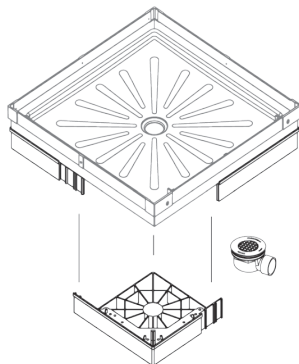
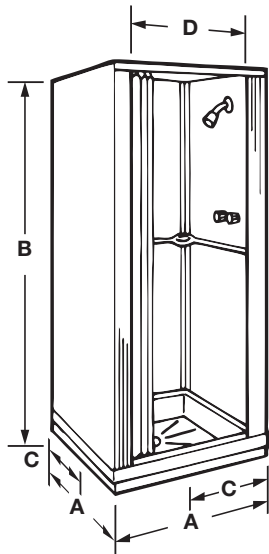

Specifications

80, 140 DURASTALL®

Model	Nom. Size	Type Base	A	B	C	D
80	32" x 32"	Standard	32 ⁵ / ₈ "	75 ³ / ₈ "	16 ⁵ / ₁₆ "	24"
140	36" x 36"	Standard	36 ⁵ / ₈ "	75 ³ / ₈ "	18 ⁵ / ₁₆ "	28"

General: Furnish and install as shown on plans, a free-standing DURASTALL® Shower Stall Model: _____, as manufactured by E. L. Mustee & Sons, Inc. Consist of three, white high-gloss thermoplastic walls, molded top frame, rigid aluminum front supports, one-piece wrap-around railing with built-in soap dish and container. Skid-resistant floor with drain assembly, shower head and valve, shower curtain and rod, plus assembly hardware.

30, 68 DURASTALL®

30	30" x 30"	Standard	30"	73"	15"	24"
68	32" x 32"	Standard	32 ⁵ / ₈ "	74 ³ / ₄ "	16 ⁵ / ₁₆ "	24"

General: Furnish and install as shown on plans, a free-standing DURASTALL® Shower Stall Model: _____, as manufactured by E. L. Mustee & Sons, Inc. Consist of three, white, high-gloss thermoplastic walls, molded top frame, rigid thermoplastic front supports, one-piece, wrap-around railing with built-in soap dish and container. Skid-resistant floor with drain assembly, shower head and valve, shower curtain and rod, plus assembly hardware.

Accessories

Shower Doors – Install to Open from Either Side

Shower doors are available, featuring aluminum frames with magnetic latch mount to open left or right.

Model	Opening	Height	Fits DURASTALL® Models
GLASS DOOR – obscure, tempered safety glass panel with aluminum frame			
88.700	24"	64"	80
48.700	28"	64"	140

Extended Base Kit – Extension raises the base up 2 ³/₄"

Add this kit to the bottom of the standard base included in the Mustee Model 80 or 140 DURASTALL® Shower Stall (bought after 6-01-16) to raise the base up by 2 ³/₄". This will allow you to run a 1 ¹/₂" PVC pipe (not included) from under the shower floor, on top of the sub-floor to an existing drain. The drain can be positioned so the pipe can come out from under the shower floor in one of four directions.

Model	Max. Size	Fits DURASTALL® Models
86.500	36" x 36" x 2 ³ / ₄ "	80, 140

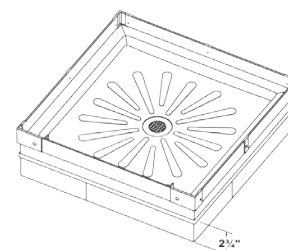

Kit includes:
4 Extension Blocks
1 82.400A Drain Kit



TOPAZ™, VARISTONE™, DURAWALL®, BATHTUB WALLS & DURATRIM™ WINDOW KITS

Exceptional bathtub walls from E. L. Mustee & Sons, Inc. are designed with durability and style.

Premium materials paired with a multitude of configurations and sizes, Mustee bathtub wall selections give you abundant options to construct the bathroom you desire.

All bathtub walls systems will fit any standard 30" x 60" bathtub. Select Mustee bathtub wall systems are also available for other bathtub sizes.





Features

- Adhesive mount and direct-to-stud mount styles available
- Spacious molded-in shelves
- Seamless corner panels with overlapping edges on adhesive mount
- Trimmable DURAWALL® panels simplify installation for out-of-plumb alcoves
- All models available in color-fast white with additional color options
- Semi-gloss finish, mold and mildew-resistant surface

Code Accepted

TOPAZ™, VARISTONE™ and DURAWALL® fiberglass bathtub walls meet or exceed performance requirements as indicated:

- American Society of Testing and Materials (ASTM) – D 635, E-84 and E-162 
- American National Standards Institute (ANSI) – Specification Z 124-2011 
- Inhalation Toxicity Test – to evaluate inhalation health hazards with combustible products
- CAN/ULC S102-07 Burn and Smoke Test

572T VARISTONE™ Tall Premium Fiberglass Bathtub Walls – Adhesive Mount, Code Accepted



572T VARISTONE™ bathtub walls shown with optional bathtub, shower head and valve.

Mustee's VARISTONE™ premium fiberglass, Model 572T bathtub wall surround brings together a classic design, high quality finish and upscale embossed tile pattern across its expansive 72" tall walls.

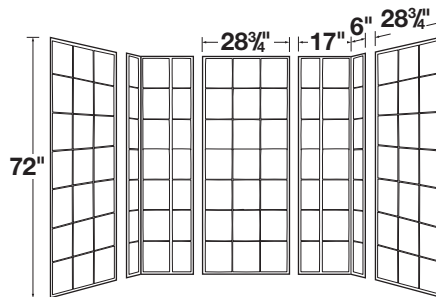

Model Color

572TWHT White

572TBN Bone

Fits Up to 60" Wide by 34" Deep

General: Furnish and install as shown on plans, fiberglass VARISTONE™ Bathtub Walls Model 572T as manufactured by E.L. Mustee & Sons, inc. Shall be semi-gloss, 5-piece wall system. Panels are molded using matched metal molds under extreme heat and pressure with a minimum thickness of 125 mils. Shall meet ANSI Specifications Z 124-2011 Colors: _____ (White, Bone)

670 TOPAZ™ Premium Fiberglass Bathtub Walls – Direct-To-Stud Mounted, Code Accepted



Features

- Embossed 7" x 7" tile pattern.
- Produced from high-grade, reinforced, molded fiberglass for optimum strength and impact resistance
- Fits Topaz™ Bathtubs, as well as standard 30" x 60" bathtubs of others
- Includes two molded-in self-draining shelves
- Three panel wall system with tongue-and-groove seams to create a watertight wall surround
- Mounts direct-to-stud with mounting flanges hidden behind drywall
- Smooth, colorfast semi-gloss finish, resists scuffs
- Mold and mildew-resistant...easy to clean

Model	Color
670WHT	White

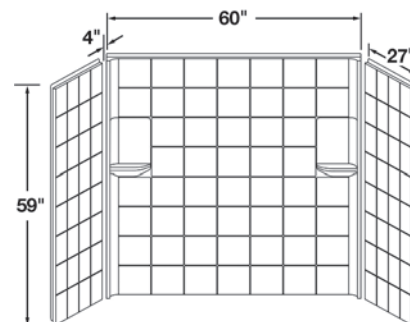

General: Furnish and install as shown on plans, 670 TOPAZ™ bathtub walls as manufactured by E.L. Mustee & Sons, Inc. Shall be semi-gloss, three-piece wall. Panels are molded fiberglass using matched metal molds under extreme heat and pressures with a uniform thickness of 125 mils and mounts direct-to-studwalls. Includes center panel with two molded-in shelves and two side panels. Self-aligning panels use a tongue-and-groove connection. Shall meet ANSI Specification Z 124-2011. Color: White. Install in compliance with local codes.

660 TOPAZ™ Premium Fiberglass Bathtub Walls – Direct-To-Stud Mounted, Code Accepted



Features

- Produced from high-grade, reinforced, molded fiberglass for optimum strength and impact resistance
- Fits Topaz™ Bathtubs, as well as standard 30" x 60" bathtubs of others
- Includes a large, molded-in, self-draining shelf
- Three panel wall system with tongue-and-groove seams to create a watertight wall surround
- Mounts direct-to-stud with mounting flanges hidden behind drywall
- Smooth, colorfast semi-gloss finish, resists scuffs
- Mold and mildew-resistant...easy to clean

Model	Color
660WHT	White
660BN	Bone
660BT	Biscuit

Fits 30" x 60" TOPAZ™ Bathtub

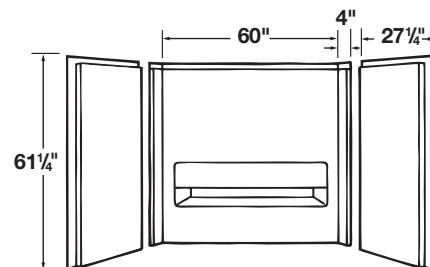

General: Furnish and install as shown on plans, 660 TOPAZ™ bathtub walls as manufactured by E.L. Mustee & Sons, Inc. Shall be semi-gloss, three-piece wall. Panels are molded fiberglass using matched metal molds under extreme heat and pressure with a uniform thickness of 125 mils and mount direct-to-studwalls. Includes center panel with molded-in shelf and two side panels. Self-aligning panels use a tongue-and-groove connection. Shall meet ANSI Specification Z 124 2011. Color: _____ (White, Bone, Biscuit). Install in compliance with local codes.

Common Features of the 670 and 660 TOPAZ™ Bathtub Walls



- Panels with tongue-and-groove seams.



- Reverse side of center panel has clips for securing to bathtub.



- 1 1/4" flanges fasten direct-to-studwalls with screws, drywall conceals flanges.

Specifications

Premium Fiberglass Bathtub Walls – Adhesive Mount, Code Accepted (See page 30)



350 DURAWALL®

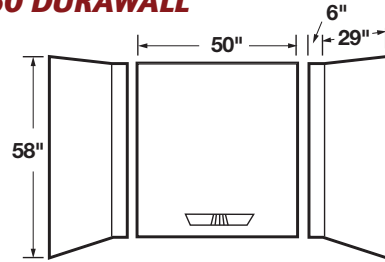

Model	Color
-------	-------

350WHT	White
350BN	Bone
350BT	Biscuit

Fits 30" x 60" Bathtub
Caulking and adhesive provided

General: Furnish and install as shown on plans, DURAWALL® Bathtub Walls Model 350, as manufactured by E. L. Mustee & Sons, Inc. The wall system shall be three-piece construction with molded-in shelf. Panels shall include 20% fiberglass reinforced composite material and be manufactured with matched metal molds under extreme heat and pressure with a uniform thickness of 85 mils. Shall be semi-gloss, scuff-resistant surface. Unit shall meet ANSI Specification Z 124-2011. Color: _____ (White, Bone, Biscuit).



500 DURAWALL®

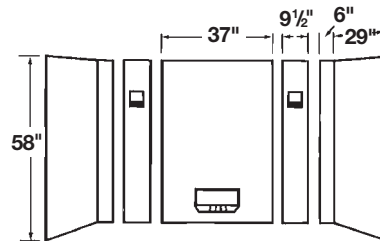

500WHT	White
500BN	Bone

Fits 30" x 60" Bathtub

General: Furnish and install as shown on plans, DURAWALL® Bathtub Walls Model 500, as manufactured by E. L. Mustee & Sons, Inc. The wall system shall be five-piece construction with three molded-in shelves. Panels shall include 20% fiberglass reinforced composite material and be manufactured with matched metal molds under extreme heat and pressure with a uniform thickness of 85 mils. Shall be semi-gloss, scuff-resistant surface. Unit shall meet ANSI Specification Z 124-2011. Color: _____ (White, Bone).



557 DURAWALL®

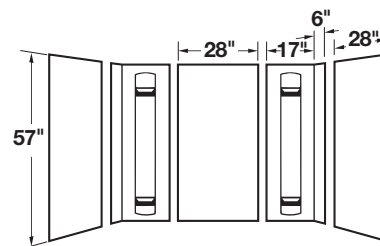

557WHT	White
--------	-------

Fits 30" x 60" and 32" x 60" Bathtubs

General: Furnish and install as shown on plans, DURAWALL® Bathtub Walls Model 557, as manufactured by E. L. Mustee & Sons, Inc. The wall system shall be five-piece construction with four molded-in shelves. Panels shall include 20% fiberglass reinforced composite material and be manufactured with matched metal molds under extreme heat and pressure with a uniform thickness of 75 mils. Shall be matte finish, scuff-resistant surface. Unit shall meet ANSI Specification Z 124-2011. Color: _____ (White).

Specifications

300.600 DURATRIM™ Fiberglass Window Kit – Code Accepted



Protect window above bathtub. Adhesive-mounted 5-piece fiberglass panels fit windows up to 36" wide with 8" sill depth. May be cut to fit sill and side moldings, easy to install.

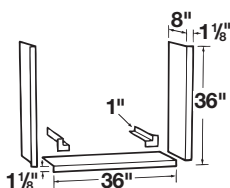

300.600W	White
300.600BN	Bone

Adhesive provided.

General: Furnish and install as shown on plans, DURATRIM™ Window Trim Kit Model 300.600, as manufactured by E. L. Mustee & Sons, Inc. Made of fiberglass, consists of three 36" by 8" panels and two 8" by 1" corner molding pieces. Adhesive provided. Shall meet ANSI Specification Z 124-2011. Color: _____ (White, Bone).

Specifications

Deluxe Thermoplastic Bathtub Walls – Adhesive Mount



56 DURAWALL® Whirlpool Sized Up To 42" Deep By 72" Wide

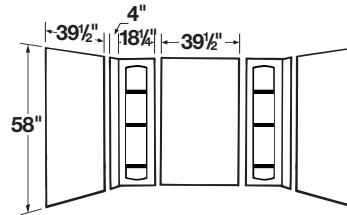

Model	Color
-------	-------

56WHT	White
-------	-------

56BN	Bone
------	------

Fit 42" x 72" Bathtub

General: Furnish and install as shown on plans, DURAWALL® Bathtub Wall Model 56, as manufactured by E. L. Mustee & Sons, Inc. The hi-impact thermoplastic wall system shall be 5-piece construction with six formed shelves. One-piece, seamless corner panels with overlapping edges. Uniform color throughout entire thickness of each panel. Color: _____ (White, Bone).



53 DURAWALL®

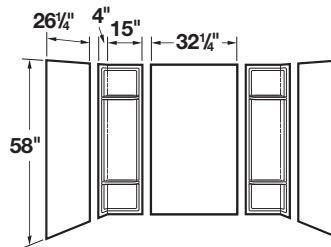

53WHT	White
-------	-------

53BN	Bone
------	------

Fit 30" x 60" Bathtub

General: Furnish and install as shown on plans, DURAWALL® Bathtub Wall Model 53, as manufactured by E. L. Mustee & Sons, Inc. The hi-impact thermoplastic wall system shall be 5-piece construction with four formed shelves. One-piece, seamless corner panels with overlapping edges. Uniform color throughout entire thickness of each panel. Color: _____ (White, Bone).



950 DURAWALL®

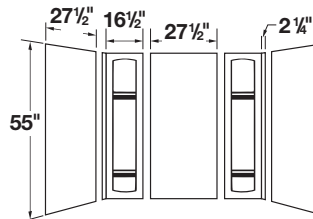

950WHT	White
--------	-------

Fit 30" x 60" Bathtub

General: Furnish and install as shown on plans, DURAWALL® Bathtub Wall Model 950, as manufactured by E. L. Mustee & Sons, Inc. The white thermoplastic wall system shall be 5-piece construction with four formed shelves. One-piece, seamless corner panels with overlapping edges. Uniform color throughout entire thickness of each panel. Color: White.

Specifications

52.600W DURATRIM™ Thermoplastic Window Trim Kit



Protect window above bathtub. Adhesive mounted, 3-piece thermoplastic panels fit windows up to 36" wide with 8" sill depth. May be cut to fit sill and side moldings, easy to install.

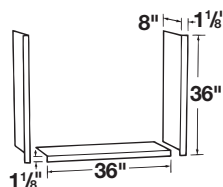

52.600W	White
---------	-------

Adhesive provided.

General: Furnish and install as shown on plans, DURATRIM™ Window Trim Kit Model 52.600W, as manufactured by E. L. Mustee & Sons, Inc. Made of white, high-impact thermoplastic, consists of three 36" by 8" panels. Color: White.

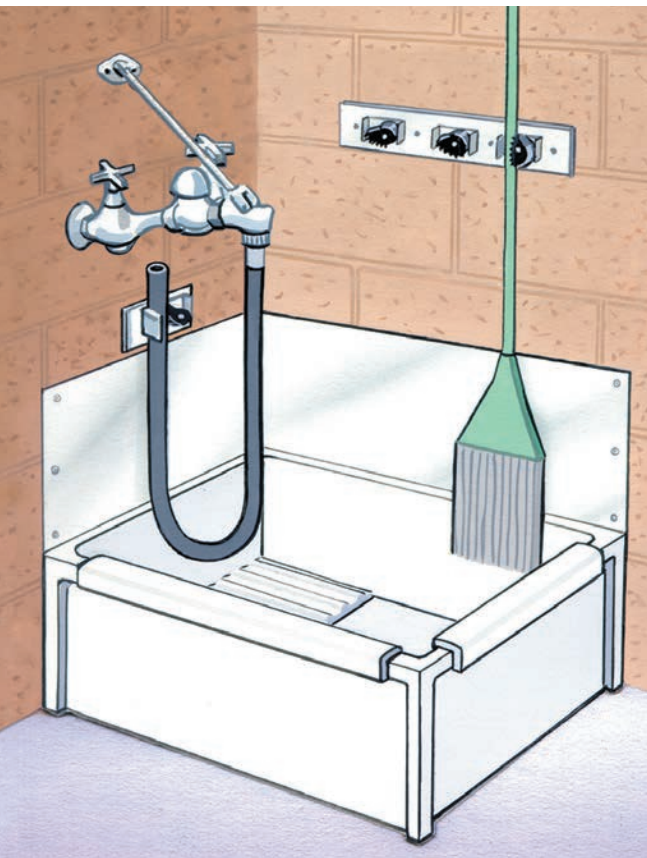

MOP SERVICE BASINS

Mustee's extra-tough mop service basins and companion products have long been the preferred choice of specifying architects and engineers.

Whether installed in a factory, hospital, school, office building or even in a garage, work room or basement, Mustee's line of Mop Service Basins include the features users appreciate most. The rugged, easy to install and perfectly functional...Mustee's line of Mop Service Basins will deliver years of service.



Features

- One-piece molded from high impact resistant DURASTONE® fiberglass
- Elevated, self-draining shelf (Model 65M) and removable strainer
- Integral molded-in drain with seal for 3" ABS, PVC (Sch. 80) or cast iron
- Available drain seals for connecting 2" pipe or 3" soil pipe
- Numerous mop basin accessories are also available

Code Accepted

Mustee's Mop Service Basins meet or exceed performance requirements:

- International Association of Plumbing and Mechanical Officials (IAPMO®) Listed
- Warnock Hersey® (Canada) Listed – CSA Test Standards: Mop Basins – #B45.0
- American National Standards Institute (ANSI) – Specification Z 124-2011
- American Society of Testing and Materials (ASTM) – D 635 E-84 and E-162
- CAN/ULC S102-07 Burn and Smoke Test



Specifications

63M Mop Basin – 24" x 24" x 10"



Sectional Views

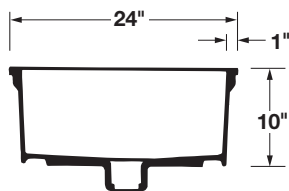

Top Views

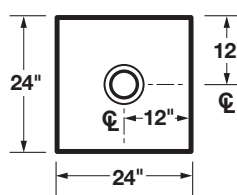

Model	Length*	Width*
63M	24"	24"

65M Mop Basin – Elevated Shelf, 24" x 36" x 10"

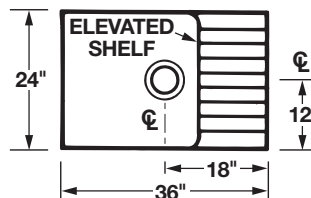
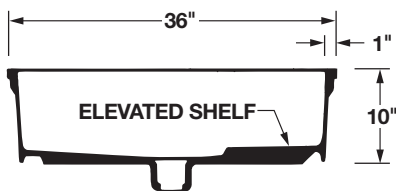

65M	24"	36"
-----	-----	-----

General: Furnish and install as shown on plans, Mop Service Basin Model: _____, as manufactured by E. L. Mustee & Sons, Inc. Unit to be one-piece molded construction by matched metal molds under extreme heat and pressure using fused natural crushed stone with polyester resin. Models shall have integrally molded drain assembly with drain seal and strainer for connection to 2" or 3" iron, ABS or PVC pipe.

Model 63M—10" high with 1" wide shoulder, drain accommodates 3" pipe.

Model 65M—10" high with 1" wide shoulder and integrally molded self-draining shelf, drain accommodates 3" pipe.

MOP SERVICE BASIN ACCESSORIES

To complete a commercial or residential mop service basin installation, specify and install Mustee's mop service faucet and companion products listed below.

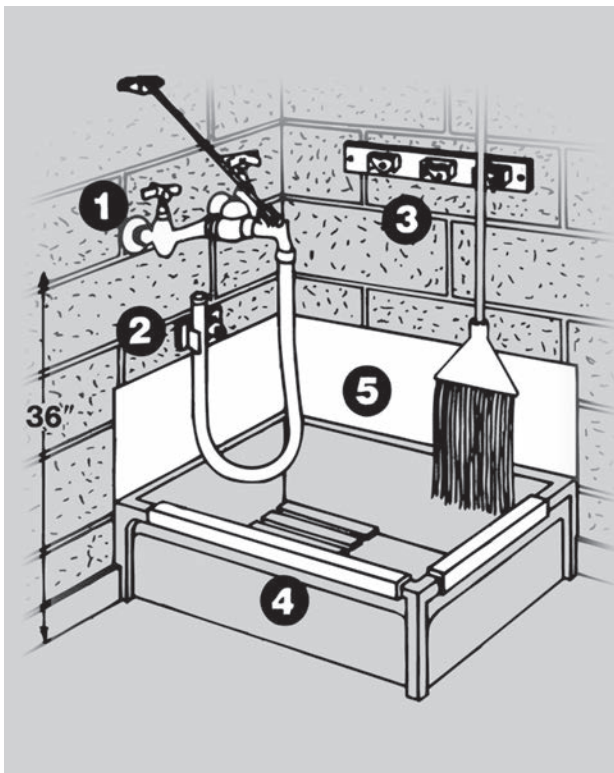

Specifications

- 1 63.600A SERVICE FAUCET** – Chrome plated brass service sink faucet, 1/2" pipe eccentric inlets on 8" centers. Vacuum breaker integral stops, chrome plated (H&C) handles, 3/4" hose end spout with pail hook, top reinforcing bar and mounting bracket. Shall meet ANSI Specifications A112.1.1, Section 2.9 and A112.18.1M, CSA Listed. **ANSI**

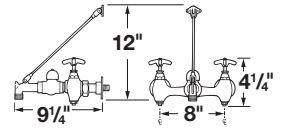

- 2 65.700 HOSE and HOSE HOLDER** – Heavy-duty 3/8" diameter, reinforced 31" rubber hose with brass couplings on one end. Spring loaded, molded rubber hose holder mounts on stainless steel wall plate.



- 3 65.600 MOP HANGER** – Three spring-loaded rubber holders mounted to 3" x 22" stainless steel wall plate. Wall anchors and mounting screws included.

- 4 BUMPER GUARDS** – Protect rims, snap-on

High impact resistant vinyl

- 63.401 – 20 3/4" long white, fits Models 63M and 65M
65.403 – 32 3/4" long white, fits Model 65M

Stainless steel

- 63.403 – 20 3/4" long, fits Models 63M and 65M
65.404 – 32 3/4" long, fits Model 65M

- 5 DURAGUARD™ WALL GUARDS** – Protect wall surfaces, 12" height, 20 gauge, #304 stainless steel.

- 67.2424 – two panels and bracket for 24" x 24" corner
67.2436 – two panels and bracket for 24" x 36" corner
67.24C – one 24" panel and corner bracket
67.36C – one 36" panel and corner bracket

- 6 OPTIONAL SEALS** – For installations with following pipe, order separately.

- 65.308 – for 2" PVC, ABS and iron
65.309 – for 3" PVC, ABS and iron, included with mop basin
65.311 – for 3" soil pipe (no hub)

16 SERVICE MOP SINK

Wall-mounted mop sink installs anywhere, including the utility room, basement, garage or outdoors. Ideal for cleaning large utensils. Molded-in drain assembly for standard 1 1/2" trap.

Specifications

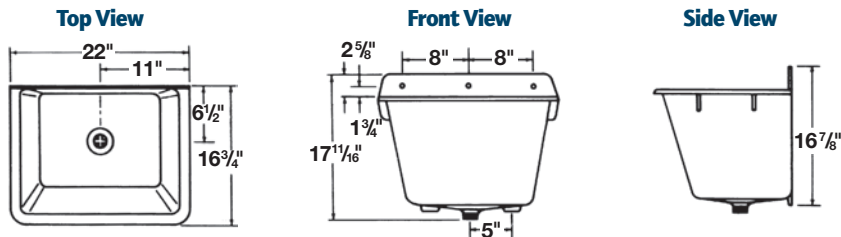

Model	Length*	Width*
16	16 3/4"	22"

12-Gallon Capacity

* Length (front to back); Width (left to right).



General: Furnish and install as shown on plans, UTILATUB® Mop Sink Model 16, as manufactured by E. L. Mustee & Sons, Inc. One-piece molded construction using structural Co-PolyPure™ thermoplastic, complete with molded-in drain assembly for 1 1/2" traps, wall mount.



Quality Products for Residential, Commercial, Healthcare & Institutional Applications

The E.L. Mustee & Sons, Inc. product line meets numerous applications within four broad markets...residential, commercial, healthcare and institutional. We invite you to review the complete line of Mustee products from bathtubs, shower walls and bases to laundry/utility tubs, safety grab bars, and mop service basins.



Residential – from new single-family and cluster homes to older homes and apartment bath renovations.



Healthcare – includes hospitals, health care facilities, adult communities, assisted living facilities, apartments and more.



Commercial – includes offices, industrial buildings, hotels and motels.



Institutional – includes schools, colleges, libraries, laboratories and more.

Use this QR code to access our website with your smart phone.



E. L. Mustee & Sons, Inc.



5431 West 164th St.
Brook Park, OH 44142
Phone: 216-267-3100
Fax: 216-267-9997
Email: info@mustee.com

Visit us on the web at: www.mustee.com

Code Compliance

Code Compliance as indicated, most Mustee products are listed by:

International Association of Plumbing and Mechanical Officials (IAPMO®) – United States 

Warnock Hersey® – Canada 
Intertek 

To reorder this catalog specify ADV-500

Notice: Our continuous commitment to product improvement may result in changes to product specifications without notice.
© 2017 E. L. Mustee & Sons, Inc. Patented and patents pending. ADI/03-17. Made and Printed in U.S.A. Printed on Recycled Paper 