

Rinnai®

I-SERIES PLUS™

Condensing Gas Boiler

Built for the PRO, by the PRO™

NEW

UP TO
96%
AFUE



IP150S Solo Model



IP199199C Combi Model



12 Years
on the Heat Exchanger
5 Years
on Parts
1 Year
on the Labor



RINNAI 
CENTRAL

Download our App for Quick
Easy access to Key Features

Featuring 5 **NEW** Combi Models, 2 **NEW** Solo Models and **SMART-CONNECT™** for simplified set-up.

I-SERIES PLUS™

Built for the PRO, by the PRO™

The **NEW I-SERIES Plus™** line of **Solo** and **Combi Condensing Gas Boilers** offers unmatched value and performance with an expanded product line up to 199k Btu. Now you can **Rely on Rinnai** for all your Residential Heating projects no matter the size or complexity.



iP150S Solo Model



IP199199C Combi Model



NEW

SMART SENSE™

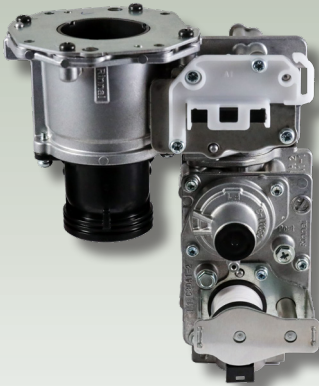

Rinnai's proprietary **Adaptive Gas Valve Technology** adjusts to either Natural Gas or Liquid Propane Gas for optimal combustion - **no conversion kit required.**

Smart Sense™ Adaptive Gas Valve technology is available on the following models: IP060160, IP090099C, IP090160C, IP090199C, IP120199C, IP150199C, IP060S, IP090S, IP120S, IP150S

NEW

SMART CONNECT™

Smart Connect™ for PROs

Allows you to connect your smart phone or tablet to the **I-SERIES Plus™** via Bluetooth® (no adapter required). Use the **Rinnai Central™** App for quick, simplified boiler set-up and registration, significantly reducing your install time.



SCAN ME



SCAN ME



RINNAI CENTRAL™

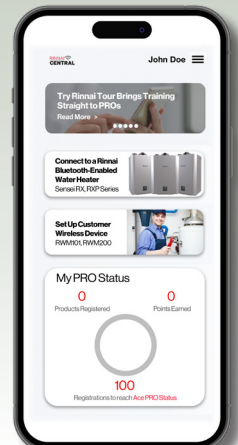



Comfort & Convenience

- **NEW** 4 Built-In Zones for better comfort levels
- **NEW Smart Sense™** Adaptive Gas Valve Technology (Up to 150k Btu models only)
- **NEW** 7 Heating Reset Curves (6 standard, 1 custom) for consistent temperatures
- **NEW** Advanced Controls with Intuitive Front Panel Display
- **NEW** Air Handler Connectivity
- **NEW** Smart-Circ™ learns hot water patterns and automatically schedules recirculation during regular demand periods
*Requires external recirculation pump**



Rinnai offers the most models with an industry-leading 96% AFUE*

*AHRI Directory of Certified Product Performance

Operational Performance

- Up to 96% AFUE for significant energy savings
- **NEW** Cascade up to 24 Combi boilers / 1 Combi boiler and up to 23 CX tankless units / up to 24 Solo boilers**
- **NEW** Common Venting up to 8 units***
- Low NOx Emissions (≤ 20 ppm) in Compliance with SCAQMD
- High Altitude Approved up to 10,100 feet

All Combi Models Deliver Simultaneous Domestic Hot Water and Space Heating

Flexible Installation

- **NEW** Use the **Rinnai Central™** App for quick parameter settings
- **NEW SmartConnect™** Bluetooth® from your Hand-Held Device
- **NEW** Quick Set-Up screen for speedy unit configuration
- Easy Hang Wall Bracket
- **NEW** Longer Venting Runs: 75 ft on 2" and 160 ft on 3" vent pipe



All **I-SERIES Plus™** models offer 4 zone capability, 2" venting up to 75 ft., and a proportional valve that allows **simultaneous delivery of domestic hot water and space heating on all Combi Models.**

* Combi Units only

** Rinnai can cascade Solo ≥ 175 k Btu up to 24 solo boilers

*** Rinnai can common vent Solo Boilers up to 8 units ≥ 120 k Btu

I-SERIES PLUS™

Condensing Gas Boiler

Look inside the I-SERIES Plus™

60-150k Btu Models

High-Efficiency Condensing Boiler

Re-designed to Perform and Impress

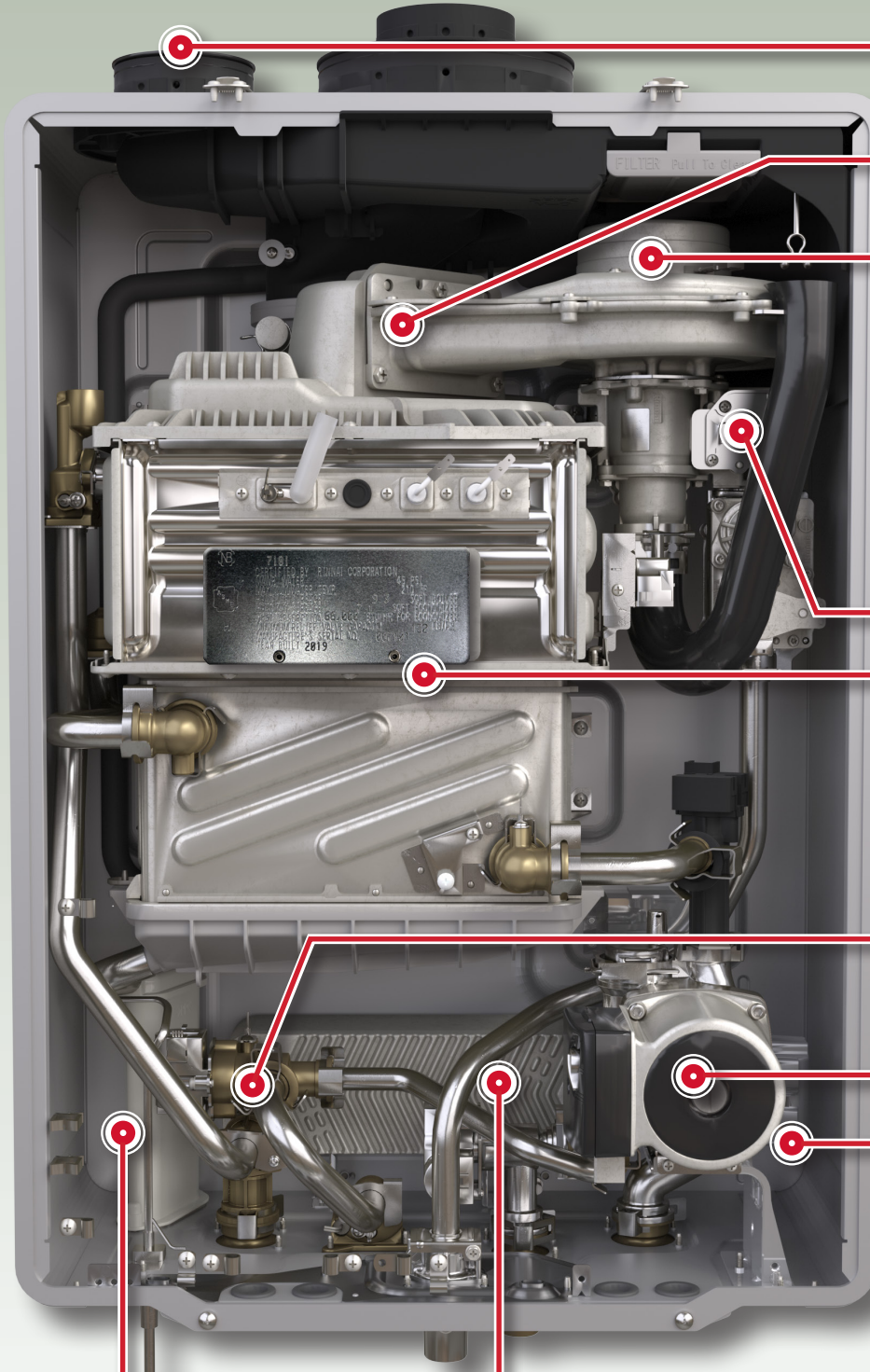

NEW 2-Inch longer Vent runs up to 75 ft and 3-inch vent runs up to 160 ft. All venting materials (PVC/CPVC/PP/SS) approved. This applies to both, air intake and exhaust.

Combustion Check Valve prevents cold air or flue gases from entering living space

Turbo Fan enables longer vent runs with more options, works with gas valve for optimal performance and efficiency

NEW SMARTSENSE Adaptive Gas Technology

Primary and Flat Plate Secondary Stainless Steel Heat Exchangers for additional efficiency improvements

Servo-Based Temperature Controller; Water Flow and Bypass Servo Valves for DHW work together to deliver precise DHW temperature control (no mixing valve required)

Integrated Pump (Combi Models only)

Simultaneous space heating (SH) and Domestic Hot Water (DHW) enabled by **Proportional Valve**

Integrated Condensate Trap to remove acidic condensate

Stainless Steel Flat Plate Domestic Hot Water Heat Exchanger (Combi Models Only)

PC Board and Controller with BLE capability and integrated Smart-Circ™ Logic

NEW Innovative Logic comes with built-in 4-zone capability with option of designating one zone for DHW recirc pump or indirect tank (for heat only models)

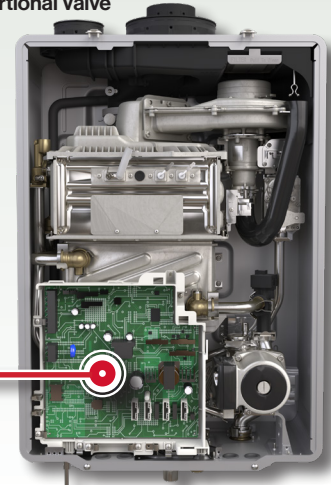

I-SERIES PLUS™

Condensing Gas Boiler
60-150k Btu Models

Solo Models

Pressure Drop and Water Flow

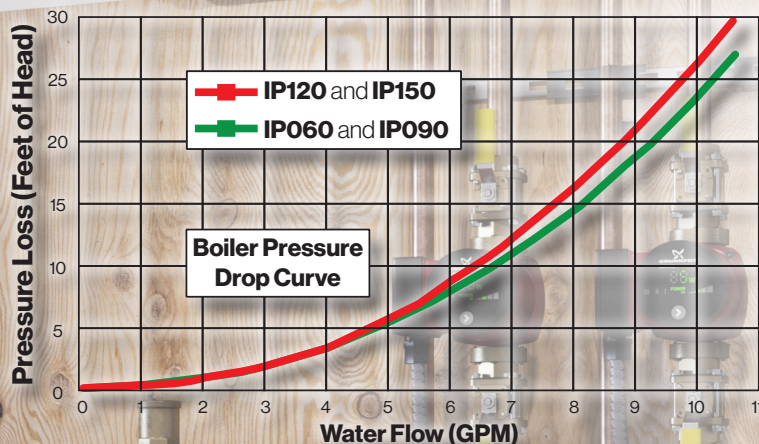

Note: External boiler pump required

Combi Models

Pressure Drop and Water Flow

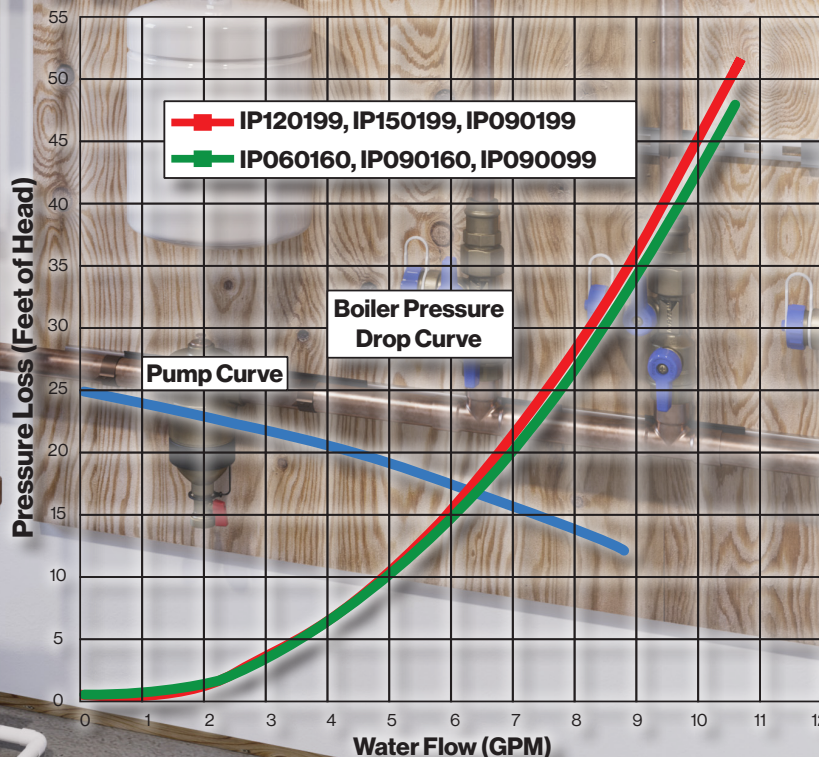

Look inside the **I-SERIES Plus™**
 175 and 199k Btu Models
High-Efficiency Condensing Boiler
 Higher Capacity for High Demand Applications

I-SERIES PLUS™
 Condensing Gas Boiler

NEW 2-Inch longer Vent runs up to 75 ft and 3-inch vent runs up to 160 ft. All venting materials (PVC/CPVC/PP/SS) approved. This applies to both, air intake and exhaust.

Concentric Vent or 2-Inch Exhaust 2 in. / 4 in. or 3 in. / 5 in. direct vent or exhaust in 2-pipe configurations

Air inlet filter

Combustion Analyzer Port

Burner Assembly

Stainless Steel Heat Exchanger

Turbo Fan enables longer vent runs with more options, works with gas valve for optimal performance and efficiency

Integrated Check Valve

Stainless Steel Flat Plate Domestic Hot Water Heat Exchanger

Servo-Based Temperature Controller delivers precise DHW temperature control (no mixing valve required)

Innovative Logic with 4-Zone Capability

PC Board and Controller with BLE capability and integrated Smart-Circ™ Logic

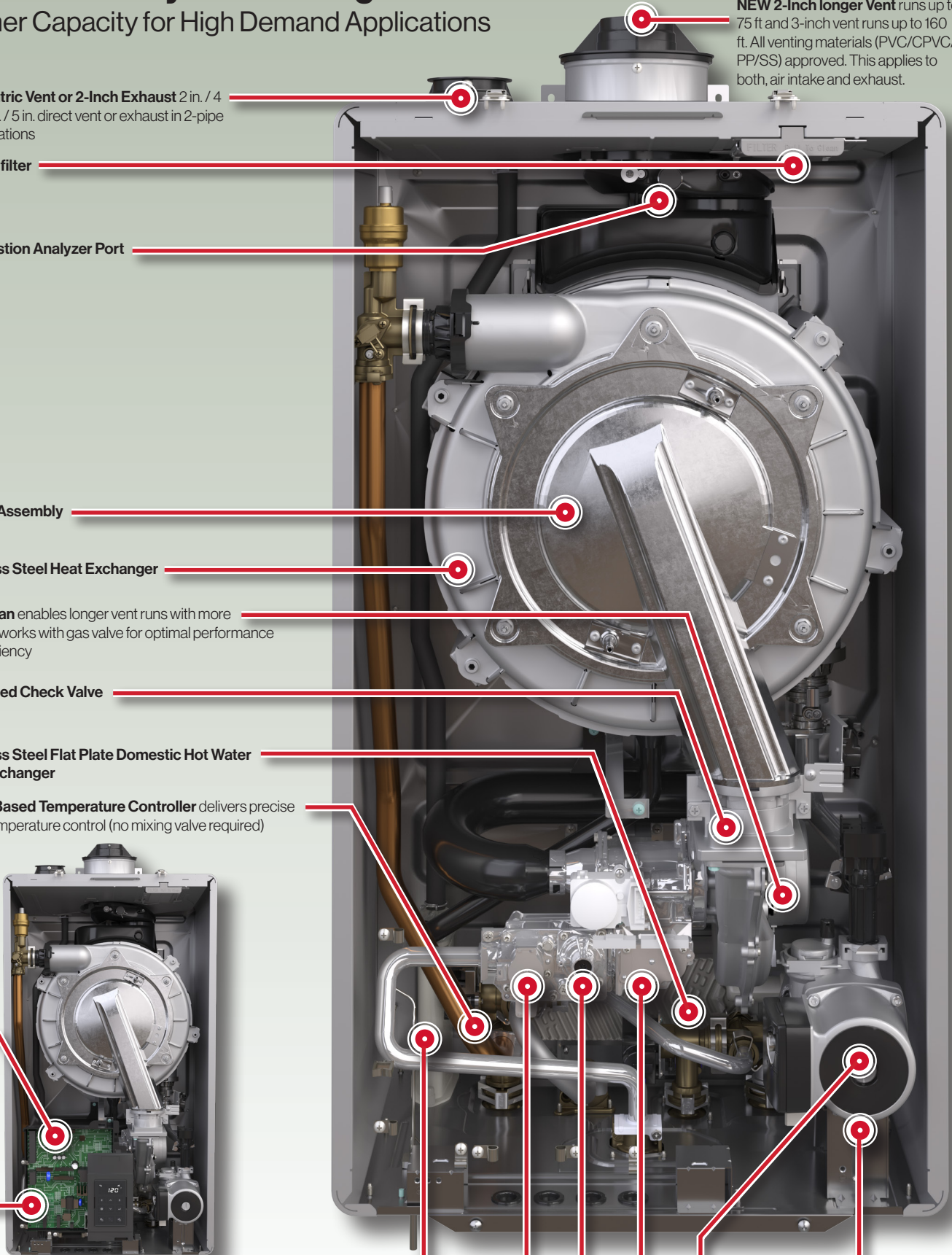

Integrated Condensate Trap to remove acidic condensate

Zero Governor Gas Valve

Switch Venturi

Gas Orifice

Integrated Pump (Combi Models Only)

Proportional Valve allows Simultaneous Space Heating (SH) and Domestic Hot Water (DHW) (located behind the Pump)

I-SERIES PLUS™

Condensing Gas Boiler
175 and 199k Btu Models

Solo Models

Pressure Drop and Water Flow

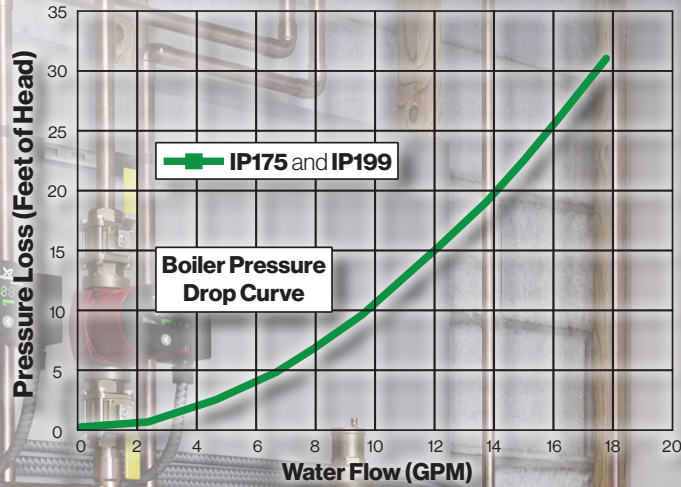

Note: External boiler pump required

Combi Models

Pressure Drop and Water Flow

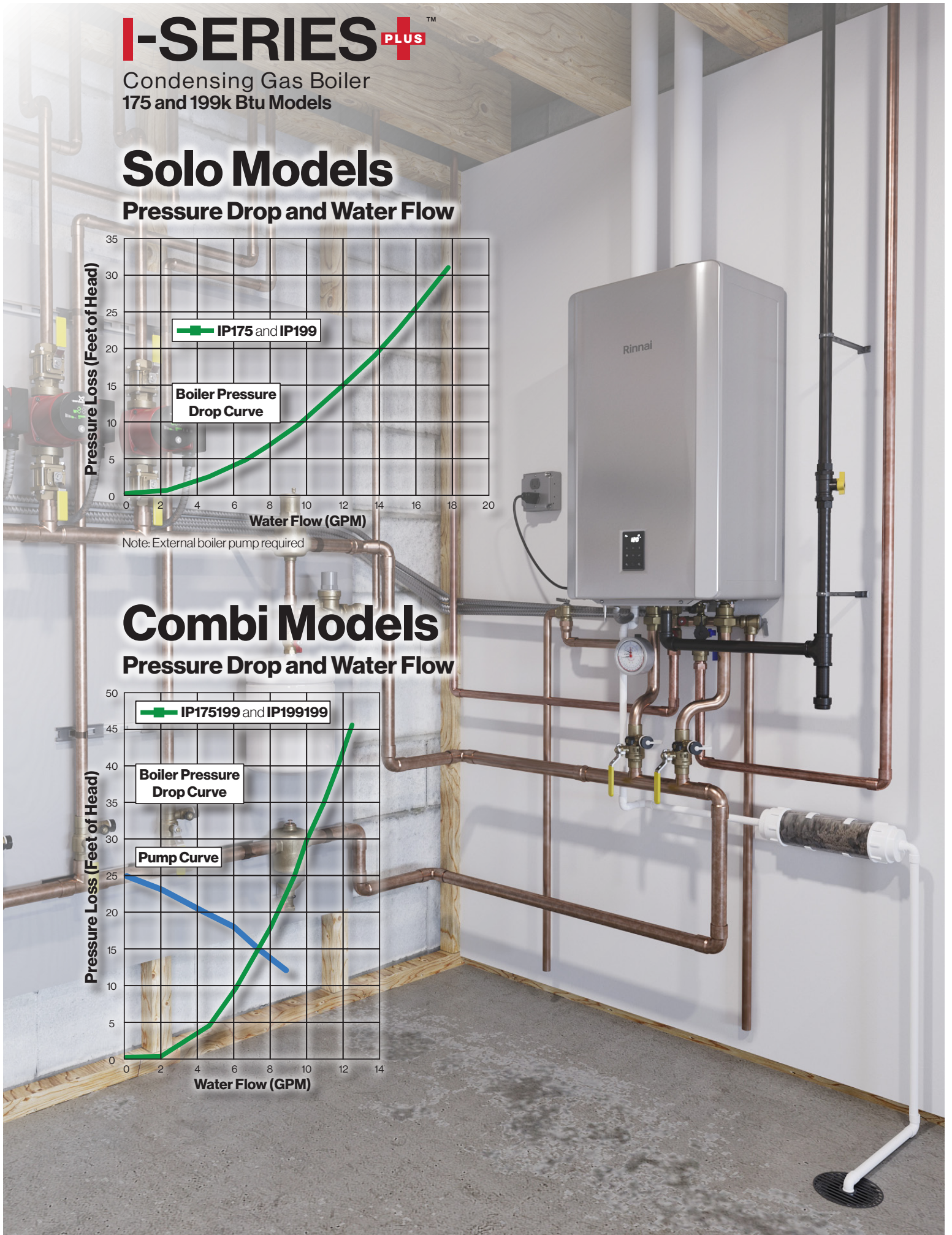
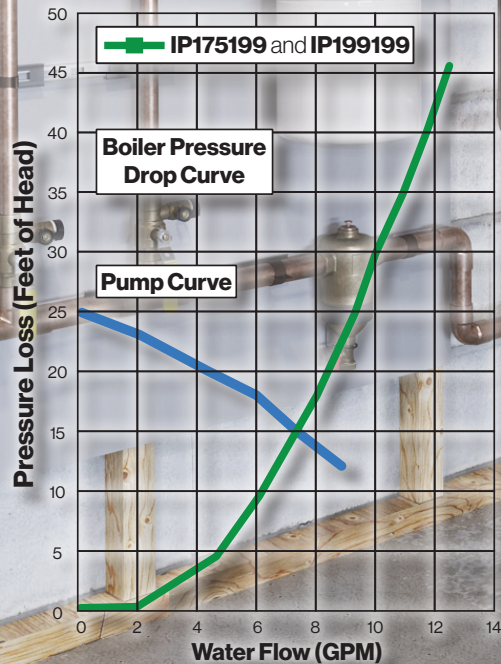



I-SERIES Plus™ Combi Models



Rinnai® I-SERIES PLUS™ Condensing Gas Boiler



Specifications	Combi Models								
	IP060160C	IP090099C	IP090160C	IP090199C	IP120199C	IP150199C	IP175199C	IP199199C	
Heating Input Max CH (Btu)	60,000	90,000	90,000	90,000	120,000	150,000	175,000	199,000	
Heating Input Min CH (Btu)	15,000								
Heating Input Max DHW (Btu)	160,000	99,000	160,000	199,000	199,000	199,000	199,000	199,000	
Efficiency (% AFUE)	95.5	96.0	96.0	96.0	96.0	96.0	95.0	95.0	
Turndown Ratio (TDR)	11:1	7:1	11:1	13:1	13:1	13:1	11:1	10:1	
Turndown Ratio (TDR) CH	4:1	6:1	6:1	6:1	8:1	10:1	10:1	10:1	
DHW Max Flow Rate (GPM)	7.9	5.3	7.9	9.8		7.9	9.8		
Flow Rate at 70°F (39°C) Rise	4.1			5.1			4.1	5.1	
Fuel Type	NG/LP	NG/LP	NG/LP	NG/LP	NG/LP	NG/LP	NG/LP	NG/LP	
Heat Exchanger Surface Area (sqft)	9.3			10.9			15.6		
Temperature Setting Range (CH)	86°F - 180°F (30°C - 82°C)						86°F - 180°F (30°C - 82°C)		
Water Content (Gal)	0.75			0.88			2.4		
Max Water Operating Pressure (CH)	30 PSI (207 kPa)								
Gas Supply Pressure (Natural Gas)	3.5 - 10.5 in W.C. (0.87 - 2.61 kPa)								
Gas Supply Pressure (Propane)	8.0 - 13.5 in W.C. (1.99 - 3.36 kPa)								
Electrical Data	Normal CH)	207 W						207 W	
	Standby	8 W						8 W	
	Max Current	14 Amps						14 Amps	
Sound Level dB(A)	43						42		
Weight	Unit	73.0 lb (33.0 kg)			76.1 lb (34.5 kg)			123.5 lb (56 kg)	
	Shipping	79.4 lb (36.1 kg)			82.7 lb (37.6 kg)			138.6 lb (63 kg)	
Dimensions W x H x D in. (mm)	Unit	18.5 x 26.4 x 11.45 (471 x 671 x 290)						19.45 x 34.88 x 15.48 (494 x 886 x 393)	
	Shipping	20.9 x 33.5 x 14.6 (532 x 852 x 370)						23.6 x 45.3 x 19.7 (600 x 1,150 x 500)	
Residential Warranty (Heat Exchanger)							12 Years		
Residential Warranty (Parts)							5 Years		
Residential Warranty (Labor)							1 Year		
Commercial Warranty (Heat Exchanger)	5 Years								
Commercial Warranty (Parts)	5 Years								
Commercial Warranty (Labor)	1 Year								
Certifications									

1. Ratings are the same for natural gas models and converted to propane gas.
 2. Values are based standard test procedures prescribed by the U.S. Department of Energy..



3. The net AHRI ratings are based on piping and pickup allowances of 1.15. Please contact Rinnai for selecting boilers that have unusual piping or system components.
 4. Rinnai reserves the right to change specifications without notice.

I-SERIES Plus™ Solo Models



Rinnai® I-SERIES PLUS™ Condensing Gas Boiler



Specifications		Solo Models					
		IP060S	IP090S	IP120S	IP150S	IP175S	IP199S
Heating Input Max CH (Btu)		60,000	90,000	120,000	150,000	175,000	199,000
Heating Input Min CH (Btu)		15,000					
Heating Input Max DHW (Btu)		N/A					
Efficiency (% AFUE)		95.5	96.0	96.0	96.0	95.0	95.0
Turndown Ratio (TDR)		N/A					
Turndown Ratio (TDR) CH		4:1	6:1	8:1	10:1	10:1	10:1
DHW Max Flow Rate (GPM)		N/A					
Flow Rate at 70°F (39°C) Rise		N/A					
Fuel Type		NG/LP	NG/LP	NG/LP	NG/LP	NG/LP	NG/LP
Heat Exchanger Surface Area (sqft)		9.3		10.9		15.6	
Temperature Setting Range (CH)		86°F - 180°F (30°C - 82°C)					
Water Content (Gal)		0.75		0.88		2.4	
Max Water Operating Pressure (CH)		30 PSI (207 kPa)					
Gas Supply Pressure (Natural Gas)		3.5 - 10.5 in W.C. (0.87 - 2.61 kPa)					
Gas Supply Pressure (Propane)		8.0 - 13.5 in W.C. (1.99 - 3.36 kPa)					
Electrical Data	Normal CH)	36 W	53 W	50 W	50 W	90 W	98 W
	Standby	8 W				8 W	
	Max Current	14 Amps				14 Amps	
Sound Level dB(A)		40	40	40	42	40	42
Weight	Unit	62.6 lb (28.4 kg)		64.8 lb (29.4 kg)		112.4 lb (51 kg)	
	Shipping	69.1 lb (34.1 kg)		71.3 lb (32.4 kg)		127.6 lb (58 kg)	
Dimensions W x H x D in. (mm)	Unit	18.5 x 25.75 x 11.5 (470 x 654 x 291)				19.45 x 34.88 x 15.48 (494 x 886 x 393)	
	Shipping	20.9 x 33.5 x 14.6 (532 x 852 x 370)				23.6 x 45.3 x 19.7 (600 x 1,150 x 500)	
Residential Warranty (Heat Exchanger)						12 Years	
Residential Warranty (Parts)						5 Years	
Residential Warranty (Labor)						1 Year	
Commercial Warranty (Heat Exchanger)		5 Years					
Commercial Warranty (Parts)		5 Years					
Commercial Warranty (Labor)		1 Year					
Certifications							





1. Ratings are the same for natural gas models and converted to propane gas.
2. Values are based standard test procedures prescribed by the U.S. Department of Energy.
3. The net AHRI ratings are based on piping and pickup allowances of 1.15. Please contact Rinnai for selecting boilers that have unusual piping or system components.
4. Rinnai reserves the right to change specifications without notice.

Additional Accessories







Part Number	Description	
807000212	Primary-secondary heating Kit, I-Series Boiler (Combi Models only)	
807000213	Primary-secondary heating Kit, I-Series Boiler (Heat only)	
804000074	Condensate Neutralizer Kit (All Models)	
809000114	Refill - Condensate Neutralizer (All Models)	
103000038	Scale Cutter System (Combi Models only)	
103000039	Scale Cutter Refill Cartridge (Combi Models only)	
MIVK-T-LW	DHW Isolation Valve Kit, Compact design, Ease in Flushing (Combi Models only)	
MC-601	Temperature Controller (Combi Models only)	
RTBRACKA	Boiler rack, standard height	
RTBRACKS	Boiler rack, low profile	
RTBRACKEXT	Rack extension kit, add-on	

Installation and Venting Components



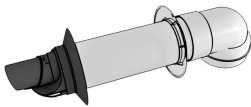









2in. Venting for Room Air and Twin Pipe

Part Number	Description	Inner Exhaust Material	Outer Intake Material	
222715NPP	2 in. Condensing Fixing Clip Metal Qty 10	PP	Plastic	
223085NPP	2 in. Condensing Wall Terminal Twin Pipe	PP	Plastic	
222710NPP	2 in. Condensing 45 Degree Elbow (20/ Box)	PP	Plastic	
222711NPP	2 in. Condensing 90 Degree Elbow (20/ Box)	PP	Plastic	
222712NPP	2 in. Condensing Vent Pipe Extension 39 in. (4/ Box)	PP	Plastic	
222714NPP	2 in. Condensing Vent Pipe Extension 79 in. (4/ Box)	PP	Plastic	

2in. / 4in. Installation Venting Components

Part Number	Description	Inner Exhaust Material	Outer Intake Material	
710202NPP	2 in. / 4 in. Condensing 90 Degree Diverter Nose	PP	Plastic	
710215NPP	2 in. / 4 in. Condensing 45 Degree Diverter Nose	PP	Plastic	
229011NPP	2 in. / 4 in. Condensing Horizontal Termination Kit 8.7 in.	PP	Plastic	
229012NPP	2 in. / 4 in. Condensing Horizontal Termination Kit 12 in.	PP	Plastic	
229013NPP	2 in. / 4 in. Condensing Horizontal Termination Kit 21 in.	PP	Plastic	
229016NPP	2 in. / 4 in. Condensing 21 in. Wall Term w/2 wall plates	PP	Plastic	
224356NPP	2 in. / 4 in. Condensing Roof Discharge Term 20 in. Above Roof	PP	Plastic	
229205NPP	2 in. / 4 in. Condensing 45 Degree Elbow Qty 2	PP	Plastic	
229230NPP	2 in. / 4 in. Condensing 90 Degree Elbow Qty 2	PP	Plastic	

Additional Accessories

Part Number	Description		
146141	Roof Flashing Assembly (flat roof)	Suitable for use with plastic and metal components	
189950	Shingle Roof Flashing (1/12 to 6/12 pitch; plastic)		
189951	Shingle Roof Flashing (6/12 to 12/12 pitch; plastic)		
189952	Shingle Roof Flashing (8/12 to 16/12 pitch; plastic)		
50171949	Tile/Shingle Roof Flashing (1/12 to 6/12 pitch; metal)		
50171961	Tile/Shingle Roof Flashing (6/12 to 12/12 pitch; metal)		
50171954	Tile/Shingle Roof Flashing (8/12 to 16/12 pitch; metal)		
242141	Flashing for Metal Roof		
710342	Rubber Wall Plate (white)		
710602	Rubber Wall Plate (black)		
224045	Thimble (1 piece per box)		
169044	Universal Pipe Clamp - Plastic		
224097	Metal Pass Through Plate	-	
224042	Universal Bug Guard		



I-SERIES⁺ PLUSTM

Condensing Gas Boiler

Rinnai offers the
most models with an
industry-leading
96% AFUE*

*AHRI Directory of Certified Product Performance







IP060160C Combi Model





IP199S Solo Model

Installation and Venting Components



2in. / 4in. Installation Venting Components

Part Number	Description	Inner Exhaust Material	Outer Intake Material	
229253NPP	2 in. / 4 in. Condensing Horizontal Starter Adapter	PP	Plastic	
229308NPP	2 in. / 4 in. Condensing Vent Pipe Extension 10 in.	PP	Plastic	
229309NPP	2 in. / 4 in. Condensing Vent Pipe Extension 19.5 in.	PP	Plastic	
229310NPP	2 in. / 4 in. Condensing Vent Pipe Extension 39 in.	PP	Plastic	
227412NPP	2 In. / 4 In. Condensing Vertical Starter Adapter	PP	Plastic	
185348NPP	2 in. / 4 in. Condensing Roof Term Extension Kit	PP	Plastic	

3in. Venting Components

Part Number	Description	Inner Exhaust Material	Outer Intake Material	
196116PVC	3 in. Concentric PVC	PVC	PVC	
196985PVC	Condensing Horizontal Vent Termination, 3" PVC Low Profile Flush Mount	PVC	PVC	

IPEX Venting Components

Part Number	Description	Inner Exhaust Material	Outer Intake Material	
196005PVC	IPEX 2 in. Concentric Termination 2 x 16	PVC	PVC	
196105PVC	IPEX 2 in. Concentric Termination 2 x 28	PVC	PVC	
196125PVC	IPEX 2 in. Concentric Termination 2 x 40	PVC	PVC	
192984PVC	IPEX PVC Low Profile Termination 2 in.	PVC	PVC	

Additional push button and motion sensors can be purchased separately to customize a recirculation system

Accessories

3in. / 5in. Installation Venting Components

Part Number	Description	Inner Exhaust Material	Outer Intake Material	
223174PP	Condensing Horizontal Termination Kit • 8.7" / 220.9 mm	PP	Plastic	
223176PP	Condensing Horizontal Termination Kit • 12" / 304.8 mm	PP	Plastic	
223177PP	Condensing Horizontal Termination Kit • 21" / 533.4 mm	PP	Plastic	
223186PP	Condensing Horizontal Termination Diverter Kit • 19" / 482.6 mm	PP	Plastic	
184162PP	Condensing Roof Discharge Termination Short (above roof) 38" / 965.2 mm	PP	Plastic	
224047PP	Condensing Raised Horizontal Termination Kit (Snorkel)	PP	Plastic	
185344PP	3"/5" Roof Termination Extension Kit	PP	Plastic	
185346PP	3"/5" Condensing Termination Extension	PP	Plastic	
185347PP	3"/5" Separation Kit	PP	Plastic	
187585PP	Twin Pipe Adapter for use w/ PVC/CPVC (Special Order Only)	PP	Plastic	-
224077PP	45-Degree Elbow (Quantity of 2)	PP	Plastic	
224078PP	90-Degree Elbow	PP	Plastic	
224087PP	Vent Pipe Extension • 10" / 254 mm	PP	Plastic	
224079PP	Vent Pipe Extension • 19.5" / 495.3 mm	PP	Plastic	
224080PP	Vent Pipe Extension • 39" / 990.6 mm	PP	Plastic	



Termination Kits include elbow and rubber wall plate.

Rinnai®

Over 100 Years of Smart Comfort



With headquarters in Japan and a global network of subsidiaries and sales offices, Rinnai has enhanced the way businesses and residences heat their water.

Dedicated to a smarter kind of comfort, our value-added products continue to stay in step with demands of a changing world.



Proudly assembling Tankless Water Heaters at our state-of-the-art factory located in Griffin, Georgia, USA

Rinnai established its US operations in 1974 and introduced Tankless Water Heating to the North American Market in 1999.

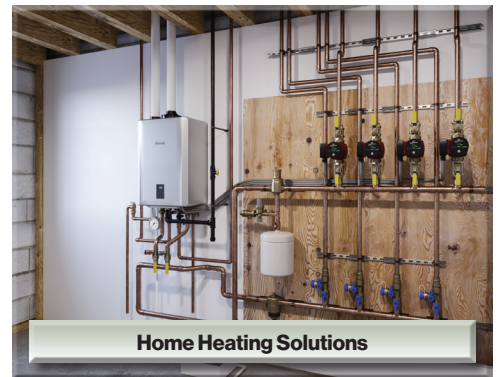

In 2018 Rinnai assembled its first tankless water heater in the United States in Griffin, Georgia. Our state-of-the-art facility was completed in 2021 with assembly of the new **RE•SERIES™ Non-Condensing Tankless Water Heaters** beginning in 2022.

Rinnai continues to make significant investments in expanding its operations and product portfolio.



Creating a healthier way of living.®

Learn more about Rinnai high-performance Tankless Water Heaters, Hybrid Water Heating Systems, Boilers, Vent-Free Fan Convectors, EnergySaver® Direct Vent Wall Heaters, Hydronic Air Handlers, Electric Heat Pump Water Heaters, and Accessories.

rinnai.us | rinnai.ca

Rinnai America Corporation | 103 International Drive | Peachtree City, Georgia 30269 | rinnai.us | rinnai.ca | 1•800•621•9419



Official Water Heater of Tony Stewart Racing

PROUD SPONSOR



FOLDS of HONOR